

**In-Dash Fully Motorized 7" Touch Screen Monitor
TV/FM/AM Receiver/ DVD Player**

Operating manual

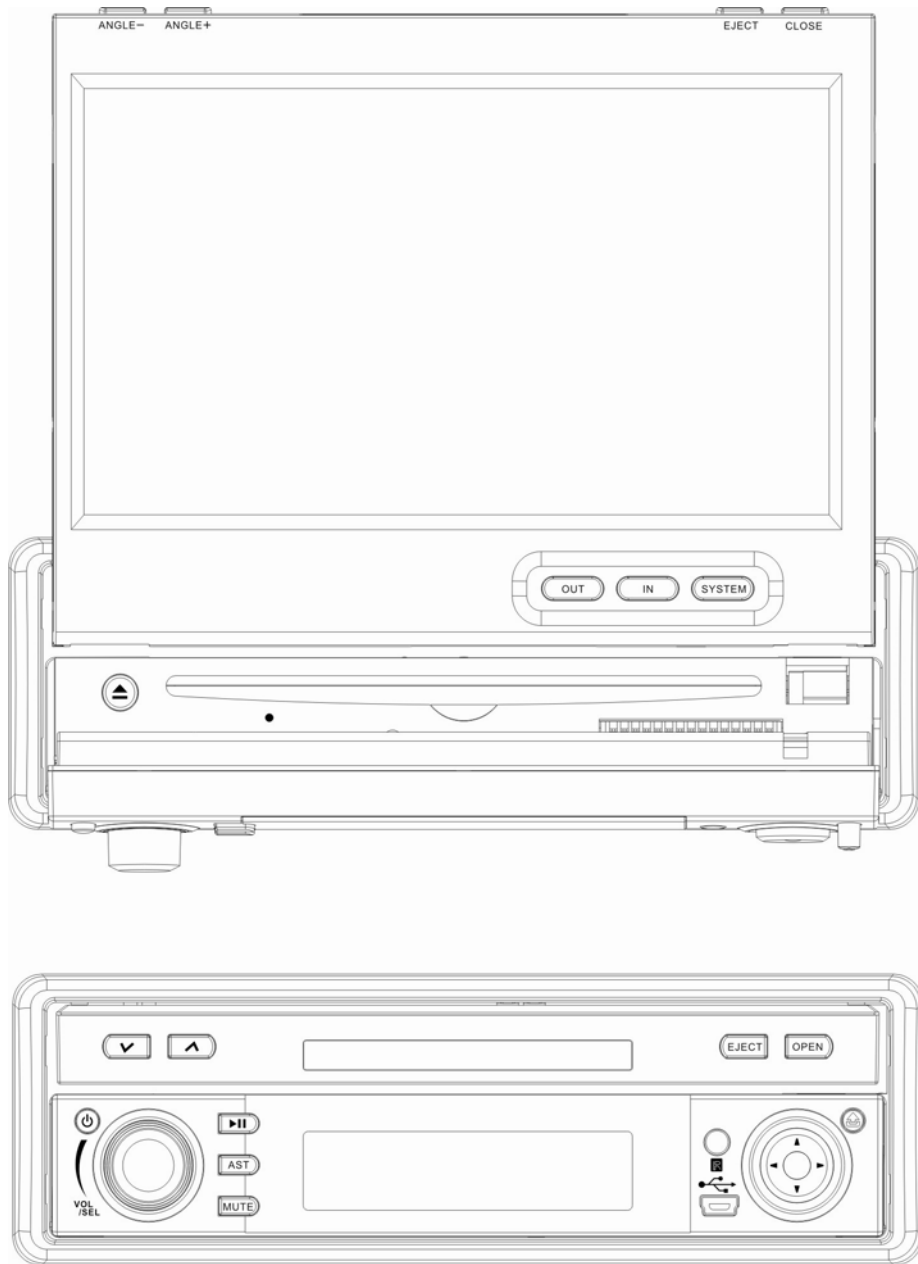

SAFETY INFORMATION

PLEASE READ COMPLETELY AND BECOME FAMILIAR WITH THE CONTENTS OF THIS MANUAL BEFORE INSTALLATION AND OPERATION OF THIS UNIT, AND KEEP IT CAREFULLY FOR FUTURE REFERENCE.

This unit is a class 1 laser product. The laser beam may cause hazardous radiation if exposure to laser system directly. Do not attempt to disassemble the unit personally.

This unit has been designed and manufactured to assure personal safety. Improper use can result in electric shock or fire hazard. The safeguards incorporated in this unit protect you if you observe the following procedures for installation, use and servicing. This unit doesn't contain any parts that can be repaired by the user. If the unit requires maintenance, contact an authorized service center.

Warnings

-Do not expose the product to rain, water or excessive moisture. This could cause electrical shorts, fire or other damage.

-This product is designed to operate with a 12 volt DC, negative ground battery system. Use the proper power supply.

-The monitor is operated automatically. Do not push in or pull out the monitor or try to reverse the monitor manually! Do not attempt to adjust the monitor angle upward or downward manually. It will cause damage to the Monitor Mechanism Structure.

-Do not impact the monitor with a hard object. It may cause permanent damage.

-Do ground all equipments and works in order to avoid causing damage to the unit by electrostatic discharges.

-The user who handles this product takes all necessary precautions to avoid ESD (Electro-Static Discharge) failures.

-Do not attempt to install or service your unit by yourself. Installation or servicing of the unit by persons without training and experience in electronic equipment and automotive accessories may be dangerous and could expose you to the risk of electric shock or other hazards.

Cautions:

- ① To reduce the risk of fire or electric shock, and annoying interference, use only the recommended accessories.
- ① While driving, keep the volume level low enough to be aware of road and traffic conditions.
- ① Parking in direct sunlight can produce very high temperatures inside your vehicle. Give the interior a chance to cool down before starting playback.
- ① Do not use any chemical solvent, cleaning agent or corrosive detergent to clean away dirt on the surface of the TFT monitor screen. It may cause irreversible damage.
- ① Small black and shiny dots inside the liquid crystal panel are normal for liquid crystal product.
- ① In extremely cold temperatures, the movement of the picture may be slow and the picture may be dark, but this is not a malfunction. The unit will work normally once reach its operating temperature.
- ① Do not use and store the unit in dusty, high temperature and high humidity environments.
- ① Do not use the unit immediately when you bring it from cold to warm place. Fast growing temperature, may cause moisture condensing which influence the unit for certain time.

Notes:

- ① **This user's manual only for reference.**
- ① **Modifying rights are reserved.**
- ① **Modifications are subject to change without notice.**

FEATURES

- ISO/1-DIN Size (178mm x 54mm)
- DVD/DVD-R/DVD-RW/VCD/CD/CD-R/CD-RW/MP3 Compatible
- 7" Wide-Screen TFT/LCD Display
- Touch Screen Panel Control
- Graphic User Interface
- High Brightness: 400 cd/m²
- Resolution: 1440 x 234
- Color, Contrast, Brightness, Tint controls
- Fully Motorized Viewing Angle Adjustment
- Last Angle Memory for Panel
- Jumbo Size Front Panel Color LCD Display
- Front Panel Display When the Monitor is Closed
- Drop Down Detachable Front Panel for Invisible DVD Insertion Slot
- Slim Type Car DVD Slot-in Mechanism
- Digital & Mechanical Anti-Shock with ESP Memory
- Built-In Dolby Digital Decoder
- Built-In MP4 Decoder
- Last Position DVD Memory
- OSD (On Screen Display)
- NTSC/PAL Auto / Selectable
- Full Function Remote Control
- IR Repeater
- AM/FM PLL Synthesizer Tuner with 30 Memory Presets
- Auto Store Pre-set Scan
- Preset EQ (POP CLASSIC ROCK JAZZ USER)
- Bass/Treble/Fader/Balance Controls
- Encoder Volume Control
- Extending Amplifier Control
- Auto Antenna Control
- Telephone Mute Control
- Sanyo Compatible CD/DVD Changer Control
- Brake Reminder System
- Digital Clock
- Hi Power 50W x 4
- 4 RCA Audio Outputs
- 1 RCA Sub-Woofer Outputs
- 1 RCA Video Output
- 1 Set RCA Audio Video Input
- 1 RCA Rear View Camera Input
- 3 RCA RGB Inputs for GPS Ready
- Built-In TV Tuner with Diversity Circuitry
- Mini USB
- iPod Input Connection (Cable not Included)

TABLE OF CONTENTS

Safety Information.....	1
Features.....	3
Table of Contents.....	4
Accessories.....	5
Unit Installation.....	6
Unit Removal.....	8
Wiring Connection.....	9
Front Panel.....	12
Remote Control.....	17
Basic Operation.....	21
Touch Screen Operations.....	23
Touch Screen Calibrate.....	23
Main Menu.....	24
Radio Operations.....	25
DVD Operations.....	28
USB Operations.....	30
TV Operations.....	31
iPod Operations.....	32
AV IN Operations.....	34
CDC Operations.....	35
GPS Operations.....	36
System Setup.....	37
DVD Setup Menu.....	40
Troubleshooting.....	46
Specifications.....	49
Disc Notes.....	50

ACCESSORIES

1

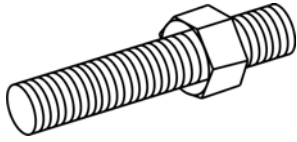

Bolt

2

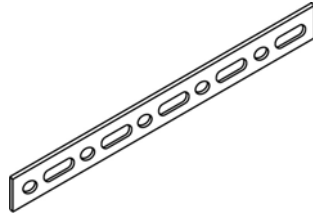

Steel Bar x 1

3



M5X5 Screws x 4

4

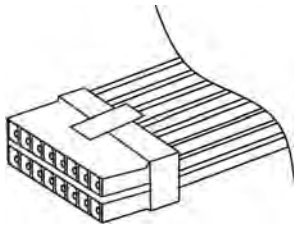

Connector Wire x 1

5

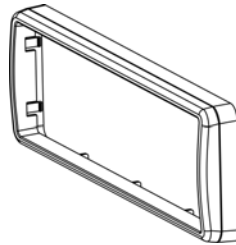

Trim Bezel x 1

6

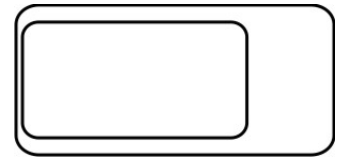

Remote Control x 1

7

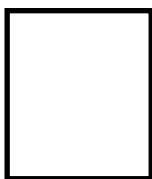

Operational Manual x 1

8

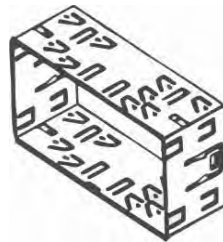

Mounting Sleeve x 1

9

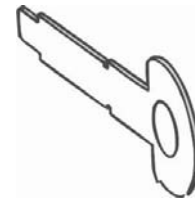

Keys x 2

10

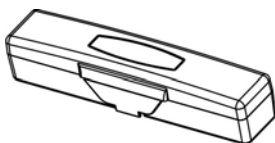

Box x 1

11



Nut M5 x 1

UNIT INSTALLATION

Please read all of the instructions before beginning the installation. Recommend having your unit installed by a professional installation shop.

Tools and Supplies:

You will need these tools and supplies to install your unit:

- Torx type, flat-head and Philips screwdrivers
- Wire cutters and strippers
- Tools to remove existing radio (screwdriver, socket wrench set or other tools)
- Electrical tape
- Crimping tool
- Volt meter/test light
- Crimp connections
- 18 gauge wire for power connections
- 16~18 gauge speaker wire

Warnings:

Choose the mounting location where the unit will not interfere with the safe driving conditions.

Install the unit where it does not get in the driver's way and can not injure the passenger if there is a sudden stop, like an emergency stop.

Avoid installing the unit where it would be subject to high temperature, such as from direct sunlight, or from hot air, from the heater, or where it would be subject to dust, dirt or excessive vibration.

Cautions:

Before finally installing the unit, connect the wiring temporarily and make sure it is all connected up properly, the unit and the system work properly.

Use only the parts included with the unit to ensure proper installation. The use of unauthorized parts can cause malfunctions.

Consult with your nearest dealer if installation requires the drilling of holes or other modifications of the vehicle.

If installation angle exceeds 30 degrees from horizontal, the unit might not give its optimum performance.

- Securing the Unit to the Mounting Bracket.

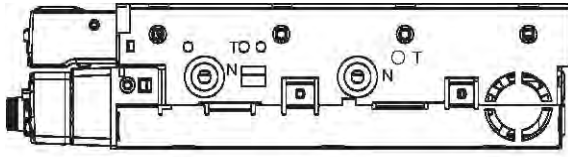

Installation Method

1. Install the front panel into the unit.

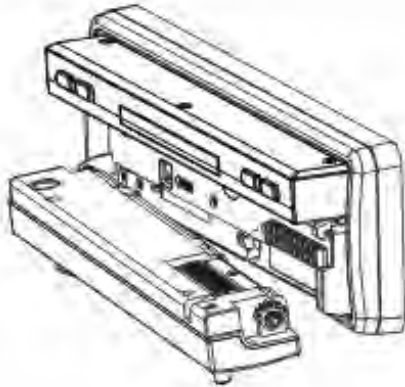

2. Bend the claws outward for tight fit, if necessary. Install the Mounting Box into the dashboard, tighten the unit in place.

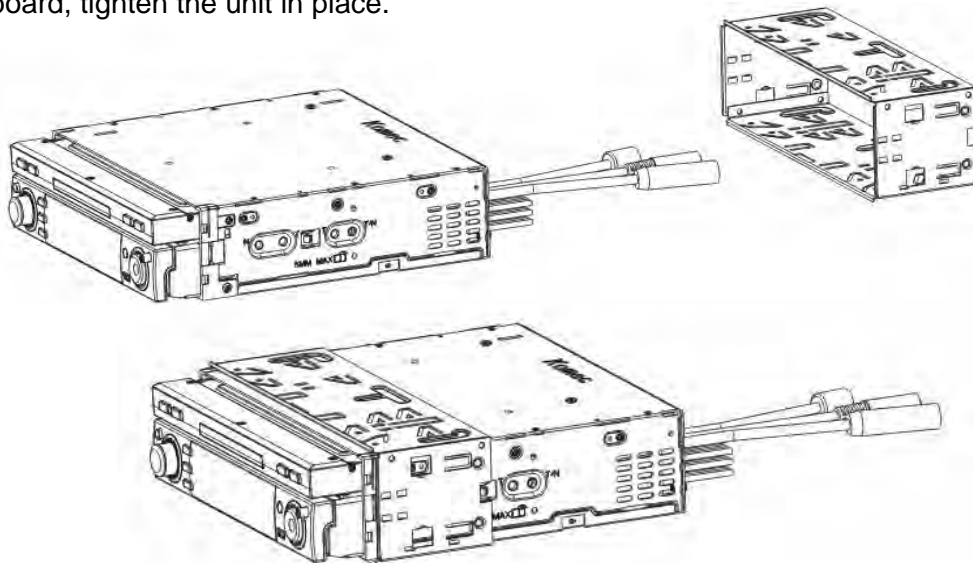

3. Install the Frame to the unit.

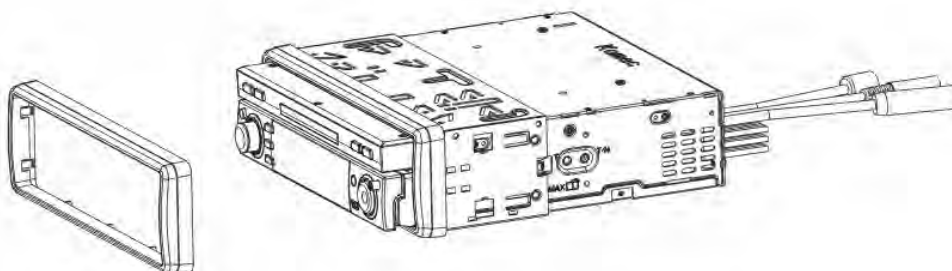

UNIT REMOVAL

1. Detach the front panel.

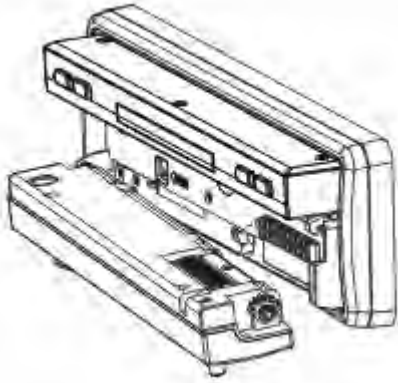

2. Insert the keys that supply to the unit at both sides of the unit (shown as illustrated) until pull the keys to make it possible to remove the unit from the dashboard.

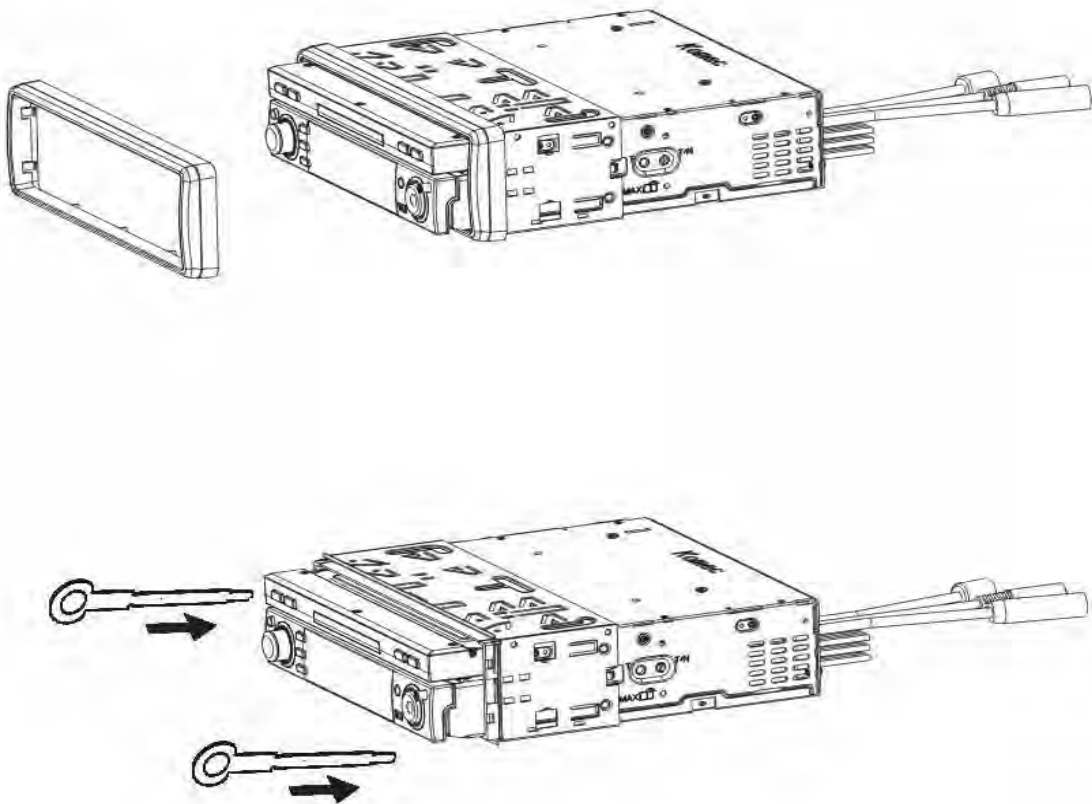

WIRING CONNECTION

Cautions:

- To prevent short circuits, remove the key from the ignition and disconnect the terminal of the battery.
- Make the proper input and output cable connections for each unit.
- Connect the wiring harness cables in the following order: ground wire, battery wire, ignition wire.
- Reconnect the terminal of the battery.
- Do not connect the yellow wire of this product directly to the battery terminal.
- Do remember to connect the red wire of this product to the ACC. of the ignition key switch. Failure to do may result in draining off the battery charge prematurely.
- If the fuse blows, first make sure that the cables have not caused a short circuit, then replace the old fuse with new one with the same rating.
- Do not let unconnected cables or terminals touch the metal on the car or other conductor.
- To prevent short circuits, do not remove the caps from unused terminals or from the ends of the unconnected cables.
- After the monitor unit is installed, check whether the brake lamps, blinkers, wiper, etc. on the vehicle are working properly. If not, please make sure they are properly installed.
- Insulate unconnected wires with vinyl tape or other similar material.

Disconnecting the Battery

To prevent a short circuit, be sure to turn off the ignition and remove the negative (-) battery cable prior to installation.

Reconnecting the Battery

When wiring is complete, reconnect the battery negative terminal.

Warning:

Be sure to use the correct type and amperage Fuse to avoid damaging the unit.

Fuse of the Battery wire in Main Unit: 1 amp;

Fuse of the ACC wire in Main Unit: 1 amp;

Wiring Diagram

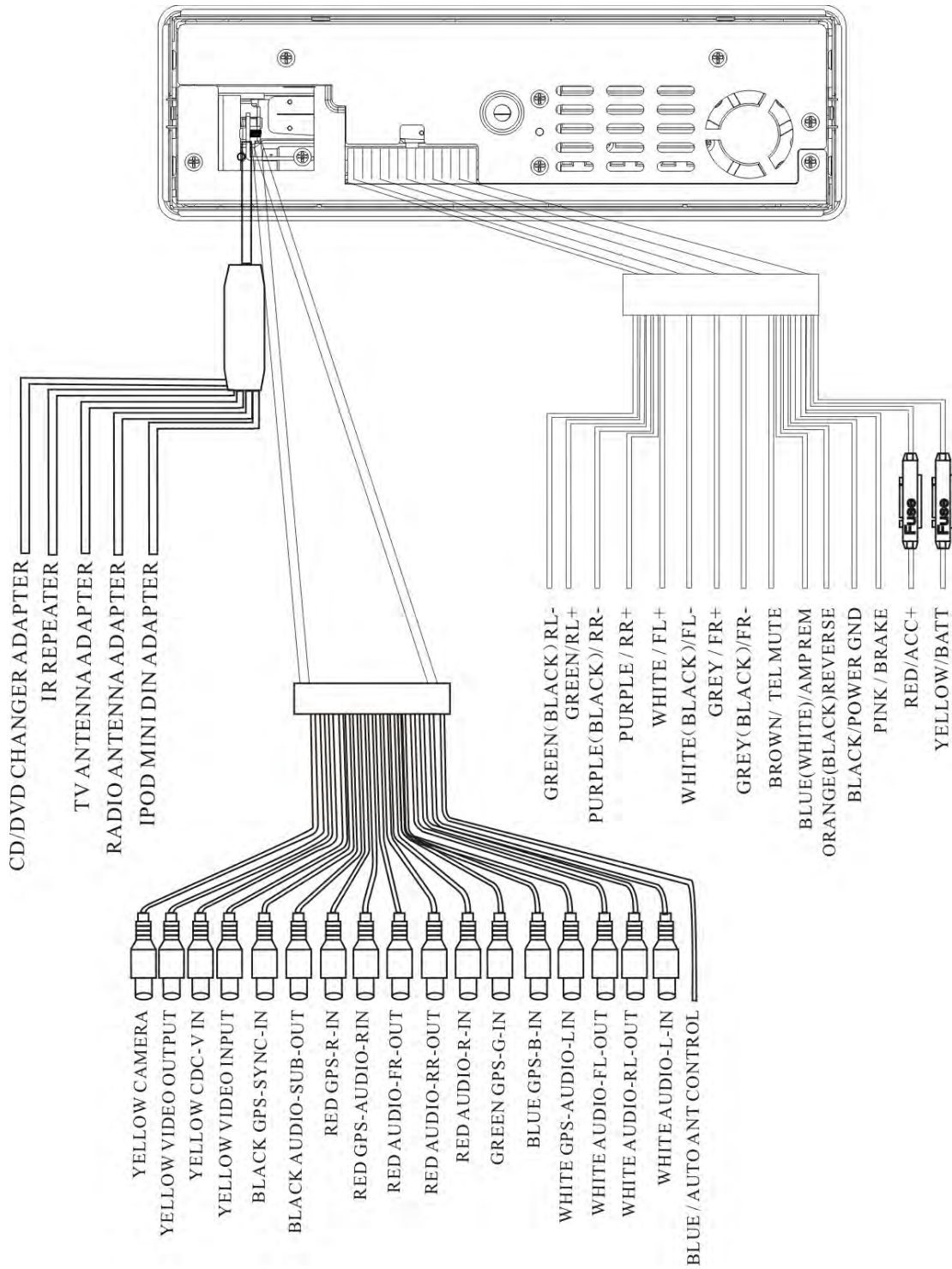

Notes:

-If the TV antenna is mounted near a radio antenna, reception quality may be affected during simultaneous reception of TV and Radio broadcasts.

-Please separate Battery Units before setting products to prevent from fire and electric shock. Mounting the antenna near to a radio antenna will result in noise. In this case, consult your dealer concerning mounting location.

Wiring Diagram

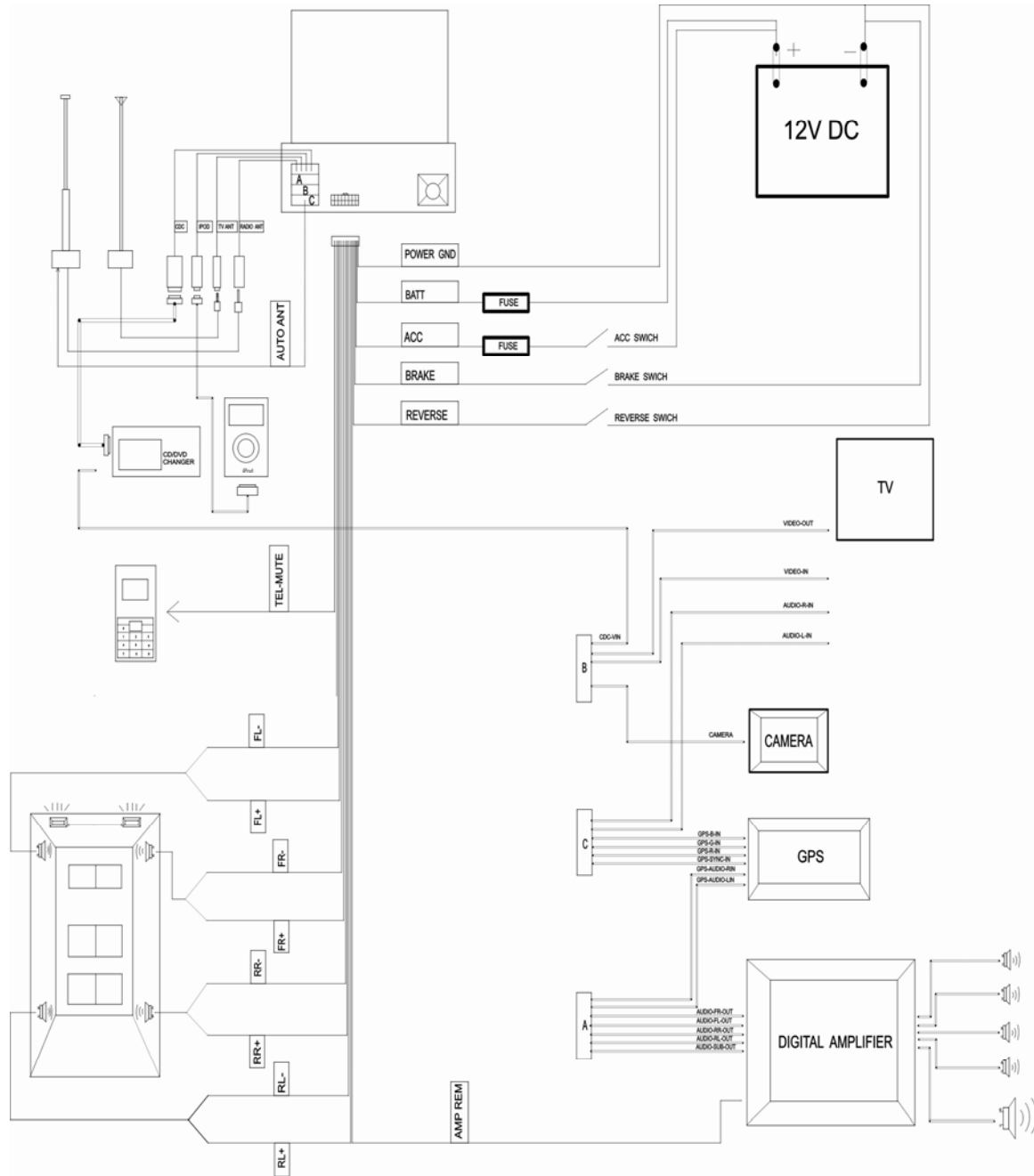

FRONT PANEL

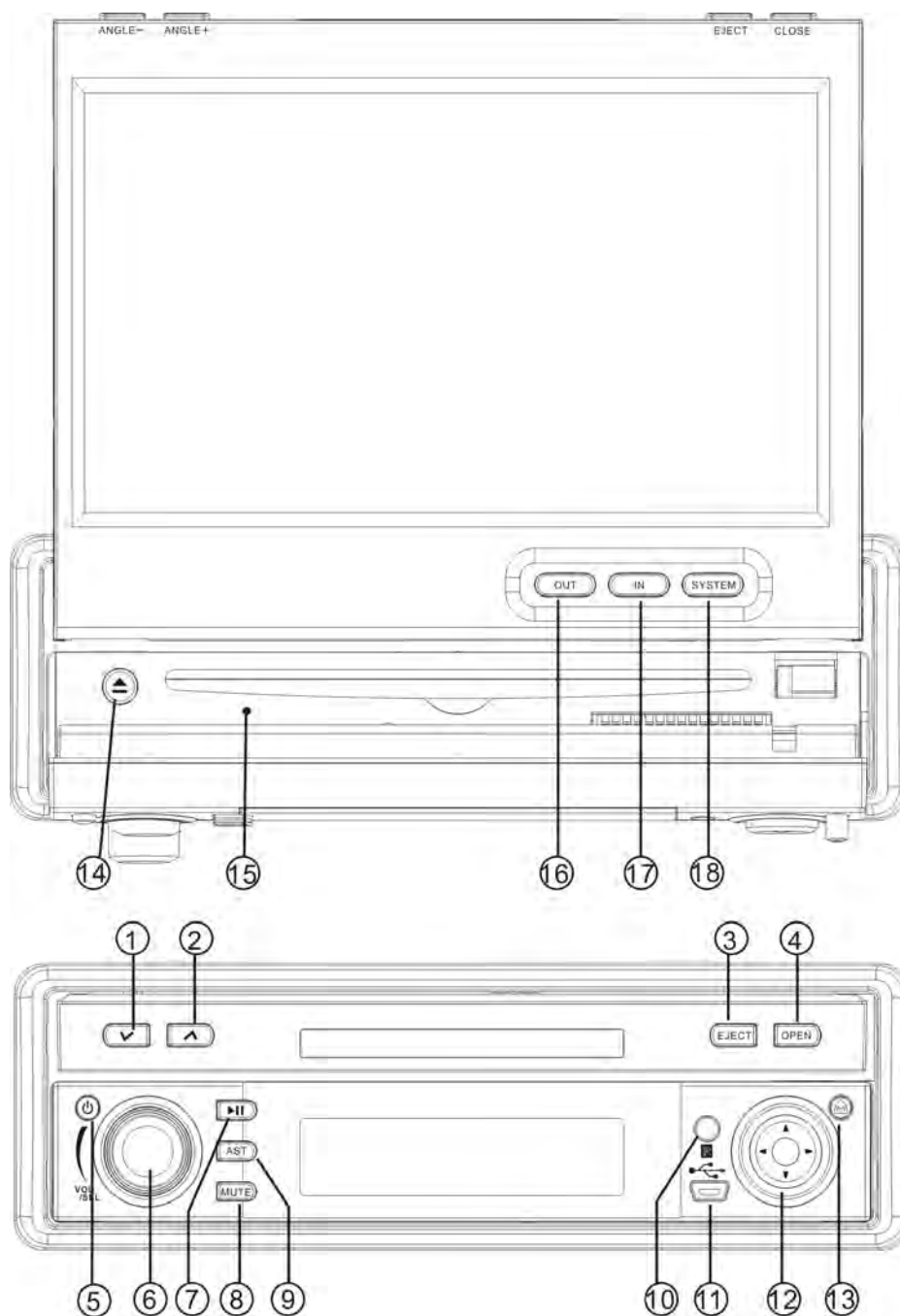

- | | |
|--------------------------|--|
| 1. ANGLE - | 10. REMOTE |
| 2. ANGLE + | 11. MINI USB |
| 3. EJECT | 12. LEFT / UP / RIGHT / DOWN / ENTER / BAND |
| 4. OPEN / CLOSE | 13. REL |
| 5. POWER / SOURCE | 14. EJECT |
| 6. VOLUME / SEL | 15. RESET |
| 7. PLAY / PAUSE | 16. OUT |
| 8. MUTE | 17. IN |
| 9. AST | 18. SYSTEM |

1. [ANGLE -] / 2. [ANGLE +]

Adjust the view angle of the monitor to choose the best displaying effect.

1- Continual angle adjustment

Hold on pressing the [ANGLE +] / [ANGLE -] buttons to adjust the angle of TFT monitor upward / downward by continual increasing / decreasing.

2- Single step angle adjustment

Press the [ANGLE +] / [ANGLE -] buttons to adjust the angle of TFT monitor upward / downward by singly increasing / decreasing.

3. [EJECT]

When flip down the front panel, press to eject / load a disc.

4. [OPEN] / [CLOSE]

When unit power off, press the [OPEN] button to turn unit on and the monitor will spread out and turn around to the last angle position.

When unit power on, press to open / close the Monitor.

1- Open the TFT Monitor

Press the [OPEN] button, the monitor will spread out and turn around to the last angle position.

2- Close the TFT Monitor

Press the [CLOSE] button, the monitor will turn downward and completely retract in.

5. [POWER/SOURCE]

Press the [POWER/SOURCE] button to turn the unit ON;

Hold on pressing the button to turn the unit OFF.

When the unit in turned ON, press the [POWER/SOURCE] button to toggle between the different modes as following:

RADIO – TV – IPOD – CDC – AV IN – GPS – DVD – USB – RADIO

NOTE

The unit could be switched to DVD Mode if disc inside;

The unit could be switched to USB Mode if Mini USB connected;

The unit could be switched to IPOD Mode if iPod connected;

The unit could be switched to CDC Mode if CD/DVD changer connected;

The unit could be switched to GPS Mode if GPS connected;

6. [VOL/SEL]

Rotate the button clockwise / anticlockwise to increase / decrease the volume.

Press the button vertically to enter the EQ setting as following:

USER – POP – CLASSIC – ROCK – JAZZ – USER

7. [MUTE]

Press the [MUTE] button to switch off the sound; press it again to resume to the previous volume level.

8. [AST]

Press to seek radio station / TV channel automatically under RADIO / TV Modes.

9. [▶II]

Press to pause playback when playing; press again to continue playing.

10. REMOTE

Infrared Remote Receiver.

11. MINI USB

The unit will be switched to DVD Mode automatically when USB connected, and play the songs, pictures, videos in USB.

12. LEFT / UP / RIGHT / DOWN / ENTER / BAND

Under the DVD Setup menu:

Press the [▼] / [▲] buttons to move the cursor upward / downward to select item.

Press the [←] / [→] buttons to move the cursor leftward / rightward to select item.

Press vertically to confirm the operation.

Under RADIO Mode:

Press the [←] / [→] buttons to decrease / increase the frequency step by step.

Hold on pressing the [←] / [→] buttons to fast seeking the next available channel by decreasing / increasing the tuning frequency; seeking will stop by pressing any button.

Press the [▼] / [▲] buttons to switch the stored stations.

Hold on pressing the [▼] / [▲] buttons to fast seeking by decreasing / increasing the tuning frequency; seeking will stop when loose the button.

Press vertically to switch the FM/AM wave band as following:

FM1 - FM2 - FM3 - AM1- AM2 - FM1

Under TV Mode:

Hold on pressing the [←] / [→] buttons to fast tuning channel forward the low / high frequency automatically.

Press the [▲] / [▼] buttons to select the stored channel upward / downward.

Hold on pressing vertically to switch the TV area as following:

US – CCIR – IT – AUSTRALIA – NZ – US

Press vertically to switch the SIF (Sound Intermediate Frequency) as following:

PAL– I – PAL– DK – PAL– BG – PAL– I

NOTE:

No functions under US TV area.

13. REL

Press to flip down the front panel.

14. [EJECT]

When flip down the front panel, press to eject / load a disc.

15. [RESET]

Press to reset the unit.

16. [OUT] / 17. [IN]

Press the [OUT] / [IN] buttons to move the monitor forward / backward by singly step. There are 4 steps to move the monitor forward / backward totally.

18. [SYSTEM]

Press to enter / exit the System Parameter Setup menu.

FRONT PANEL DISPLAY

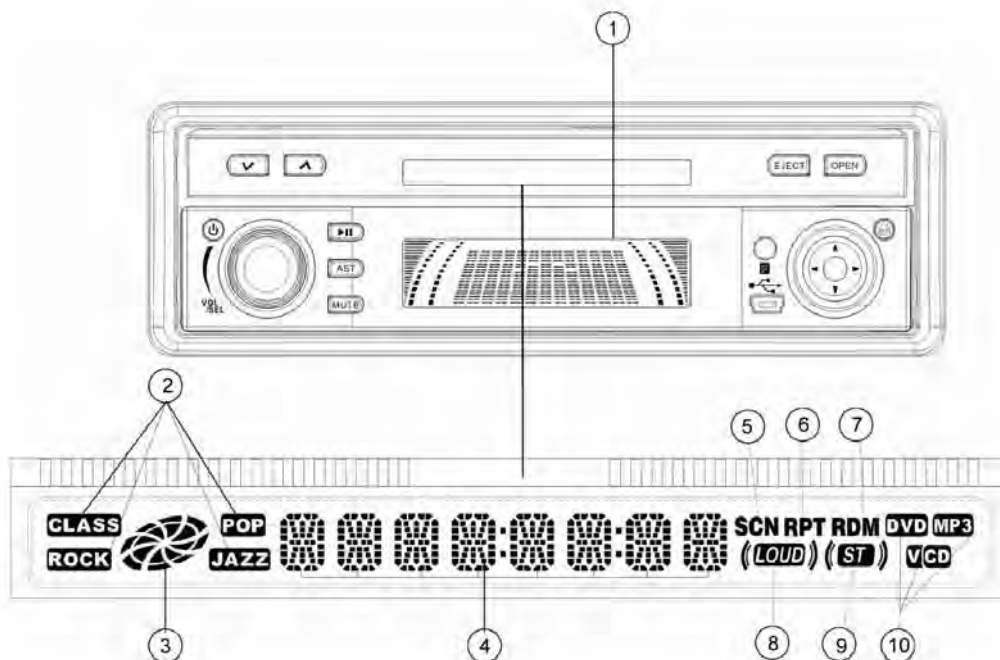

1, Spectrum

This is the truly five bands spectrum display.

2. EQ Indicator:

It turns on to indicate the POP/CLASSIC/JAZZ/ROCK when corresponding setup. It turns off when custom setup.

3. Disc Icon:

It rotates when playing disc under the DVD Mode.

4. Main Display Area:

Display the information such as working mode, characters, playback time & number of track, radio frequency, TV channel etc.

5. SCN Icon:

It displays when the AST function on.

It disappears when the AST function off.

6. RPT Icon:

It displays when the REPEAT function on.

It disappears when the REPEAT function off.

7. RDM Icon:

It displays when the RANDOM function on.

It disappears when the RANDOM function off.

8. LOUD Icon:

It displays when the LOUD function on.

It disappears when the LOUD function off.

9. ST Icon:

It displays when the STEREO function on.

It disappears when the STEREO function off.

10. Disc Type Indicator:

It turns on to indicate DVD, CD, VCD, and MP3 when playing corresponding discs.

REMOTE CONTROL

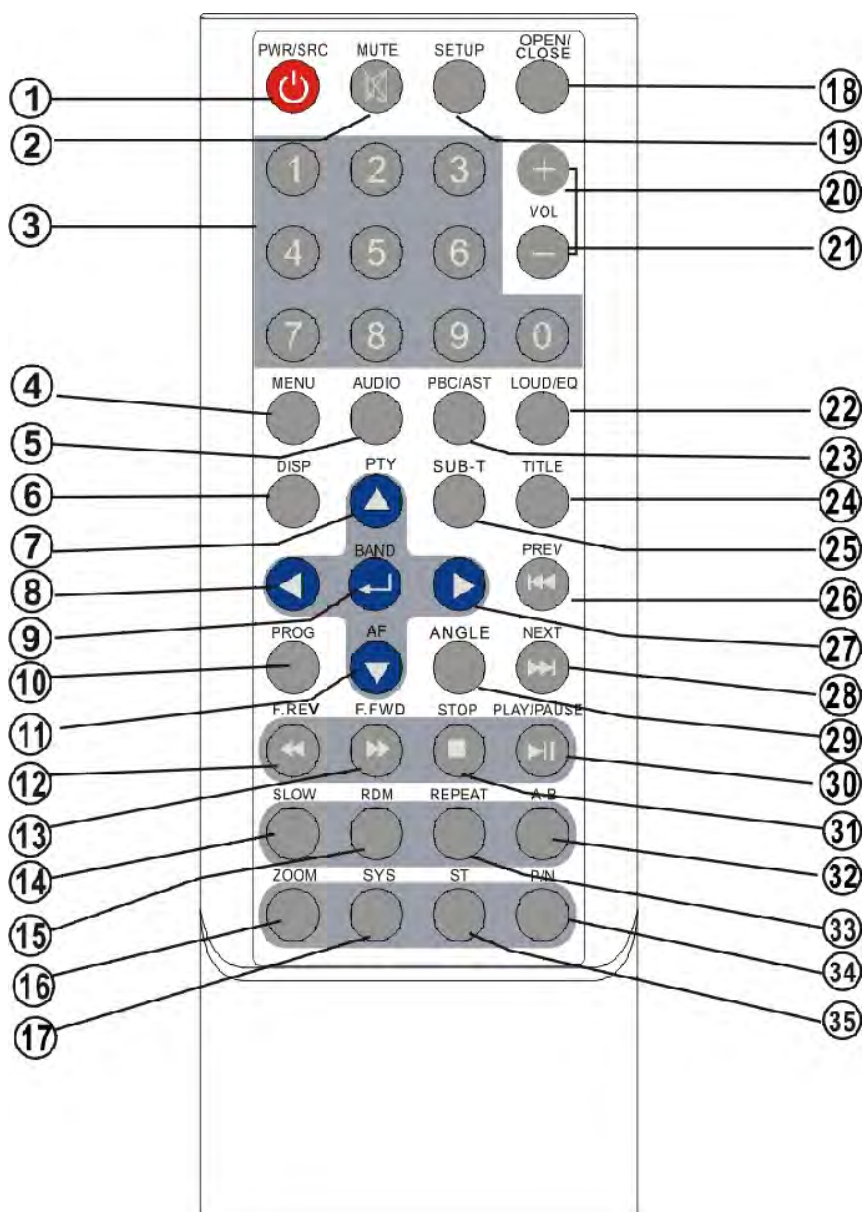

1. POWER / SOURCE
2. MUTE
3. NUMBER BUTTONS
4. MENU
5. AUDIO
6. DISPLAY
7. UP
8. LEFT
9. ENTER / BAND
10. PROGRAM
11. DOWN
12. F.REV

13. F.FWD
14. SLOW
15. RANDOM
16. ZOOM
17. SYSTEM
18. OPEN / CLOSE
19. SETUP
20. VOLUME +
21. VOLUME -
22. LOUD / EQ
23. PBC / AST
24. TITLE

25. SUBTITLE
26. PREVIOUS
27. RIGHT
28. NEXT
29. ANGLE
30. PLAY / PAUSE
31. STOP
32. A-B
33. REPEAT
34. PAL / NTSC
35. STEREO

1. [POWER/SOURCE]

Same functions as key on front panel.

2. [MUTE]

Same functions as key on front panel.

3. [NUMBERS 0~9]

For 1~6, press these buttons to store the current radio station or recall the stored station under the Radio Mode.

For 0~9, press these buttons to select the tracks, and input the code.

4. [MENU]

Press to return to the boot menu when playing DVD disc.

Press to select PBC on / off when playing VCD disc.

5. [AUDIO]

Press to select dialogue language when playing DVD disc.

Press to select left audio channel, right audio channel or stereo when playing VCD disc.

6. [DISPLAY]

Press to display current playback information when playing DVD disc.

7. [^] / 8. [<] / 11. [v] / 27. [>] Direction Key

Same functions as key on front panel.

9. [BAND/ENTER]

Same functions as key on front panel.

10. [PROGRAM]

Press to enter / exit the PROGRAM Function when playing the VCD, CD, MP3 disc.

12. [F.REW]

Press to select fast reverse with different speed.

13. [F.FWD]

Press to select fast forward with different speed.

14. [SLOW]

Press to activate slow motion playback. (DVD Mode only)

15. [RANDOM]

Press to turn RAMDOM function on / off when playing CD / VCD disc (PBC OFF).

16. [ZOOM]

Press to magnify the picture display when play DVD, VCD disc.

17. [SYSTEM]

Press to enter / exit the System Parameter Setup menu.

18. [OPEN/CLOSE]

Press to open / close the monitor.

19. [SETUP]

Press to enter the DVD SETUP menu.

20. [VOL+] / 21. [VOL-]

Press to increase / decrease the volume.

22. [LOUD/EQ]

Press to adjust the EQ setting as following:

USER – POP – CLASSIC – ROCK – JAZZ – USER

Hold on pressing to turn the LOUD function on / off.

23. [PBC/AST]

Press to turn the PBC function on / off when playing VCD disc.

Hold on pressing to seek radio station / TV channel automatically under RADIO / TV Modes.

24. [TITLE]

Press to enter the title menu when playing DVD disc.

25. [SUB-T]

Press to select the subtitle language when playing DVD disc.

26. [PREVIOUS]

Press to skip to play the pervious track.

28. [NEXT]

Press to skip to play the next track.

29. [ANGLE]

Press the [ANGLE] button during playback to select different viewing angles with interactive DVD media.

30. [PLAY/PAUSE]

Press to pause the playback when playing; press again to continue playing.

31. [STOP]

Press to stop the playback.

32. [A-B]

Press to setup A-B repeat playing.

33. [REPEAT]

Press to select the chapter / title / disc to repeat playing.

34. [P/N]

Press the button to switch the video output (PAL/NTSC) when playing DVD disc.

35. [STEREO]

Press to turn the stereo on / off under Radio Mode.

REPLACING THE BATTERIES

If the remote control has no function or if the operating range reduced, replace the old battery with new one.

1. Pull out the battery holder. Follow the arrow 1 slide it to the right toward the battery while at the same time pull the battery holder away from the remote control.

2. Place the new battery. Place the new lithium battery with the (+) side up.

3. Push the holder back. Using the finger to push in the holder back until the locking sound is heard.

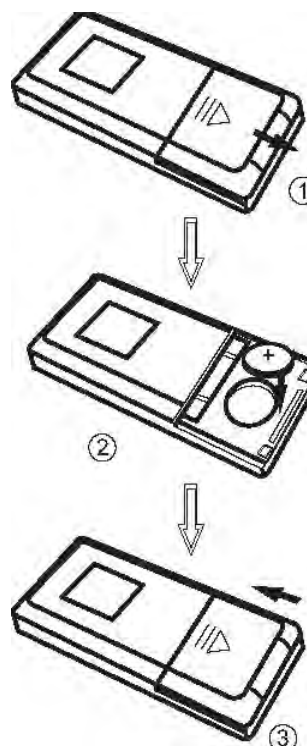

BASIC OPERATIONS

Startup

Press the [POWER/SOURCE] button on the panel or remote control to startup the power, the TFT monitor will spread out automatically and the system return to the working Mode when last turn off.

Turnoff

Hold on pressing the [POWER/SOURCE] button on the panel or remote control to turnoff the power, the TFT monitor will retract automatically.

NOTE

Close the ACC without turnoff, the unit will turn off automatically; and the TFT monitor will retract within 10 seconds automatically to protect the TFT monitor. Start the ACC again, the unit will startup and return to the last working Mode automatically, but the monitor does not spread out.

Working Mode

When the unit in turned ON, press the [POWER/SOURCE] button to toggle between the different modes as following:

RADIO – TV – IPOD – CDC – AV IN – GPS – DVD – USB – RADIO

NOTE

*The unit could be switched to DVD Mode if disc inside;
The unit could be switched to USB Mode if Mini USB connected;
The unit could be switched to IPOD Mode if iPod connected;
The unit could be switched to CDC Mode if CD/DVD changer connected;
The unit could be switched to GPS Mode if GPS connected;*

Detachable Front Panel

The front panel is detachable.

Taking out the front panel and the unit will turnoff automatically; and the TFT monitor will retract automatically.

NOTE

This function is burglarproof for unit security.

Telephone Mute Control

Connect the telephone mute control wire TEL_MUTE (see Wiring Diagram). If there is a vehicle call comes in, the sound volume will be automatically reduced to a very small value, and TFT monitor shows: YOU GET A PHONE; when call finished, the sound volume will recover to former volume, and the words YOU GET A PHONE disappear.

Auto Antenna Control

Connect the auto antenna control wire AUTO_ANT (see Wiring Diagram); the antenna will lift when the unit startup; it will descend when the unit turnoff.

Brake Control

It is necessary to connect the Brake Control wire to the Hand-brake switch of the car. While driving, the TFT monitor will display the alarm picture (see as follows) in order to ensure the safety.

Under the Rear View Mode, the Brake Control function is no effective.



Protection of the TFT Monitor

During the movement of the TFT monitor, if it is halted by force, then the unit will begin self-protection to prevent from any damage on the motorized mechanical structure. Press the [OPEN] button or shut down the ACC and then restart, the TFT monitor will act as the follow list to recover; if not, then please consult with an authorized service center.

Halt	Self-protection	Press the [OPEN] button	Shut down the ACC and restart
While extending	Retraction	Extending	Retraction
While retraction	Stop at the halt place and retract after 3 seconds	Extending	Retraction
While turning upward	Turning downward and retract ion	Extending	Turning downward and retract ion
While turning downward	Stop at the halt place	Turning downward and retract ion	Turning downward and retract ion

TOUCH SCREEN OPERATIONS

TOUCH SCREEN CALIBRATE

Under the RADIO Mode, press the button [SYSTEM] of panel or remote control to enter the CALIBRATE page:

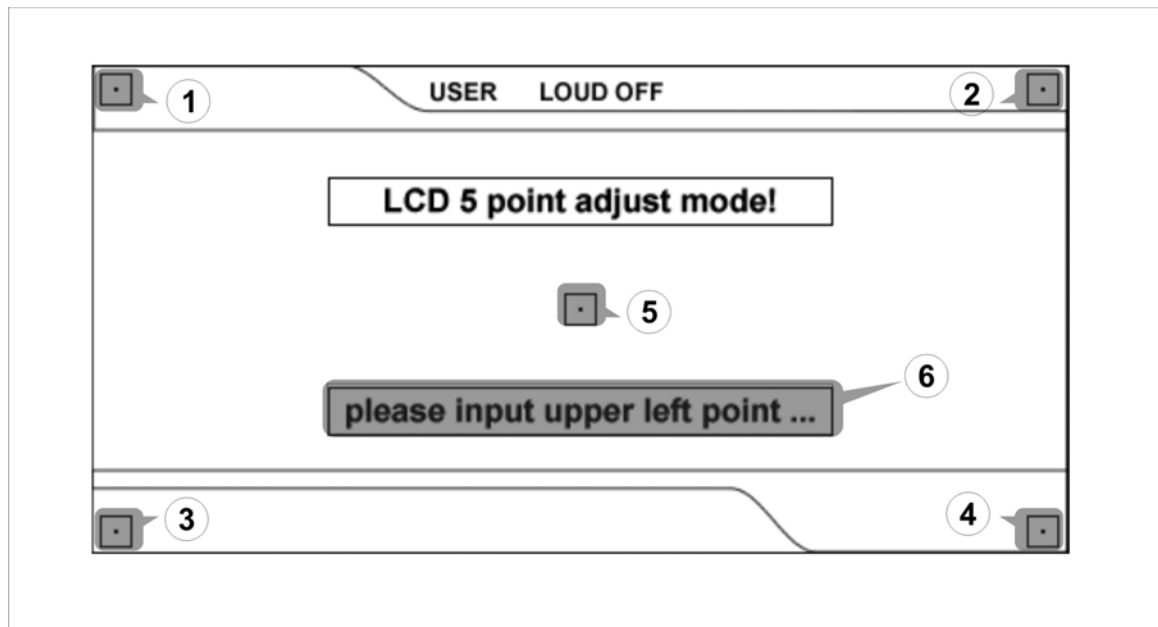

1 ~ 5: TOUCH POINTS

To touch the points from 1 to 5 by using a ballpoint pen or pencil, until all points are changed to red color.

6: INFORMATION

To guide the point that should be touched.

After all 5 points change to red color, press the [SYSTEM] button again to save the settings and finish the CALIBRATE procedure. Then the Touch Screen is restored to their default settings.

MAIN MENU

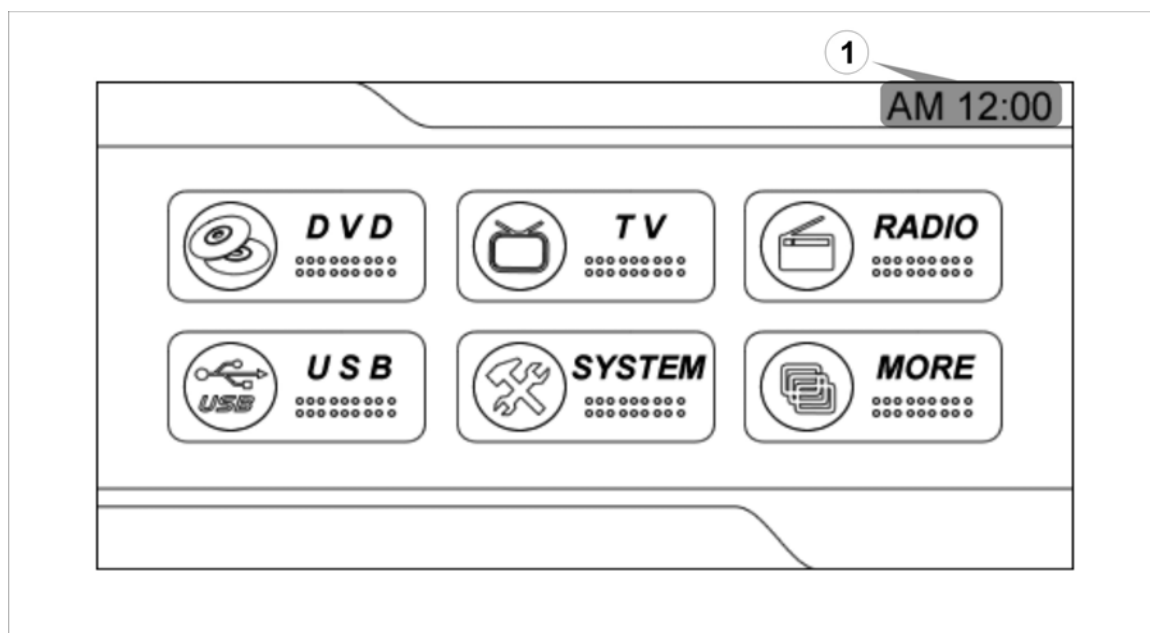

1, TIME

It is time display.

Touch the icon "MORE" to enter the 2nd page of main menu:

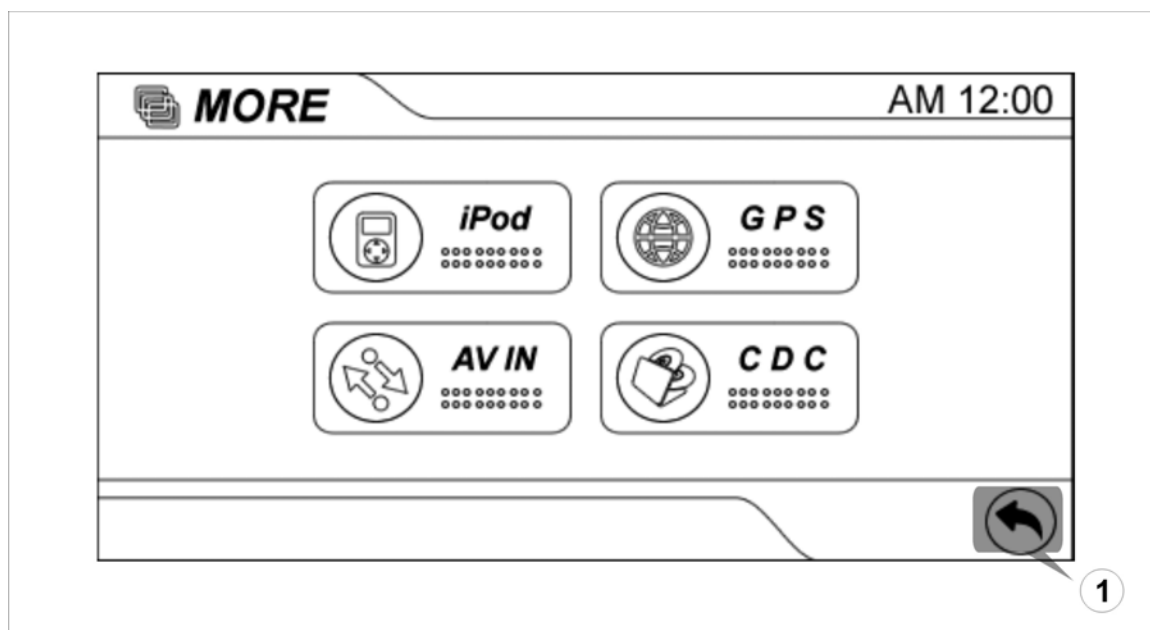

1, RETURN

Touch the icon "RETURN" to enter the 1st page of main menu.

RADIO OPERATIONS

Touch the icon “RADIO” to enter the **1st operation page of RADIO Mode:**

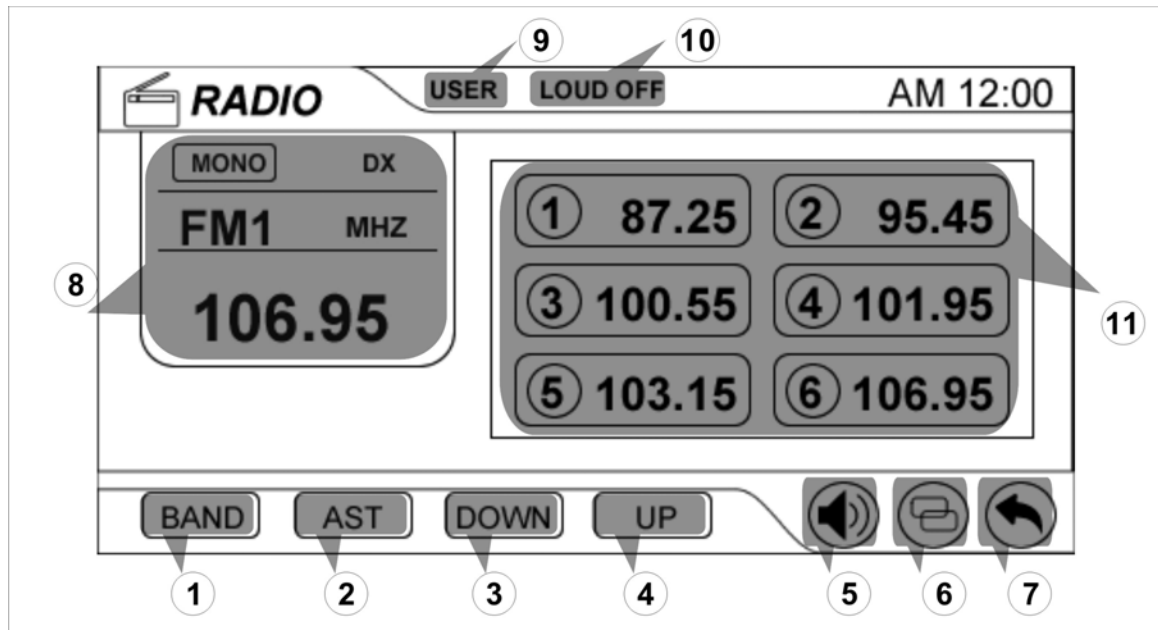

1, BAND

Touch the icon to switch the FM/AM wave band as following:

FM1 - FM2 - FM3 - AM1- AM2 - FM1

To press the [BAND/ENTER] button of panel or remote control performs same operation.

2, AST

Seeking and store the stations

1. Touch the icon to seek stations with the strongest signal from the lowest frequency point in the entire wave bands. Touch any icon or press any button to stop seeking. After seeking, the former stored stations will be instead.
2. Store the received effective radio frequency to the six stored channels M1~M6.
3. The unit will play the stations one by one for few seconds; touch any icon or press any button to stop playing.
4. It is independent for FM & AM frequency. There are 3 wave bands of FM1、FM2、FM3 & 2 wave bands of AM1、AM2, each can store 6 radio stations, totally 30 radio stations.
5. The unit will stop on the beginning frequency if no available station after seeking one cycle.

To hold on pressing the [PBC/AST] button of remote control performs same operation.

3, DOWN / 4, UP

Touch the icons to adjust the frequency downward / upward by step decreasing / increasing.

To press the [V] / [^] buttons of the remote control performs same operation.

5, MUTE

Touch the icon to switch off the sound; touch it again to resume to the previous volume level.

6, NEXT PAGE

Touch the icon to enter the 2nd operation page of RADIO Mode.

7, RETURN

Touch the icon to enter the 1st page of main menu.

8, RADIO INFORMATION

This is the current radio information display including band, frequency, stereo and local etc.

9, EQ INFORMATION

This is the current EQ settings information display.

Press the [EQ] button to switch the EQ settings as following:

10, LOUD INFORMATION

This is the current LOUD settings information display.

Press the [EQ] button to switch the EQ settings as following:

11. STORED CHANNEL

Manual Store Radio Station

Hold on touching the icon, you can store current radio frequency to the stored channel.

For example, the current frequency is 98.5MHZ, by hold on touching the icon channel 1; you can store the radio station of 98.5MHZ to the channel 1.

After manual store radio station, the former stored stations will be instead.

In each wave band, the number icon channels 1 to 6 represent the stored radio stations.

To hold on pressing the number buttons 1~6 on remote control performs same operation.

Recall a Preset Station

Touch the icon channel 1~6 to recall the corresponding stored station in M1~M6 channels.

To press the number buttons 1~6 on remote control perform same operation.

2nd Operation Page of RADIO Mode:

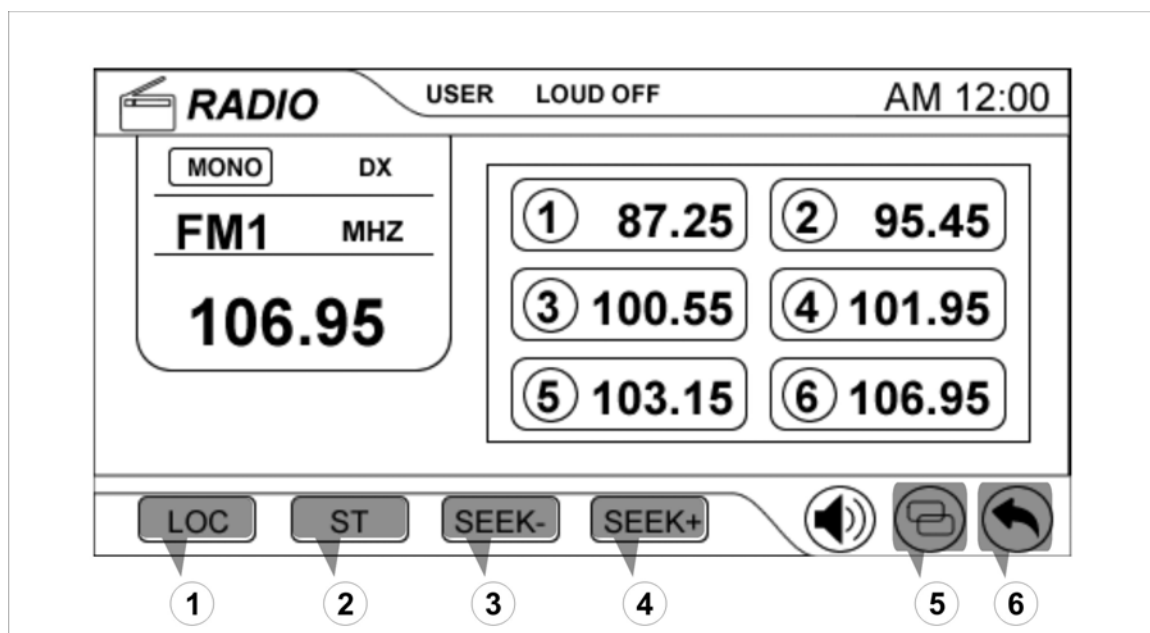

1, LOCAL

Touch the icon to set the ON / OFF

When you are using the local searching function of LOCAL, you can only receive the radio station with strong enough signals and fine state.

2, STEREO

Touch the icon to turn the stereo on / off under Radio Mode.

3. SEEK - / 4. SEEK +

Touch the icon to seek the next available channel by increasing / decreasing the tuning frequency.

Press any button to stop seeking.

Seeking will stop automatically when seek an available channel then play this station.

The unit will stop on the beginning frequency if no available station after seeking one cycle.

To hold on pressing [>] / [<] buttons of panel or remote control performs same operation.

5, NEXT PAGE

Touch the icon to enter the 1st operation page of RADIO Mode.

6, RETURN

Touch the icon to enter the 1st page of main menu.

DVD OPERATIONS

Touch the icon “DVD” to enter the DVD Mode if disc inside.

The unit will switch to DVD Mode automatically if loading disc.

The unit will switch to RADIO Mode automatically if ejecting disc.

1st operation page of DVD Mode:

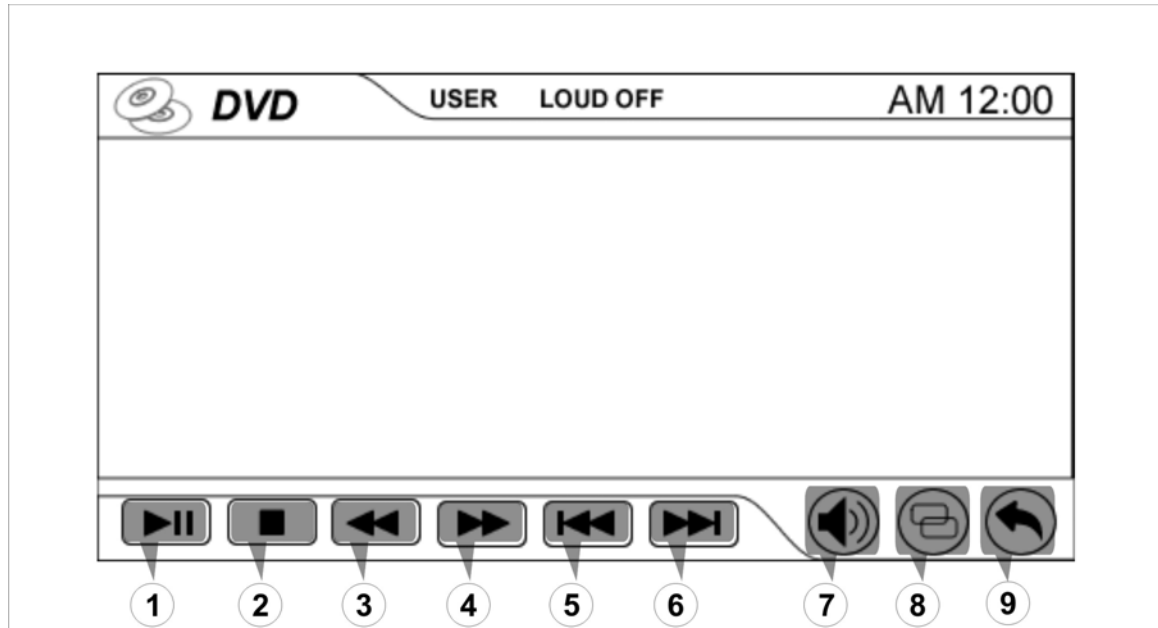

1. PLAY / PAUSE

Touch the icon to play or pause the disc.

To press the [PLAY/PAUSE] button of panel or remote control performs the same operation.

2. STOP

During movie playback, touch the icon once; the DVD player memorizes the location where you stopped (touch the [PLAY] icon to resume playing from the memorized location). If you touch the icon twice, the playback will start from the beginning of the disc when you touch the [PLAY] icon.

To press the [STOP] button of remote control performs the same operation.

3. F.REV / 4. F.FWD

Touch the icon to select fast reverse / forward search.

Touch the [PLAY] icon to resume to normal playback.

To press the [F.REV] / [F.FWD] buttons of remote control performs the same operation.

5. PREV / 6. NEXT

Touch the icon to go to the pervious / next chapter, track or song.

To press the [Previous] / [Next] buttons of remote control performs the same operation.

7, MUTE

Touch the icon to switch off the sound; touch it again to resume to the previous volume level.

8, NEXT PAGE

Touch the icon to enter the 2nd operation page of DVD Mode.

9, RETURN

Touch the icon to enter the 1st page of main menu.

2nd operation page of DVD Mode:

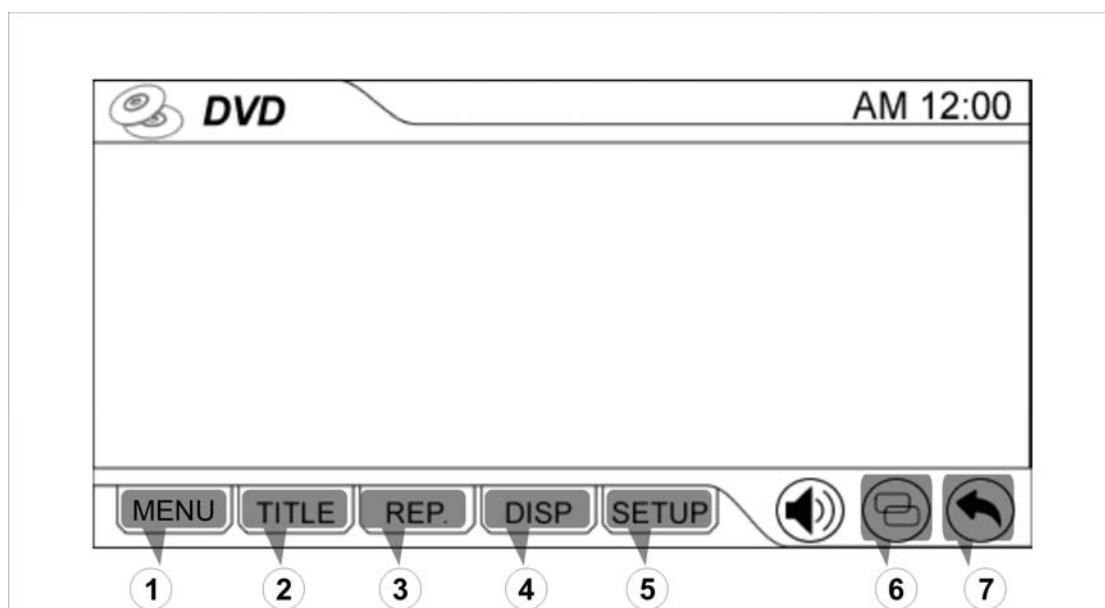

1, MENU

Touch the icon to return to the boot menu when playing DVD disc.

Touch the icon to select PBC on / off when playing VCD disc.

2, TITLE

Touch the icon to enter the title menu when playing DVD disc.

3, REPEAT

Touch the icon to select the chapter / title / disc to repeat playing.

4, DISPLAY

Touch the icon to display current playback information when playing DVD disc.

5, SETUP

Touch the icon to enter the DVD SETUP menu.

6, NEXT PAGE

Touch the icon to enter the 1st operation page of DVD Mode.

7, RETURN

Touch the icon to enter the 1st page of main menu.

USB OPERATIONS

Touch the icon “USB” to enter the USB Mode if USB connected.

The unit will switch to USB Mode automatically if connecting USB.

When disconnecting USB, the unit will switch to RADIO Mode automatically if there is no disc in the unit; and the unit will switch to DVD Mode automatically if there is a disc inside.

Under USB Mode, all operations are same as DVD operations.

TV OPERATIONS

Touch the icon “TV” to enter the TV Mode:

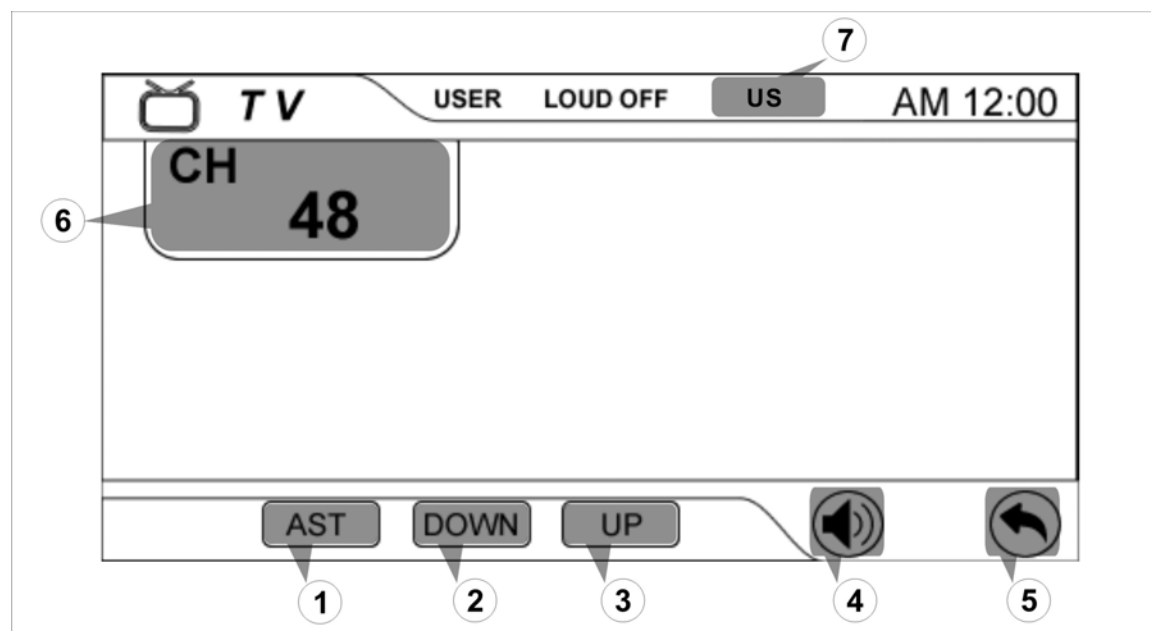

1, AST

Touch the icon to seek all stations with the strongest signal from the lowest frequency point; press any button to stop seeking. The unit will stop on the beginning frequency if no available station after seeking one cycle.

To press the [PBC/AST] button of remote control performs same operation.

2. DOWN / 3. UP

1. After AST seeking, touch the icon to select the stations downward / upward.

To press the [^] / [v] buttons of remote control performs same operation.

2. Hold on touching the icon to seek the next available channel by increasing / decreasing the tuning frequency; touch any icon to stop seeking. Seeking will stop automatically when seek an available channel then play this station. The unit will stop on the beginning frequency if no available station after seeking one cycle.

To hold on pressing [>] / [<] buttons of panel or remote control performs same operation.

4, MUTE

Touch the icon to switch off the sound; touch it again to resume to the previous volume level.

5, RETURN

Touch the icon to enter the 1st page of main menu.

6, TV CHANNEL INFORMATION

7, TV AREA & AUDIO FORMAT INFORMATION

IPOD OPERATIONS

Touch the icon "IPOD" to enter the IPOD Mode if iPod connected.

The unit will switch to IPOD Mode automatically if connecting iPod.

The unit will switch to RADIO Mode automatically if disconnecting iPod.

NOTE:

It is available for iPod operations with an additional iPod cable which is optional accessory.

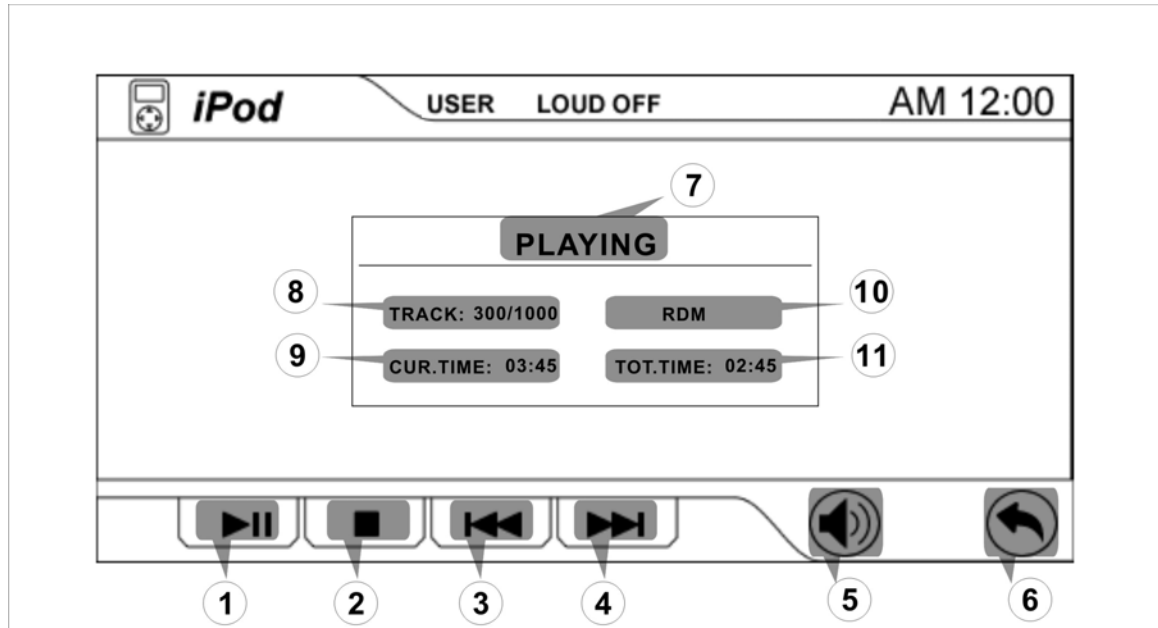

1. PLAY / PAUSE

Touch the icon to play or pause the track.

To press the [PLAY/PAUSE] button of panel or remote control performs the same operation.

2. STOP

1, During playback, touch the icon once; the unit memorizes the location where you stopped (touch the [PLAY] icon to resume playing from the memorized location). If you touch the icon twice, the playback will start from the beginning of the disc when you touch the [PLAY] icon.

To press the [STOP] button of remote control performs the same operation.

2, Hold on touching the icon, switch the operation control to iPod itself. To use the controller of iPod itself to control all operations of iPod including play music, videos and view pictures.

**Ipod Have Disconnect Now,
To Watch Video,uses Your Ipod
Control Funtions, Press STOP
Key By Long Pressing, Return
Music Mode.**

Hold on touching the [STOP] button again to switch to play the music of iPod.
To hold on pressing the [STOP] button of remote control performs same operation.

NOTE:

Under the Music Mode of iPod, it is not effective for the controller of iPod itself, use the keys of unit to control the operation and all operations are same as DVD Mode.

3. PREV / 4. NEXT

Touch the icon to go to the pervious / next chapter, track or song.
To press the [PREVIOUS] / [NEXT] buttons of remote control performs same operation.

5, MUTE

Touch the icon to switch off the sound; touch it again to resume to the previous volume level.

6, RETURN

Touch the icon to enter the 2nd page of main menu.

7, STATUS of PLAYBACK

PLAYING or PAUSE.

8, THE NUMBER of PLAYING SONG / THE TOTAL SONGS in PLAY LIST

9, THE PLAYING TIME

10, INFORMATION of PLAYBACK

This is for RANDOM, REPEAT of playback.

11, THE TOTAL PLAYBACK TIME

NOTE:

The TV Output in iPod SETUP should be effective, and the pictures & videos could be displayed on the TFT monitor of unit.

AV IN OPERATIONS

Touch the icon “AV IN” to enter the AV IN Mode:

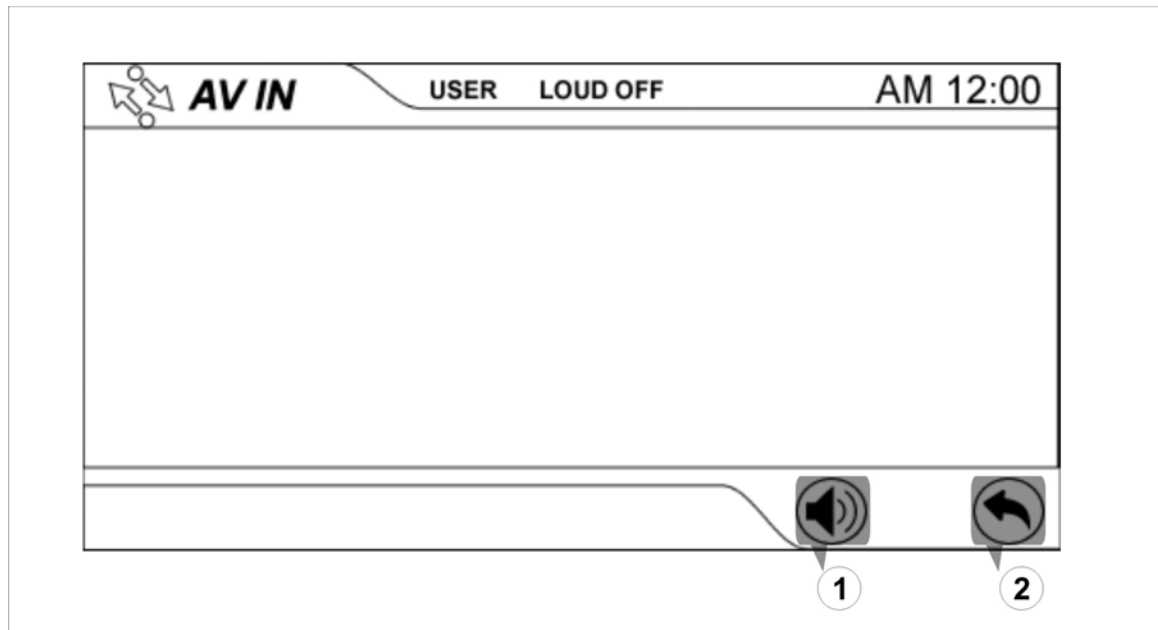

1, MUTE

Touch the icon to switch off the sound; touch it again to resume to the previous volume level.

2, RETURN

Touch the icon to enter the 2nd page of main menu.

NOTE:

1, when rear gear is engaged, the monitor will extend automatically to display the picture taken by the rear camera if monitor closed.

2, There are 2 RCA Audio Inputs & 1 RCA Video Input for unit.

CDC OPERATIONS

Touch the icon “CDC” to enter the CDC Mode if CD/DVD changer connected:

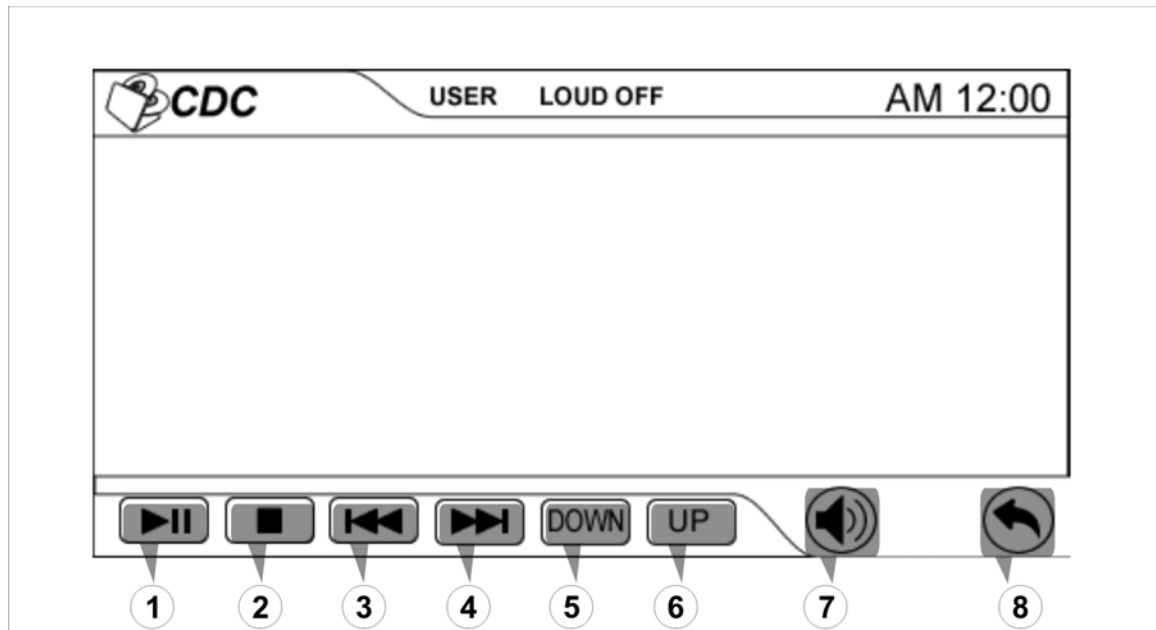

1. PLAY / PAUSE

Touch the icon to play or pause the disc.

To press the [PLAY/PAUSE] button of panel or remote control performs the same operation.

2. STOP

During movie playback, touch the icon once; the DVD player memorizes the location where you stopped (touch the [PLAY] icon to resume playing from the memorized location). If you touch the icon twice, the playback will start from the beginning of the disc when you touch the [PLAY] icon.

To press the [STOP] button of remote control performs the same operation.

3. PREV / 4. NEXT

Touch the icon to go to the previous / next chapter, track or song.

To press the [PREVIOUS] / [NEXT] buttons of remote control performs same operation.

5. DISC-DOWN / 6. DISK-UP

Touch the icon to change the next / previous disc to play.

7, MUTE

Touch the icon to switch off the sound; touch it again to resume to the previous volume level.

8, RETURN

Touch the icon to enter the 2nd page of main menu.

GPS OPERATIONS

Touch the icon "GPS" to enter the GPS Mode:

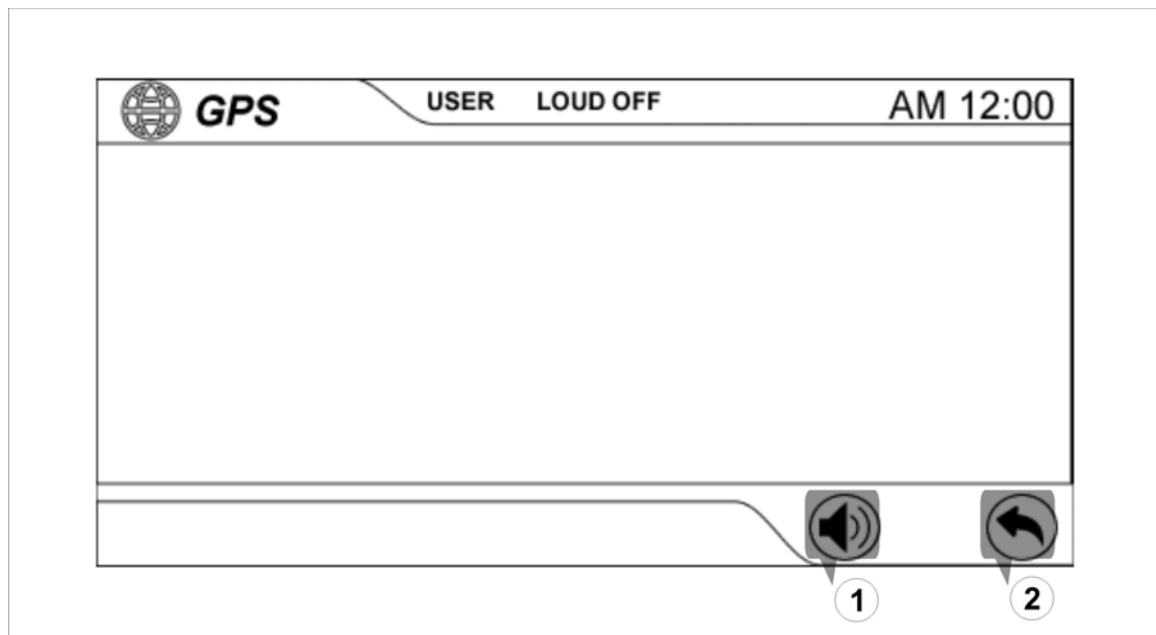

1, MUTE

Touch the icon to switch off the sound; touch it again to resume to the previous volume level.

2, RETURN

Touch the icon to enter the 2nd page of main menu.

SYSTEM SETUP

Touch the icon “SYSTEM” or hold on pressing the [VOL / SEL] button of panel to enter the SETUP of system parameters:

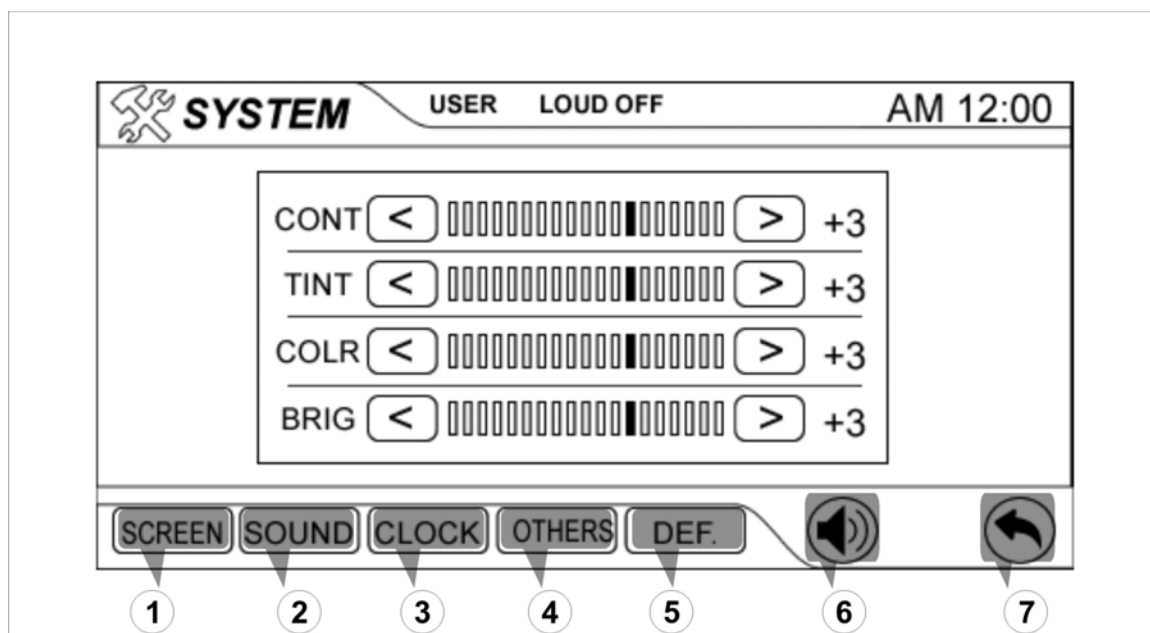

1. SCREEN PARAMETER SETUP

2. SOUND PARAMETER SETUP

3. CLOCK SETUP

4. OTHER PARAMETER SETUP

Touch the icon 1~4 to select the main menus directly.

5. DEFAULT SETTINGS

Touch the icon to restore the default settings.

6, MUTE

Touch the icon to switch off the sound; touch it again to resume to the previous volume level.

7, RETURN

Touch the icon to enter the 1st page of main menu.

SCREEN PARAMETER SETUP

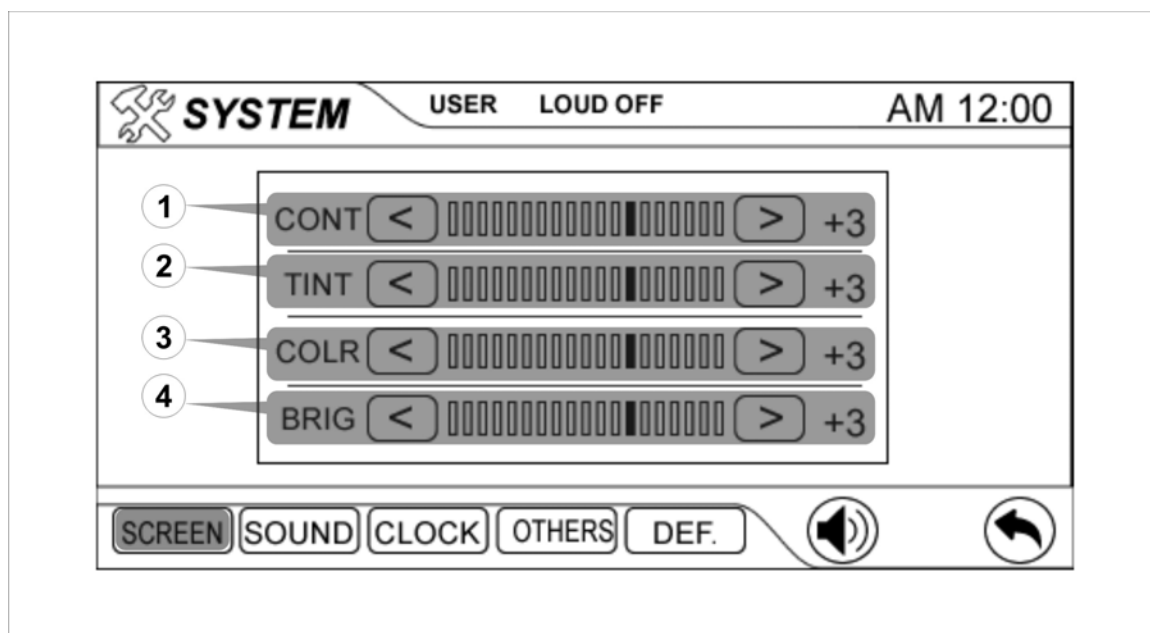

- 1, CONTRAST: -9 ~ +9
- 2, TINT: -9 ~ +9
- 3, COLOR: -9 ~ +9
- 4, BRIGHTNESS: -9 ~ +9

SOUND PARAMETER SETUP

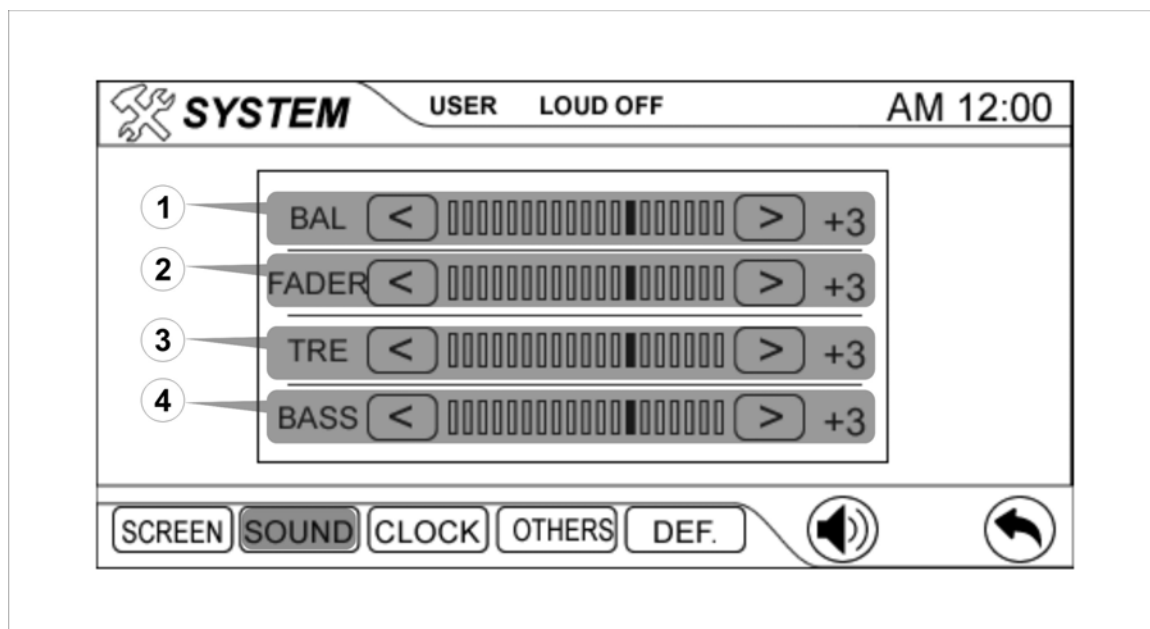

- 1, BALANCE: -9 ~ +9
- 2, FADER: -9 ~ +9
- 3, TREBLE: -9 ~ +9
- 4, BASS: -9 ~ +9

CLOCK SETUP

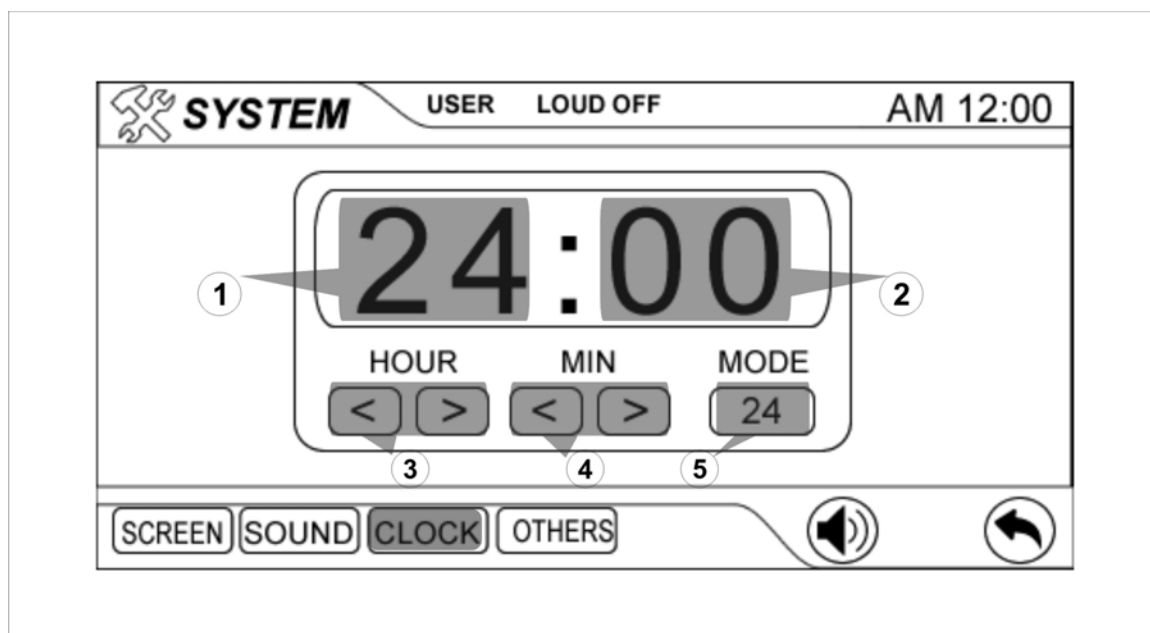

- 1, TIME DISPLAY: This is the time display.
- 2, HOUR: 00 ~ 23
- 2, MINUTE: 00 ~ 59
- 4, CLOCK MODE: 12H / 24H

OTHER PARAMETER SETUP

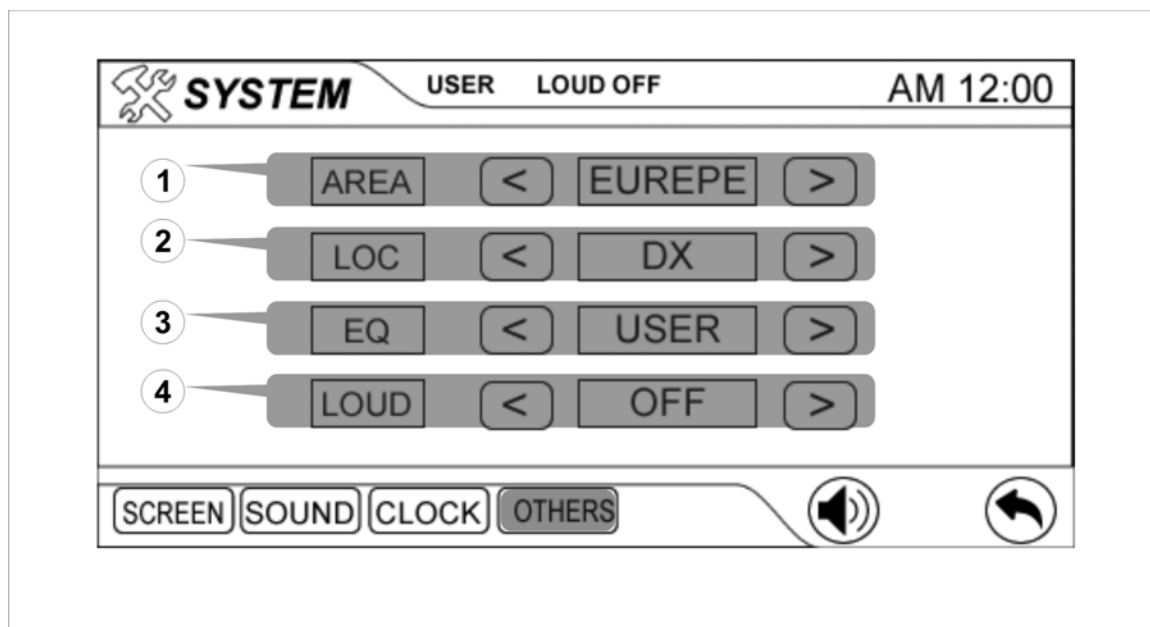

- 1, RADIO AREA: EUROPE – ASIA – USA – JAPAN – OIRT – EUROPE
- 2, LOCAL: LOCAL – DX
- 3, EQ: USER – POP – CLASSIC – ROCK – JAZZ – USER
- 4, LOUD: ON / OFF

DVD SETUP MUNE

SETUP MENU OPERATION

Press the [SETUP] button of remote control to enter the DVD SETUP Menu.

Press the [<] / [>] buttons to switch the main menus as following:

SYSTEM – LANGUAGE – AUDIO – VIDEO – SPEAKER – DIGITAL

Press the [^] / [v] buttons to enter the submenus from main menus.

Press the [^] button on the top submenu or press the [v] button on the bottom of submenu to exit the submenus to main menus.

Press the [^] / [v] buttons to select the submenus as your need.

Press the [>] or [ENTER] buttons to enter the items of submenus.

Press the [<] button to exit the items of submenus.

Press the [v] / [^] buttons to select the item you want to change.

Press the [ENTER] button to confirm the item you have selected and exit to the submenus.

Press the [SETUP] button of remote control or press the [ENTER] button on the submenu EXIT SETUP to exit the DVD SETUP Menu and save all settings.

NOTE

Effective only DVD, SD & USB Mode.

SYSTEM SETUP

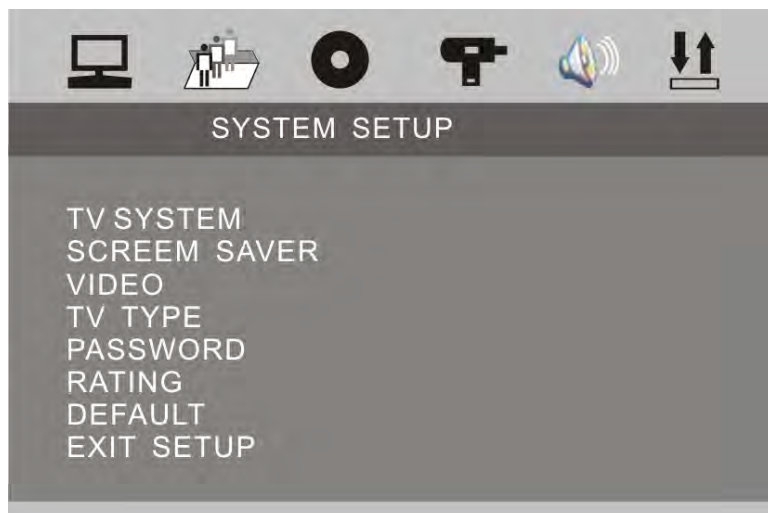

TV SYSTEM

Following options are available for the TV Display:

NTSC PAL 60 PAL AUTO

SCREEN SAVER

Select ON or OFF.

VIDEO

Following options are available for the TV Display:

INTERLACE-YUV TV-RGB P-SCAN YPBPR S-VIDEO

TV TYPE

Following options are available for the TV Display:

4 : 3 PS 4 : 3 LB 16 : 9

PASSWORD

Setup the password for Parental Ratings change. The default password is 0000.

RATING

Following options are available for the Parental Ratings:

1 KID SAFE 2 G 3 PG 4 PG 13
5 PG - R 6 R 7 NC - 17 8 ADULT

The Parental Ratings could be changed after the correct password input.

DEFAULT

The unit will restore all default settings by selecting this option.

LANGUAGE SETUP



OSD LANGUAGE

Following options are available for the OSD LANGUAGE:

ENGLISH	GERMAN	SPANISH	FRENCH	PORTUGUESE
ITALIAN	RUSSIAN	DUTCH	SWEDISH	KOREAN
DANISH	NORWEGIAN	POLISH	HUNGARIAN	

AUDIO LANGUAGE

Following options are available for the AUDIO LANGUAGE:

ENGLISH	GERMAN	SPANISH	FRENCH	PORTUGUESE
ITALIAN	RUSSIAN	DUTCH	SWEDISH	KOREAN
DANISH	NORWEGIAN	POLISH	HUNGARIAN	

SUBTITLE LANGUAGE

Following options are available for the SUBTITLE LANGUAGE:

ENGLISH	GERMAN	SPANISH	FRENCH	PORTUGUESE
ITALIAN	RUSSIAN	DUTCH	SWEDISH	KOREAN
DANISH	NORWEGIAN	POLISH	HUNGARIAN	

MENU LANGUAGE

Following options are available for the MENU LANGUAGE:

ENGLISH	GERMAN	SPANISH	FRENCH	PORTUGUESE
ITALIAN	RUSSIAN	DUTCH	SWEDISH	KOREAN
DANISH	NORWEGIAN	POLISH	HUNGARIAN	

DIVX LANGUAGE

Following options are available for the DIVX LANGUAGE:

CENTRAL	EU
WESTERN	EU
KOREAN	

AUDIO SETUP



AUDIO OUT

Following options are available for the AUDIO OUT:

SPDIF / OFF SPDIF / RAW SPDIF / PCM

KEY

Following options are available for the KEY:

b -4 -2 0 +2 +4 #

VIDEO SETUP

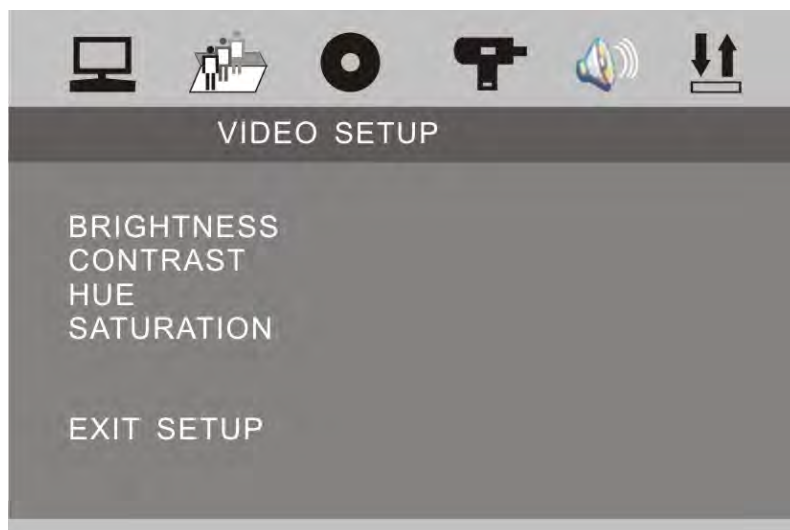

BRIGHTNESS

Following options are available for the BRIGHTNESS:

0 2 4 6 8 10 12

CONTRAST

Following options are available for the CONTRAST:

0 2 4 6 8 10 12

HUE

Following options are available for the HUE:

-6 -4 -2 0 +2 +4 +6

SATURATION

Following options are available for the SATURATION:

0 2 4 6 8 10 12

SPEAKER SETUP



DOWNMIX

Following options are available for the DOWNMIX:

LT / RT Stereo VSS

BASS MODE

Following options are available for the BASS MODE:

ALL LG SPK ALL SM SPK MIXED SPK

DIGITAL SETUP

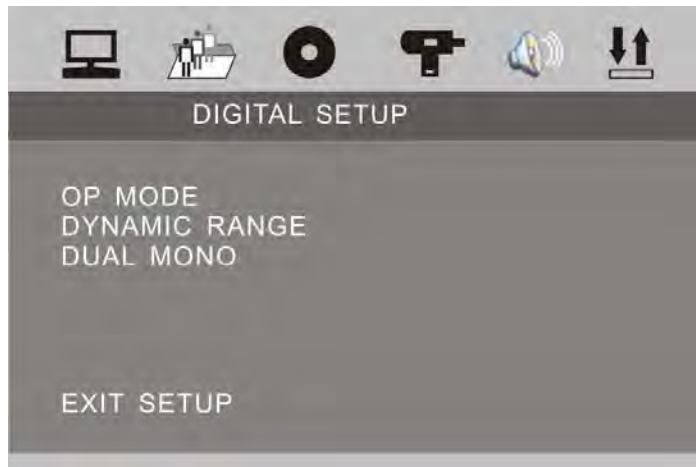

OP MODE

Following options are available for the OP MODE:

LINE OUT RF REMOD

DYNAMIC RANGE

Following options are available for the DYNAMIC RANGE:

FULL 6 / 8 4 / 8 2 / 8 OFF

DUAL MONO

Following options are available for the DUAL MONO:

STEREO MONO L MONO R MIX MONO

TROUBLE SHOOTING

If any of problem persists after checking the below list, Please consult your nearest service dealer.

Never attempt to disassemble and repair unit personally.

Problem	Cause	Corrective Action
GENERAL		
Unit will not power on	ACC Fuse blown Car battery fuse blown illegal operation	Install new fuse with correct rating Install new fuse with correct rating Press the RESET button located in the bottom right corner of the front panel
Remote control does not	Battery depleted Battery installed incorrectly	Replace battery with new one Remove battery and install correctly
No/low audio output	Improper audio output connection Volume set too low Speakers damaged Heavily biased volume balance Speakers wiring is in contact with metal Part or car	Check wiring and correct Increase volume level Review wiring diagram and check MUTE connection Replace speakers Adjust the channel balance to the center position Insulate all speaker wiring connections
Poor sound quality or distortion	Pirate disc is in use Speaker power rating not compatible with unit Speaker is shorted	Use original copy Connect proper speakers Check speaker contact
Tel-Mute malfunction	"MUTE " wire is grounded	Check that MUTE connection is not grounded and that it's properly insulated
Unit resets itself when engine is off	Incorrect connection between ACC and Positive battery wire	Check wiring and correct
TUNER		
Weak station searching	Auto antenna is not fully extended Auto antenna not properly connected LOCAL function is activated	Connect the auto antenna control cable properly Connect the auto antenna control cable properly Turn LOCAL function off

Problem	Cause	Corrective Action
TFT MONITOR		
Monitor does not open automatically	TFT Auto Open is turned of	Turn TFT Auto open on
No image	Incorrect connection to parking brake wire PARKING is activated and parking brake is not engaged	Check wiring and correct Stop vehicle in safe place and apply parking brake
Flashing image or interference appears on screen	DVD is not compatible with current TV system settings Image blurred, distorted, or dark	Change setup to accommodate disc
Prolonged image or improper height/width ratio display	Improper video signal connections Improper aspect ratio setup	Check wiring and correct Use correct aspect ratio setting
Monitor stops at incorrect position	Moving path is blocked	Press OPEN key to restart monitor movement
VCD		
Cannot insert disc	Disc already inside unit	Eject current disc and insert new one
Disc does not play back	Disc is warped or scratched Disc is dirty or wet Incompatible disc is used Disc rating exceeds Parental Lock rating limit Disc region code is not compatible with unit Disc is inserted upside down	Use disc in good condition Clean disc with soft cloth Use compatible disc Change parental Lock settings to lower restriction Use compatible disc Change Parental Lock settings to lower restriction Use disc with proper region cod Insert disc with label side up
Image blurred , distorted, or dark	Disc is illegally copied	Use original disc
PBC cannot be used during VCD playback	PBC is not available on the disc	
No repeat or searching while playing VCD	PBC is on	Turn PBC off

Problem	Cause	Corrective Action
MP3		
Interruption occurred during playback	Disc is dirty or scratched	Clean disc or replace
	File is damaged/bad recording	Recreate disc with good files
Incorrect playback message displayed	Message is longer than LCD can display	

Error Messages

Message Displayed	Cause	Corrective Action
Loading	Disc is being read	
No disc	Disc is dirty	Clean disc with soft cloth
	Disc is upside down	Insert disc with label side up
	Disc not present in loading compartment	Insert disc
Bad Disc	Disc is dirty	Clean disc with soft cloth
	Disc is upside down	Insert disc with label side up
Unknown disc	Disc format is not compatible with this unit	
Region Error	DVD is not compatible with region code of unit	
Error	illegal mechanism operation	Press EJECT key for 5 seconds to reset loading mechanism

SPECIFICATIONS

GENERAL

Supply Voltage	: 14.4 V DC (10.8-16 V DC Allowable)
Load Impedance	: 4 Ω
Max Power Output	: 50 W x 4
Tone Controls	: ± 18 dB
Bass 100Hz	: ≥ 10 dB
Treble 10KHz	: ≥ 10 dB
Dimension (approx)	: 187 x 188 x 60 mm (d/w/h)
Mounting (approx)	: 160 x 178 x 50 mm (d/w/h)

FM TUNER

Frequency Range	: 87.5-107.9 MHz (USA) : 87.5-108.0 MHz (Europe/China)
IF	: 10.7 MHz
Usable Sensitivity	: ≤ 15 dB μ V
Stereo Separation	: ≥ 27 dB(1KHz)
Frequency Response	: 20-10000 Hz

AM TUNER

Frequency Range	: 522-1620 KHz (Europe) : 531-1602 KHz (China) : 530-1710 KHz (USA)
IF	: 450 KHz
Usable Sensitivity	: ≤ 34 dB μ V

TV TUNER

Frequency Range	PAL: 48.25MHz - 855.25MHz NTSC: 55.25MHz - 855.25MHz
-----------------	---

DVD PLAYER

Signal System	: PAL/NTSC
Signal-to-noise Ratio	: ≥ 80 dB(1KHz)
Distortion	: $\leq 0.5\%$

MONITOR

Resolution	: 1440 (w) x 234 (H) (RGB)
Brightness	: 400 cd/m ²
Contrast	: 300:1

NOTE:

Specifications and design are subject to modification without notice due to improvements in technology.

DISC NOTES

- Disc formats supported by this player



Handling and Cleaning

- Dirty, dusty, scratched or warped discs will cause misoperation.
- Do not place stickers or make scratches on discs.
- Do not warp discs.
- A disc should always be kept in its case when not in use to prevent from damage.
- Do not place discs in the following places:
 1. Direct sunlight.
 2. Dirty, dusty and damp areas.
 3. High temperature places.
 4. On the seats or dashboard.

Disc Cleaning

Use a dry soft cloth to wipe the surface. If the disc is quite dirty, use a soft cloth slightly moist with isopropyl (rubbing) alcohol. Never use solvent such as benzene, thinner or conventional record cleaners which may mar the surface of the disc.

Notes:

A disc may become somewhat scratched (although not enough to make it unusable) depending on your handling in the condition of the usage environment. These scratches are not an indication of any problem with the player.

Repairing New Discs with Rough Spots

A new disc may have rough edges on its inside and outside edges. If a disc with rough edges is used, the proper setting will not be performed and the player will not play the disc. Therefore, remove the rough edges in advance by using a ballpoint pen or pencil. To remove the rough edges, press the side of the pen or pencil against the inside and outside edges of the disc.

