

# JVC



## CD/SD RECEIVER

## KD-AR960/KD-LH910

## RECEPTOR CON CD/SD

## KD-AR960/KD-LH910

## RECEPTEUR CD/SD

## KD-AR960/KD-LH910

ENGLISH

ESPAÑOL

FRANÇAIS

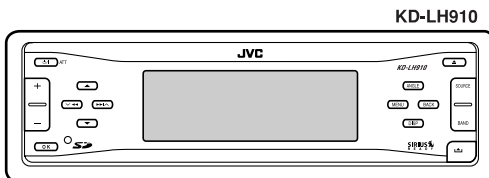
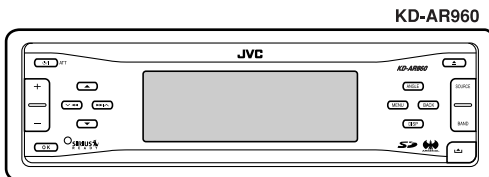
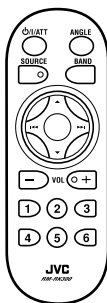
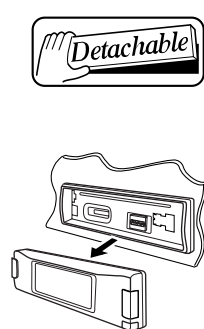

For canceling the display demonstration, see page 9.  
Para cancelar la demostración en pantalla, consulte la página 9.  
Pour annuler la démonstration des affichages, référez-vous à la page 9.

For installation and connections, refer to the separate manual.  
Para la instalación y las conexiones, refiérase al manual separado.  
Pour l'installation et les raccordements, se référer au manuel séparé.

**For customer Use:**  
Enter below the Model No. and Serial No. which are located on the top or bottom of the cabinet.  
Retain this information for future reference.

Model No. \_\_\_\_\_  
Serial No. \_\_\_\_\_

# INSTRUCTIONS

## MANUAL DE INSTRUCCIONES

## MANUEL D'INSTRUCTIONS

Thank you for purchasing a JVC product.

Please read all instructions carefully before operation, to ensure your complete understanding and to obtain the best possible performance from the unit.

### **INFORMATION (For U.S.A.)**

This equipment has been tested and found to comply with the limits for a Class B digital device, pursuant to Part 15 of the FCC Rules. These limits are designed to provide reasonable protection against harmful interference in a residential installation. This equipment generates, uses, and can radiate radio frequency energy and, if not installed and used in accordance with the instructions, may cause harmful interference to radio communications. However, there is no guarantee that interference will not occur in a particular installation. If this equipment does cause harmful interference to radio or television reception, which can be determined by turning the equipment off and on, the user is encouraged to try to correct the interference by one or more of the following measures:

- Reorient or relocate the receiving antenna.
- Increase the separation between the equipment and receiver.
- Connect the equipment into an outlet on a circuit different from that to which the receiver is connected.
- Consult the dealer or an experienced radio/TV technician for help.

### **IMPORTANT FOR LASER PRODUCTS**

1. CLASS 1 LASER PRODUCT
2. **CAUTION:** Do not open the top cover. There are no user serviceable parts inside the unit; leave all servicing to qualified service personnel.
3. **CAUTION:** Visible and invisible laser radiation when open and interlock failed or defeated. Avoid direct exposure to beam.

#### **Warning:**

If you need to operate the receiver while driving, be sure to look ahead carefully or you may be involved in a traffic accident.

#### **Cautions:**

If the temperature inside the car is below 0°C (32°F), the movement of animation and text scroll will be halted on the display to prevent the display from being blurred.

**LOWTEMP** appears on the display.

When the temperature increases, and the operating temperature is resumed, these functions will start working again.

#### **How to reset your unit**

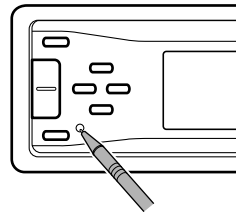

*This will reset the microcomputer. Your preset adjustments will also be erased.*

# Contents

How to reset your unit .....	2	<b>Graphic displays .....</b>	<b>25</b>
How to read this manual.....	4	<b>Basic procedure .....</b>	<b>25</b>
How to forcibly eject a disc.....	4	Downloading the files.....	26
How to change the display pattern .....	5	Deleting the files.....	27
How to enter the various menus .....	5	Activating the downloaded files .....	29
<b>Control panel —</b>		<b>General settings — PSM .....</b>	<b>30</b>
<b>KD-AR960/KD-LH910.....</b>	<b>6</b>	Basic procedure .....	30
Parts identification.....	6	Selecting the dimmer mode .....	34
<b>Remote controller —</b>		Changing the display color .....	35
<b>RM-RK300 .....</b>	<b>7</b>	<b>Other main functions .....</b>	<b>37</b>
Main elements and features .....	7	Assigning titles to the sources .....	37
<b>Getting started.....</b>	<b>8</b>	Changing the control panel angle .....	38
<b>Basic operations.....</b>	<b>8</b>	Detaching the control panel.....	38
Canceling the display demonstrations ...	9	<b>External component operations... 39</b>	
Setting the clock .....	9	<b>Playing an external component .....</b>	<b>39</b>
<b>Radio operations .....</b>	<b>10</b>	<b>SIRIUS® radio operations .....</b>	<b>40</b>
<b>Listening to the radio.....</b>	<b>10</b>	<b>Listening to the SIRIUS® radio.....</b>	<b>41</b>
Storing stations in memory.....	11	Storing channels in memory.....	42
Listening to a preset station .....	12	Listening to a user channel .....	42
<b>Disc/SD card operations.....</b>	<b>13</b>	Selecting a category/channel on the list.....	43
<b>Playing a disc in the receiver .....</b>	<b>13</b>	<b>Maintenance .....</b>	<b>45</b>
<b>Playing discs in the CD changer .....</b>	<b>14</b>	<b>More about this receiver .....</b>	<b>46</b>
<b>Playing an SD card .....</b>	<b>15</b>	<b>Troubleshooting .....</b>	<b>49</b>
Other main functions .....	17	<b>Specifications .....</b>	<b>53</b>
Selecting the playback modes.....	19		
<b>Sound adjustments .....</b>	<b>21</b>		
<b>Setting the basic sound selection         menu — SEL .....</b>	<b>21</b>		
Selecting preset sound modes (i-EQ: intelligent equalizer).....	23		
Storing your own sound modes .....	23		

## \*For safety....

- Do not raise the volume level too much, as this will block outside sounds, making driving dangerous.
- Stop the car before performing any complicated operations.



## \*Temperature inside the car....

If you have parked the car for a long time in hot or cold weather, wait until the temperature in the car becomes normal before operating the unit.

## How to read this manual

The following methods are used to make the explanations simple and easy-to-understand:

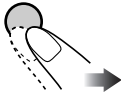
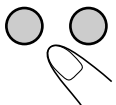
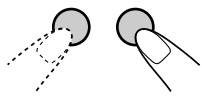
- Some related tips and notes are explained in “More about this receiver” (see pages 46 – 48).
- Button operations are mainly explained with the illustrations as follows:

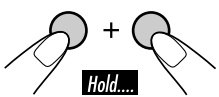
	Press briefly.
	Press repeatedly.
	Press either one.
	
	Press and hold until your desired response begins.
	Press and hold both buttons at the same time.

The following marks are used to indicate...

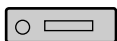

: Built-in CD player operations.



: External CD changer operations.



: SD card operations.

## How to forcibly eject a disc

If a disc cannot be recognized by the receiver or cannot be ejected, eject the disc as follows.

- If an SD card is inserted, eject the SD card first (see page 15).

1

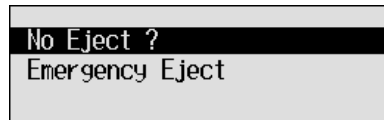
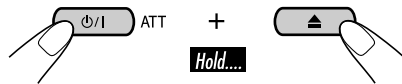

2

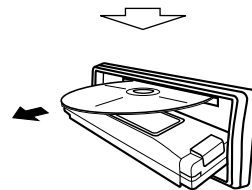
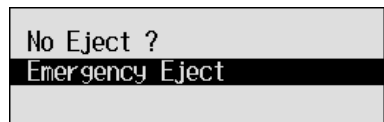
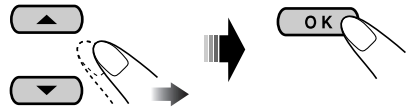

- If this does not work, reset your receiver.
- Be careful not to drop the disc when it ejects.

### Caution on volume setting:

Discs produce very little noise compared with other sources. Lower the volume before playing a disc to avoid damaging the speakers by the sudden increase of the output level.

## How to change the display pattern

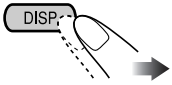

Ex.: When tuner is selected as the source

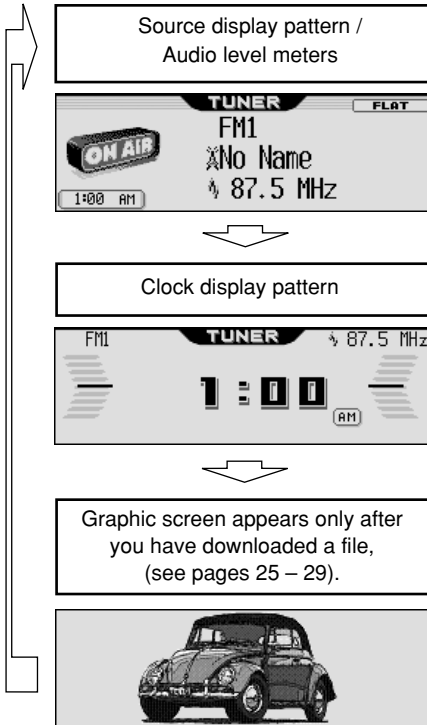

- If the current source is “SIRIUS,” see page 44 for details.

## How to enter the various menus

The main menu contains six menus (MODE, PSM, SEL, PICT, EQ, TITLE).

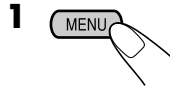

- 2 Move the cursor to select a menu you want (MODE, PSM, SEL, PICT, EQ, TITLE).

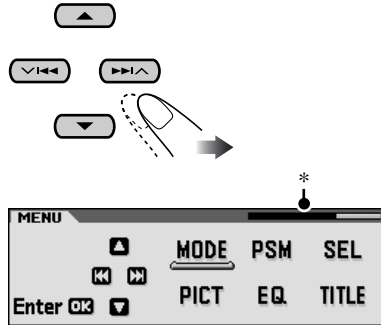

- To go back to the previous screen, press BACK.
- \* Works as time countdown indicator.

- 3 Enter the selected menu.

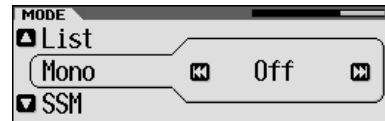

Ex.: When MODE menu is selected

- To go back to the MENU screen, press MENU.

- 4 Operate as instructed on the screen.

## Parts identification

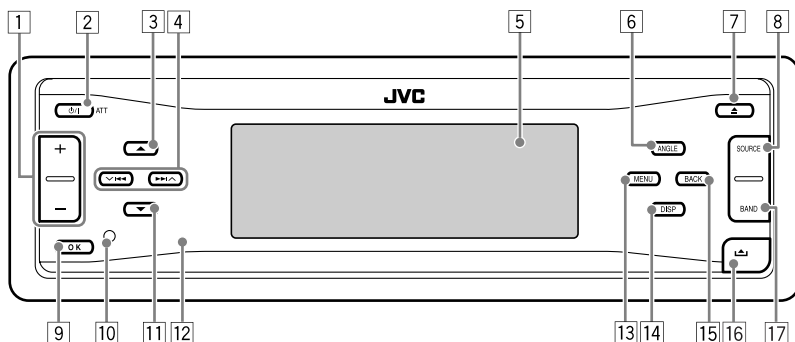

- 1 + / - button
- 2  $\phi$ /I ATT (standby/on attenuator) button
- 3 ▲ (up) button
- 4 ▼ ◀▶▶▶ ▲ buttons
- 5 Display window
- 6 ANGLE button
- 7 ▲ (eject) button
- 8 SOURCE button
- 9 OK button
- 10 Reset button

- 11 ▼ (down) button
- 12 Remote sensor
  - *DO NOT* expose the remote sensor to strong light (direct sunlight or artificial lighting).
- 13 MENU button
- 14 DISP (display) button
- 15 BACK button
- 16 ▲ (control panel release) button
- 17 BAND button

## Installing the lithium coin battery (CR2025)

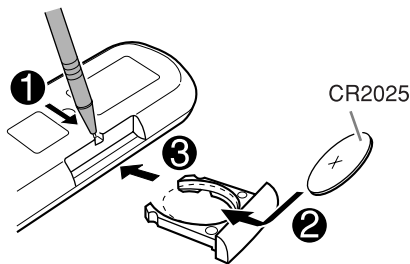

- When operating, aim the remote controller directly at the remote sensor on the receiver. Make sure there is no obstacle in between.

### Warning:

- Store the battery in a place where children cannot reach to avoid risk of accident.
- To prevent the battery from over-heating, cracking, or starting a fire:
  - Do not recharge, short, disassemble, or heat the battery or dispose of it in a fire.
  - Do not leave the battery with other metallic materials.
  - Do not poke the battery with tweezers or similar tools.
  - Wrap the battery with tape and insulate when throwing away or saving it.

### Caution:

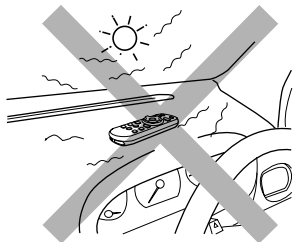

## Main elements and features

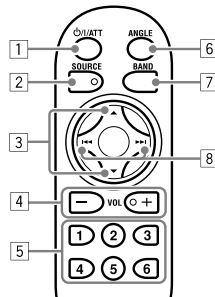

- 1 **⏻/ATT** (standby/on/attenuator) button
  - Turns on and off the power and also attenuates the sound.
- 2 **SOURCE** button
  - Selects the source.
- 3 **▲ (up) / ▼ (down)** buttons
  - Changes the preset stations.
  - Changes the categories for SIRIUS®.
  - Changes the MP3/WMA folders.
- 4 **VOL (volume) + / -** buttons
  - Adjusts the volume level.
- 5 **Number buttons**
  - Selects the preset station if pressed, or store a station if pressed and held.
  - Selects the preset channels while listening to SIRIUS radio, or store a channel if pressed and held.
  - Selects the tracks while playing an audio CDs or CD Texts.
  - Selects the folders while playing MP3/WMA discs or an SD card.
  - Selects the discs while operating the CD changer.
- 6 **ANGLE** button
  - Adjusts the control panel angle.
- 7 **BAND** button
  - Selects the band for FM/AM and SIRIUS.
- 8 **◀◀ / ▶▶** buttons
  - Searches for stations if pressed, or skips frequencies after pressed and held.
  - Changes the tracks of the disc or of the SD card if pressed.
  - Fast-forwards or reverses the track if pressed and held.
  - While listening to the SIRIUS radio:
    - Changes the channels if pressed briefly.
    - Changes the channels rapidly if pressed and held.

# Getting started

## Basic operations

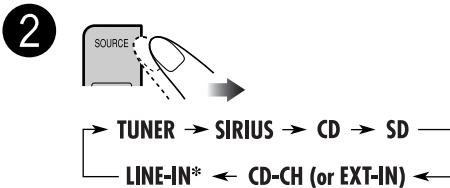
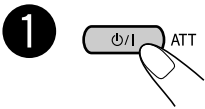
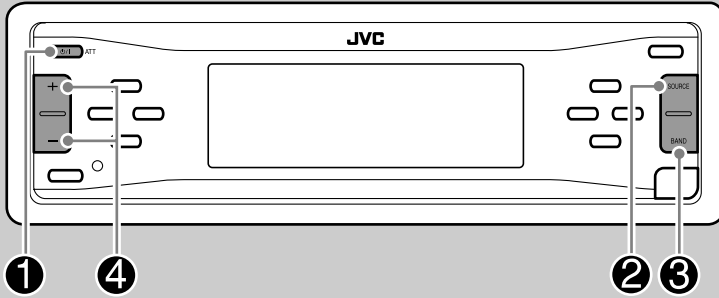

You cannot select some sources if they are not ready.

\* Only for KD-AR960.

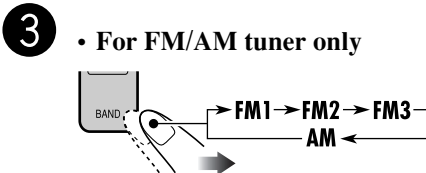

• For SIRIUS® radio only

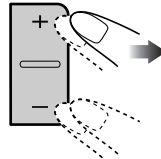
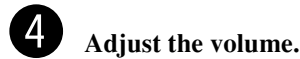
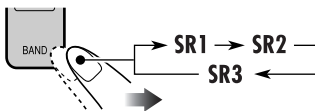

To show the level meter (see page 32).

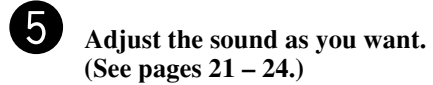
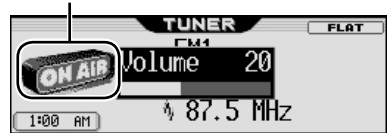

### To drop the volume in a moment (ATT)

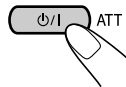

To restore the sound, press it again.

### To turn off the power

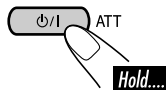



## Canceling the display demonstrations

If no operations are done for about 20 seconds, display demonstration starts.

[Initial: Demo]—see page 30.

- 1 Enter the PSM menu (see page 5).
- 2 Select “Off.”
  - Make sure “Demo/Link” is shown on the display. If not, press ▲ or ▼.

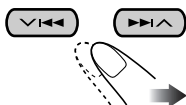

- 3 Exit from the setting.



### To activate the display demonstration

In step 2 above, select “Demo” or “Image Link.” For more details, see page 30.

## Setting the clock

- 1 Enter the PSM menu (see page 5).
- 2 Set the hour, minute, and clock system.
  - 1 Select “Clock Hr” (hour), then adjust the hour.
  - 2 Select “Clock Min” (minute), then adjust the minute.
  - 3 Select “24H/12H,” then select “24Hours” or “12Hours.”

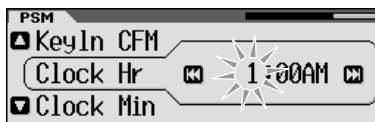
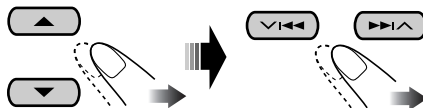

- 3 Exit from the setting.



### To check the current clock time when the power is turned off

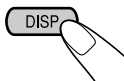

# Radio operations

ENGLISH

## Listening to the radio

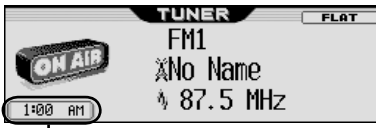
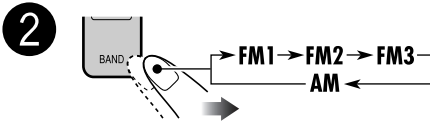
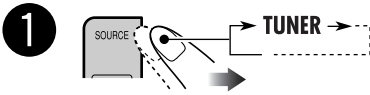
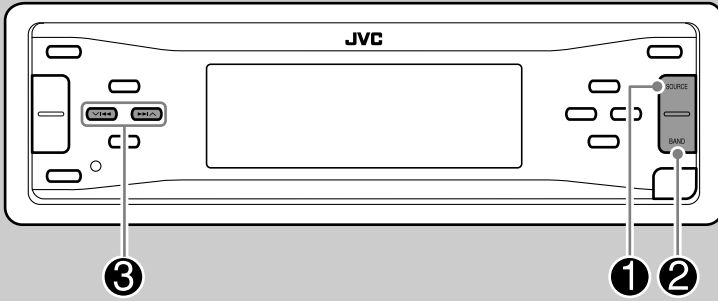

Clock display

3 Start searching for a station.

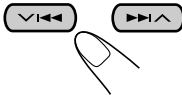

When a station is received, searching stops.

To stop searching, press the same button again.

### To tune in to a station manually

In step 3 on the left...

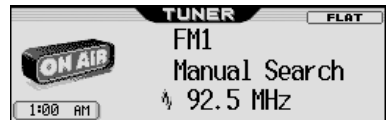

2 Select the desired station frequencies.

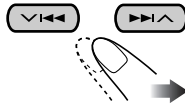

## When an FM stereo broadcast is hard to receive

1 Enter the MODE menu (see page 5).

2 Select “Mono.”

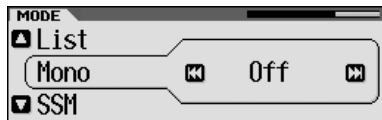
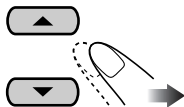

3 Select “On.”

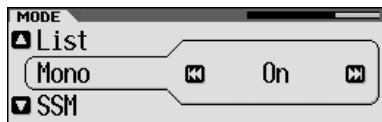
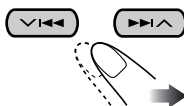

Reception improves, but stereo effect will be lost.

4 Exit from the setting.



To restore the stereo effect, repeat the same procedure and select “Off” on step 3.

## Storing stations in memory

You can preset six stations for each band.

### FM station automatic presetting—SSM (Strong-station Sequential Memory)

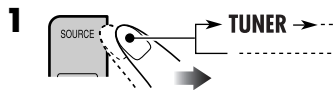

2 Select the FM band (FM1 – FM3) you want to store into.

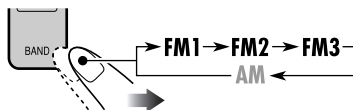

3 Enter the MODE menu (see page 5).

4 Select “SSM.”

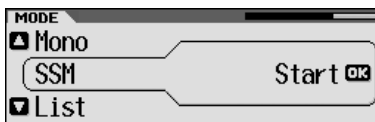
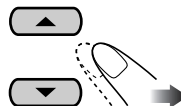

5

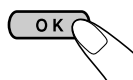

Local FM stations with the strongest signals are searched and stored automatically in the FM band.

## Manual presetting

Ex.: Storing FM station of 92.5 MHz into preset number 4 of the FM1 band.

- 1
- 2
- 3

• By holding ▲/▼, the Preset Station List will also appear (see step 7 below).

4 Enter the MODE menu (see page 5).

5 Select “List.”

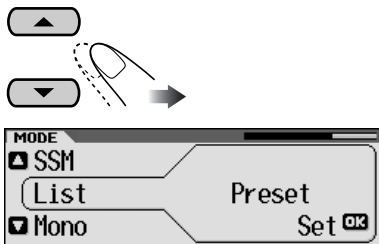

6

7 Select a preset number.

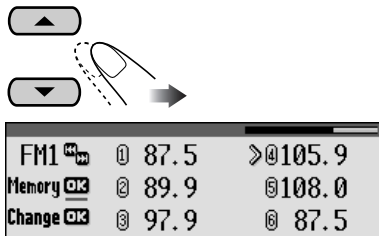

• If the current band is FM, you can move to the lists of the other FM bands by pressing ◀◀/▶▶.

8 Store the station.

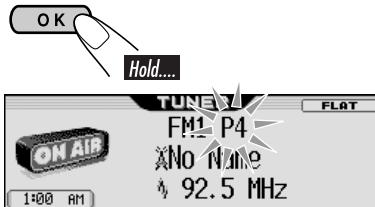

## Listening to a preset station

- 1
- 2

3 Perform steps 4 to 7 (on left column) to enter the Preset Station List.

4

# Disc/SD card operations

## Playing a disc in the receiver

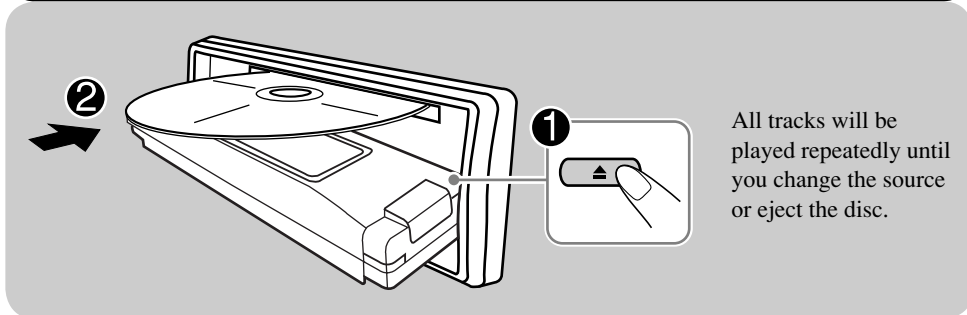

All tracks will be played repeatedly until you change the source or eject the disc.

### About MP3 and WMA discs

MP3 and WMA (Windows Media® Audio) “tracks” (words “file” and “track” are used interchangeably) are recorded in “folders.”

- When an MP3 or a WMA folder includes an image <jll> file edited by Image Converter (Wide Ver 1.2)—supplied in the CD-ROM, you can show the image on the display while the tracks in the folder are played back—Image Link. (See pages 15, 30, and 48 for details.)

### When inserting an MP3 or a WMA disc:

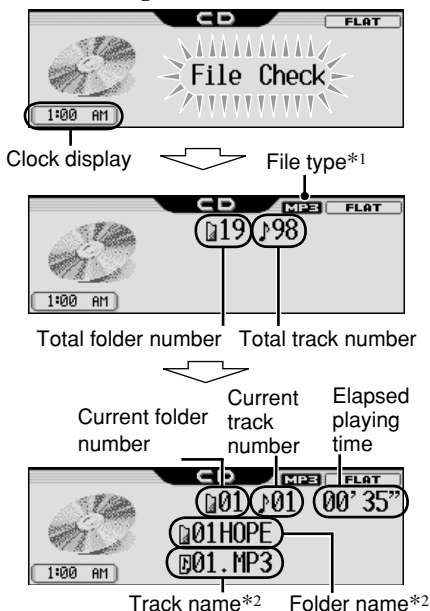

### When inserting an audio CD or a CD Text disc:

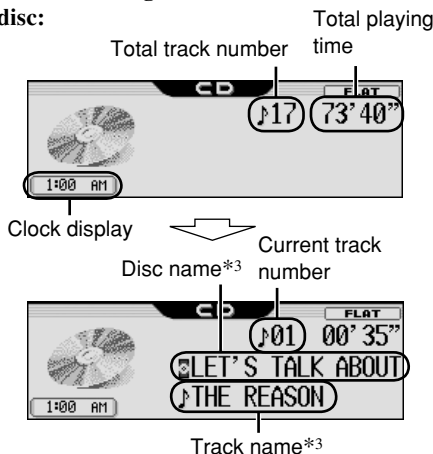

\*1 Either the MP3 or WMA indicator lights up depending on the detected file.

\*2 The album name/performer with indicator and the track title with indicator will appear if “ID3 Tag” is set to “On” (see page 32).

\*3 Appear only for CD Texts and CDs if it has been assigned or recorded. (“No Name” appears for a while if no name is recorded or assigned to an audio CD.)

### To stop play and eject the disc

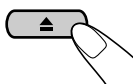

To return the control panel to its previous position, press it again.

## Playing discs in the CD changer

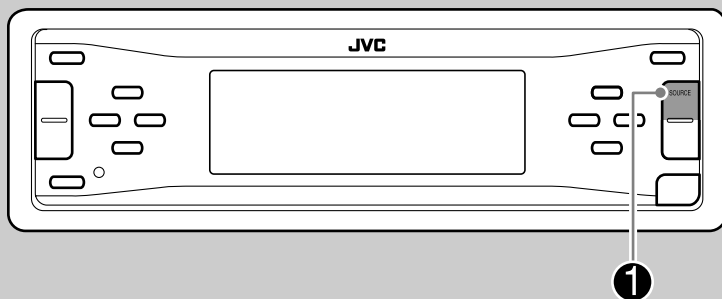

### About the CD changer

It is recommended to use the JVC MP3-compatible CD changer with your receiver.

- You can also connect other CH-X series CD changers (except CH-X99 and CH-X100). However, they are not compatible with MP3 discs, so you cannot play back MP3 discs.
- You cannot use the KD-MK series CD changers with this receiver.
- Disc text information recorded in the CD Text can be displayed when a JVC CD Text compatible CD changer is connected.
- You cannot control and play any WMA disc in the CD changer.

All tracks of the inserted discs in the magazine will be played repeatedly until you change the source or eject the magazine from the CD changer.

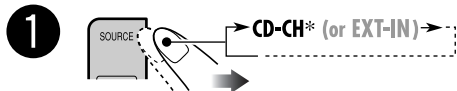

\* If you have changed "Ext Input" setting to "Ext In" (see page 32), you cannot select the CD changer.

- When the current disc is an MP3 disc:

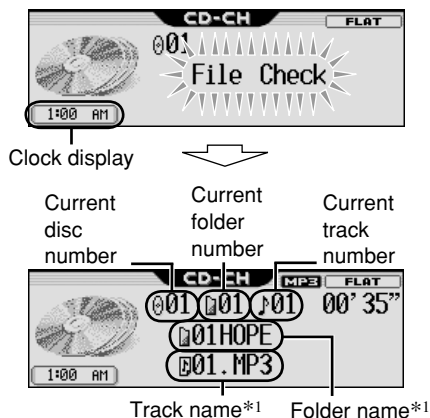

- When the current disc is an audio CD or a CD Text disc:

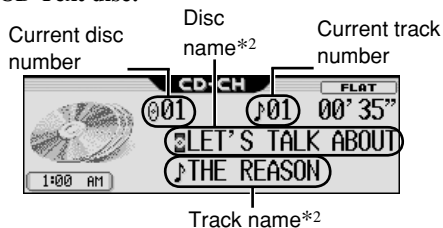

\*1 The album name/performer with indicator and the track title with indicator will appear if "ID3 Tag" is set to "On" (see page 32).

\*2 Appear only for CD Texts and CDs if it has been assigned or recorded. ("No Name" appears for a while if no name is recorded or assigned to an audio CD.)

## Playing an SD card

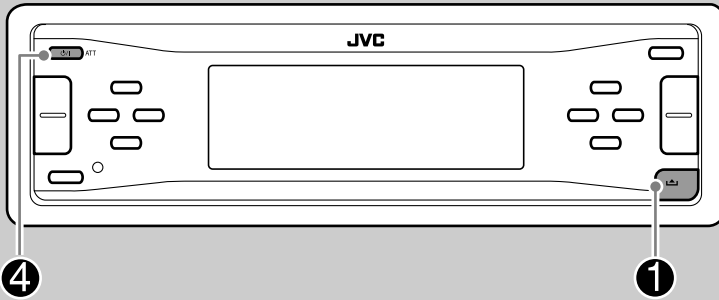

### About the SD card

You can play back MP3/WMA tracks recorded on the SD card and show the stored image on the display during playback—Image Link. (See pages 13, 30, and 48 for details.)

The required SD recording format is FAT 12/16 and the recommended storage type is 8 MB to 512 MB.

- You cannot use MMC or mini SD with this receiver.

Before detaching the control panel, turn off the power.

### 1 Detach the control panel.

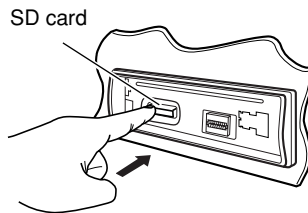
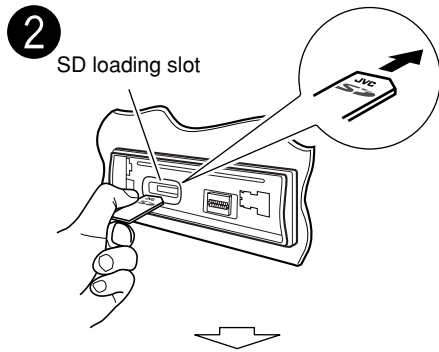
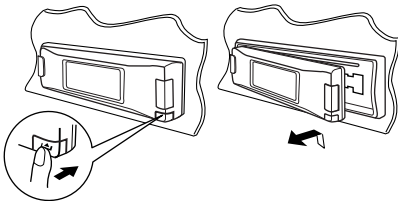

Press in the SD card until you hear a clicking sound.

To eject the SD card, press the SD card again.

To be continued....

**3** Attach the control panel.

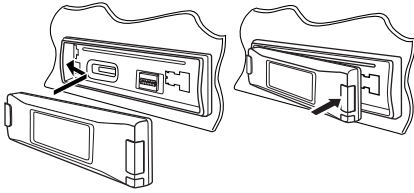

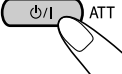

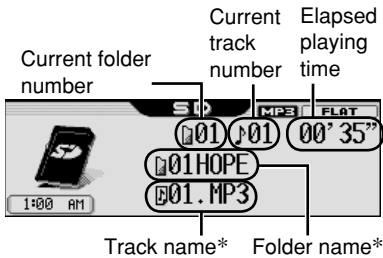
**4**  ATT • The control panel goes back to the previous position (see page 38).

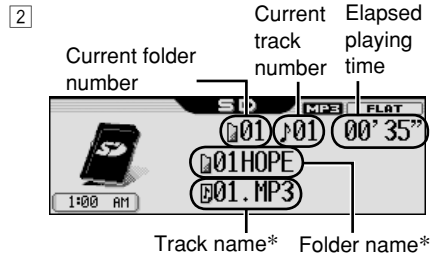

Playback starts automatically if tracks are recorded.

**If an SD Card has been loaded....**



\* The album name/performer with  indicator and the track title with  indicator will appear if "ID3 Tag" is set to "On" (see page 32).



## To fast-forward or reverse the track

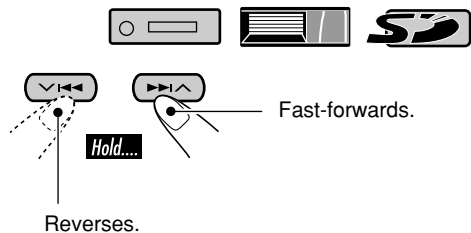

## To go to the next or previous tracks

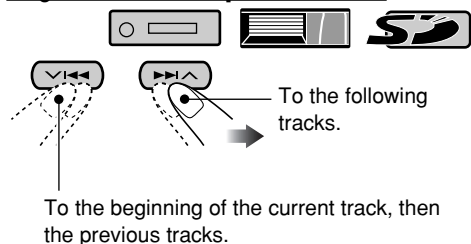

## To go to the next or previous folders (only for MP3 and WMA tracks)

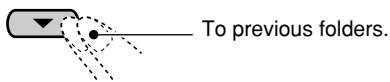
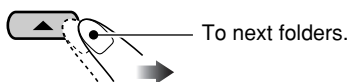

: Holding these buttons can display the Disc List (see next column).

: Holding these buttons can display the Folder List (see page 18).

## Other main functions

### Selecting a disc/folder/track on the list



1 Enter the MODE menu (see page 5).

2 Select "List."

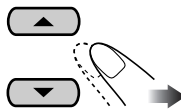

3 Select the list type—"Disc,"\*1  
"Folder,"\*2 or "File."\*2

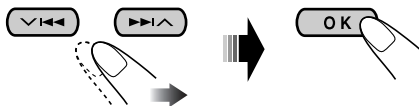

\*1 Selectable only when the source is "CD-CH."

\*2 Selectable only for MP3/WMA disc or SD card.



1 When "Disc" is selected:

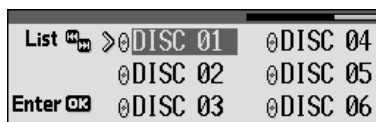

Disc List appears.

- You can move to the other lists by pressing  $\leftarrow \rightarrow \leftarrow \rightarrow \leftarrow \rightarrow \leftarrow \rightarrow$  ( $\uparrow/\downarrow$ ).

To be continued....

**To start playback.**

- If you select the current MP3 disc (highlighted on the display), its Folder List appears.

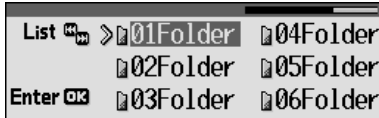
**2 When “Folder” is selected:**

Folder List appears.

- You can move to the other lists by pressing  $\leftarrow/\rightarrow$  ( $\blacktriangle/\blacktriangledown$ ).

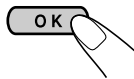
**To start playback.**

- If you select the current folder (highlighted on the display), its File List appears.

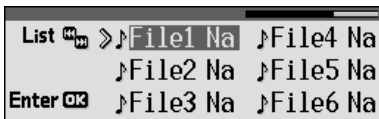
**3 When “File” is selected:**

File List appears.

- You can move to the other lists by pressing  $\leftarrow/\rightarrow$  ( $\blacktriangle/\blacktriangledown$ ).

**To start playback.****When using the remote controller....**

- To directly select a disc in the CD changer
- To directly select a track of an audio CD or a CD Text
- To directly select a folder of an MP3/WMA disc or an SD card

To select a number from 1 – 6:

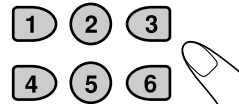

To select a number from 7 (1) – 12 (6):

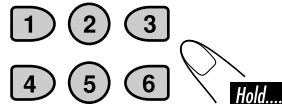

It is required that folders are assigned with 2-digits number at the beginning of their folder names—01, 02, 03, and so on.

## Prohibiting disc ejection

You can lock a disc in the loading slot.

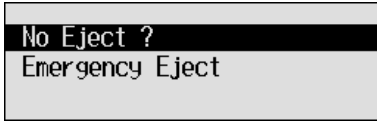
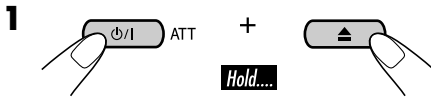

**2** Select “No Eject ?”

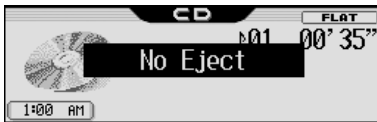

“No Eject” flashes, and the disc cannot be ejected.

### To cancel the prohibition

Repeat the same procedure, press OK in step **2** after making sure that “Eject OK ?” is selected (highlighted). “Eject OK” flashes.

## Selecting the playback modes



You can use only one of the following playback modes at a time.

**1** Enter the MODE menu (see page 5).

**2** Select one of the playback modes—“Intro,” “Repeat,” or “Random.”

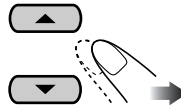

**3** Select your desired playback modes.

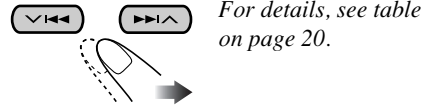

**4** Finish the procedure.



To be continued....

## Intro play

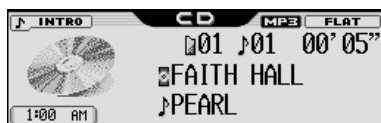

Ex.: When "Track Intro" is selected while playing an MP3 disc in the receiver

## Repeat play



Ex.: When "Track Repeat" is selected while playing an MP3 disc in the receiver

## Random play

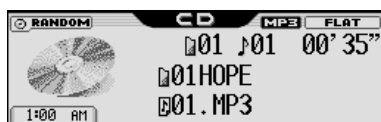

Ex.: When "Disc Random" is selected while playing an MP3 disc in the receiver

## Mode Plays the beginning 15 seconds of...

- Track:** All tracks of the current disc or the SD card.
- While playing, **INTRO** lights up.
- Folder\*<sup>1</sup>:** First tracks of all folders of the current disc or the SD card.
- While playing, **INTRO** lights up.
- Disc\*<sup>2</sup>:** First tracks of all the inserted discs.
- While playing, **INTRO** lights up.
- Off:** Cancels.

## Mode Plays repeatedly

- Track:** The current track.
- While playing, **REPEAT** lights up.
- Folder\*<sup>1</sup>:** All tracks of the current folder.
- While playing, **REPEAT** lights up.
- Disc\*<sup>2</sup>:** All tracks of the current disc.
- While playing, **REPEAT** lights up.
- Off:** Cancels.

## Mode Plays at random

- Folder\*<sup>1</sup>:** All tracks of the current folder, then tracks of the next folder and so on.
- While playing, **RANDOM** lights up.
- Disc or SD:** All tracks of the current disc or the SD card.
- While playing, **RANDOM** or **RANDOM** lights up.
- All\*<sup>2</sup>:** All tracks of the inserted discs.
- While playing, **RANDOM** lights up.
- Off:** Cancels.

\*<sup>1</sup> Only while playing MP3 ( / / ) or WMA ( / ) track.

\*<sup>2</sup> Only while playing discs in the CD changer ( ).

# Sound adjustments

## Setting the basic sound selection menu — SEL

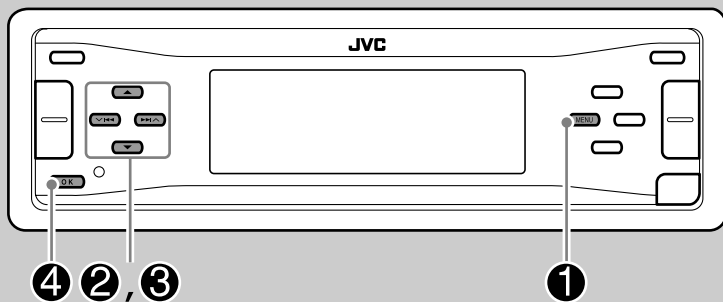

You can adjust the sound characteristics to your preference.

- 1 Enter the SEL menu (see page 5).
- 2 Select a setting item—"Fad/Bal," "Subwoofer," "VolAdjust," or "Loudness."

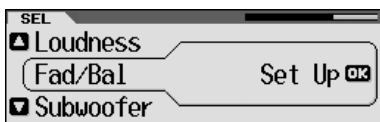
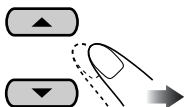

When selecting "Fad/Bal" and "Subwoofer," press OK to enter the selected menu.

- 3 Adjust the selected setting item.

### A Fad/Bal



- 1 To adjust the speaker output balance between the front and rear speakers—Front to Rear.

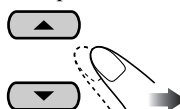

- 2 To adjust the speaker output balance between the left and right speakers—Left to Right.

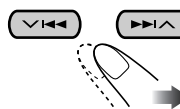

- 3 BACK

To be continued...

## Ⓑ Subwoofer

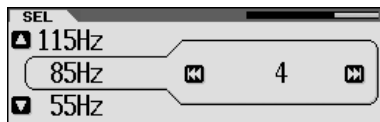

- 1 To select the cutoff frequency to the subwoofer.

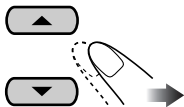

---

**55Hz:** Frequencies higher than 55 Hz are cut off to the subwoofer.

---

**85Hz:** Frequencies higher than 85 Hz are cut off to the subwoofer.

---

**115Hz:** Frequencies higher than 115 Hz are cut off to the subwoofer.

- 2 Adjust the subwoofer output level.



## Ⓒ VolAdjust

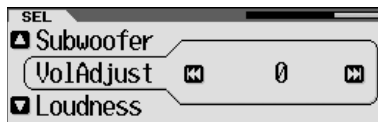

To adjust the input level of each source (except FM).  
Adjust to match the input level to the FM sound level.

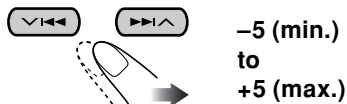

## Ⓓ Loudness



To adjust the loudness to produce a well-balanced sound at low volume levels.



- 4 Exit from the setting.

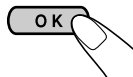

## Selecting preset sound modes (i-EQ: intelligent equalizer)

You can select a preset sound mode suitable to the music genre.

### Available sound modes

**Flat** (No sound mode is applied),  
**Hard Rock, R&B** (Rhythm&Blues),  
**Pop, Jazz, Dance, Country, Reggae,**  
**Classic, User 1, User 2, User 3**

**1** Enter the EQ menu (see page 5).

**2** Select a sound mode.

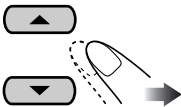

Ex.: When "Flat" is selected

**3** Exit from the setting.

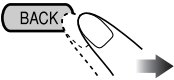

## Storing your own sound modes

You can adjust the sound mode and store your own adjustments in memory.

**1** Enter the EQ menu (see page 5).

**2** Select a sound mode (see step 2 above).



**4** Select the sound elements to adjust.

**(A) Adjust the enhancement level**

**1** Select "Low," "Mid," or "High."

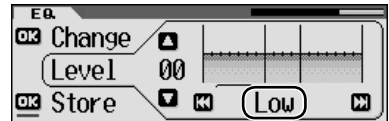
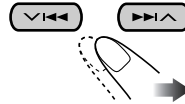

**2** Adjust the level (-06 to +06).

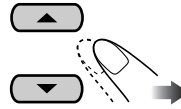

**(B) Select a center frequency**

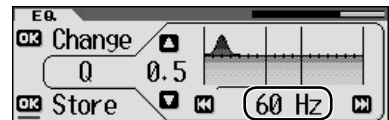
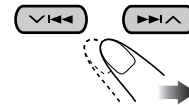

To be continued...

**C Select a band width**

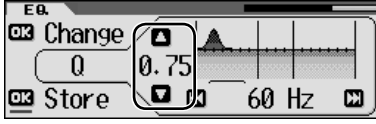
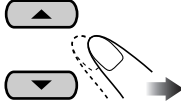

Indication	Preset values		
	Low	Mid	High
Level	-06 (min.) to +06 (max.)	-06 (min.) to +06 (max.)	-06 (min.) to +06 (max.)
Center frequency	60Hz 80Hz 100Hz 120Hz	Fix	8kHz 10kHz 12kHz 15kHz
Q (Band width)	Q 0.5 Q 0.75 Q 1.0 Q 1.25	Q 1.0 Q 1.85	Fix

- Pressing OK button, will go back to the beginning display.

**5 Repeat step 4 to adjust the other frequency bands.**

**6 Store the adjustments.**

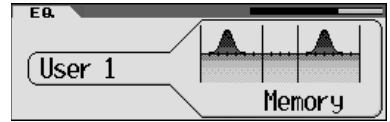
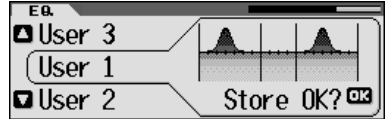
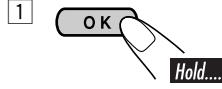

Ex.: When "User 1" is selected

The list below shows the preset value settings for each sound modes:

Indication	Preset values						
	Low			Mid		High	
	Level	Center frequency	Q (Band width)	Level	Q (Band width)	Level	Center frequency
Flat	00	60Hz	Q 0.5	00	Q 1.0	00	8kHz
Hard Rock	+03	120Hz	Q 1.25	00	Q 1.0	+02	8kHz
R&B	+03	80Hz	Q 0.5	+01	Q 1.0	+03	15kHz
Pop	+02	120Hz	Q 0.5	+01	Q 1.0	+02	10kHz
Jazz	+03	80Hz	Q 0.5	00	Q 1.0	+03	10kHz
Dance	+04	60Hz	Q 0.75	-02	Q 1.85	+01	8kHz
Country	+02	60Hz	Q 1.0	00	Q 1.0	+02	12kHz
Reggae	+03	60Hz	Q 0.5	+02	Q 1.0	+02	12kHz
Classic	+01	80Hz	Q 0.5	00	Q 1.0	+03	10kHz



## Basic procedure

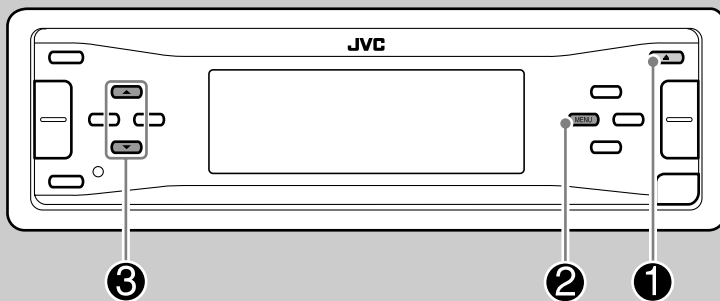

Before starting the following procedure, prepare a CD-R or an SD card including still images (pictures) and animations (movies).

- With Image Converter (Wide Ver 1.2) included in the supplied CD-ROM, you can create your own images and animations. (Samples are included in the CD-ROM.)

**1** Insert a CD-R, an SD card, or supplied CD-ROM.

- CD-R/supplied CD-ROM

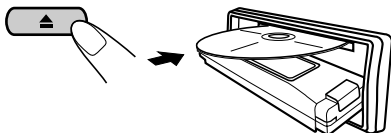

- SD card

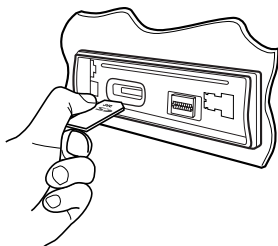

**2** Enter the PICT menu (see page 5).

**3** Select the item.

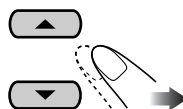

Ex.: When “Delete” is selected

- To download the file(s):  
→ “Download” (see page 26)
- To delete the file(s):  
→ “Delete” (see page 27)
- To delete all files:  
→ “All Delete” (see page 28)
- To activate the file(s):  
→ **Activating the downloaded files** (see page 29)

To be continued...

**IMPORTANT:**

- Refer also to Image Converter PDF files included in the “Manual” folder of the supplied CD-ROM.
- Still images (pictures) should have <jll>, and animations (movies) should have <jla> as their extension code in their file names.
- Before you download or delete the files, observe the following:
  - Do not download a file while driving.
  - Do not turn off the ignition key of the car while downloading or deleting a file.\*
  - Do not detach the control panel while downloading or deleting a file.\*

\* If you do so, the file download or deletion will not be done correctly.

## Downloading the files

- **Picture:** Graphic screen  
To download/delete still images (30 still images at maximum) which will be shown while playing a source.
- **Movie:** Graphic screen  
To download/delete an animation (90 frames at maximum) which will be shown while playing a source.
- **Opening:** Opening screen  
To download/delete an animation (30 frames at maximum) which will be shown after the receiver is turned on.
- **Ending:** Ending screen  
To download/delete an animation (30 frames at maximum) which will be shown before the receiver is turned off.

## ■ Downloading pictures or an animation

- It takes a long time to download an animation. For details, see page 48.
- To activate the downloaded files, see page 29.

**1** In step ③ on page 25, select “Download.”

**2** Select the screen type—“Picture,” “Movie,” “Opening,” or “Ending.”

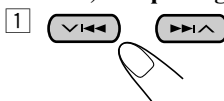

Ex.: When “Picture” is selected



**3** Select a folder.

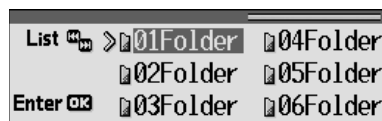
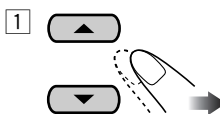

**4 Select a file.**

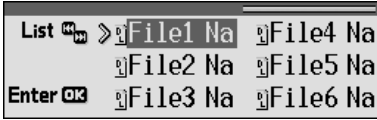
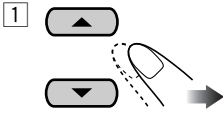

- You can move to the other lists by pressing **◀◀/▶▶**.



- When download is complete, the file list appears again.

- 5** • To download more pictures from the same folder, repeat step 4.  
 • To download more pictures from another folder, press **BACK**. Then, repeat steps 3 and 4.

**6 Exit from the setting.**

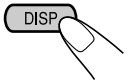

**Deleting the files**

**Deleting the stored pictures and animation**

**1** In step ③ on page 25, select “Delete.”

**2** Select the screen type—“Picture,” “Movie,” “Opening,” or “Ending.”

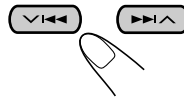

Ex.: When “Picture” is selected

**4** • To delete the stored pictures

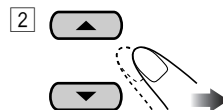
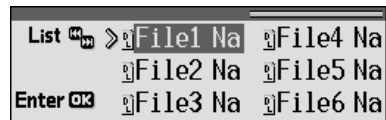

- You can move the other lists by pressing **◀◀/▶▶**.

To be continued...



- When a file is deleted, the File List appears again.

4 Repeat step 2 to delete more pictures.

- To delete the stored animation

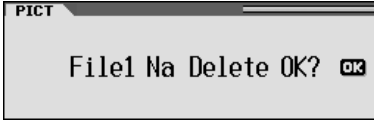

5 Exit from the setting.

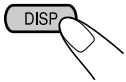

## ■ Deleting all the stored pictures and animation

### To delete all the stored pictures

1 In step 3 on page 25, select “Delete.”

2 Select “Picture.”

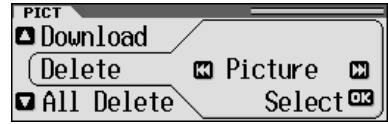
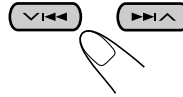

4 Select “All Delete.”

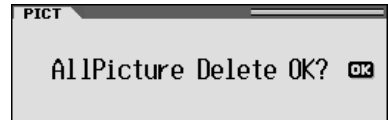
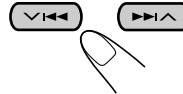

- When all pictures are deleted, the PICT menu appears again.

7 Exit from the setting.



## To delete all the stored files

1 In step 3 on page 25, select “All Delete.”



• When all files are deleted, the PICT menu appears again.

4 Exit from the setting.

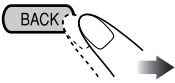

## Activating the downloaded files

1 Enter the PSM menu (see page 5).

2 Select “PICT.”

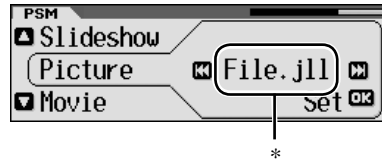
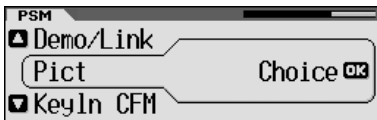
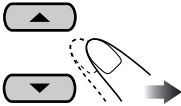

\* If there is no still images or animation downloaded, “No Picture,” “No Movie,” or “No Slide” will appear.

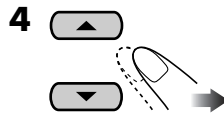

**Picture:** One of your edited still images stored in “Picture” is activated. → Go to step 5.

**Movie:** Your edited animation stored in “Movie” is activated. → Go to step 6.

**Slideshow:** Your edited still images stored in “Slide” are activated and shown in sequence. → Go to step 6.

5 Select a file.

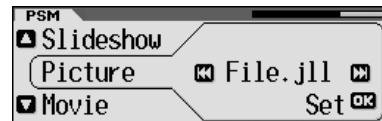
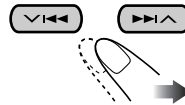

6 Finish the procedure.



# General settings — PSM

## Basic procedure

You can change PSM (Preferred Setting Mode) items listed in the table that follows.

**1** Enter the PSM menu (see page 5).

**2** Select a PSM item.

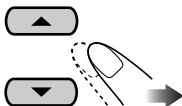

Ex.: When “Dimmer” is selected

**3** Adjust the setting.

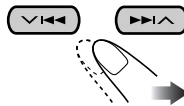

**4** Repeat steps 2 and 3 to adjust the other PSM items if necessary.

**5** Finish the procedure.

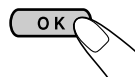

### Indications

### Selectable settings, [reference page]

**Demo/Link**  
Display demonstration

**Demo:** [Initial]; Display demonstration (animation) and playback source indication appears alternately.

**Image Link:** To show a still image while playing back an MP3/WMA track, [13, 15, 48].

**Off:** Cancels.

• These graphics appear if no operation is done for about 20 seconds.

**Pict**  
Pictures

You can activate the graphic screen using either movie or picture, [29].

**Picture:** [Initial]; One of your edited still images stored in “Picture” is activated.

**Movie:** Your edited animation stored in “Movie” is activated.

**Slideshow:** Your edited still images stored in “Slide” are activated and shown in sequence.

**KeyIn CFM**  
Key-in confirmation

**On:** [Initial]; An animation screen appears when you turn on or off the power and select an i-EQ.

**Off:** Cancels.

Indications	Selectable settings, [reference page]
<b>Opening</b> *1 Opening screen	<b>Default:</b> [Initial]; Factory-preset animation is used, [26]. <b>User:</b> Your own user animation is used.
<b>Ending</b> *1 Ending screen	
<b>Clock Hr</b> Clock hour	1 – 12 (0 – 23), [9] [Initial: 1 (1:00 AM)]
<b>Clock Min</b> Clock minute	00 – 59, [9] [Initial: 00 (1:00 AM)]
<b>24H/12H</b> Clock system	12Hours ⇄ 24Hours, [9] [Initial: 12Hours]
<b>Clock Adj</b> *2 Automatic clock adjustment	<b>Auto:</b> [Initial]; The built-in clock is automatically adjusted using the clock time data provided via the SIRIUS® radio channel. <b>Off:</b> Cancels.
<b>Time Zone</b> *2, *3 Time zone	Select your residential area from one of the following time zone for clock adjustment. <b>Eastern</b> [Initial] ⇄ <b>Atlantic</b> ⇄ <b>Newfndlnd</b> (Newfoundland) ⇄ <b>Alaska</b> ⇄ <b>Pacific</b> ⇄ <b>Mountain</b> ⇄ <b>Central</b> ⇄ (back to the beginning)
<b>DST</b> *2, *3 Daylight savings time	Activates this if your residential area is subject to DST. <b>On:</b> [Initial]; Activates daylight savings time. <b>Off:</b> Cancels.
<b>Scroll</b> Scroll mode	The entire text information can be shown by scrolling if it cannot be shown at a time. <b>Once:</b> [Initial]; Scrolls only once. <b>Auto:</b> Repeats scrolling (in 5-seconds interval). <b>Off:</b> Cancels. • Holding DISP for more than one second can scroll the display regardless of the setting.
<b>Dimmer</b> Dimmer mode	<b>Auto:</b> [Initial]; Dims the display when you turn on the headlights. <b>Off:</b> Cancels. <b>On:</b> Activates dimmer. <b>Time Set:</b> Set the timer for dimmer, [34].
<b>From– To</b> *4 Dimmer time	Any hour – Any hour, [34] [Initial: 6PM – 7AM]

\*1 Displayed only after a downloadable file is stored in memory.

\*2 Displayed only when SIRIUS radio is connected.

\*3 Displayed only when “Clock Adj” is set to “Auto.”

\*4 Displayed only when “Dimmer” is set to “Time Set.”

Indications	Selectable settings, [reference page]
<b>Contrast</b> Contrast	<b>1 – 10:</b> Adjust the display contrast to make the display indications clear and legible. <i>[Initial: 5]</i>
<b>LCD Type</b> Display type	<b>Auto:</b> <i>[Initial]</i> ; Positive pattern will be selected during the day time*1; while negative pattern will be used during the night time*1. <b>Positive:</b> Positive pattern of the display. <b>Negative:</b> Negative pattern of the display (except still images and animations).
<b>Font Type</b> Font type	You can select the font type on the display. <b>1</b> <i>[Initial]</i> ⇄ <b>2</b>
<b>ID3 Tag</b> Tag display	<b>On:</b> <i>[Initial]</i> ; To shows the ID3 tag display while playing MP3/WMA tracks, [13, 14, 16]. <b>Off:</b> Cancels.
<b>Theme</b> Audio level meter	You can select the level meter during playback. <b>SRC Anime</b> (Source Animation) <i>[Initial]</i> ⇄ <b>Meter 1</b> ⇄ <b>Meter 2</b> ⇄ <b>Meter 3</b> ⇄ (back to the beginning) • Press DISP repeatedly to show the selected level meter.
<b>IF Filter</b> Intermediate frequency filter	<b>Auto:</b> <i>[Initial]</i> ; Increases the tuner selectivity to reduce interference noises between the stations. (Stereo effect will also be lost.) <b>Wide:</b> Subject to the interference noises from adjacent stations, but sound quality will not be degraded and remaining the stereo effect.
<b>AreaChange</b> Tuner channel interval	<b>EU:</b> Select this when using the receiver in an area other than North and South America. (FM: 50 kHz—manual tuning, 100 kHz—auto search; AM: 9 kHz) <b>US:</b> <i>[Initial]</i> ; Select this when using the receiver in North or South America. (FM: 200 kHz; AM: 10 kHz)
<b>Sirius ID</b> *2 SIRIUS® ID	The 12-digits SIRIUS identification number is shown on the display, [40].
<b>Beep</b> Key-touch tone	<b>On:</b> <i>[Initial]</i> ; Activates the key-touch tone. <b>Off:</b> Deactivates the key-touch tone.
<b>Ext Input</b> *3 External input	<b>Changer:</b> <i>[Initial]</i> ; To use a JVC CD changer, [14]. <b>Ext In:</b> To use any external component (other than SIRIUS DLP), [39].



Indications	Selectable settings, [reference page]
<b>Telephone*</b> <sup>4</sup> Telephone muting	<b>Muting1/Muting2:</b> Select either one which mutes the sounds while using the cellular phone. <b>Off:</b> [Initial]; Cancels. <ul style="list-style-type: none"> <li>If CD or CD changer has been selected as the source, playback pauses during telephone muting.</li> </ul>
<b>Amp Gain</b> Amplifier gain control	You can change the maximum volume level of this receiver. <b>High PWR:</b> [Initial]; Volume 00 – Volume 50 <b>Low PWR:</b> Volume 00 – Volume 30 (Select this if the maximum power of the speaker is less than 50 W to prevent them from damaging the speaker.) <b>Off*</b> <sup>4</sup> : Deactivates the built-in amplifier.
<b>Color Sel</b> Color selection	[Initial: AllSource]; You can select your favorite display color for each source (or for all sources), [35].
<b>Color Set</b>	You can create your own colors, and select them for the display color, [36].
<b>Red</b> <b>Green</b> <b>Blue</b>	<b>Day Color:</b> User color during the day time* <sup>1</sup> . <b>NightColor:</b> User color during the night time* <sup>1</sup> . 00 – 11 [Initial: Day Color: 07, NightColor: 05] 00 – 11 [Initial: Day Color: 07, NightColor: 05] 00 – 11 [Initial: Day Color: 07, NightColor: 05]

\*<sup>1</sup> Depends on the “Dimmer” setting.

\*<sup>2</sup> Displayed only when SIRIUS radio is connected.

\*<sup>3</sup> Cannot be selected if the source is “CD-CH” or “EXT-IN.”

\*<sup>4</sup> Only for KD-AR960.

## Selecting the dimmer mode

You can dim the display at night or as you set the timer.

**1** Enter the PSM menu (see page 5).

**2** Select “Dimmer.”

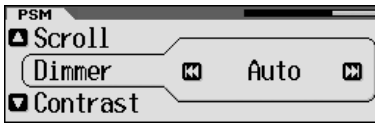
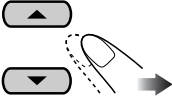

**3** Select a setting.

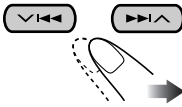

<b>Auto:</b>	Dims the display when you turn on the headlights. → Go to step <b>6</b> .
<b>Off:</b>	Cancels. → Go to step <b>6</b> .
<b>On:</b>	Always dims the display. → Go to step <b>6</b> .
<b>Time Set:</b>	Set the timer for dimmer. → Go to step <b>4</b> .

**4** Enter the Time Set screen.

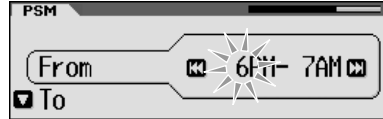

**5** Adjust the dimmer time.

**1** Set the dimmer start time.

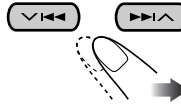

**2** Set the dimmer end time.

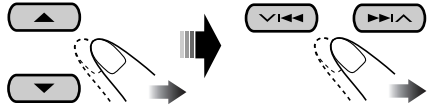

**6** Finish the procedure.



## Changing the display color

You can select your favorite display color for each source (or for all sources).

### Setting the display color

**1** Enter the PSM menu (see page 5).

**2** Select “Color Sel.”

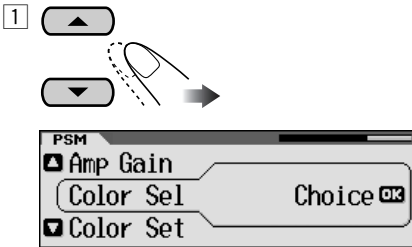

**3** Select the source.

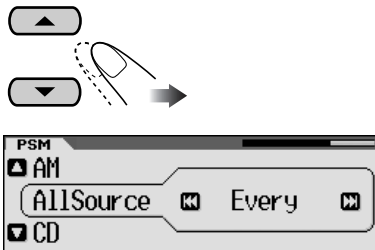

Ex.: When “AllSource” is selected

AllSource\*<sup>1</sup> ◀ CD ◀ SD ◀ Changer  
 (or Ext In\*<sup>2</sup>) ◀ Line In\*<sup>3</sup> ◀ FM ◀ AM  
 ◀ Sirius\*<sup>4</sup> ◀ (back to the beginning)

- \*<sup>1</sup> When you select “AllSource,” you can use the same color for all the sources.
- \*<sup>2</sup> Depends on the “Ext Input” setting, see page 32.
- \*<sup>3</sup> Only for KD-AR960.
- \*<sup>4</sup> Appears only when SIRIUS radio is connected.

**4** Select the color.

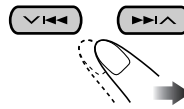

Every\*<sup>5</sup> ◀ Aqua ◀ Sky ◀ Sea ◀  
 Leaves ◀ Grass ◀ Apple ◀ Rose ◀  
 Amber ◀ Honey ◀ Violet ◀ Grape ◀  
 Pale ◀ User\*<sup>6</sup> ◀ (back to the  
 beginning)

\*<sup>5</sup> The color changes every 2 seconds.

\*<sup>6</sup> The user-edited colors—“Day Color” and “NightColor” will be applied (see page 36 for details).

**5** Repeat steps 3 and 4 to select the color for each source (except when selecting “AllSource” in step 3).

**6** Finish the procedure.



## ■ Creating your own color—User

You can create your own colors—“Day Color” and “NightColor.”

**1** Enter the PSM menu (see page 5).

**2** Select “Color Set.”

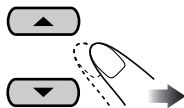

**3** Select “Day Color” or “NightColor.”

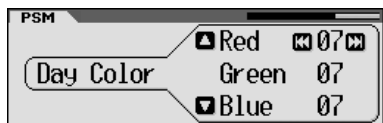
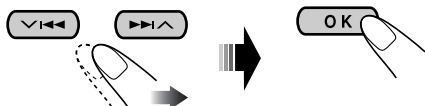

Ex.: When “Day Color” is selected

**4** Select the primary colors—“Red,” “Green,” or “Blue.”

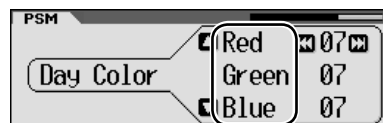
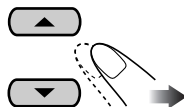

**5** Adjust the level (00 – 11) of the selected primary color.

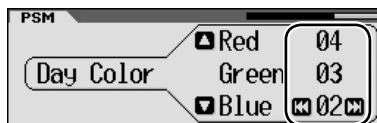
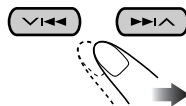

**6** Repeat step 4 and 5 to adjust the other primary colors.

**7** Finish the procedure.

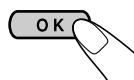

# Other main functions

## Assigning titles to the sources

You can assign titles to station frequencies, CDs (both in this receiver and in the CD changer), and the external components.

Sources	Maximum number of characters
Station frequencies	Up to 10 characters (up to 30 station frequencies including both FM and AM)
CDs/CD-CH*1	Up to 32 characters (up to 30 discs)
External components ("EXT-IN" or "LINE-IN"*2)	Up to 8 characters

\*1 You cannot assign a title to a CD Text or an MP3/WMA disc.

\*2 Only for KD-AR960.

### 1 Select the source.

- For FM/AM tuner: Select a station.
- For a CD in this receiver: Insert a CD.
- For CDs in the CD changer: Select "CD-CH," then select a disc number.
- For external components: Select "EXT-IN" or "LINE-IN"\*2 (see page 32).

### 2 Enter the TITLE menu (see page 5).

### 3 Assign a title.

#### 1 Select a character set.

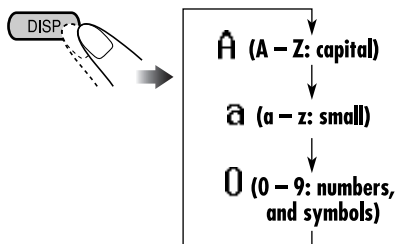

Ex.: When you assign a title to a CD

#### 2 Select a character.

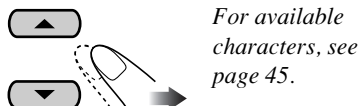

#### 3 Move to the next (or previous) character position.

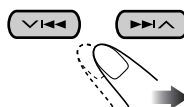

#### 4 Repeat steps 1 to 3 until you finish entering the title.

### 4 Finish the procedure.



### To erase the entire title

In step 3 on the left...



## Changing the control panel angle

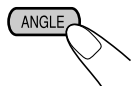

The control panel changes its angle as follows:

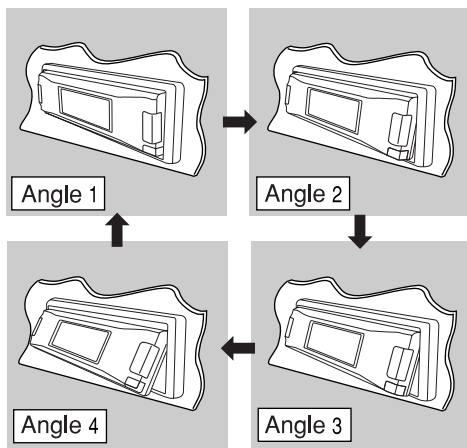

### When using the remote controller...

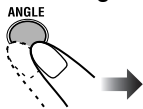

#### Caution:

Do not insert your finger behind the control panel.

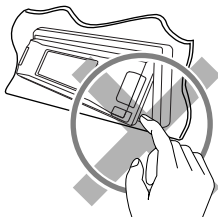

## Detaching the control panel

When detaching or attaching the control panel, be careful not to damage the connectors on the back of the control panel and on the panel holder.

### Detaching the control panel

Before detaching the control panel, be sure to turn off the power.

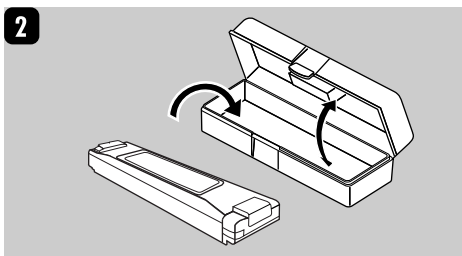
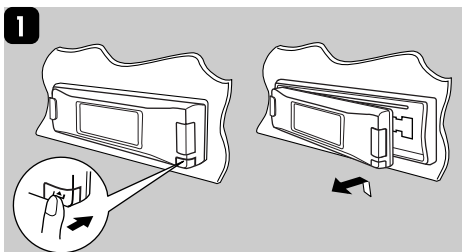

### Attaching the control panel

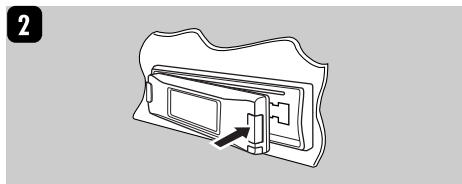
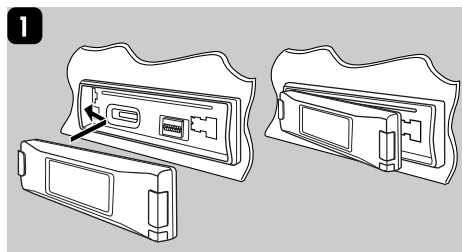

# External component operations

## Playing an external component

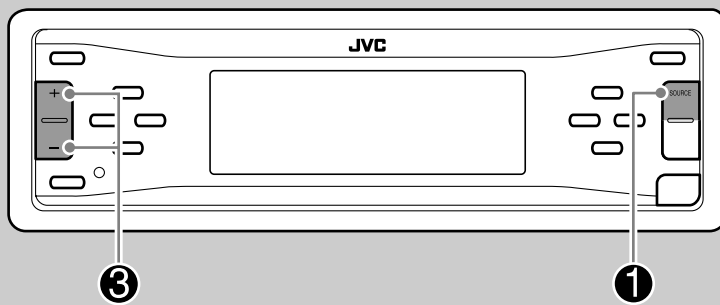

### For KD-AR960:

You can connect an external component to the LINE IN plugs on the rear.

### For KD-AR960/KD-LH910:

You can connect an external component to the CD changer jack on the rear using the Line Input Adapter KS-U57 (not supplied). Before operating the external component, select the external input correctly (see page 32).

- For connection, see Installation/Connection Manual (separate volume).

### For KD-LH910:

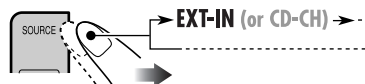

- If “EXT-IN” does not appear, see page 32.

### 1 For KD-AR960:



LINE-IN: For selecting the external component connected to the LINE IN plugs.

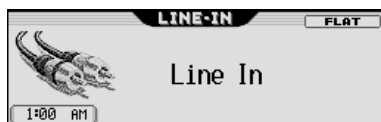

EXT-IN: For selecting the external component connected to the CD changer jack.

2 Turn on the connected component and start playing the source.

3 Adjust the volume.

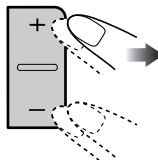

4 Adjust the sound as you want. (See pages 21 – 24.)

# SIRIUS® radio operations

## About SIRIUS radio

SIRIUS is a satellite radio that can deliver digital-quality sound.

SIRIUS has 65 music channels which are all commercial-free and 50 channels of sports, news, and entertainment programs.

You can enjoy and control the SIRIUS radio digital entertainment channels from the receiver by connecting the JVC SIRIUS radio DLP—Down Link Processor (optionally purchased) to the CD changer jack on the rear.

- You can also connect the JVC SIRIUS radio PnP (Plug and Play), KT-SR1000 or KT-SR2000, using the JVC SIRIUS radio adapter, KS-U100K (not supplied). By turning on the power of the receiver, you can turn on/off the JVC PnP. However, you cannot control it from this receiver.

### GCI (Global Control Information) update:

- If channels are updated after subscription, updating starts automatically. “Channels Updating XX%\* Completed” appears and no sound can be heard.
- Update takes a few minutes to complete.
- Do not press any button or perform any operation until updating has been completed.

Before operating your SIRIUS radio:

- For connection, see Installation/ Connection Manual (separate volume).
- Refer also to the Instructions supplied with your SIRIUS radio.

\* Changes every 20% of update is completed, (ex. 20%, 40%, 60%).

Before you can listen to JVC DLP, activate your SIRIUS subscription after connection:

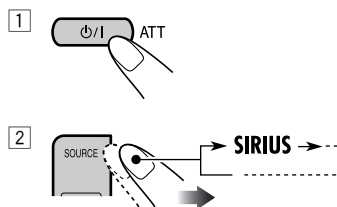

JVC DLP starts updating all the SIRIUS channels. (See GCI update on the left column.)

Once completed, JVC DLP tunes in to the preset channel, CH184.

- 3 Check your Sirius ID, see page 32.
- 4 Contact SIRIUS on the internet at <http://activate.siriusradio.com/> to activate your subscription, or you can call SIRIUS toll-free at 1-888-539-SIRIUS (7474). “Subscription Updated Press Any Key to Continue” appears on the display once subscription has been completed.



# Listening to the SIRIUS® radio

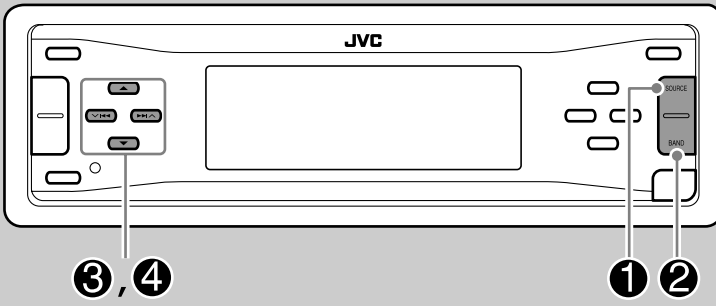

1

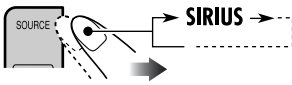

2



\*

\* Signal strength bar increases as the receiving signal improves. If no signal is received, it disappears.

3

Select a category.

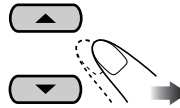

You can tune in to all the channels of every category by selecting “ALL.” Selecting a particular category (SPORTS, ENTERTAINMENT, etc.) allows you to enjoy only the channels from the selected category.

- Holding these buttons can display the category list (see page 43).

4

Select a channel for listening.

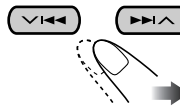

Holding these buttons changes the channels rapidly.

- When changing the category or channel, invalid and unsubscribed channels are skipped automatically.



## Selecting a category/channel on the list

1 Enter the MODE Menu (see page 5).

2 To select a category.

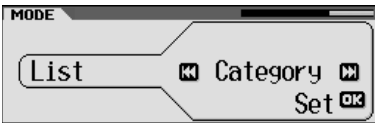
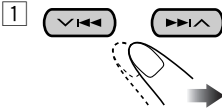

You can move to the other lists by pressing  $\leftarrow/\rightarrow$  ( $\blacktriangle/\blacktriangledown$ ).

The first channel of the selected category is tuned in.

- If you select the current category (highlighted on the display), its Channel List appears.
- Holding  $\blacktriangle/\blacktriangledown$  can also show the category list while listening to a channel.

To select a channel.

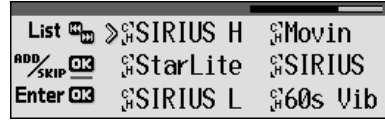
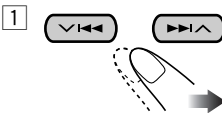

You can move to the other lists by pressing  $\leftarrow/\rightarrow$  ( $\blacktriangle/\blacktriangledown$ ).

## Selecting your favorite from the list

While displaying the channel list or preset list (see page 42 and left column)...

1 Enter the list information mode.



You will hear a beep sound before proceeding.

2

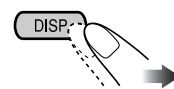

If no operation is done within 5 seconds, list information mode is canceled.

Channel list (Channel name)

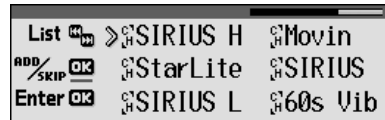

Channel list (Artist name)

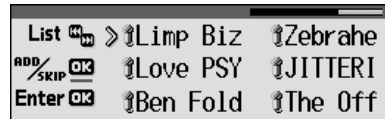

Channel list (Song title)

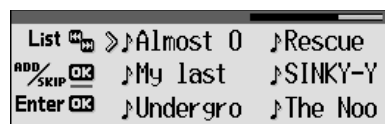

To be continued....

**3 Select an item.**

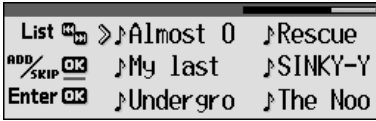
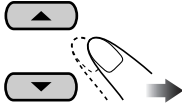

Ex.: To select a favorite song

- You can move to the other lists by pressing **◀◀/▶▶**.

**■ Skipping channels**

While displaying the channel list (see pages 42 and 43)....

Ex.: To skip listed item 6

\* *You cannot skip the preset channel, CH184.*

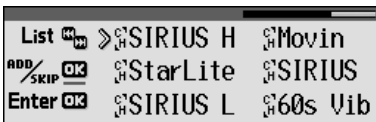
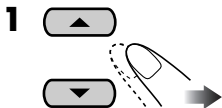

**2 Select a channel you want to skip.**

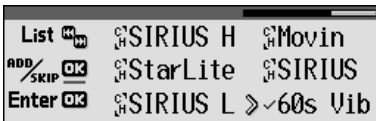

- You can move to the other lists by pressing **◀◀/▶▶**.

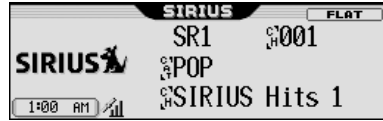
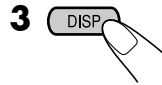

Listed item 6 will be skipped when you press **◀◀/▶▶** or **▲/▼** to search for a channel.

- The skipped channel (in this example, item 6) cannot be selected from the channel list.
- If all channels in a category are skipped, the category will also be skipped.

**To add (restore) skipped channels,** repeat the same procedure.

**To add (restore) all skipped channel in a category,** select "ALL" category before performing the above procedure.

**To change the display information while**

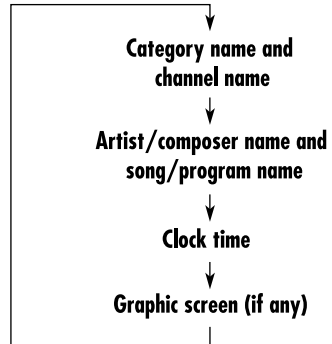
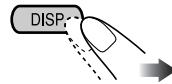

# Maintenance

## How to clean the connectors

Frequent detachment will deteriorate the connectors.

To minimize this possibility, periodically wipe the connectors with a cotton swab or cloth moistened with alcohol, being careful not to damage the connectors.

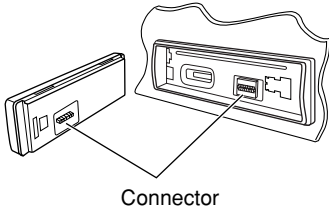

## Moisture condensation

Moisture may condense on the lens inside the CD player in the following cases:

- After starting the heater in the car.
- If it becomes very humid inside the car.

Should this occur, the CD player may malfunction. In this case, eject the disc and leave the receiver turned on for a few hours until the moisture evaporates.

## How to handle discs/SD card

**When removing a disc from its case,** press down the center holder of the case and lift the disc out, holding it by the edges.

Center holder



- Always hold the disc by the edges. Do not touch its recording surface.

**When storing a disc into its case,** gently insert the disc around the center holder (with the printed surface facing up).

- Make sure to store discs into the cases after use.

SD cards are precision products. **DO NOT** impact, bend, drop, or wet them.

## To keep discs clean

A dirty disc may not play correctly. If a disc does become dirty, wipe it with a soft cloth in a straight line from center to edge.



- Do not use any solvent (for example, conventional record cleaner, spray, thinner, benzene, etc.) to clean discs.

## To play new discs

New discs may have some rough spots around the inner and outer edges. If such a disc is used, this receiver may reject the disc.



To remove these rough spots, rub the edges with a pencil or ball-point pen, etc.

## Available character

Capital letters

A	B	C	D	E	F	G	H	I	J	K	L	M	N
O	P	Q	R	S	T	U	V	W	X	Y	Z	space	

Small letters

a	b	c	d	e	f	g	h	i	j	k	l	m	n
o	p	q	r	s	t	u	v	w	x	y	z	space	

Numbers and symbols

0	1	2	3	4	5	6	7	8	9	!	"	#	\$
%	&	'	(	)	*	+	,	-	.	/	:	;	<
=	>	?	@	_	`	space							

## Do not use the following discs:



# More about this receiver

## Basic operations

### Turning on the power

- By pressing SOURCE on the receiver, you can also turn on the power.

### Turning off the power

- If you turn off the power while listening to a disc, disc play will start from where playback has been stopped previously, next time you turn on the power.

### Selecting the source

- When no disc or SD card is loaded in the receiver, “CD” or “SD” cannot be selected.
- Without connecting to the SIRIUS radio or CD changer, “SIRIUS” or “CD-CH” cannot be selected.
- To select the “EXT-IN” for the playback source, set the “Ext Input” setting correctly (see page 32).

## Tuner operations

### Storing stations in memory

- During SSM search...
  - All previously stored stations are erased and stations are stored newly.
  - Received stations are preset in No. 1 (lowest frequency) to No. 6 (highest frequency).
  - When SSM is over, the station stored in No. 1 will be automatically tuned in.
- When storing a station manually, a previously preset station is erased when a new station is stored in the same preset number.

## Disc/SD card operations

### Caution for DualDisc playback

- The Non-DVD side of a “DualDisc” does not comply with the “Compact Disc Digital Audio” standard. Therefore, the use of Non-DVD side of a DualDisc on this product may not be recommended.

## General

- This receiver has been designed to reproduce CDs/CD Texts, and CD-Rs (Recordable)/CD-RWs (Rewritable) in audio CD (CD-DA), MP3 and WMA format and MP3/WMA files recorded in an SD card.
- When a disc or an SD card has been loaded, selecting “CD” or “SD” for the playback source starts playback.
- When a track or folder whose number is greater than 99 is selected, the icon before the number (📀, 📁) goes off (to show its assigned 3-digits number).

### Inserting a disc

- When a disc is inserted upside down, the control panel moves down, and the disc automatically ejects from the loading slot.
- If you keep the control panel open for about 1 minute, (beep sound when the “Beep” setting is turned “On”—see page 32) the control panel returns to its previous position.
- Do not insert 8 cm (3-3/16”) discs (single CD) and unusual shape discs (heart, flower, etc.) into the loading slot.

### Playing a disc/SD card

- While playing an audio CD: If a title has been assigned to the audio CD (see page 37), it will be shown on the display.
- While fast-forwarding or reversing an MP3 or WMA track, you can only hear intermittent sounds.
- While playing an SD card, the playback order may differ from other SD players.
- This receiver may be unable to play back some SD card due to their characteristics or recording conditions.
- This receiver cannot play back mini SD card and MMC.
- If the inserted SD card does not have the correct files, “SD” is skipped.

### Playing a CD-R or CD-RW

- Use only “finalized” CD-Rs or CD-RWs.
- This receiver can play back only the files of the same type which is first detected if a disc includes both audio CD (CD-DA) files and MP3/WMA files.

- This receiver can play back multi-session discs; however, unclosed sessions will be skipped while playing.
- Some CD-Rs or CD-RWs may not play back on this receiver because of their disc characteristics, and for the following causes:
  - Discs are dirty or scratched.
  - Moisture condensation occurs on the lens inside the receiver.
  - The pickup lens inside the receiver is dirty.
  - CD-R/CD-RW on which the files are written with “Packet Write” method.
  - Improper recording conditions (missing data, etc.) or media conditions (stain, scratch, warp, etc.).
- CD-RWs may require a longer readout time since the reflectance of CD-RWs is lower than that of regular CDs.
- Do not use the following CD-Rs or CD-RWs:
  - Discs with stickers, labels, or protective seal stuck to the surface.
  - Discs on which labels can be directly printed by an ink jet printer.
 Using these discs under high temperatures or high humidities may cause malfunctions or damages to discs.
- For MP3/WMA discs:
 

The maximum number of characters for file/folder names vary among the disc format used (includes 4 extension characters—<.mp3> or <.wma>).

  - ISO 9660 Level 1: up to 12 characters
  - ISO 9660 Level 2: up to 31 characters
  - Romeo\*: up to 128 (72) characters
  - Joliet\*: up to 64 (36) characters
  - Windows long file name\*: up to 128 (72) characters

\* *The parenthesis figure is the maximum number of characters for file/folder names in case the total number of files and folders is 313 or more.*
- For SD cards:
 

The maximum number of characters for folder name is 8 characters; file name is 12 characters.

The receiver cannot recognize folder with period (.) on the folder name.
- This receiver can recognize the total of 512 files, of 200 folders, and of 8 hierarchies of an MP3/WMA disc; 255 files and 63 folders of an SD card.
- This receiver can play back the files recorded in VBR (variable bit rate).
 

The files recorded in VBR have a discrepancy in elapsed time display, and do not show the actual elapsed time. Especially, after performing the search function, this difference becomes noticeable.

### **Playing an MP3/WMA track**

- This receiver can play back MP3/WMA files with the extension code <.mp3> or <.wma> (regardless of the letter case—upper/lower).
- This receiver can show the names of albums, artists (performer), and ID3 Tag (Version 1.0, 1.1, 2.2, 2.3, or 2.4) for MP3 files and for WMA files.
- This receiver can display only one-byte characters. No other characters can be correctly displayed (see page 45).
- This receiver can play back MP3/WMA files meeting the conditions below:
  - Bit rate: 8 kbps — 320 kbps
  - Sampling frequency:
    - 48 kHz, 44.1 kHz, 32 kHz (for MPEG-1)
    - 24 kHz, 22.05 kHz, 16 kHz (for MPEG-2)
    - 48 kHz, 44.1 kHz, 32 kHz (for WMA)
  - Disc format: ISO 9660 Level 1/Level 2, Romeo, Joliet, Windows long file name
- The search function works but search speed is not constant.

*To be continued...*

## **Changing the source**

- If you change the source, playback also stops (without ejecting the disc). Next time you select “CD,” “SD,” or “CD-CH” for the playback source, playback starts from where it has been stopped previously.

## **Image Link**

- Image Link will not work in the following cases:
  - If no <jll> file is included in an MP3/WMA folder.
  - If Intro play is activated.
  - If the source is changed to another from “CD” or “SD.”
  - If more than one <jll> file are included in a folder, a file with the youngest file number is used for the graphic screen.

## **Ejecting a disc**

- If the ejected disc is not removed within 15 seconds, the disc is automatically inserted again into the loading slot to prevent it from dust. (Disc will not play this time.)

## **Sound adjustment**

### **General**

- If you are using a two-speaker system, set the fader level to the center.
- Subwoofer out setting takes effect only when a subwoofer is connected.
- You cannot change the input level—VolAdjust of the FM stations. If the source is FM, “Fix” will appear when you try to adjust it.

## **Graphic display**

### **Downloading (or deleting) files**

- You can download a file only while selecting “CD” or “SD” for the playback source; on the other hand, you can delete a file while selecting any source.
- If you have already downloaded an animation for “Opening,” “Ending,” or “Movie,” downloading a new animation deletes the previously stored animation.

- It takes a long time to download an animation.
  - About 3 to 4 seconds for a still image (one frame).
  - About 1 to 2 minutes for an animation of 30 frames.
  - About 4 minutes for an animation of 90 frames.
- If a disc inserted does not include any <jll> and <jla> files, beeps sound when you try to operate the downloading procedure.
- If you try to store a 31st image for picture screen, “Picture Full” appears and you cannot start downloading. Delete unwanted files before downloading.
- If the total frame number of an animation downloaded exceeds the following number, the frames exceeding that numbers are ignored.
  - For “Opening” and “Ending”: 30
  - For “Movie”: 90

## **General settings—PSM**

- “Auto Dimmer” may not work correctly on some vehicles, particularly on those having a control dial for dimming. In this case, change the “Dimmer” setting to any one other than “Auto.”
- If “LCD Type” is set to “Auto,” the display pattern will change to the “Positive” or “Negative” pattern depending on the “Dimmer” setting.
- If you change the “Amp Gain” setting from “High PWR” to “Low PWR” while the volume level is set higher than “Volume 30,” the receiver automatically changes the volume level to “Volume 30.”

## **Other main functions**

### **Assigning titles to the sources**

- If you try to assign a title to a 31st disc or a 31st station frequency, “Name Full” appears and you cannot enter the text entry mode. Delete unwanted titles before assignment.
- Titles assigned to discs in the CD changer can also be shown if you playback the disc from the receiver.



# Troubleshooting

What appears to be trouble is not always serious. Check the following points before calling a service center.

	Symptoms	Causes	Remedies
General	<ul style="list-style-type: none"> <li>• Sound cannot be heard from the speakers.</li> </ul>	<p>The volume level is set to the minimum level.</p> <p>Connections are incorrect.</p>	<p>Adjust it to the optimum level.</p> <p>Check the cords and connections.</p>
	<ul style="list-style-type: none"> <li>• The receiver does not work at all.</li> </ul>	<p>The built-in microcomputer may have functioned incorrectly due to noise, etc.</p>	<p>Reset the receiver (see page 2).</p>
	<ul style="list-style-type: none"> <li>• “Connect Error” appears on the display.</li> </ul>	<p>The control panel is not attached correctly.</p>	<p>Remove the control panel, wipe the connector, then attach it again (see pages 38 and 45).</p>
	<ul style="list-style-type: none"> <li>• “Push Reset” appears on the display and the control panel movement is frozen.</li> </ul>	<p>Something is blocking the control panel movement.</p>	<p>Reset the receiver (see page 2). If this does not work, check the installation.</p>
FM/AM	<ul style="list-style-type: none"> <li>• SSM automatic presetting does not work.</li> </ul>	<p>Signals are too weak.</p>	<p>Store stations manually.</p>
	<ul style="list-style-type: none"> <li>• Static noise while listening to the radio.</li> </ul>	<p>The antenna is not connected firmly.</p>	<p>Connect the antenna firmly.</p>
Disc playback	<ul style="list-style-type: none"> <li>• CD-R/CD-RW cannot be played back.</li> <li>• Tracks on the CD-R/CD-RW cannot be skipped.</li> </ul>	<p>CD-R/CD-RW is not finalized.</p>	<ul style="list-style-type: none"> <li>• Insert a finalized CD-R/CD-RW.</li> <li>• Finalize the CD-R/CD-RW with the component which you used for recording.</li> </ul>
	<ul style="list-style-type: none"> <li>• Disc cannot be ejected.</li> </ul>	<p>Disc is locked.</p>	<p>Unlock the disc (see page 19).</p>
	<ul style="list-style-type: none"> <li>• Disc cannot be recognized (“No Disc,” “Loading Error,” or “Eject Error” flashes).</li> </ul>	<p>The CD player may have functioned incorrectly.</p>	<p>Eject the disc forcibly (see page 4).</p>
	<ul style="list-style-type: none"> <li>• Disc sound is sometimes interrupted.</li> </ul>	<p>You are driving on rough roads.</p> <p>Disc is scratched.</p> <p>Connections are incorrect.</p>	<p>Stop playback while driving on rough roads.</p> <p>Change the disc.</p> <p>Check the cords and connections.</p>

To be continued....

	Symptoms	Causes	Remedies
MP3/WMA disc/SD card playback	<ul style="list-style-type: none"> <li>• “No Files” appears for a while, then the disc ejects.</li> </ul>	No MP3/WMA tracks are recorded.	Change the disc or the SD card.
		MP3/WMA tracks do not have the extension code <.mp3> or <.wma> in their file names.	Add the extension code <.mp3> or <.wma> to their file names.
		MP3/WMA tracks are not recorded in the format compliant with ISO 9660 Level 1, Level 2, Romeo, or Joliet.	Change the disc or the SD card. (Record MP3/WMA tracks using a compliant application.)
	<ul style="list-style-type: none"> <li>• Noise is generated.</li> </ul>	The track played back is not an MP3/WMA track (although it has the extension code <.mp3> or <.wma>).	Skip to another track or change the disc or the SD card. (Do not add the extension code <.mp3> or <.wma> to non-MP3 or WMA tracks.)
	<ul style="list-style-type: none"> <li>• Elapsed playing time is not correct.</li> </ul>	This sometimes occurs during play. This is caused by how the tracks are recorded.	_____
	<ul style="list-style-type: none"> <li>• “Not Support” appears on the display and track skips.</li> </ul>	<ul style="list-style-type: none"> <li>• Tracks are not encoded in an appropriate format.</li> <li>• Copy-protected WMA tracks cannot be played back.</li> </ul>	Skip to the next track.
	<ul style="list-style-type: none"> <li>• “No Music” appears on the display.</li> </ul>	<ul style="list-style-type: none"> <li>• No MP3/WMA tracks are recorded on the disc.</li> <li>• Only &lt;jll&gt; and/or &lt;jla&gt; files are recorded on the disc.</li> </ul>	Change the disc or the SD card.
	<ul style="list-style-type: none"> <li>• “SD Loading Error” appears on the display.</li> </ul>	SD card is not inserted correctly.	Detach the control panel and reinsert the SD card. The control panel goes back to Angle 1. (See pages 15 and 38.)
	<ul style="list-style-type: none"> <li>• “Read Failed” appears on the display.</li> </ul>	Tracks are not encoded in an appropriate format.	Use SD card formatted in FAT 12/16.
The SD card or tracks cannot be played back.		Change the SD card.	
<ul style="list-style-type: none"> <li>• Correct characters are not displayed (ex. album name).</li> </ul>	This receiver can only display alphabets (capital: A – Z, small: a – z), numbers, and a limited number of symbols (see page 45).	_____	

	Symptoms	Causes	Remedies
Graphics	<ul style="list-style-type: none"> <li>Download does not seem to finish.</li> </ul>	It takes quite a long time to download an animation of many frames (see page 48).	_____
	<ul style="list-style-type: none"> <li>Opening and ending animation does not appear.</li> </ul>	“KeyIn CFM” is set to “Off.”	Select “On” (see page 30).
	<ul style="list-style-type: none"> <li>Animation does not move.</li> </ul>	Temperature inside the car is below 0°C (32°F)— <b>LOWTEMP</b> appears on the display.	Wait until the operating temperature resumes.
	<ul style="list-style-type: none"> <li>The entire animation has not been downloaded.</li> </ul>	“Opening” and “Ending” can only memorize 30 frames of the animation even it includes 90 frames.	_____
Preferred setting modes—PSM	<ul style="list-style-type: none"> <li>The display graphic function does not work correctly.</li> </ul>	Temperature inside the car is below 0°C (32°F)— <b>LOWTEMP</b> appears on the display.	Wait until the operating temperature resumes.
	<ul style="list-style-type: none"> <li>You cannot select an image or animation for “Pict” (“No Picture,” “No Movie,” or “No Slide,” is shown as the selectable item).</li> </ul>	No files are downloaded yet.	Select an image only after downloading the appropriate files in memory.
CD changer	<ul style="list-style-type: none"> <li>“No Magazine” flashes on the display.</li> </ul>	No magazine is loaded in the CD changer.	Insert the magazine.
	<ul style="list-style-type: none"> <li>“No Disc” flashes on the display.</li> </ul>	No disc is in the magazine.	Insert disc into the magazine.
		Disc is inserted upside down.	Insert disc correctly.
	<ul style="list-style-type: none"> <li>“Reset 08” flashes on the display.</li> </ul>	This receiver is not connected to the CD changer correctly.	Connect this receiver and the CD changer correctly and press the reset button of the CD changer.
	<ul style="list-style-type: none"> <li>“Reset 01” – “Reset 07” flashes on the display.</li> </ul>	The CD player may have functioned incorrectly.	Press the reset button of the CD changer.
<ul style="list-style-type: none"> <li>The CD changer does not work at all.</li> </ul>	The built-in microcomputer may function incorrectly due to noise, etc.	Reset the receiver (see page 2).	

To be continued....

	Symptoms	Causes	Remedies
SIRIUS	• “CALL 1-888-539-SIRIUS TO SUBSCRIBE” scrolls on the display.	Subscription has not been done.	Starts subscribing (see page 40).
	• “No Signal” appears on the display	Signals are too weak.	Move to an area with stronger signals.
	• “No Antenna” appears on the display.	The antenna is not connected firmly.	Connect the antenna firmly.
	• “Invalid Channel” appears on the display for about 5 seconds, then returns to the previous display.	No broadcast on the selected channel.	Select another channel or continue listening to the previous channel.
	• “Skipped Channel” appears when presetting a channel.	The channel is set to be skipped.	Add the channel again (see page 44).
	• “No name” appears or scrolls on the display.	No text information for the selected channel.	—————
	• No sound can be heard.	“Channels Updating XX%* Completed” appears on the display.	The receiver is updating the channel information and it takes a few minutes to complete.
	• SIRIUS radio does not work at all.	The built-in microcomputer may function incorrectly due to noise, etc.	Reconnect the SIRIUS radio after a few seconds.

\* Changes every 20% of update is completed, (ex. 20%, 40%, 60%).

- Microsoft and Windows Media are either registered trademarks or trademarks of Microsoft Corporation in the United States and/or other countries.
- SD logo is a trademark.

# Specifications

## AUDIO AMPLIFIER SECTION

Power Output:  
20 W RMS  $\times$  4 Channels at 4  $\Omega$   
and  $\leq$  1% THD+N  
Signal to Noise Ratio:  
80 dBA (reference: 1 W into 4  $\Omega$ )



Load Impedance: 4  $\Omega$  (4  $\Omega$  to 8  $\Omega$  allowance)  
Equalizer Control Range:  
Low:  $\pm$ 12 dB (60 Hz, 80 Hz, 100 Hz, 120 Hz)  
Mid:  $\pm$ 12 dB (Fix)  
High:  $\pm$ 12 dB (8 kHz, 10 kHz, 12 kHz, 15 kHz)  
Frequency Response: 40 Hz to 20 000 Hz  
Line-In Level/Impedance:  
KD-AR960: 1.5 V/20 k $\Omega$  load  
Line-Out Level/Impedance:  
KD-AR960: 5.0 V/20 k $\Omega$  load (full scale)  
KD-LH910: 4.0 V/20 k $\Omega$  load (full scale)  
Output Impedance: 1 k $\Omega$   
Subwoofer-Out Level/Impedance:  
2.0 V/20 k $\Omega$  load (full scale)  
Other Terminals:  
CD changer, LINE IN (for KD-AR960)

## TUNER SECTION

Frequency Range:  
FM: 87.5 MHz to 107.9 MHz  
(with channel interval set to 200 kHz)  
87.5 MHz to 108.0 MHz  
(with channel interval set to 50 kHz)  
AM: 530 kHz to 1 710 kHz  
(with channel interval set to 10 kHz)  
531 kHz to 1 602 kHz  
(with channel interval set to 9 kHz)

### [FM Tuner]

Usable Sensitivity: 11.3 dBf (1.0  $\mu$ V/75  $\Omega$ )  
50 dB Quieting Sensitivity: 16.3 dBf (1.8  $\mu$ V/75  $\Omega$ )  
Alternate Channel Selectivity (400 kHz): 65 dB  
Frequency Response: 40 Hz to 15 000 Hz  
Stereo Separation: 35 dB  
Capture Ratio: 1.5 dB

### [AM Tuner]

Sensitivity: 20  $\mu$ V  
Selectivity: 35 dB

## CD/SD PLAYER SECTION

Type: Compact disc player  
Signal Detection System: Non-contact optical pickup (semiconductor laser)  
Number of Channels: 2 channels (stereo)  
Frequency Response: 5 Hz to 20 000 Hz  
Dynamic Range: 96 dB  
Signal-to-Noise Ratio: 98 dB  
Wow and Flutter: Less than measurable limit  
MP3 (MPEG1/2 Audio Layer 3):  
Max. Bit Rate: 320 kbps  
WMA (Windows Media<sup>®</sup> Audio):  
Max. Bit Rate: 192 kbps  
Playable SD Card: Format: Fat 12/16  
Storage: Up to 512 MB  
Playable Audio Format for SD Card:  
MP3/WMA

## GENERAL

Power Requirement:  
Operating Voltage:  
DC 14.4 V (11 V to 16 V allowance)  
Grounding System: Negative ground  
Allowable Operating Temperature:  
0°C to +40°C (32°F to 104°F)  
Dimensions (W  $\times$  H  $\times$  D):  
Installation Size (approx.):  
182 mm  $\times$  52 mm  $\times$  159 mm  
(7-3/16"  $\times$  2-1/16"  $\times$  6-5/16")  
Panel Size (approx.):  
188 mm  $\times$  58 mm  $\times$  12 mm  
(7-7/16"  $\times$  2-5/16"  $\times$  1/2")  
Mass (approx.):  
1.7 kg (3.8 lbs) (excluding accessories)

*Design and specifications are subject to change without notice.*

If a kit is necessary for your car, consult your telephone directory for the nearest car audio speciality shop.



**Having TROUBLE with operation?**

**Please reset your unit**

Refer to page of How to reset your unit

**Still having trouble??**

USA ONLY

**Call 1-800-252-5722**

**<http://www.jvc.com>**

**We can help you!**

**JVC**



EN, SP, FR

© 2004 Victor Company of Japan, Limited

1204DTSMDTJEIN

# JVC KD-AR960/KD-LH910 KD-AR860/KD-LH810

## Installation/Connection Manual Manual de instalación/conexión Manuel d'installation/raccordement

GET0271-002A  
[J]

1204DTSMDTJEIN  
EN, SP, FR

### ENGLISH

This receiver is designed to operate on **12 V DC, NEGATIVE ground electrical systems**. If your vehicle does not have this system, a voltage inverter is required, which can be purchased at JVC car audio dealers.

### ESPAÑOL

Esta unidad está diseñada para funcionar con **12 V de CC, con sistemas eléctricos de masa NEGATIVA**. Si su vehículo no posee este sistema, será necesario un inversor de tensión, que puede ser adquirido en los concesionarios de JVC de equipos de audio para automóviles.

### FRANÇAIS

Cet appareil est conçu pour fonctionner sur des sources de courant continu de **12 V à masse NEGATIVE**. Si votre véhicule n'offre pas ce type d'alimentation, il vous faut un convertisseur de tension, que vous pouvez acheter chez un revendeur d'autoradios JVC.

#### Parts list for installation and connection

The following parts are provided for this receiver. After checking them, please set them correctly.

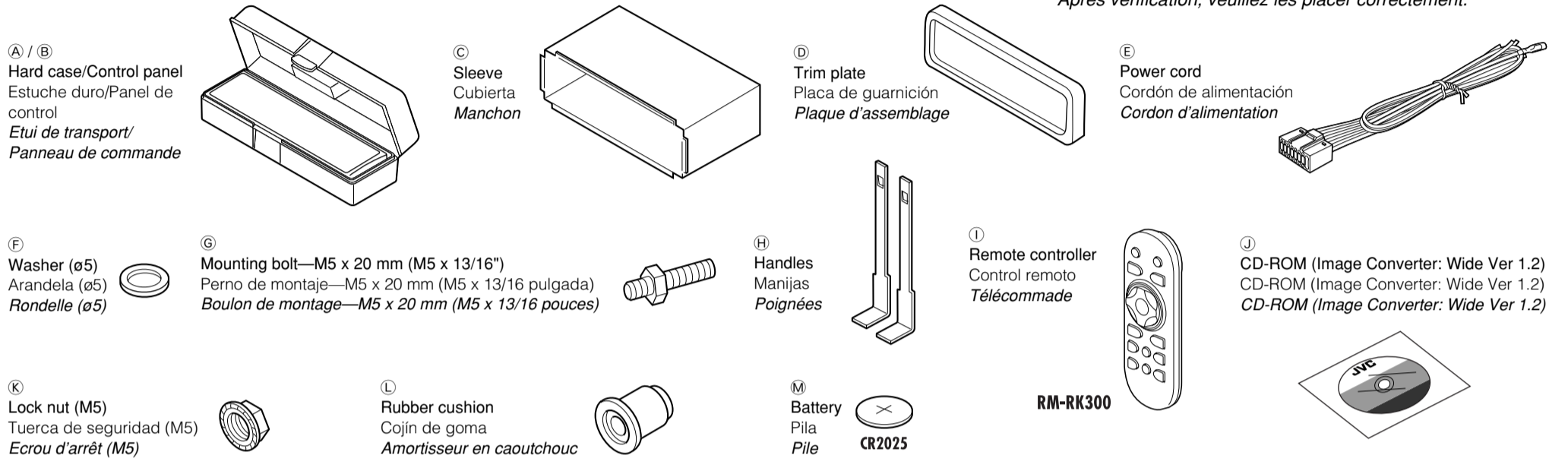

### INSTALLATION (IN-DASH MOUNTING)

The following illustration shows a typical installation. If you have any questions or require information regarding installation kits, consult your JVC car audio dealer or a company supplying kits.

• If you are not sure how to install this receiver correctly, have it installed by a qualified technician.

### INSTALACION (MONTAJE EN EL TABLERO DE INSTRUMENTOS)

La siguiente ilustración muestra una instalación típica. Si tiene alguna pregunta o necesita información acerca de las herramientas para instalación, consulte con su concesionario de JVC de equipos de audio para automóviles o a una compañía que suministra tales herramientas.

• Si usted no está seguro de cómo instalar correctamente la unidad, hágala instalar por un técnico cualificado.

### INSTALLATION (MONTAGE DANS LE TABLEAU DE BORD)

L'illustration suivante est un exemple d'installation typique. Si vous avez des questions ou avez besoin d'information sur des kits d'installation, consultez votre revendeur d'autoradios JVC ou une compagnie d'approvisionnement.

• Si l'on n'est pas sûr de pouvoir installer correctement cet appareil, le faire installer par un technicien qualifié.

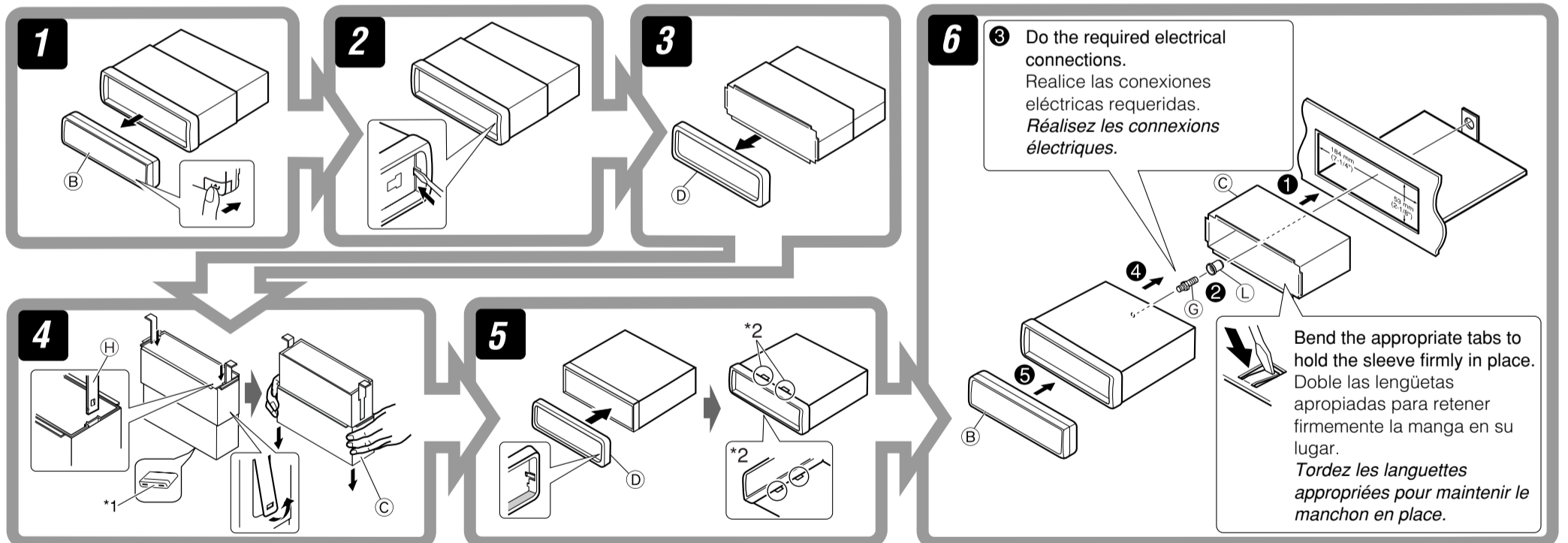

\*1 When you stand the receiver, be careful not to damage the fuse on the rear.

\*1 Al poner la unidad vertical, tenga cuidado de no dañar el fusible provisto en la parte posterior.

\*1 Lorsque vous mettez l'appareil à la verticale, faire attention de ne pas endommager le fusible situé sur l'arrière.

\*2 Fit the protrusions outside the receiver.

\*2 Haga encajar los salientes del exterior de la unidad.

\*2 Fixez les protubérances à l'extérieur de l'appareil.

#### Removing the receiver

Before removing the receiver, release the rear section.

#### Extracción de la unidad

Antes de extraer la unidad, libere la sección trasera.

#### Retrait de l'appareil

Avant de retirer l'appareil, libérer la section arrière.

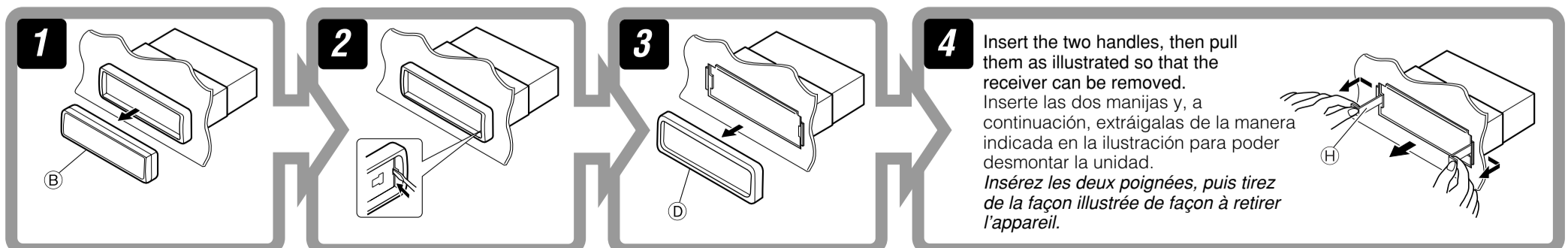

**When using the optional stay / Cuando emplea un soporte opcional / Lors de l'utilisation du hauban en option**

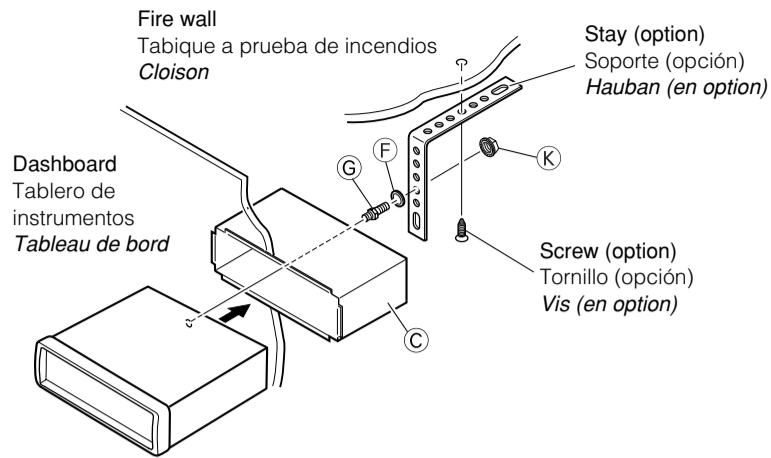

Install the receiver at an angle of less than 30°. Instale la unidad a un ángulo de menos de 30°. Installez l'appareil avec un angle de moins de 30°.

**When installing the receiver without using the sleeve / Instalación de la unidad sin utilizar la cubierta / Lors de l'installation de l'appareil sans utiliser de manchon**

In a Toyota for example, first remove the car radio and install the receiver in its place. En un Toyota por ejemplo, primero retire la radio del automóvil y luego instale la unidad en su lugar. Par exemple dans une Toyota, retirer d'abord l'autoradio et installer l'appareil à la place.

Flat type screws—M5 x 8 mm (M5 x 3/8")\*<sup>3</sup>  
Tornillos tipo plano—M5 x 8 mm (M5 x 3/8 pulgada)\*<sup>3</sup>  
Vis à tête plate—M5 x 8 mm (M5 x 3/8 pouces)\*<sup>3</sup>

Pocket / Compartimiento / Poche

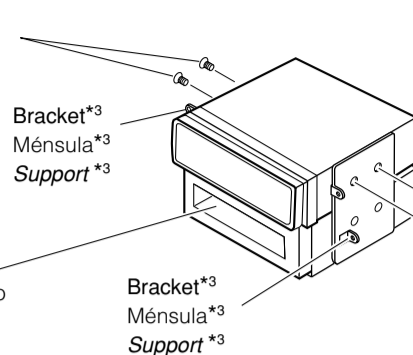

\*<sup>3</sup> Not included for this receiver.  
\*<sup>3</sup> No suministrado con esta unidad.  
\*<sup>3</sup> Non fourni avec cet appareil.

Flat type screws—M5 x 8 mm (M5 x 3/8")\*<sup>3</sup>  
Tornillos tipo plano—M5 x 8 mm (M5 x 3/8 pulgada)\*<sup>3</sup>  
Vis à tête plate—M5 x 8 mm (M5 x 3/8 pouces)\*<sup>3</sup>

- Note** : When installing the receiver on the mounting bracket, make sure to use the 8 mm (3/8")-long screws. If longer screws are used, they could damage the receiver.  
**Nota** : Cuando instala la unidad en la ménsula de montaje, asegúrese de utilizar los tornillos de 8 mm (3/8 pulgada) de longitud. Si se utilizan tornillos más largos, éstos pueden dañar la unidad.  
**Remarque** : Lors de l'installation de l'appareil sur le support de montage, s'assurer d'utiliser des vis d'une longueur de 8 mm (3/8 pouces). Si des vis plus longues sont utilisées, elles peuvent endommager l'appareil.

**Caution when installing / Precaución en la instalación / Précautions lors de l'installation**

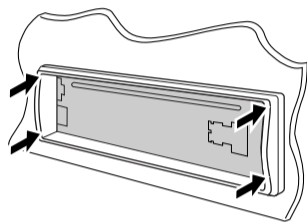

- Fit the receiver into the mounting sleeve by using four corners of the trim plate.  
• DO NOT press the panel (shaded in the illustration). Introduzca el receptor en la manga de montaje utilizando las cuatro esquinas de la placa decorativa.  
• NO presione el panel (sombreado en la ilustración).  
Fixez l'autoradio sur le manchon de montage en utilisant les quatre coins de la plaque de garniture.  
• NE PUSSEZ PAS sur le panneau (en gris sur l'illustration).

**ELECTRICAL CONNECTIONS**

To prevent short circuits, we recommend that you disconnect the battery's negative terminal and make all electrical connections before installing the receiver.

- Be sure to ground this receiver to the car's chassis again after installation.

**Notes:**

- Replace the fuse with one of the specified rating. If the fuse blows frequently, consult your JVC car audio dealer.
- It is recommended to connect to the speakers with maximum power of more than 50 W (both at the rear and at the front, with an impedance of 4 Ω to 8 Ω). If the maximum power is less than 50 W, change "Amp Gain" setting to prevent the speakers from being damaged. For KD-AR960/KD-LH910: see page 33; For KD-AR860/KD-LH810: see page 31 of the INSTRUCTIONS.
- To prevent short-circuit, cover the terminals of the UNUSED leads with insulating tape.
- The heat sink becomes very hot after use. Be careful not to touch it when removing this receiver.

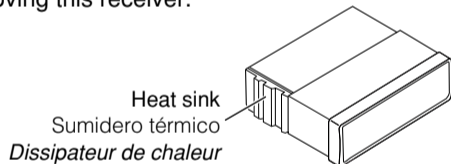

**CONEXIONES ELECTRICAS**

Para evitar cortocircuitos, recomendamos que desconecte el terminal negativo de la batería y que efectúe todas las conexiones eléctricas antes de instalar la unidad.

- Asegúrese de volver a conectar a masa esta unidad al chasis del automóvil después de la instalación.

**Notas:**

- Reemplace el fusible por uno con la corriente especificada. Si el fusible se quemase frecuentemente consulte con su concesionario de JVC de equipos de audio para automóviles.
- Se recomienda conectar los altavoces con una potencia máxima de más de 50 W (tanto atrás como adelante, con una impedancia de 4 Ω a 8 Ω). Si la potencia máxima es de menos de 50 W, cambie el ajuste "Amp Gain" para evitar daños en los altavoces. Para KD-AR960/KD-LH910: consulte la página 33; para KD-AR860/KD-LH810: consulte la página 31 del MANUAL DE INSTRUCCIONES.
- Para evitar cortocircuitos, cubra los cables NO UTILIZADOS con cinta aislante.
- El sumidero térmico estará muy caliente después del uso. Asegúrese de no tocarlo al desmontar esta unidad.

**RACCORDEMENTS ELECTRIQUES**

Pour éviter tout court-circuit, nous vous recommandons de débrancher la borne négative de la batterie et d'effectuer tous les raccordements électriques avant d'installer l'appareil.

- Assurez-vous de raccorder de nouveau la mise à la masse de cet appareil au châssis de la voiture après l'installation.

**Remarques:**

- Remplacer le fusible par un de la valeur précisée. Si le fusible saute souvent, consulter votre revendeur d'autoradios JVC.
- Il est recommandé de connecter des enceintes avec une puissance de plus de 50 W (les enceintes arrière et les enceintes avant, avec une impédance comprise entre 4 Ω et 8 Ω). Si la puissance maximum est inférieure à 50 W, changez le réglage "Amp Gain" pour éviter que les enceintes soient endommagées. Pour le KD-AR960/KD-LH910: référez-vous à la page 33; pour le KD-AR860/KD-LH810: référez-vous à la page 31 du MANUEL D'INSTRUCTIONS.
- Pour éviter les court-circuits, couvrir les bornes des fils qui ne sont PAS UTILISÉS avec de la bande isolante.
- Le dissipateur de chaleur devient très chaud après usage. Faire attention de ne pas le toucher en retirant cet appareil.

**PRECAUTIONS on power supply and speaker connections:**

- DO NOT connect the speaker leads of the power cord to the car battery; otherwise, the receiver will be seriously damaged.
- BEFORE connecting the speaker leads of the power cord to the speakers, check the speaker wiring in your car.

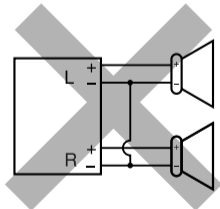

**PRECAUCIONES sobre las conexiones de la fuente de alimentación y de los altavoces:**

- NO conecte los conductores de altavoz del cable de alimentación a la batería de automóvil, pues podrían producirse graves daños en la unidad.
- ANTES de conectar a los altavoces los conductores de altavoz del cable de alimentación, verifique el conexionado de altavoz de su automóvil.

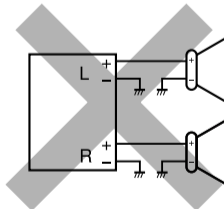

**PRECAUTIONS sur l'alimentation et la connexion des enceintes:**

- NE CONNECTEZ PAS les fils d'enceintes du cordon d'alimentation à la batterie; sinon, l'appareil serait sérieusement endommagé.
- AVANT de connecter les fils d'enceintes du cordon d'alimentation aux enceintes, vérifiez le câblage des enceintes de votre voiture.

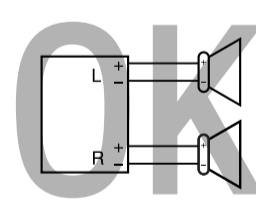

**TROUBLESHOOTING**

- The fuse blows.
  - \* Are the red and black leads connected correctly?
- Power cannot be turned on.
  - \* Is the yellow lead connected?
- No sound from the speakers.
  - \* Is the speaker output lead short-circuited?
- Sound is distorted.
  - \* Is the speaker output lead grounded?
  - \* Are the "-" terminals of L and R speakers grounded in common?
- Noise interfere with sounds.
  - \* Is the rear ground terminal connected to the car's chassis using shorter and thicker cords?
- Receiver becomes hot.
  - \* Is the speaker output lead grounded?
  - \* Are the "-" terminals of L and R speakers grounded in common?
- This receiver does not work at all.
  - \* Have you reset your receiver?

**LOCALIZACION DE AVERIAS**

- El fusible se quema.
  - \* ¿Están los conductores rojo y negro correctamente conectados?
- No es posible conectar la alimentación.
  - \* ¿Está el cable amarillo conectado?
- No sale sonido de los altavoces.
  - \* ¿Está el cable de salida del altavoz cortocircuitado?
- El sonido presenta distorsión.
  - \* ¿Está el cable de salida del altavoz conectado a masa?
  - \* ¿Están los terminales "-" de los altavoces L y R conectados a una masa común?
- Perturbación de ruido.
  - \* ¿El terminal de tierra trasero está conectado al chasis del automóvil utilizando los cordones más corto y más grueso?
- La unidad se calienta.
  - \* ¿Está el cable de salida del altavoz conectado a masa?
  - \* ¿Están los terminales "-" de los altavoces L y R conectados a una masa común?
- Este receptor no funciona en absoluto.
  - \* ¿Reinicializó el receptor?

**EN CAS DE DIFFICULTES**

- Le fusible saute.
  - \* Les fils rouge et noir sont-ils raccordés correctement?
- L'appareil ne peut pas être mise sous tension.
  - \* Le fil jaune est-elle raccordée?
- Pas de son des enceintes.
  - \* Le fil de sortie d'enceinte est-il court-circuité?
- Le son est déformé.
  - \* Le fil de sortie d'enceinte est-il à la masse?
  - \* Les bornes "-" des enceintes gauche et droit sont-elles mises ensemble à la masse?
- Interférence avec les sons.
  - \* La prise arrière de mise à la terre est-elle connectée au châssis de la voiture avec un cordon court et épais?
- L'appareil devient chaud.
  - \* Le fil de sortie d'enceinte est-il à la masse?
  - \* Les bornes "-" des enceintes gauche et droit sont-elles mises ensemble à la masse?
- Cet appareil ne fonctionne pas du tout.
  - \* Avez-vous réinitialisé votre appareil?



**A Typical Connections / Conexiones típicas / Raccordements typiques**

**Before connecting:** Check the wiring in the vehicle carefully. Incorrect connection may cause serious damage to this receiver.

The leads of the power cord and those of the connector from the car body may be different in color.

- 1 Connect the colored leads of the power cord in the order specified in the illustration below.
- 2 Connect the antenna cord.
- 3 Finally connect the wiring harness to the receiver.

**Antes de la conexión:** Verifique atentamente el conexionado del vehículo. Una conexión incorrecta podría producir daños graves en la unidad.

Los cordones del cable de alimentación y los del conector procedentes de la carrocería del automóvil podrían ser de diferentes en color.

- 1 Conecte los conductores de color del cable de alimentación en el orden especificado en la ilustración de abajo.
- 2 Conecte el cable de antena.
- 3 Por último, conecte el cable de alimentación a la unidad.

**Avant de commencer la connexion:** Vérifiez attentivement le câblage du véhicule. Une connexion incorrecte peut endommager sérieusement l'appareil.

Le fil du cordon d'alimentation et ceux des connecteurs du châssis de la voiture peuvent être différents en couleur.

- 1 Connectez les fils colorés du cordon d'alimentation dans l'ordre spécifié sur l'illustration ci-dessous.
- 2 Connectez le cordon d'antenne.
- 3 Finalement, connectez le faisceau de fils à l'appareil.

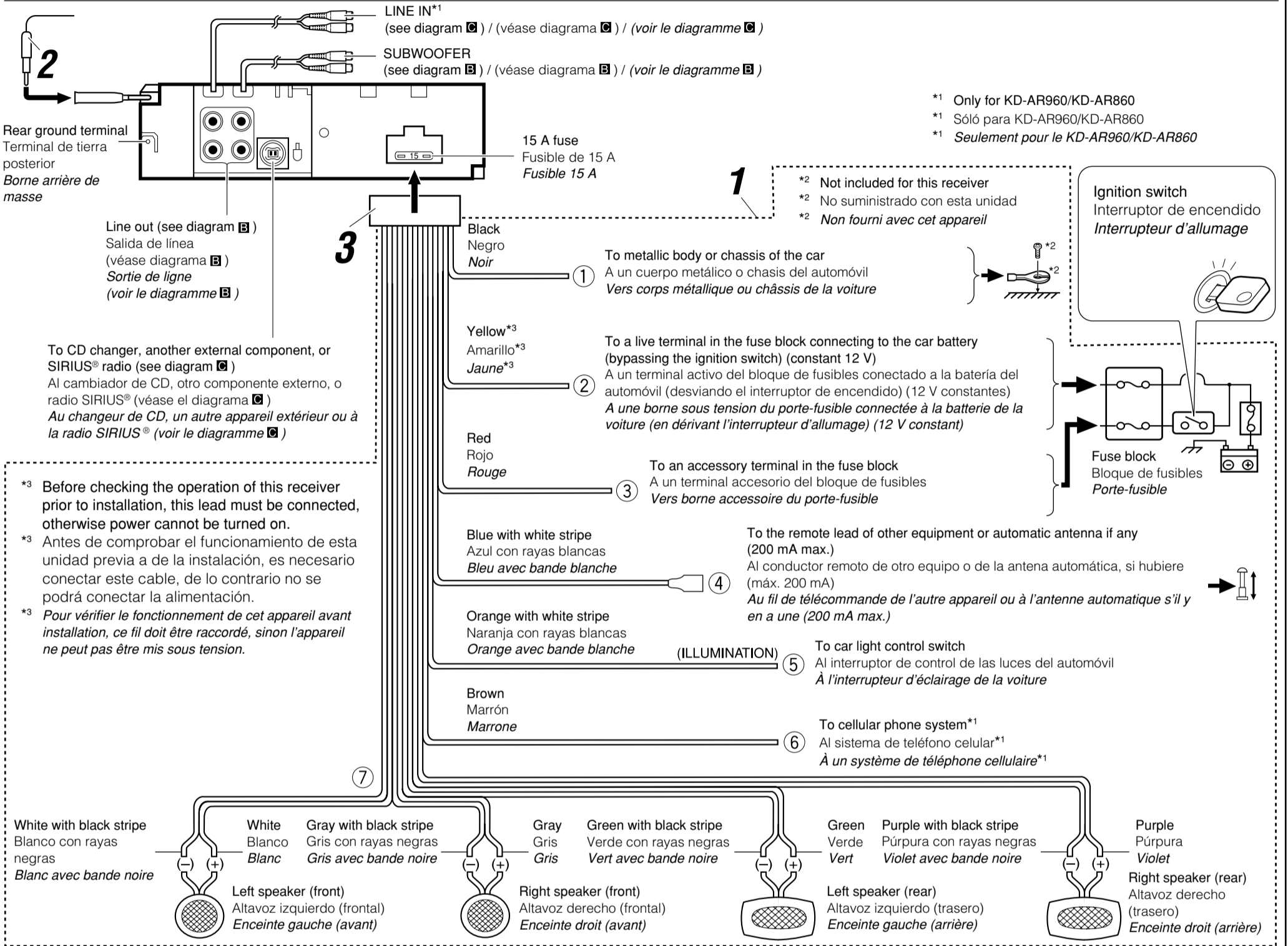

**C Connecting other external components / Conexión de otros componentes externos / Connexion d'un autre appareil extérieur**

**JVC CD changer and DLP (Down Link Processor) / Cambiador de CD de JVC y DLP ("Down Link Processor") JVC / Changeur de CD JVC et Processeur DLP (Processeur de signaux satellite-terre) JVC**

- Set "Ext Input" to "Changer" (For KD-AR960/KD-LH910: see page 32; For KD-AR860/KD-LH810: see page 31 of the INSTRUCTIONS.) / Ajuste "Ext Input" a "Changer" (Para KD-AR960/KD-LH910: consulte la página 32; para KD-AR860/KD-LH810: consulte la página 31 del MANUAL DE INSTRUCCIONES.) / Réglez "Ext Input" sur "Changer" (pour le KD-AR960/KD-LH910: référez-vous à la page 32; pour le KD-AR860/KD-LH810: référez-vous à la page 31 du MANUEL D'INSTRUCTIONS.)

- You can connect both components in series as illustrated below.
- Podrá conectar ambos componentes en serie, tal como se observa en la ilustración de abajo.
- Vous pouvez connecter les deux appareils en série comme montré sur l'illustration ci-dessous.

\*6 Signal cord supplied for your JVC CD changer or DLP  
\*6 Cable de señal suministrado con su cambiador de CD o DLP JVC  
\*6 Cordon de signal fourni avec votre changeur de CD ou processeur DLP JVC

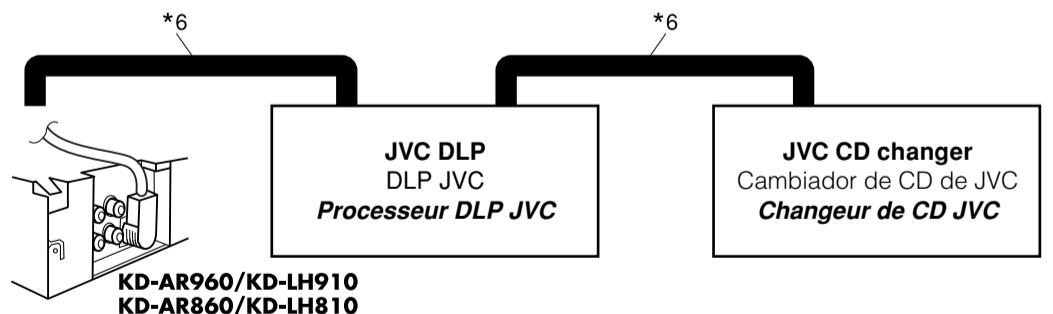

**CAUTION / PRECAUCION / PRECAUTION:**

- Before connecting the CD changer and/or JVC DLP, make sure that the receiver is turned off.
- Antes de conectar el cambiador de CD y/o DLP JVC, asegúrese de que el receptor esté apagado.
- Avant de connecter votre changeur de CD et/ou votre processeur DLP JVC, assurez-vous que l'autoradio est hors tension.

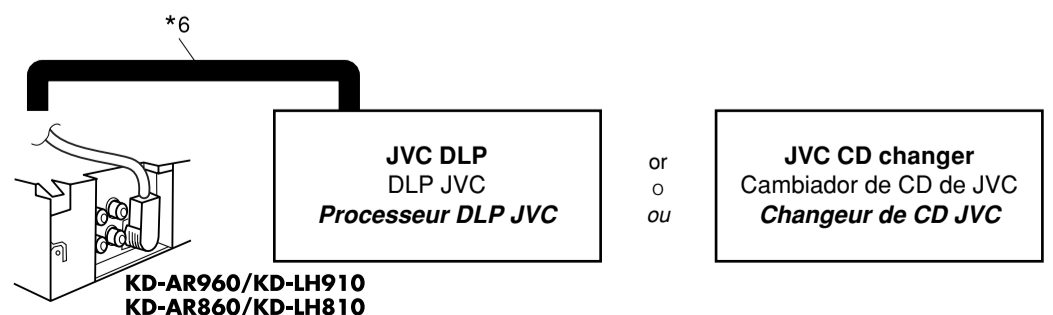

## B Connecting the external amplifiers / Conexión de los amplificadores externos / Connexion d'amplificateurs extérieurs

You can connect amplifiers to upgrade your car stereo system.

- Connect the remote lead (blue with white stripe) to the remote lead of the other equipment so that it can be controlled through this receiver.
- **For amplifier only:**  
**Disconnect the speakers from this receiver, connect them to the amplifier. Leave the speaker leads of this receiver unused.**
  - Only for KD-AR960/KD-AR860: You can switch off the built-in amplifier and send the audio signals only to the external amplifier(s) to get clear sounds and to prevent internal heat built-up inside the receiver. For KD-AR960: see page 33; For KD-AR860: see page 31 of the INSTRUCTIONS (separate volume).
  - The line output level of this receiver is kept high to maintain the hi-fi sounds reproduced from this receiver. When connecting an external amplifier to this receiver, turn down the gain control on the external amplifier to obtain the best performance from this receiver.

Usted podrá conectar amplificadores para mejorar el sistema estéreo de su automóvil.

- Conecte el conductor remoto (azul con rayas blancas) al conductor remoto del otro equipo para poderlo controlar a través de esta unidad.
- **Sólo para el amplificador:**  
**Desconecte los altavoces de esta unidad y conéctelos al amplificador. Los cables de los altavoces de esta unidad quedan sin usar.**
  - Sólo para KD-AR960/KD-AR860: Podrá desconectar el amplificador incorporado y enviar las señales de audio solamente al(los) amplificador(es) externo(s) para obtener sonidos nítidos y evitar que se caliente el interior de la unidad. Para KD-AR960: véase la página 33; Para KD-AR860: véase la página 31 del MANUAL DE INSTRUCCIONES (volumen separado).
  - El nivel de salida de línea de esta unidad permanece alto para que corresponda con los sonidos de alta fidelidad reproducidos por esta unidad. Cuando conecte un amplificador externo a esta unidad, disminuya el control de ganancia del amplificador externo para obtener un óptimo rendimiento de esta unidad.

Vous pouvez connecter des amplificateurs pour améliorer votre système autoradio.

- Connectez le fil de commande à distance (bleu avec bande blanche) au fil de commande à distance de l'autre appareil de façon qu'il puisse être commandé via cet appareil.
- **Pour l'amplificateur seulement:**  
**Déconnectez les enceintes de cet appareil et connectez-les à l'amplificateur. Laissez les fils d'enceintes de cet appareil inutilisés.**
  - Uniquement pour le KD-AR960/KD-AR860: Vous pouvez mettre hors service l'amplificateur intégré et envoyer les signaux audio uniquement sur un ou plusieurs amplificateurs extérieurs afin d'obtenir un son clair et d'éviter tout échauffement interne de l'autoradio. Pour le KD-AR960: référez-vous à la page 33; Pour le KD-AR860: référez-vous à la page 31 du MANUEL D'INSTRUCTIONS (volume séparé).
  - Le niveau de sortie de ligne de cet appareil est maintenu à un niveau élevé pour maintenir une qualité Hi-Fi pour les sons reproduits par cet appareil. Lors de la connexion d'un amplificateur extérieur à cet appareil, diminuez le réglage du gain sur l'amplificateur extérieur pour obtenir les meilleures performances de cet appareil.

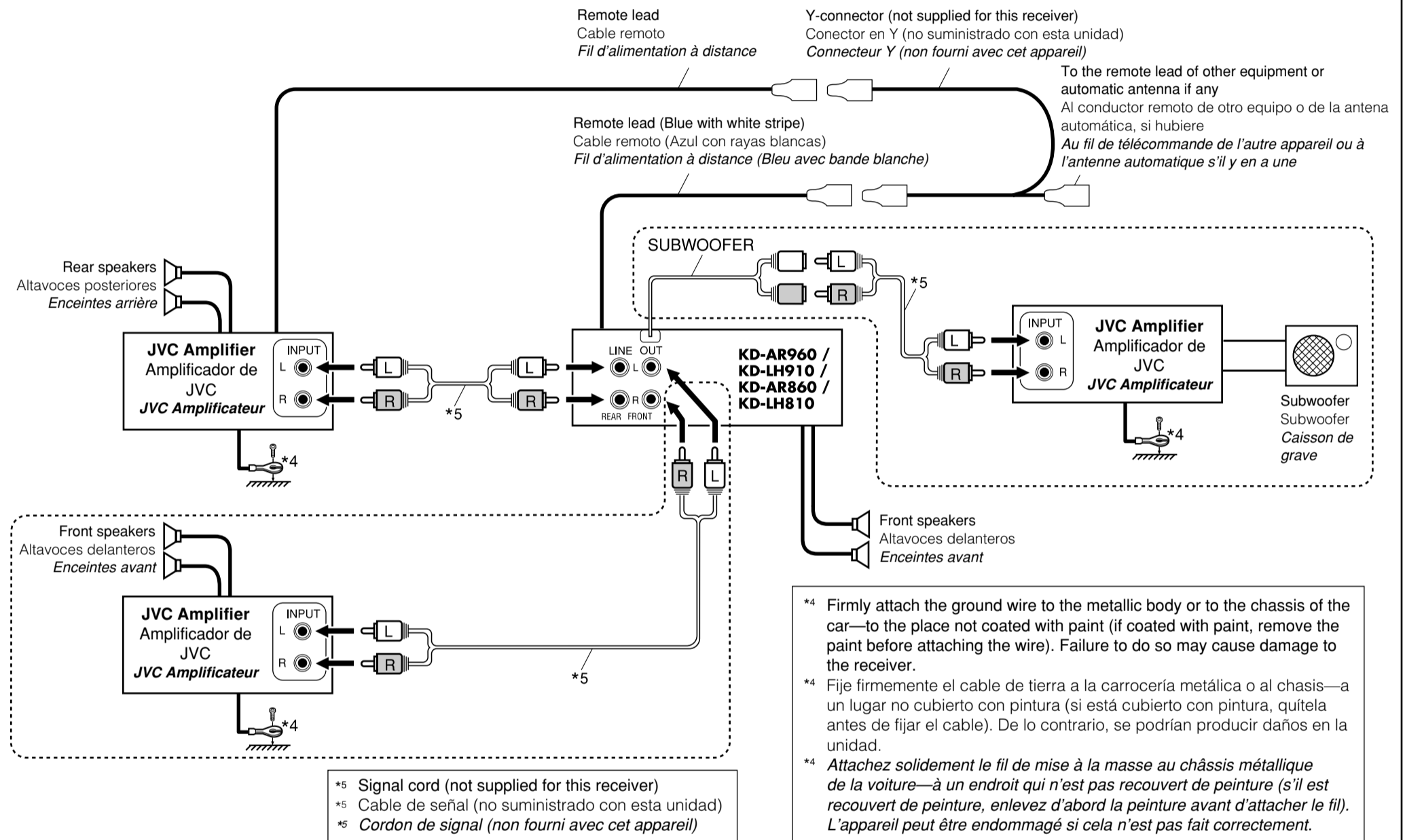

## JVC PnP (Plug and Play) / PnP ("Plug and Play") JVC / PnP ("Plug and Play") JVC

- Set "Ext Input" to "Ext In" (For KD-AR960/KD-LH910: see page 32; For KD-AR860/KD-LH810: see page 31 of the INSTRUCTIONS.) / Ajuste "Ext Input" a "Ext In" (Para KD-AR960/KD-LH910: consulte la página 32; para KD-AR860/KD-LH810: consulte la página 31 del MANUAL DE INSTRUCCIONES.) / Réglez "Ext Input" sur "Ext In" (pour le KD-AR960/KD-LH910: référez-vous à la page 32; pour le KD-AR860/KD-LH810: référez-vous à la page 31 du MANUEL D'INSTRUCTIONS.)

You can also connect JVC PnP through this receiver using JVC SIRIUS radio adapter, KS-U100K (not supplied).

- Turning on/off the receiver can also turn on/off the JVC PnP.
- También podrá conectar la PnP JVC a través de este receptor utilizando el adaptador para radio SIRIUS JVC, KS-U100K (no suministrado).
- Al encender/apagar el receptor también se enciende/apaga la PnP JVC.
- Vous pouvez aussi connecter le PnP JVC à cet autoradio en utilisant l'adaptateur de radio SIRIUS JVC KS-U100K (non fourni).
- Mettre sous/hors tension l'autoradio peut aussi mettre sous/hors tension le PnP JVC.

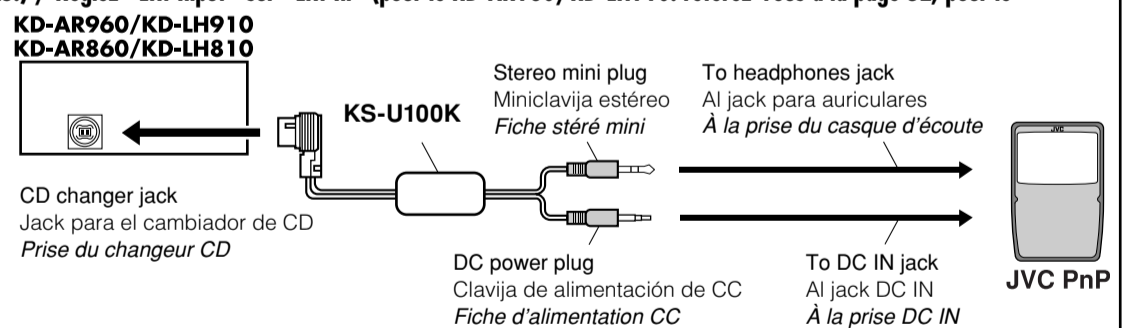

## External Component / Componente exterior / Appareil extérieur

- Set "Ext Input" to "Ext In" (For KD-AR960/KD-LH910: see page 32; For KD-AR860/KD-LH810: see page 31 of the INSTRUCTIONS.) / Ajuste "Ext Input" a "Ext In" (Para KD-AR960/KD-LH910: consulte la página 32; para KD-AR860/KD-LH810: consulte la página 31 del MANUAL DE INSTRUCCIONES.) / Réglez "Ext Input" sur "Ext In" (pour le KD-AR960/KD-LH910: référez-vous à la page 32; pour le KD-AR860/KD-LH810: référez-vous à la page 31 du MANUEL D'INSTRUCTIONS.)

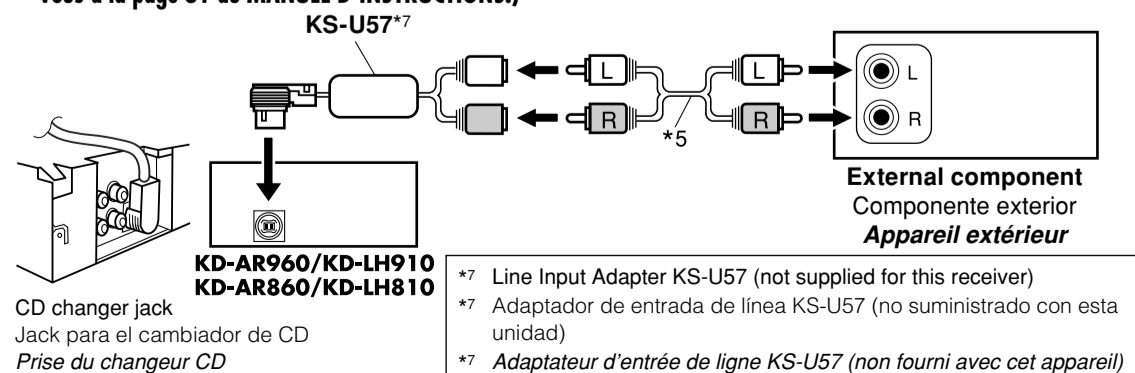

Only for KD-AR960/KD-AR860  
Sólo para KD-AR960/KD-AR860  
Seulement pour le KD-AR960/KD-AR860

