

User Manual

Revision 2.004
English

CAN / Optic Fiber – Repeater – Extender bus line (With filter data configurable)

(Order Code: HD67221F, HD67221FS)

For Website information:

www.adfweb.com?Product=HD67221F

For Price information:

www.adfweb.com?Price=HD67221F

Benefits and Main Features:

- ✦ Low Cost
- ✦ Naturally Resistant to Surges, Spikes and Electrical Noise
- ✦ Multi-mode optical fiber up to 2000 meters
- ✦ MAX baud rate 1Mbps
- ✦ Extension of number of CAN nodes
- ✦ Different baud rate setting
- ✦ CAN protocol independent



User Manual



HD67221F



HD67221FS

For others Repeaters see also the following link:

Optic Fibres Repeaters

- www.adfweb.com?Product=HD67117F (For CANopen)
- www.adfweb.com?Product=HD67117FSX (For CANopen)
- www.adfweb.com?Product=HD67180F (For DeviceNET)
- www.adfweb.com?Product=HD67180FSX (For DeviceNET)
- www.adfweb.com?Product=HD67181F (For CAN 2.0A and CAN 2.0B)
- www.adfweb.com?Product=HD67181FSX (For CAN 2.0A and CAN 2.0B)
- www.adfweb.com?Product=HD67182F (For J1939)
- www.adfweb.com?Product=HD67182FSX (For J1939)
- www.adfweb.com?Product=HD67221FS (Copper Bridge)

CANbus Repeaters

- www.adfweb.com?Product=HD67117 (For CANopen)
- www.adfweb.com?Product=HD67180 (For DeviceNET)
- www.adfweb.com?Product=HD67181 (For CAN 2.0A and CAN 2.0B)
- www.adfweb.com?Product=HD67181 (For J1939)
- www.adfweb.com?Product=HD67221 (Filtrate CAN to CAN)

Do you have an your customer protocol? Then go to:

www.adfweb.com?Product=HD67003

Do you need to choose a device? do you want help?

www.adfweb.com?Cmd=helpme

INDEX:

	Page
INDEX	2
UPDATED DOCUMENTATION	2
REVISION LIST	2
WARNING	2
TRADEMARKS	2
SECURITY ALERT	3
EXAMPLE OF CONNECTION	4
CONNECTION SCHEME	5
CHARACTERISTICS	6
CONFIGURATION	6
POWER SUPPLY	7
FUNCTION MODES	8
LEDS	9
RS232	10
OPTICAL FIBER	10
CAN	11
USE OF COMPOSITOR SW67221FS	13
NEW PROJECT / OPEN PROJECT	13
SET COMMUNICATION	14
SET COBID ACCESS	15
UPDATE DEVICE	16
"F"SERIES	17
"FS"SERIES	18
MECHANICAL DIMENSIONS	19
ORDERING INFORMATIONS	20
ACCESSORIES	20
DISCLAIMER	21
OTHER REGULATIONS AND STANDARDS	21
WARRANTIES AND TECHNICAL SUPPORT	22
RETURN POLICY	22
PRODUCTS AND RELATED DOCUMENTS	22

UPDATED DOCUMENTATION:

you need to check that the following document is:

- Updated
- Related to the product you own

To obtain the most recently updated document, note the "document code" that appears at the top right-hand corner of each page of this document.

With this "Document Code" go to web page www.adfweb.com/download/ and search for the corresponding code on the page. Click on the proper "Document Code" and download the updates.

REVISION LIST:

Revision	Date	Author	Chapter	Description
2.001	28/07/2009	MI	All	Revision
2.002	28/05/2010	FTI	All	Revision
2.003	12/02/2013	Nt	All	Added new chapters
2.004	26/05/2015	FI	All	Revision

WARNING:

ADFweb.com reserves the right to change information in this manual about our product without warning. ADFweb.com is not responsible for any error this manual may contain.

TRADEMARKS:

All trademarks mentioned in this document belong to their respective owners.

SECURITY ALERT:**GENERAL INFORMATION**

To ensure safe operation, the device must be operated according to the instructions in the manual. When using the device, legal and safety regulation are required for each individual application. The same applies also when using accessories.

INTENDED USE

Machines and systems must be designed so the faulty conditions do not lead to a dangerous situation for the operator (i.e. independent limit switches, mechanical interlocks, etc.).

QUALIFIED PERSONNEL

The device can be used only by qualified personnel, strictly in accordance with the specifications.

Qualified personnel are persons who are familiar with the installation, assembly, commissioning and operation of this equipment and who have appropriate qualifications for their job.

RESIDUAL RISKS

The device is state-of-the-art and is safe. The instruments can represent a potential hazard if they are inappropriately installed and operated by untrained personnel. These instructions refer to residual risks with the following symbol:



This symbol indicates that non-observance of the safety instructions is a danger for people that could lead to serious injury or death and / or the possibility of damage.

CE CONFORMITY

The declaration is made by our company. You can send an email to support@adfweb.com or give us a call if you need it.

EXAMPLE OF CONNECTION:

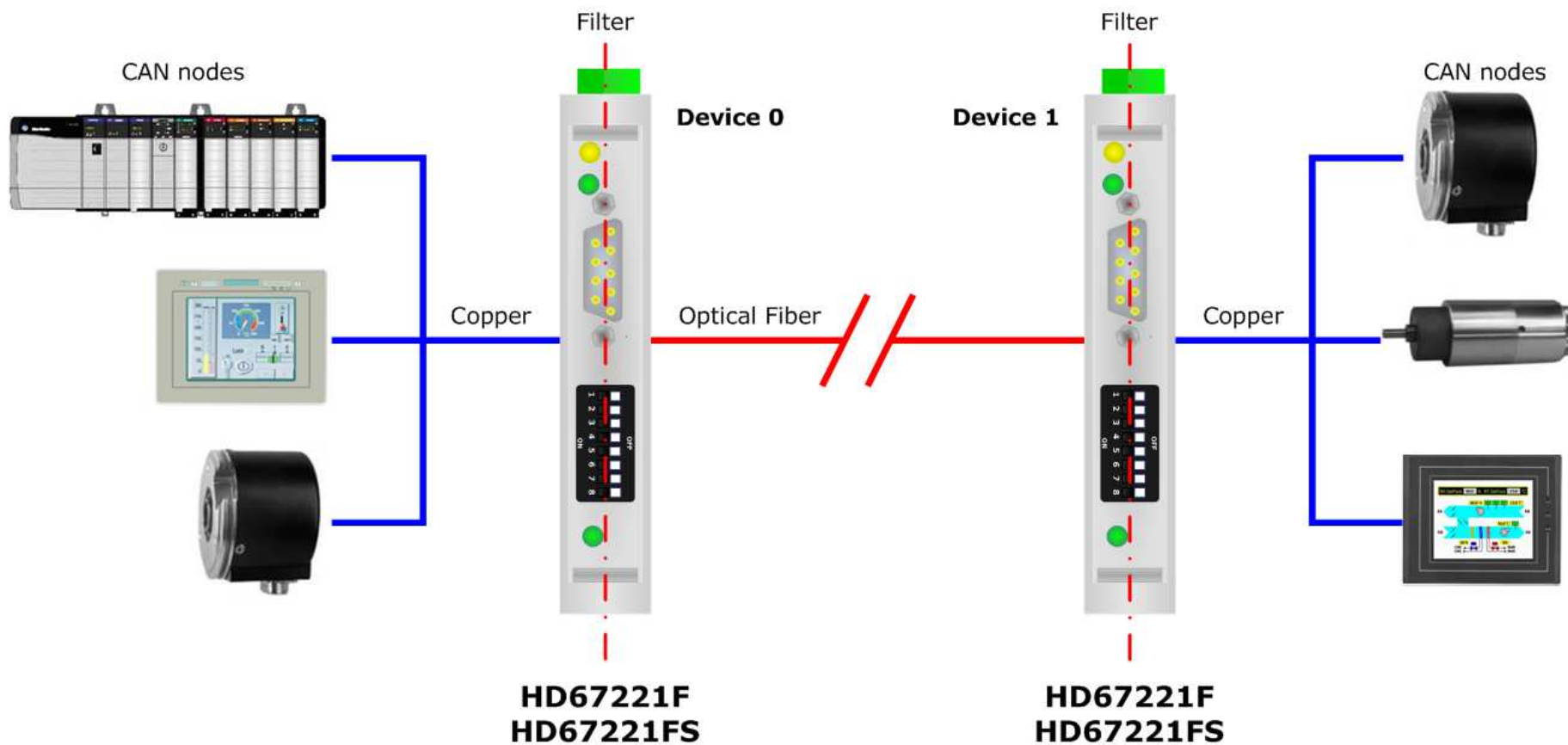

CONNECTION SCHEME:

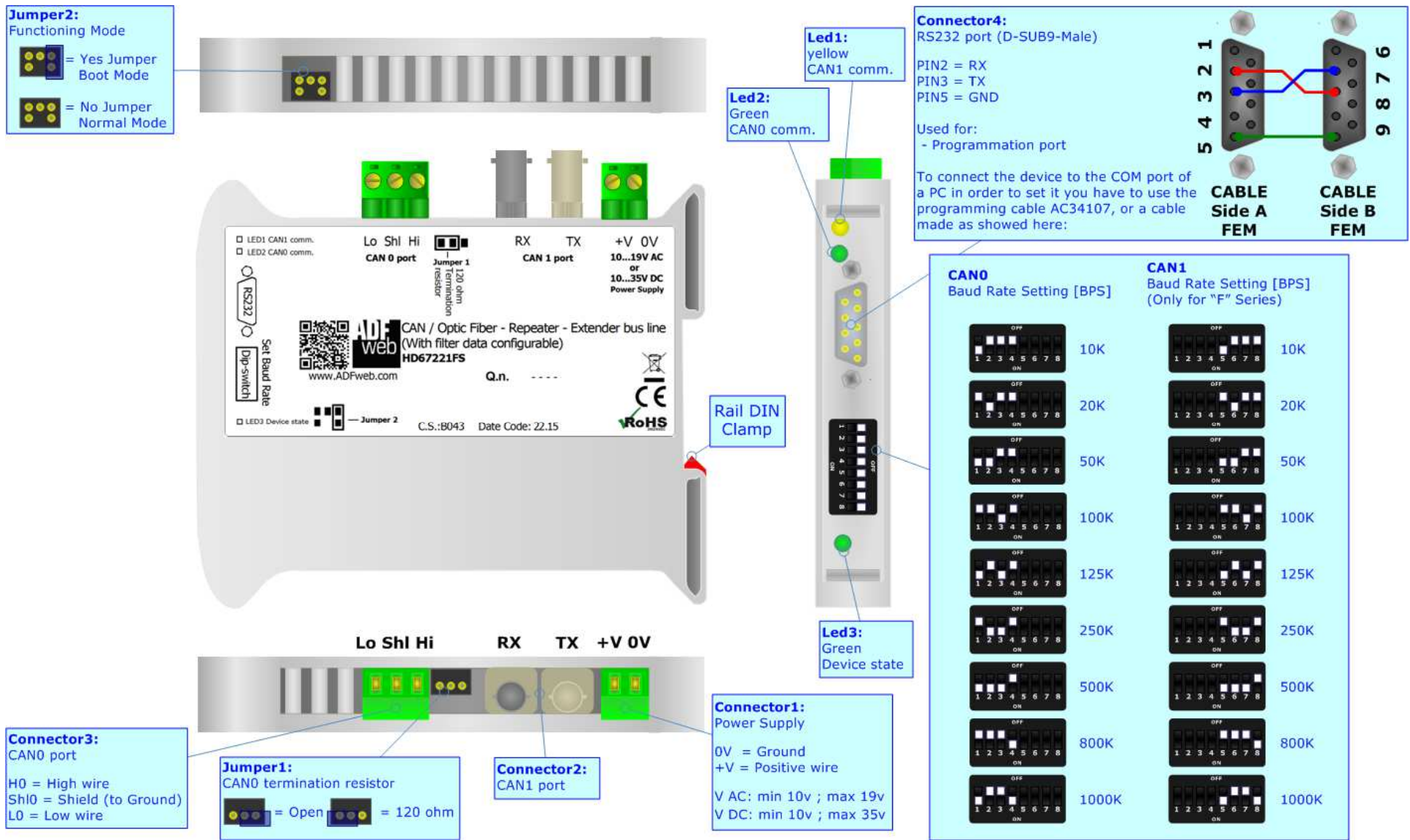

Figure 1: Connection scheme for HD67221F and HD67221FS

CHARACTERISTICS:

The HD67221F and HD67221FS are configurable CAN COB-ID filter repeaters.

They have the following characteristics:

- ➔ Electrical isolation between two buses;
- ➔ Two-directional information between two distinct CAN buses;
- ➔ Mountable on 35mm Rail DIN;
- ➔ Filter of CAN frames;
- ➔ Wide power supply input range: 10...19V AC or 10...35V DC;
- ➔ Wide temperature range: -40°C / 85°C [-40°F / +185°F].

CONFIGURATION:

You need Compositor SW67221 software on your PC in order to perform the following:

- ➔ Define the parameters of CAN line;
- ➔ Define the filter map of COB-ID that can pass through the Repeater (up to 2048 COB-ID for CAN2.0A and up to 2000 COB-ID for CAN2.0B);
- ➔ Update the device.

POWER SUPPLY:

The devices can be powered at 10...19V AC and 10...35V DC. For more details see the two tables below.

VAC		VDC	
Vmin	Vmax	Vmin	Vmax
10V	19V	10V	35V

Consumption at 24V DC:

Device	Consumption [W/VA]
HD67221F	3.5
HD67221FS	3.5

Connector1:
Power Supply
0V = Ground
+V = Positive wire
V AC: min 10v ; max 19v
V DC: min 10v ; max 35v



Caution: Do not reverse the polarity power

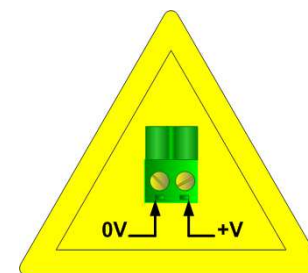

HD67221F
HD67221FS

FUNCTION MODES:

The device has got two function modes depending on the position of the 'Jumper2':

- The first, with 'Jumper2' not inserted, is used for the normal working of the device.
- The second, with 'Jumper2' inserted, is used for uploading the Project and/or Firmware.

For the operations to follow for the updating, see 'UPDATE DEVICE' section.

According to the functioning mode, the LEDs will have specific functions, see 'LEDS' section.

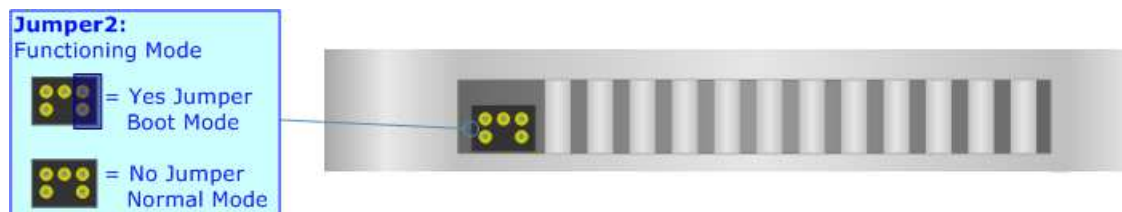

LEDS:

The device has got three LEDs that are used to give information about the functioning status.
The various meanings of the LEDs are described in the table below.

LED	Normal Mode	Boot Mode
1: CAN1 comm. (green)	Change state when receive a CAN frame on CAN1 port	Off
2: CAN0 comm. (green)	Change state when receive a CAN frame on CAN0 port	Blinks quickly
3: Device state (green)	Blinks slowly	Off

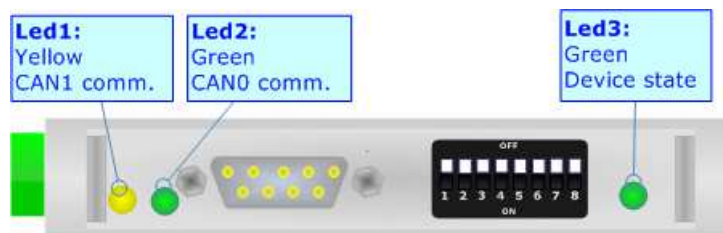

RS232:

The connection from RS232 socket to a serial port (example one from a personal computer) must be made with a NULL MODEM cable (a serial cable where the pins 2 and 3 are crossed).

It is recommended that the RS232 cable not exceed 15 meters.

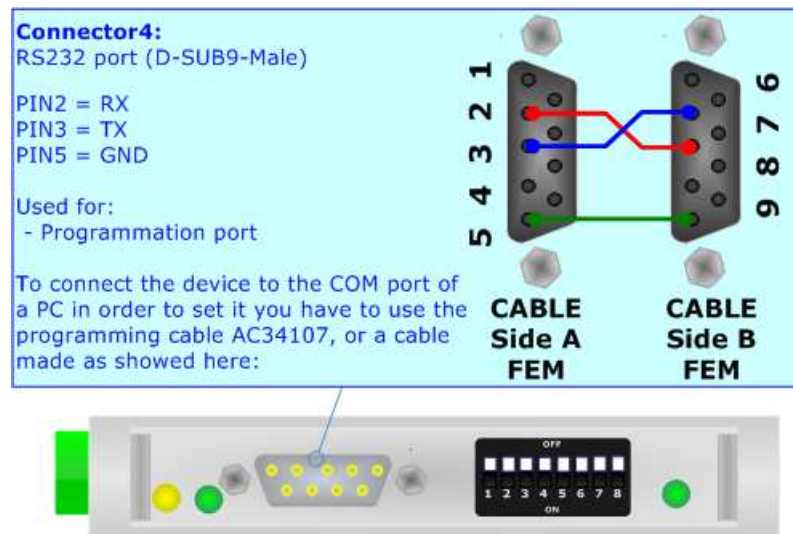

OPTICAL FIBER:

The fiber optic connection must be made with a 62.5/125µm multi-mode fiber equipped with ST connector.

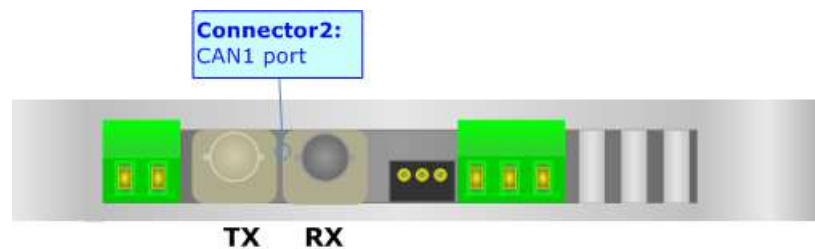

CAN:

To terminate the CAN line with a 120Ω resistor it is necessary to insert the 'Jumper1' like in figure.

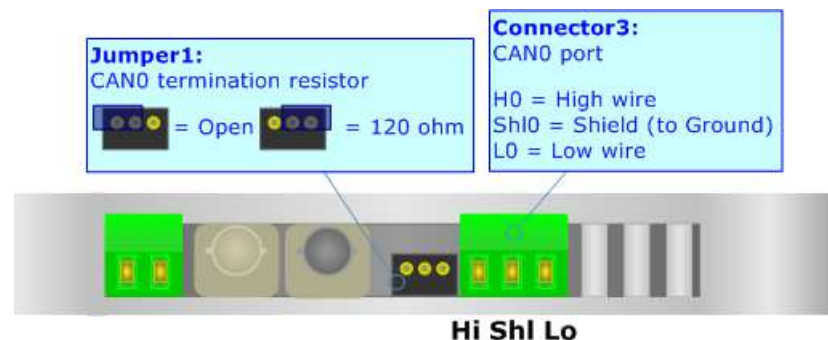

Cable characteristics:

DC parameter:	Impedance	70 Ohm/m
----------------------	-----------	----------

AC parameters:	Impedance	120 Ohm/m
	Delay	5 ns/m

Length	Baud Rate [bps]	Length MAX [m]
	10 K	5000
	20 K	2500
	50 K	1000
	100 K	650
	125 K	500
	250 K	250
	500 K	100
	800 K	50
	1000 K	25

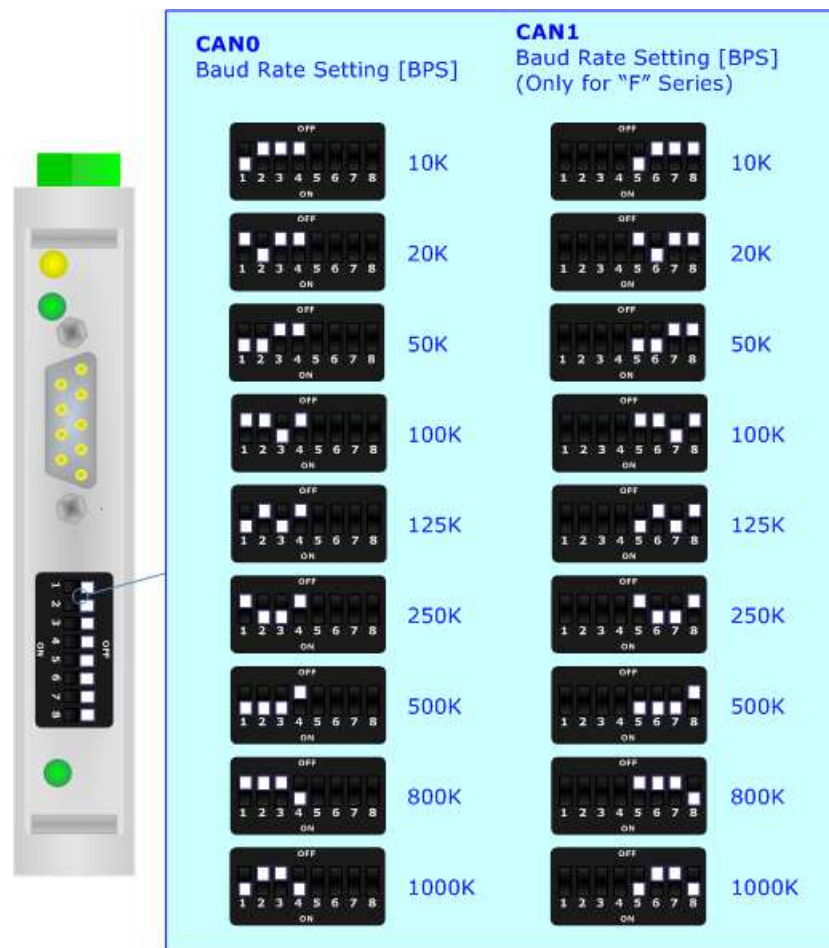

Baud rate selected by Dip-Switch

The baud rate of "CAN 0" and "CAN 1" could be defined through the dip-switch present in device. These are the possible combinations:

Dip n° 1, 2, 3, 4 "CAN 0" setting;
Dip n° 5, 6, 7, 8 "CAN 1" setting.

Speed "CAN 1" BPS (Only for "F" Series)	Dip 5	Dip 6	Dip 7	Dip 8
Speed "CAN 0" BPS	Dip 1	Dip 2	Dip 3	Dip 4
10K	ON	OFF	OFF	OFF
20K	OFF	ON	OFF	OFF
50K	ON	ON	OFF	OFF
100K	OFF	OFF	ON	OFF
125K	ON	OFF	ON	OFF
250K	OFF	ON	ON	OFF
500K	ON	ON	ON	OFF
800K	OFF	OFF	OFF	ON
1000K	ON	OFF	OFF	ON

USE OF COMPOSITOR SW67221FS:

To configure the Converter, use the available software that runs with Windows, called SW67221. It is downloadable on the site www.adfweb.com and its operation is described in this document. *(This manual is referenced to the last version of the software present on our web site).* The software works with MSWindows (XP, Vista, Seven, 8; 32/64bit).

When launching the SW67221FS the right window appears (Fig. 2).

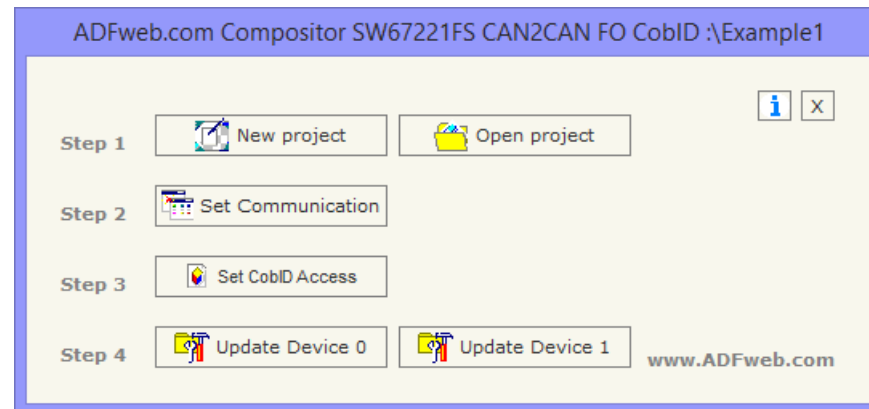
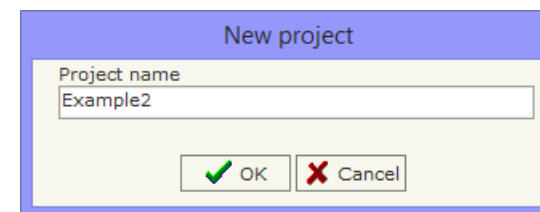
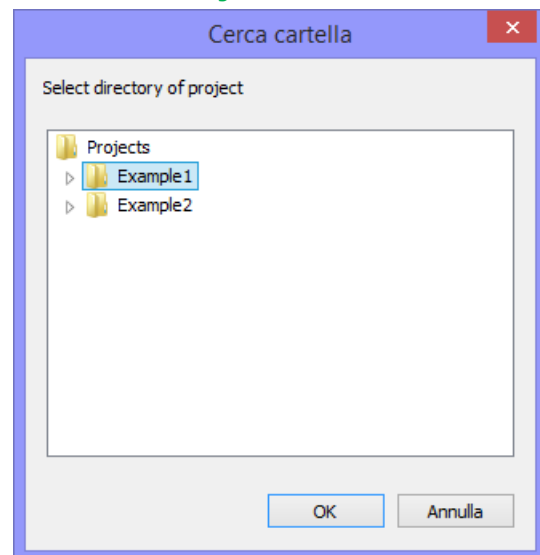

Figure 2: Main window for SW67221FS

NEW PROJECT / OPEN PROJECT:

The **New Project** button creates the folder which contains the entire device configuration.



A device configuration can also be imported or exported:

- To clone the configurations of a Programmable "CAN / Optic Fiber – Repeater – Extender bus line" in order to configure another device in the same manner, it is necessary to maintain the folder and all its contents;
- To clone a project in order to obtain a different version of the project, it is sufficient to duplicate the project folder with another name and open the new folder with the button **Open Project**.

SET COMMUNICATION:

This section define the fundamental communication parameters of converter.

By Pressing the “**Set Communication**” button from the main window for SW67221FS (Fig. 2) the window “Set Communication” appears (Fig. 3).

The window is divided in three sections, the first is used for setting the parameters of Device 0, the second for setting the parameters of Device 1 and the other for selecting the type of CAN network.

The means of the fields for “Device 0” and “Device 1” are:

- If the field “**Baudrate set with Dip Switch**” is checked, the baudrate is taken from the position of Dip-Switch in the front of the converter. Otherwise if isn’t checked, you have to select the baudrate from the list in the field “**Baud rate**”.

The parameter “Type of CAN Network” define if the CAN is “**CAN 2.0A**” (CobID at 11 Bit) or “**CAN 2.0B**” (CobID at 29 Bit).

If the field “**Positive Implementation**” is checked, only the CobIDs that are written in the “Set CobID Access” table passes in the other CAN bus; otherwise if the field isn’t checked, all the CobID written in the table are blocked by the Repeater.

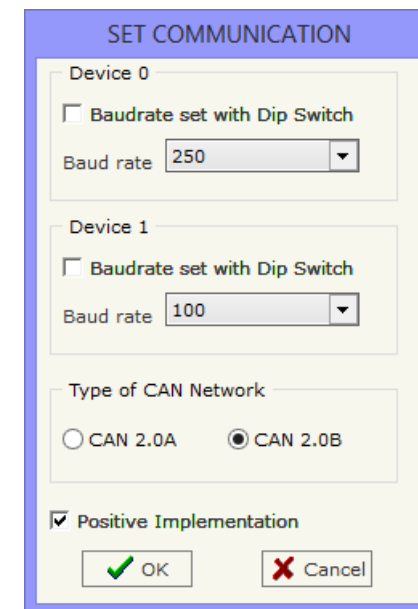

Figure 3: “Set Communication” window

SET COBID ACCESS:

The following objects can be defined:

- Which CAN frames of the "Device 0" pass into "Device 1";
- Which CAN frames of the "Device 1" pass into "Device 0".

If the "Positive Implementation" parameter is set, it is possible to change the CobID of the frame when it passes from one Device to the other. In order to do this it is necessary to insert the new CobID in the "Modify CobID" column.

The dimension of data and its value do not change when it passes into the Repeater.

The data of the columns have the following meaning:

- In the field "**Original CobID**" insert the CobID that can pass in the other CAN network (if Positive Implementation is not checked then the indicated CobID cannot pass to other CAN Network);
- In the field "**Modify CobID**" insert the new CobID of the frame that passes in the other CAN network (only if "Positive Implementation" is checked);
- In the field "**Description**" you can insert the description of the Can Frame.

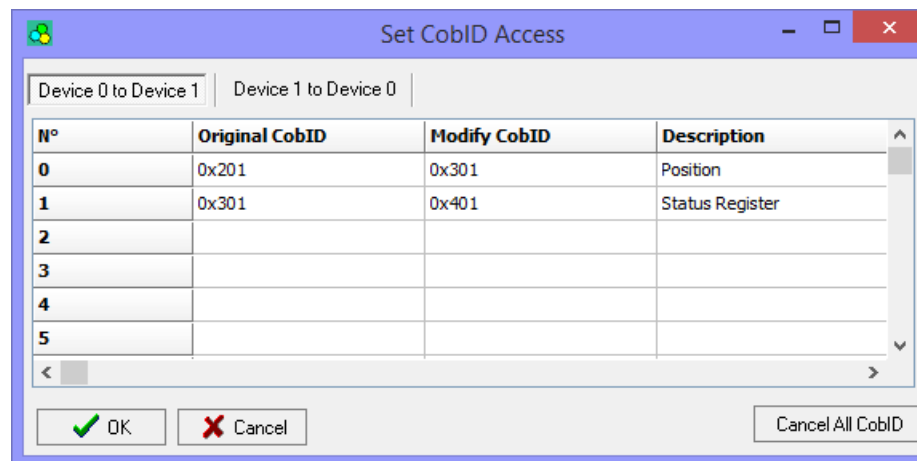

Figure 4: "Set CobID Access" window

Example 1:

If I want to pass the CobID 0x181 from "Device 0" to "Device 1" and set it like 0x189 in "Device 1", I need to set the follow parameter in table "CAN 0 to CAN1":

- Original CobID 0x181;
- Modify CobID 0x189.

In the above example (Fig. 5):

All the Can frames with CobID different from the "Original CobID" column are blocked. The Can frames with CobID equal to the "Original CobID" column are sent to "Device 1" with the new CobID.

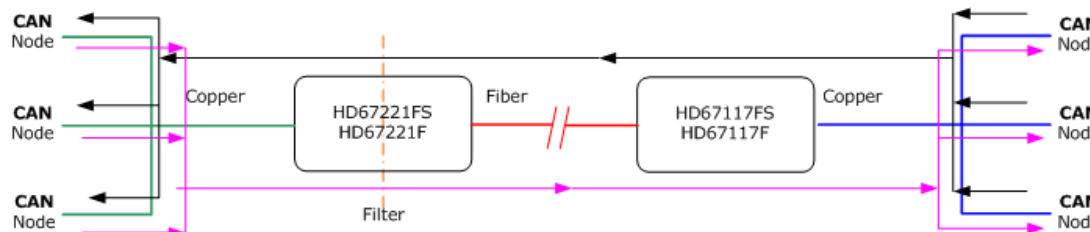

UPDATE DEVICE:

By pressing the **“Update Device 0”** button or **“Update Device 1”** button, it is possible to load the created Configuration into the device; and also the Firmware. There are two buttons; one for every device in the configuration.

In order to load the parameters and update the firmware in the devices, follow these instructions:

- Turn off the Device;
- Connect the RS232 cable form your PC to the Repeater;
- Put Jumper2 in Boot position (see “FUNCTION MODES” section);
- Turn on the device;
- Check the BOOT Led. It must blink quickly (see “LEDS” section);
- Select the **“COM port”** and press the **“Execute update firmware”** button to start the upload;
- When appears “Update Done” turn off the device;
- Disconnect the Boot jumper;
- Disconnect the RS232 Cable;
- Turn on the device.

At this point the configuration/firmware on the device is correctly updated.

 In the case of HD67221F or HD67221FS you have to use the software “SW67221FS”: www.adfweb.com/download/filefold/SW67221FS.zip.

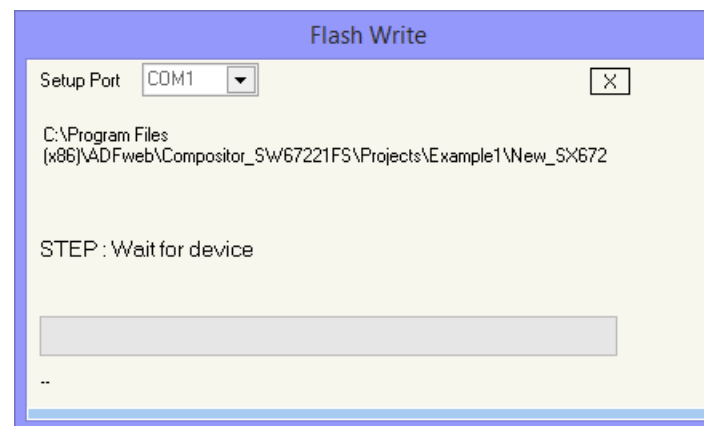
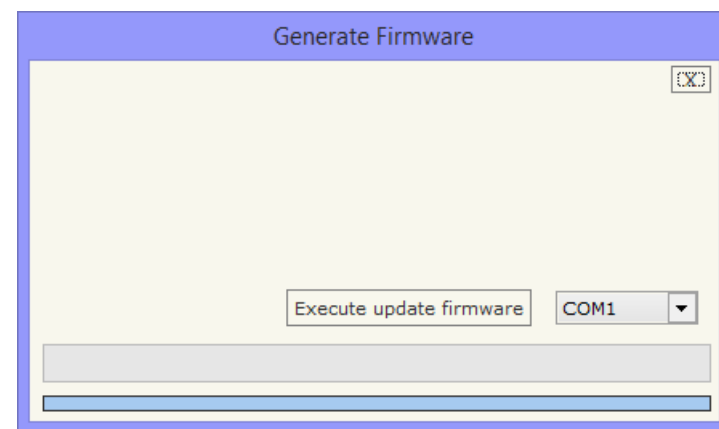

Figure 5: “Update device” window

"F" SERIES:

Bridges and repeaters for CANbus, CANopen, DeviceNET, J1939, CAN2.0A, CAN2.0B:

HD67221F CAN / optic Fiber – Repeater – Extender bus line (with filter data configurable)

Function scheme:

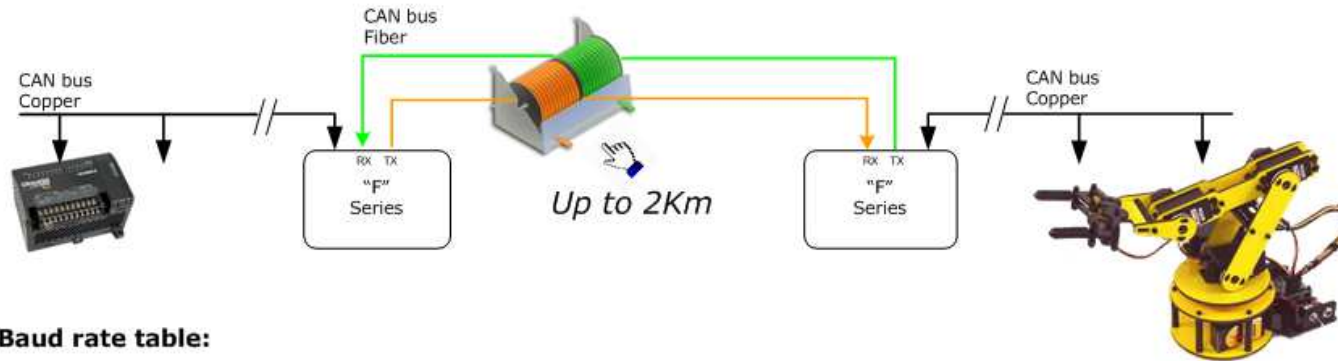

Baud rate table:

Copper Side:

Baud rate [bps]	Lenght max [m]
10 K	5000
20 K	2500
50 K	1000
100 K	650
125 K	500
250 K	250
500 K	100
800 K	50
1000 K	25

Fiber Optic Side:

Baud rate [bps]	Lenght max [m]
10 K	2000
20 K	2000
50 K	1000 (*)
100 K	650 (*)
125 K	500 (*)
250 K	250 (*)
500 K	100 (*)
800 K	50 (*)
1000 K	25 (*)

www.ADFweb.com

(*) Link distance is limited by signaling rate as specified by the CAN bus specification to bus arbitration.

Figure 6: Function scheme and Baud rate table for "F"

“FS” SERIES:

Bridges and repeaters for CANbus, CANopen, DeviceNET, J1939, CAN2.0A, CAN2.0B:

HD67221FS CAN / optic Fiber – Repeater – Extender bus line (with filter data configurable)

These series of device use the large bandwidth of optics fibres for extend the CAN bus link.

Function scheme:

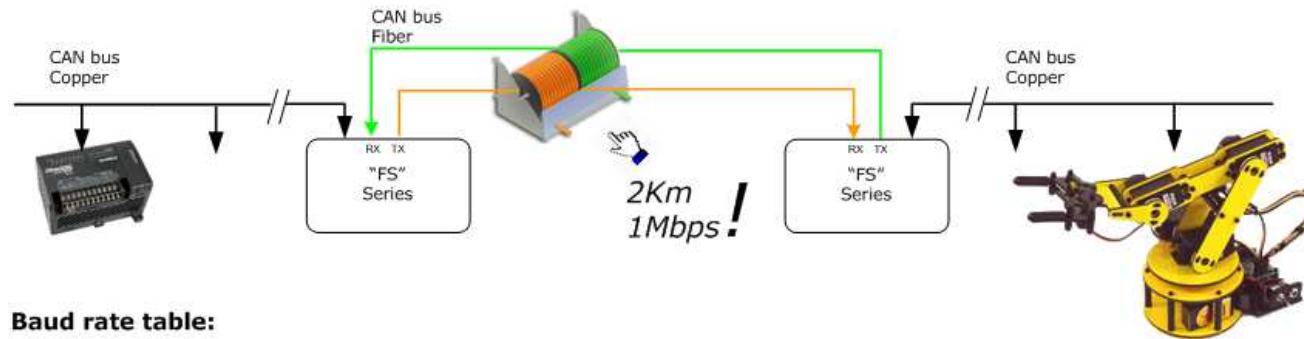

Baud rate table:

Copper Side:

Baud rate [bps]	Lenght max [m]
10 K	5000
20 K	2500
50 K	1000
100 K	650
125 K	500
250 K	250
500 K	100
800 K	50
1000 K	25

Fiber Optic Side: (*)

Baud rate [bps]	Lenght max [m]
10 K	2000
20 K	2000
50 K	2000
100 K	2000
125 K	2000
250 K	2000
500 K	2000
800 K	2000
1000 K	2000

www.ADFweb.com

(*) Fiber optic 62.5/125µm

Figure 7: Function scheme and Baud rate table for “FS”

MECHANICAL DIMENSIONS:

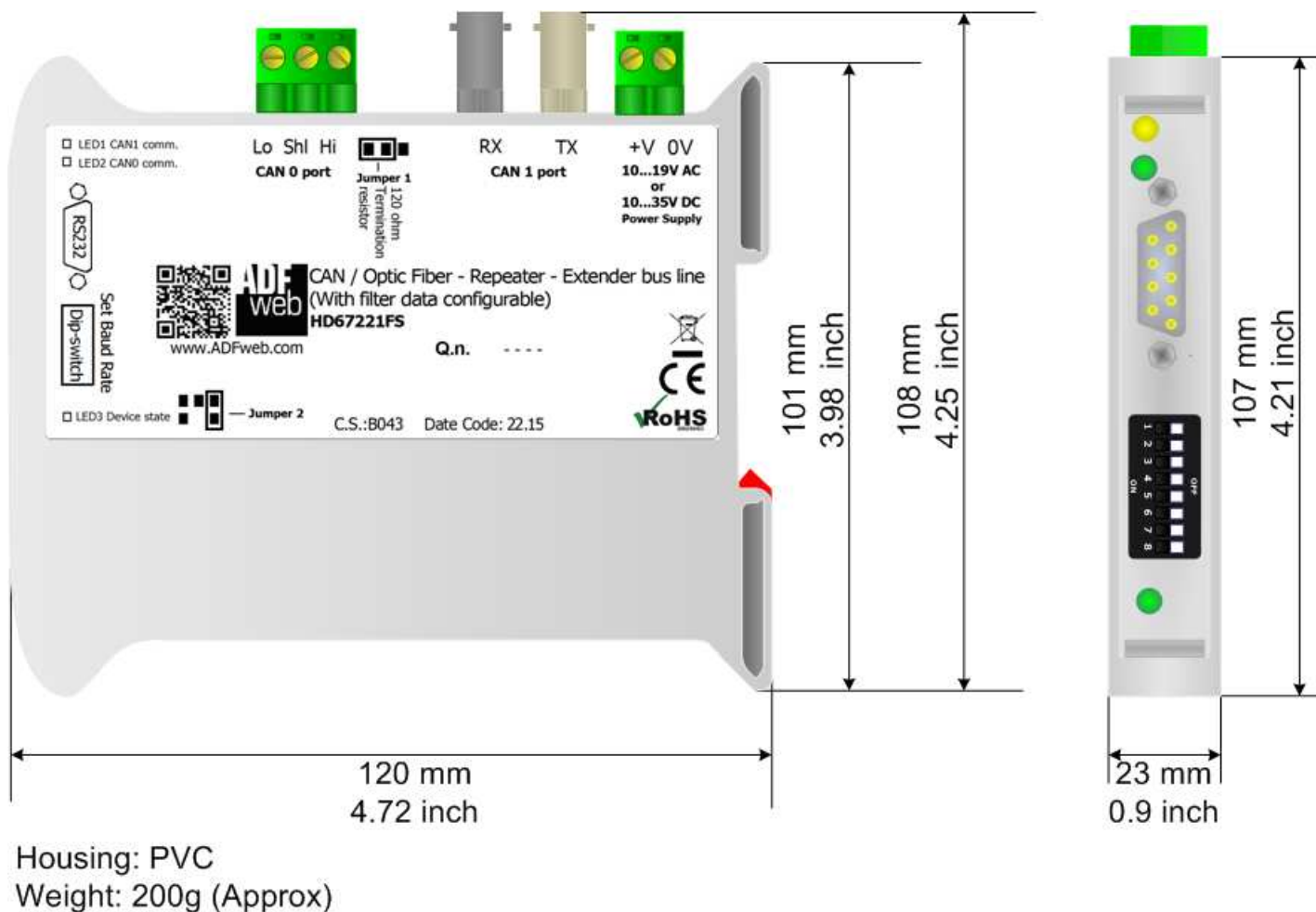

Figure 8: Mechanical dimensions scheme for HD67221F and HD67221FS

ORDERING INFORMATIONS:

HD67221F - CAN / Optic Fiber – Repeater – Extender bus line (With filter data configurable)

HD67221FS - CAN / Optic Fiber – Repeater – Extender bus line (With filter data configurable)

(* Regarding "F" and "FS" series difference, see the above "Baud Rate Table"

ACCESSORIES:

Order Code: **AC34107** - Null Modem Cable Fem/Fem DSub 9 Pin 1,5 m

Order Code: **AC34114** - Null Modem Cable Fem/Fem DSub 9 Pin 5 m

Order Code: **AC34001** - Rail DIN - Power Supply 220/240V AC 50/60Hz – 12 V AC

Order Code: **AC34002** - Rail DIN - Power Supply 110V AC 50/60Hz – 12 V AC

DISCLAIMER:

All technical content within this document can be modified without notice. The content of the document is a under continual renewal. For losses due to fire, earthquake, third party access or other accidents, or intentional or accidental abuse, misuse, or use under abnormal conditions repairs are charged to the user. ADFweb.com S.r.l. will not be liable for accidental loss of use or inability to use this product, such as loss of business income. ADFweb.com S.r.l. shall not be liable for consequences of improper use.

OTHER REGULATIONS AND STANDARDS:**WEEE INFORMATION**

Disposal of old electrical and electronic equipment (as in the European Union and other European countries with separate collection systems).

■ This symbol on the product or on its packaging indicates that this product may not be treated as household rubbish. Instead, it should be taken to an applicable collection point for the recycling of electrical and electronic equipment. If the product is disposed correctly, you will help prevent potential negative environmental factors and impact of human health, which could otherwise be caused by inappropriate disposal. The recycling of materials will help to conserve natural resources. For more information about recycling this product, please contact your local city office, your household waste disposal service or the shop where you purchased the product.

RESTRICTION OF HAZARDOUS SUBSTANCES DIRECTIVE

The device respects the 2002/95/EC Directive on the restriction of the use of certain hazardous substances in electrical and electronic equipment (commonly referred to as Restriction of Hazardous Substances Directive or RoHS).

CE MARKING

The product conforms with the essential requirements of the applicable EC directives.

WARRANTIES AND TECHNICAL SUPPORT:

For fast and easy technical support for your ADFweb.com SRL products, consult our internet support at www.adfweb.com. Otherwise contact us at the address support@adfweb.com

RETURN POLICY:

If while using your product you have any problem and you wish to exchange or repair it, please do the following:

- Obtain a Product Return Number (PRN) from our internet support at www.adfweb.com. Together with the request, you need to provide detailed information about the problem.
- Send the product to the address provided with the PRN, having prepaid the shipping costs (shipment costs billed to us will not be accepted).

If the product is within the warranty of twelve months, it will be repaired or exchanged and returned within three weeks. If the product is no longer under warranty, you will receive a repair estimate.



ADFweb.com S.r.l.
Via Strada Nuova, 17
IT-31010 Mareno di Piave
TREVISO (Italy)
Phone +39.0438.30.91.31
Fax +39.0438.49.20.99
www.adfweb.com

