

AEROTRAK®

HANDHELD AIRBORNE PARTICLE COUNTER MODEL 9306

OPERATION MANUAL



START SEEING THE BENEFITS OF REGISTERING TODAY!

Thank you for your TSI instrument purchase. Occasionally, TSI releases information on software updates, product enhancements and new products. By registering your instrument, TSI will be able to send this important information to you.

<http://register.tsi.com>

As part of the registration process, you will be asked for your comments on TSI products and services. TSI's customer feedback program gives customers like you a way to tell us how we are doing.



UNDERSTANDING, ACCELERATED

TSI Incorporated - Visit our website **www.tsi.com** for more information.

USA	Tel: +1 800 874 2811	India	Tel: +91 80 67877200
UK	Tel: +44 149 4 459200	China	Tel: +86 10 8251 6588
France	Tel: +33 491 11 87 64	Singapore	Tel: +65 6595 6388
Germany	Tel: +49 241 523030		

©2012 TSI Incorporated

Printed in U.S.A.

AEROTRAK®

HANDHELD AIRBORNE PARTICLE COUNTER MODEL 9306

OPERATION MANUAL

P/N 6004215, Revision E
November 2012

SHIP TO/MAIL TO:

TSI Incorporated
500 Cardigan Road
Shoreview, MN 55126-3996
USA

U.S.

Technical Support:

(800) 874-2811/(651) 490-2811

Fax:

(651) 490-3824



E-mail address:

answers@tsi.com

Website:

<http://www.tsi.com>

INTERNATIONAL

Technical Support:

(001 651) 490-2811

Fax:

(001 651) 490-3824



Manual History

The following is a manual history of the AeroTrak[®] Handheld Airborne Particle Counter, Model 9306 Operation Manual (P/N 6004215).

Revision	Date
A	July 2010
B	September 2010
C	February 2011
D	March 2012
E	November 2012

Warranty

Part Number	6004215 / Revision E / November 2012
Copyright	©TSI Incorporated / 2010-2012 / All rights reserved.
Address	TSI Incorporated / 500 Cardigan Road / Shoreview, MN 55126 / USA
E-mail Address	answers@tsi.com
Limitation of Warranty and Liability (effective June 2011)	<p>(For country-specific terms and conditions outside of the USA, please visit www.tsi.com.)</p> <p>Seller warrants the goods sold hereunder, under normal use and service as described in the operator's manual, shall be free from defects in workmanship and material for 24 months, or if less, the length of time specified in the operator's manual, from the date of shipment to the customer. This warranty period is inclusive of any statutory warranty. This limited warranty is subject to the following exclusions and exceptions::</p> <ol style="list-style-type: none">Hot-wire or hot-film sensors used with research anemometers, and certain other components when indicated in specifications, are warranted for 90 days from the date of shipment;Pumps are warranted for hours of operation as set forth in product or operator's manuals;Parts repaired or replaced as a result of repair services are warranted to be free from defects in workmanship and material, under normal use, for 90 days from the date of shipment;Seller does not provide any warranty on finished goods manufactured by others or on any fuses, batteries or other consumable materials. Only the original manufacturer's warranty applies;Unless specifically authorized in a separate writing by Seller, Seller makes no warranty with respect to, and shall have no liability in connection with, goods which are incorporated into other products or equipment, or which are modified by any person other than Seller. <p>The foregoing is IN LIEU OF all other warranties and is subject to the LIMITATIONS stated herein. NO OTHER EXPRESS OR IMPLIED WARRANTY OF FITNESS FOR PARTICULAR PURPOSE OR MERCHANTABILITY IS MADE. WITH RESPECT TO SELLER'S BREACH OF THE IMPLIED WARRANTY AGAINST INFRINGEMENT, SAID WARRANTY IS LIMITED TO CLAIMS OF DIRECT INFRINGEMENT AND EXCLUDES CLAIMS OF CONTRIBUTORY OR INDUCED INFRINGEMENTS. BUYER'S EXCLUSIVE REMEDY SHALL BE THE RETURN OF THE PURCHASE PRICE DISCOUNTED FOR REASONABLE WEAR AND TEAR OR AT SELLER'S OPTION REPLACEMENT OF THE GOODS WITH NON-INFRINGEMENTS.</p> <p>TO THE EXTENT PERMITTED BY LAW, THE EXCLUSIVE REMEDY OF THE USER OR BUYER, AND THE LIMIT OF SELLER'S LIABILITY FOR ANY AND ALL LOSSES, INJURIES, OR DAMAGES CONCERNING THE GOODS (INCLUDING CLAIMS BASED ON CONTRACT, NEGLIGENCE, TORT, STRICT LIABILITY OR OTHERWISE) SHALL BE THE RETURN OF GOODS TO SELLER AND THE REFUND OF THE PURCHASE PRICE, OR, AT THE OPTION OF SELLER, THE REPAIR OR REPLACEMENT OF THE GOODS. IN THE CASE OF SOFTWARE, SELLER WILL REPAIR OR REPLACE DEFECTIVE SOFTWARE OR IF UNABLE TO DO SO, WILL REFUND THE PURCHASE PRICE OF THE SOFTWARE. IN NO EVENT SHALL SELLER BE LIABLE FOR LOST PROFITS OR ANY SPECIAL, CONSEQUENTIAL OR INCIDENTAL DAMAGES. SELLER SHALL NOT BE RESPONSIBLE FOR INSTALLATION, DISMANTLING OR REINSTALLATION COSTS OR CHARGES. No Action, regardless of form, may be brought against Seller more than 12 months after a cause of action has accrued. The goods returned under warranty to Seller's factory shall be at Buyer's risk of loss, and will be returned, if at all, at Seller's risk of loss.</p> <p>Buyer and all users are deemed to have accepted this LIMITATION OF WARRANTY AND LIABILITY, which contains the complete and exclusive limited warranty of Seller. This LIMITATION OF WARRANTY AND LIABILITY may not be amended, modified or its terms waived, except by writing signed by an Officer of Seller.</p>
Service Policy	<p>Knowing that inoperative or defective instruments are as detrimental to TSI as they are to our customers, our service policy is designed to give prompt attention to any problems. If any malfunction is discovered, please contact your nearest sales office or representative, or call TSI's Customer Service department at 1-800-874-2811 (USA) or +001 (651) 490-2811 (International).</p>

Trademarks

AeroTrak and TRAKPRO are trademarks of TSI Incorporated. TSI and the TSI logo are registered trademarks of TSI Incorporated. Microsoft and Excel are registered trademarks of Microsoft Corporation. OpenOffice is a trademark of Sun Microsystems. Modbus® is a registered trademark of Modicon, Inc.

Contents

Manual History	ii
Warranty	iii
Safety Information	vii
Laser Safety	vii
Labels.....	viii
Description of Caution/Warning Symbols	ix
Caution.....	ix
Warning.....	ix
Caution or Warning Symbols.....	ix
Getting Help	x
CHAPTER 1 Introduction and Unpacking	1-1
Unpacking the AeroTrak [®] Handheld Airborne Particle Counter.....	1-2
Optional Accessories	1-3
CHAPTER 2 Getting Started	2-1
Instrument Description	2-1
Using the Instrument Stand and Stylus.....	2-2
Providing Power	2-3
To Install the Lithium-Ion Battery	2-3
To Use AC Power	2-4
Using with a Printer	2-4
Installing an Isokinetic Inlet	2-5
Installing a Temperature/Relative Humidity Probe	2-6
CHAPTER 3 Operation	3-1
Screen Layout and Functionality.....	3-1
Software Input Panel (Keyboard or Keypad).....	3-2
Main Tab.....	3-2
Setup Tab	3-6
Data Tab	3-27
Reports Tab.....	3-33
CHAPTER 4 Data Handling	4-1
USB Data Download	4-1
USB Computer Communication	4-2
Installing Software.....	4-2
Ethernet Communications.....	4-2
CHAPTER 5 Maintenance	5-1
Maintenance Schedule.....	5-1
Zero Check.....	5-1
Cleaning the Instrument Enclosure.....	5-1
CHAPTER 6 Troubleshooting	6-1

CHAPTER 7 Contacting Customer Service.....	7-1
Technical Contacts.....	7-1
International Contacts.....	7-1
Returning the AeroTrak® Handheld Airborne Particle Counter for Service.....	7-3
APPENDIX A Specifications	A-1
Temperature/RH Probe (700084) Specifications (optional accessory).....	A-2
Compliance	A-3
Dimensional Diagram.....	A-3

Index

Safety Information

This section gives instructions to promote safe and proper handling of the AeroTrak[®] Handheld Airborne Particle Counters.

IMPORTANT

There are no user-serviceable parts inside the instrument. Refer all repair and maintenance to a qualified factory-authorized technician. All maintenance and repair information in this manual is included for use by a qualified factory-authorized technician.

Laser Safety

- The Model 9306 Handheld Airborne Particle Counter is a Class I laser-based instrument.
- During normal operation, you will **not** be exposed to laser radiation.
- Precaution should be taken to avoid exposure to hazardous radiation in the form of intense, focused, visible light.
- Exposure to this light may cause blindness.

Take these precautions:

- **DO NOT** remove any parts from the particle counter unless you are specifically told to do so in this manual.
- **DO NOT** remove the housing or covers. There are no user-serviceable components inside the housing.









WARNING

The use of controls, adjustments, or procedures other than those specified in this manual may result in exposure to hazardous optical radiation.

Labels

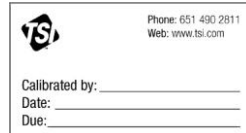
Advisory labels and identification labels are attached to the outside of the particle counter housing and to the optics housing on the inside of the instrument.

<p>1. Serial number label (back panel)</p>	 <p>AeroTrak APC 9306 – 03 Channels: .3/.5/.7/1/2/5um, 0.1CFM COMPLIES WITH 21 CFR 1040.10 AND 1040.11</p> <p>Manufactured : February 2011</p>  <p>*93061107008*</p> <p>12V  2.5A  </p> <p>TSI Incorporated www.tsi.com 500 Cardigan Road Shoreview, MN 55126, USA</p> <p>Made in USA</p>
<p>2. Laser radiation label (internal)</p>	<p style="text-align: center;">DANGER!</p> <p style="text-align: center;">VISIBLE LASER RADIATION WHEN OPEN. AVOID DIRECT EXPOSURE TO BEAM</p> <p style="text-align: center;">WARNING: NO USER SERVICABLE PARTS INSIDE. REFER SERVICING TO QUALIFIED PERSONNEL</p>
<p>3. Calibration Label (side panel)</p>	 <p>Phone: 651 490 2811 Web: www.tsi.com</p> <p>Calibrated by: _____ Date: _____ Due: _____</p>
<p>4. Laser radiation symbol label (internal)</p>	
<p>5. European symbol for non-disposable item. Item must be recycled.</p>	

Description of Caution/Warning Symbols

Appropriate caution/warning statements are used throughout the manual and on the instrument that require you to take cautionary measures when working with the instrument.

Caution



C a u t i o n
Failure to follow the procedures prescribed in this manual might result in irreparable equipment damage. Important information about the operation and maintenance of this instrument is included in this manual.





Warning



W A R N I N G
Warning means that unsafe use of the instrument could result in serious injury to you or cause damage to the instrument. Follow the procedures prescribed.

Caution or Warning Symbols

The following symbols may accompany cautions and warnings to indicate the nature and consequences of hazards:

	Warns that uninsulated voltage within the instrument may have sufficient magnitude to cause electric shock. Therefore, it is dangerous to make contact with any part inside the instrument.
	Warns that the instrument contains a laser and that important information about its safe operation and maintenance is included in the manual.
	Warns that the instrument is susceptible to electro-static dissipation (ESD) and ESD protection procedures should be followed to avoid damage.
	Indicates the connector is connected to earth ground and cabinet ground.

Getting Help

To obtain assistance with this product or to submit suggestions, please contact Customer Service:

TSI Incorporated
500 Cardigan Road
Shoreview, MN 55126 U.S.A.
Fax: (651) 490-3824 (USA)
Fax: 001 651 490 3824 (International)
Telephone: 1-800-874-2811 (USA) or (651) 490-2811
International: 001 651 490 2811
E-mail Address: answers@tsi.com
Web site: www.tsi.com

CHAPTER 1

Introduction and Unpacking

The AeroTrak® Model 9306 Airborne Particle Counter (particle counter) is a lightweight, handheld particle counter with a touch-screen interface. It operates on the included lithium-ion battery or AC power.

This device has a 0.1 CFM (2.83 L/min) flow rate and counts bin sizes from 0.3 to 25 µm that depend on the model ordered (see table below). Up to 10,000 data sets can be downloaded for analysis and reporting using the TrakPro™ Lite Secure Data Download Software included with the device.

Model	Size Range
9306-03	0.3, 0.5, 0.7, 1.0, 2.0, 5.0 µm
9306-04	0.3, 0.5, 1.0, 3.0, 5.0, 10.0 µm
9306-V2	0.3 to 10 µm, user-selectable; factory-calibrated at 0.3, 0.5, 1.0, 3.0, 5.0, 10.0 µm







Typical applications for this particle counter include clean room monitoring, research, exposure assessment, indoor air quality, filter testing, clearance testing, quality assurance, and contaminant migration studies. All AeroTrak® particle counters meet JIS standards.



(continued on next page)

Unpacking the AeroTrak® Handheld Airborne Particle Counter

Carefully unpack the AeroTrak® Airborne Particle Counter from the shipping container and verify that all the items shown in the photos below and listed in the following tables are present. Contact TSI immediately if items are missing or broken.

Model 9306 AeroTrak® Airborne Particle Counter Parts List

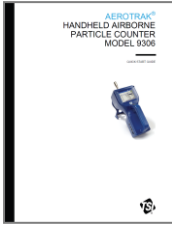

Qty.	Item Description	Part/Model	Reference Picture
1	AeroTrak® Airborne Particle Counter	9306-03 9306-04 9306-V2	
1	Power Supply with universal plugs	801694	
1	Isokinetic inlet	700003 AL	
1	Battery pack	700032	
1	Computer cable (2 m), USB A to B	700033	
1	Stylus	N/A	
1	HEPA zero filter assembly	700005	





Qty.	Item Description	Part/Model	Reference Picture
1	TrakPro™ Lite Secure Software CD for 21 CFR Part 11 compliant data downloading <i>(includes manuals)</i>	7001901	
1	Operation Manual	6004215	<i>Included on TrakPro™ Lite Secure Software CD</i>
1	Quick Start Guide	6004216	
1	Calibration certificate	N/A	

Optional Accessories

The following photos and table list optional accessories. If you ordered optional accessories, make certain they have been received and are in working order.

Model 9306 AeroTrak® Airborne Particle Counter Optional Accessories

Item Description	Part/Model	Reference Picture
External battery charger with AC adapter and power cord	700025	
External Printer	700085	
Carry case	700083	

Item Description	Part/Model	Reference Picture
Temperature/humidity probe	700084	
Stainless Steel Isokinetic inlet	700004	
Isokinetic probe (used with tubing)	700001 AL 700002 SS	
0.1 cfm Barb Inlet Fitting	700020	
Tubing, Superthane 1/8-inch ID x 1/4-inch OD, Clear 100 ft	700009	

CHAPTER 2

Getting Started

This chapter provides information to help you use the Model 9306 AeroTrak® Handheld Airborne Particle Counter including:

- [Instrument Description](#)
- [Using the Instrument Stand and Stylus](#)
- [Providing Power](#)
- [Installing an Isokinetic Inlet](#)
- [Installing a Temperature/Relative Humidity Probe](#)

Instrument Description

The Model 9306 has many features to make measurements convenient. They are described in detail below.



Using the Instrument Stand and Stylus

The Model 9306 is equipped with an integral instrument support stand. To open the stand, grasp it by the large finger hole and pull it out until it locks into place. Be careful not to overextend the stand. To store the stand out of the way when not in use, simply push the stand back until it snaps into place.



The Model 9306 is also equipped with a plastic stylus for use with the touch screen interface. The stylus locks into place in the case near the top of the unit when not in use.



Providing Power

The Model 9306 may be powered using a rechargeable lithium-ion battery, or through an AC power cord.

Notes:

- When using AC power, the battery (if installed) charges when the instrument is on, but not while actively sampling.
- Removing/changing the lithium-ion battery or disconnecting AC power does not cause loss of data.

To Install the Lithium-Ion Battery

1. Remove the battery cover from the back of the instrument by lightly depressing the textured tab on the cover located on the lower left.

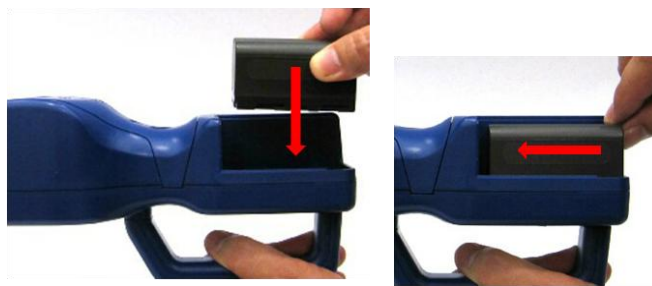

2. Place the lithium-ion battery into the battery compartment and slide it forward (toward the top of the unit) until it locks into place.
3. Replace the battery cover and slide it in place until you hear a click.



W A R N I N G

The battery supplied by TSI (PN 700032) has built in protection against explosion and fire hazard. Do **not** use a substitute.



W A R N I N G

Do **not** use non-rechargeable batteries in this instrument. Fire, explosions, injury or other hazards may result.

To Use AC Power

1. Connect the AC power adapter to the power cord.
2. Insert the AC power adapter into the side of the Model 9306.
3. Connect the power cord to an outlet.
4. Press the on/off button  (located on the front of the instrument handle).
5. After a splash screen displays the TSI logo, a brief start-up sequence begins as the Windows® CE operating system boots up.

Using with a Printer

A hard copy of a sample set can be printed from the instrument using the optional TSI Model 700085 thermal printer (see Chapter 3, [“Operation”](#)). Only the TSI Model 700085 printer is compatible with the Model 9306. The printer may be used on its internal battery or an AC adapter. A custom communications cable is included with the printer. The cable goes between the USB A port and the 9 pin DSUB on the printer.



Installing an Isokinetic Inlet

The Isokinetic inlet smoothly accelerates air into the inlet of the instrument. To install, simply thread the inlet directly onto the inlet nozzle until finger tight. The inlet seals over an O-ring so it doesn't have to be very tight to seal.



Installing a Temperature/Relative Humidity Probe

To install the optional temperature/relative humidity probe:

1. Align the probe so the pins slide into the sockets of the base connector.
2. Align the locking collar on the probe so it will slide over the alignment pins on the base connector
3. Press down and turn the locking collar to lock in the probe.
4. Temperature and relative humidity are automatically displayed in the upper-left corner.
5. Remove the probe turned the locking collar and then pulling straight up on the probe.



CHAPTER 3

Operation

The Model 9306 AeroTrak[®] Handheld Airborne Particle Counter is controlled using a touch screen display. Use the plastic stylus or your finger tip. **DO NOT** use sharp objects (such as a pen point) that may damage the screen overlay.

To turn on the instrument, press the **on/off** button (located in the center of the front of the instrument). After a splash screen displays the TSI logo, a brief start-up sequence begins as the Windows[®] CE operating system boots up.

The instrument is ready for operation when the main tab (shown below) appears. If an optional temperature/humidity probe is attached, those values will be shown in the upper-left corner also.

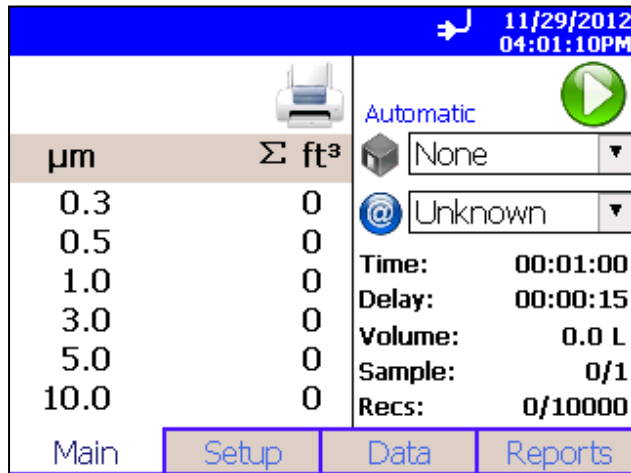

Screen Layout and Functionality

There are four main screens (tabs): Main, Setup, Data, and Reports. The operation of each of these screens, the information displayed on them, and the operations you can perform from each are described in the remainder of this chapter.

Some screens require or allow you to enter information. To enter information, tap on the screen and an on-screen keyboard appears.

Software Input Panel (Keyboard or Keypad)

1. Throughout the setup screens, a keyboard or keypad appears on the screen when text or numbers may be entered.
2. When you enter information using the keyboard, press either the ↵ (Enter) or Esc keys when you are done. When you enter data using the keypad, the data is entered when you press **OK** on the screen. The keyboard will then be hidden until another text entry box is selected.

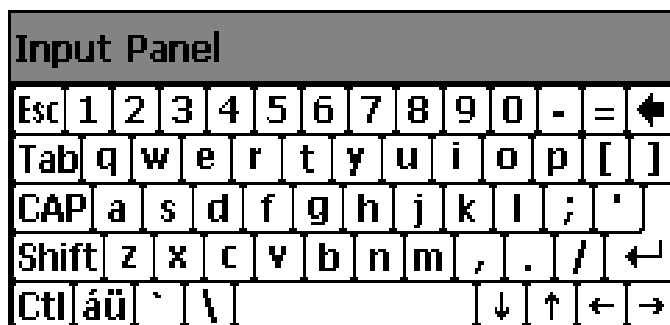

3. When numeric input is required, a numeric keypad will appear on the screen in place of the full keyboard.

Main Tab









The Main Tab is the default screen. The left side of the screen summarizes the concentrations for the currently selected location. Tap on the size and count portion of the screen to enable Zoomed Data Screen (see [Setup Tab](#)).

The display shows:

- Temperature*
- Relative humidity*
- Bin sizes
- Particle count/concentration



The status bar at the top of the screen shows the current time and date (see the [Setup Tab](#)) and indicates:





*Temperature and Humidity are displayed only if the optional T/H probe is installed.

Icon	Description
	Instrument status error. If this icon is shown, it can be pressed and a more detailed description of the operational error will be shown. Refer to the troubleshooting section for appropriate actions.
	Sufficient flow through the instrument. NOTE: During Start Delay (Delay) and Hold Times (Hold), this is only an indicator of flow On. During Sample Time (Time), this is an indicator of flow within specified tolerances.
	Insufficient flow through the instrument. If this icon is shown, it can be pressed and a more detailed description of the flow error will be shown. Refer to the trouble shooting section for appropriate actions. NOTE: During Start Delay (Delay) and Hold Times (Hold), this is an indicator of flow Off. During Sample Time (Time), this is an indicator of flow not being within specified tolerances.
	Operating on AC power, no battery installed
	Operating on AC power, battery is installed and charging. (The battery charges when the instrument is on but not actively taking a particle sample.)
	Battery charged
	Low battery
	Battery is very low!
	Indicates that TrakPro Lite Secure software is interfacing with the AeroTrak particle counter. The front panel GUI is inoperable when the software is operational. Once the software is exited, normal front panel operation will resume.

Press and hold the  (Zone) icon to display a summary of information for the current Zone.

Tap the  (Location) icon to step through the list of Locations for the Zone.

μm	$\Sigma \text{ ft}^3$	Automatic	
0.3	0	 None	
0.5	0	 Unknown	
1.0	0	Time: 00:01:00	
3.0	0	Delay: 00:00:15	
5.0	0	Volume: 0.0 L	
10.0	0	Sample: 0/1	
		Recs: 0/10000	
Main	Setup	Data	Reports

Field	Description
 (Zone)	Displays the Zone where the sample is being taken by the instrument. Press the icon to display a summary of information for the Zone.
 (Location)	This dropdown box allows selection of a preconfigured Location to associate the sampled data to.
Time	The time for each sample.
Delay	<p>The Delay displays one of two times:</p> <ol style="list-style-type: none"> 1. Before the Start button is pressed the Start Delay time is displayed and then immediately after the Start button is press the delay time begins a countdown. 2. During sampling and between cycles (after the Start Delay has been displayed), the Hold Delay is displayed and then begins a countdown.
Recs	The total number of records in the database/10000 (maximum number of records).
Manual/Automatic/Beep	Mode Indicator; refers to the “Data Count Mode” (see section below).
	Start/Stop button to begin and end sampling in the configured mode. Start/Stop may also be entered using the triangle-shaped button above the power button on the front of the instrument.
	Press to print the current sample to the optional printer.



Zoomed Data Screen

The Zoomed Data screen is entered by touching in the size and count part of the main tab display. The bottom portion of the screen summarizes the concentrations for the currently selected location. Tap the size and count portion of the display to switch back to the Main Tab display.

The display shows:

- Temperature*
- Relative humidity*
- Bin sizes
- Particle count/concentration

Sampling		5/3/2010 1:20:43 PM
28.0 50 %RH	Loc001 Automatic	
μm	Σ	
0.3	362	
0.5	177	
1.0	73	
3.0	24	
5.0	7	
10.0	4	

Field	Description
Location	Label that displays information about the currently selected location.
Manual/Automatic/Beep	Mode Indicator; refers to the "Data Count Mode" (see section below).
 	Press the Start/Stop button the begin sampling in the configured mode.

*Temperature and Humidity are displayed only if the optional T/H probe is installed.

Setup Tab

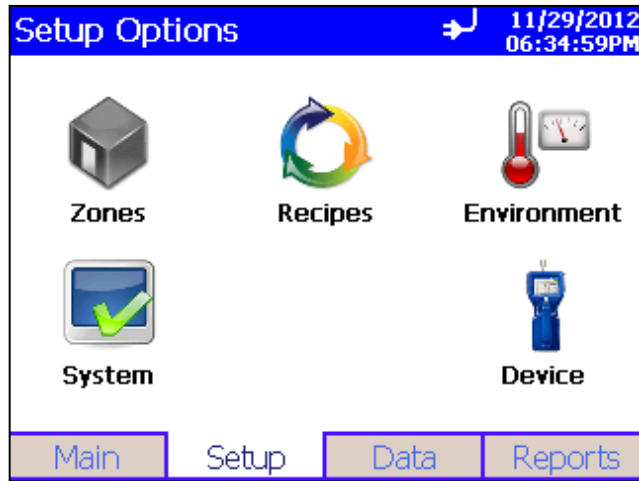

The setup tab provides access to the following:

Zones Setup	Identify and save the location information associated with collected samples.
Recipes Setup	Save a group of settings (a Recipe) that you use over and over so you do not have to reset individual settings.
Environment Setup	Sets which units are preferred for displaying environmental measurements taken using optional measurement probes.
System Setup	Change Power On Password, Setup Password, System Configuration, Print Settings, Print Schedule and Clear Samples
Device Setup	Set Date and Time, Screen Alignment, Communications, Regional Settings, and get device information.

Zone Setup Screen

"Zones" are a convenient way to group sample data for printing and export, and are required for creating standards-based classification reports. A Zone contains 1 or more "Locations"; this is modeled after cleanroom standards that prescribe the classification of a zone (or room) by taking samples at various locations within the zone.

Use the Zone Setup screen to add, delete or edit Zone configurations.

The screenshot shows a software interface titled "Zones" with a blue header bar. In the top right corner, there is a mouse cursor icon, the date "11/29/2012", and the time "06:30:12PM". On the left side, a list box contains "Zone 1" which is highlighted. To the right of this list box, the configuration details for "Zone 1" are displayed: Name: Zone 1, Standard: ISO 14644-1, Class: 7, Status: At Rest, Air Flow: Unidirectional, Area: 9 m², Locations: 3, and Recipe: Z1 Recipe. Below the configuration details, the text "1/250 Zones, 3/999 Locations" is shown. At the bottom of the screen, there are four buttons: "Delete", "Add", "Edit", and "Close".

The Zone configuration screen provides the following information for each zone that is configured.

Field	Description
Zone Name	The name to assign to the Zone.
Standard	The classification standard to use for the samples taken in the Zone. Options include ISO 14644-1, EU-GMP, Fed Std 209E F, Fed Std 209E, and None. Use "None" for taking measurements that are not associated with standards classification.
Class	The Class selected for the classification of the Zone. Options vary by the Standard selected.
Status	The occupancy status of the Zone. Options vary based on the selected standard, but include <i>At Rest</i> , <i>Operational</i> and <i>As Built</i> .
Air Flow	The direction of air flow through the Zone. Options are Unidirectional or Multidirectional.
Area	The area of the Zone in ft ² or m ² .
Largest Particle Size to Consider	The largest particle size to consider for classification measurements. Used by most standards to calculate minimum required sample volume.
Locations	The Locations defined within the Zone.
Recipe	The Recipe assigned to the Zone.

To Delete A Zone

To delete a zone from the configuration screen, select (highlight) the zone name and press **Delete**. A verification message "Are you sure you want to delete this Zone?" appears. Press **Yes** to delete the zone.

A zone that has data associated with it cannot be deleted. The data associated with the zone must be deleted from the instrument before the zone can be deleted.

To Add a Zone

To add a zone, press **Add**. The Definition Screen is displayed.

1. Enter a name for the zone and select the Standard, Class, Status, Airflow and Largest Particle Size to Consider options from the dropdown boxes. Input the Area using the keypad and select either ft² or m² to describe the area of the zone.

Definition	Locations	Recipe
Zone Name	z1	Area
Standard	ISO 14644-1	9.0
Class	7	<input type="radio"/> ft ² <input checked="" type="radio"/> m ²
Status	At Rest	3/3 required Locations defined
Air Flow	Unidirectional	
Largest Particle Size to Consider	5.0	

Save Save New Zone Cancel

2. Press the **Locations** tab. The Locations screen is displayed.

Definition	Locations	Recipe
	Location01 Location02 Location03	Edit Name Location03
		Add Auto
		Rename Move Up
		Remove Move Down

3/3 required Locations defined

Save Save New Zone Cancel

3. Enter names for each location in the zone and the press Add after entering each. The name will be added to the box on the left side of the screen.
4. Press the **Recipe** tab. The Recipe screen is displayed with a default recipe in the “Selected Recipe” field.
5. Select the recipe you want to use from the “Selected Recipe” field or press **Create Recipe** to create a new recipe or **Edit Recipe** to edit the recipe shown in the “Selected Recipe” field.

See [Recipes Setup Screen](#) in the **Setup** section for information about the fields and parameters of the recipe tabs (Recipe, Timing, Channels T and Channels V).

NOTE #1: You can also create recipes from the **Setup Tab** by selecting the **Recipe** icon , but if you create a new recipe here, information you have already entered for the zone is prepopulated into the required fields.

NOTE #2: If you edit an existing recipe, your changes will affect all zones using that recipe. Be certain that is what you want to do.

6. When you are done selecting the recipe to use or adding a new recipe or editing an existing recipe, press **Save** or **Save New Zone**.

To Edit A Zone

1. To edit an existing zone configuration, press **Edit**. The following screen is displayed.

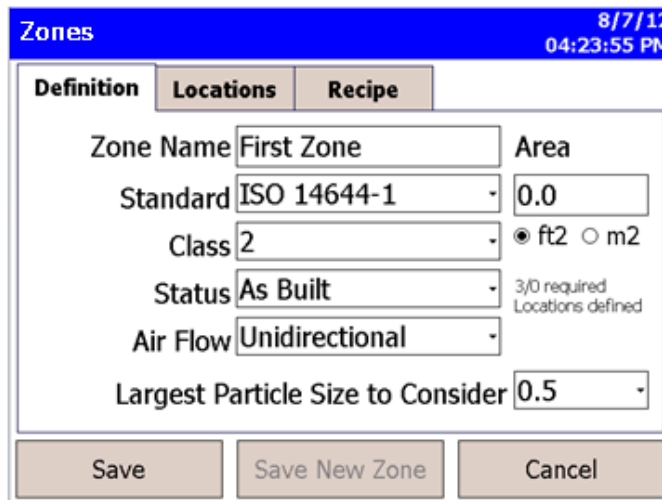

The screenshot shows a mobile application interface titled "Zones" with a date and time of 8/7/12 04:23:55 PM. It features three tabs: "Definition", "Locations", and "Recipe". The "Definition" tab is active, displaying the following fields:

- Zone Name: First Zone
- Area: 0.0
- Standard: ISO 14644-1
- Class: 2
- Status: As Built (with a note: 3/0 required Locations defined)
- Air Flow: Unidirectional
- Largest Particle Size to Consider: 0.5

At the bottom, there are three buttons: "Save", "Save New Zone", and "Cancel".

2. The display has three tabs: **Definition**, **Locations**, and **Recipe**. Select the tab for the information you want to edit.
3. The **Definition** screen for each zone provides the same information as displayed on the main Zone Configuration screen with the addition of “Largest Particle Size to Consider” field.

- The **Locations** screen displays the locations within the selected zone. You can add, rename, or remove a location from the zone. You can also move the location name up or down in the list. The Auto feature will generate the number of locations required by the chosen standard. This utilizes the room area entered in the zone definition. The locations can then be renamed or the default naming convention can be maintained.

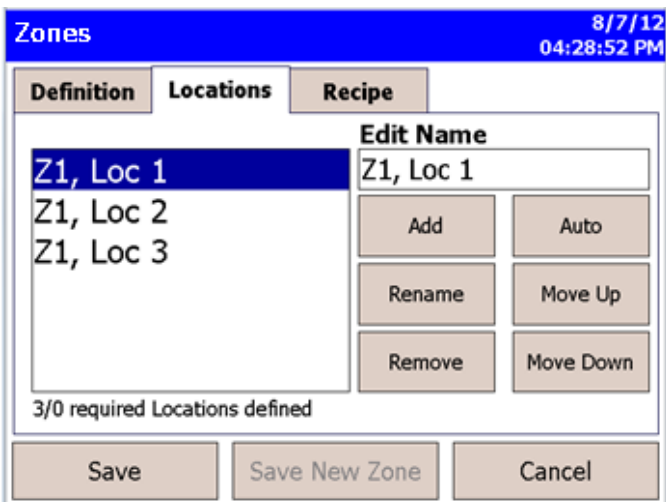

- The **Recipe** screen displays the recipe in use for the selected zone and information relevant to that recipe. You can select a different recipe for the zone or you can create a new recipe or edit an existing recipe. (For information about recipes see the **Recipes** section in **Setup**.)

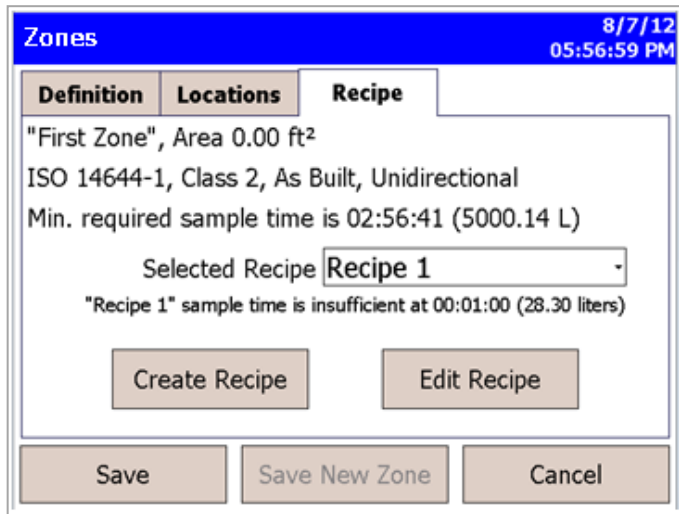

Note

If you edit a recipe, the changes will affect all zones using that recipe. Be certain that is what you want to do.

- When you have made all the changes, press **Save**.

Recipes Setup Screen

Use the Recipes Setup Screen to review recipes, add or delete recipes, and edit recipes. You cannot delete the "Default" recipe. A recipe that has samples cannot be deleted.

NOTE: The delete button will be grayed out and unavailable if the recipe has samples.

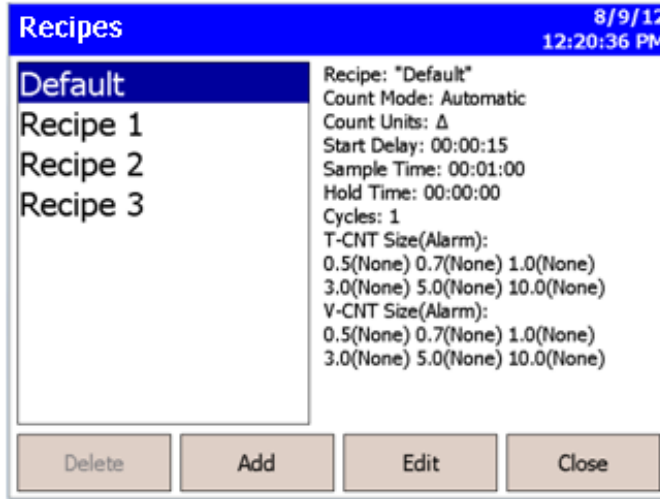

The screenshot shows a window titled "Recipes" with a blue header bar. The top right corner displays the date "8/9/12" and time "12:20:36 PM". On the left, a list of recipes is shown: "Default", "Recipe 1", "Recipe 2", and "Recipe 3". The "Default" recipe is selected. To the right of the list, the details for the selected recipe are displayed: "Recipe: 'Default'", "Count Mode: Automatic", "Count Units: Δ", "Start Delay: 00:00:15", "Sample Time: 00:01:00", "Hold Time: 00:00:00", "Cycles: 1", "T-CNT Size(Alarm): 0.5(None) 0.7(None) 1.0(None) 3.0(None) 5.0(None) 10.0(None)", and "V-CNT Size(Alarm): 0.5(None) 0.7(None) 1.0(None) 3.0(None) 5.0(None) 10.0(None)". At the bottom of the window, there are four buttons: "Delete", "Add", "Edit", and "Close".

The steps for adding or editing a recipe are identical. Press either the **Add** button or the **Edit** button and proceed as follows:

1. Press **Add** or **Edit** button to display the Recipe Tab.

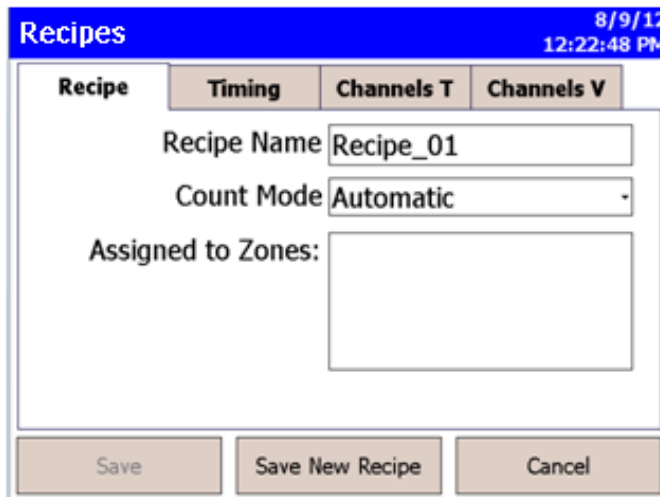

The screenshot shows the "Recipes" window with the "Recipe" tab selected. The top right corner displays the date "8/9/12" and time "12:22:48 PM". The window has four tabs: "Recipe", "Timing", "Channels T", and "Channels V". The "Recipe" tab is active. It contains the following fields: "Recipe Name" with the value "Recipe_01", "Count Mode" with a dropdown menu set to "Automatic", and "Assigned to Zones:" with an empty text area. At the bottom of the window, there are three buttons: "Save", "Save New Recipe", and "Cancel".

2. On the **Recipe** tab, enter a name or edit the name of the recipe. For a new recipe, a default name will appear, but you can type over it and name the recipe anything you want.

3. Select the Count Mode: options are Automatic, Manual, and Beep as described below.

Field	Description
Automatic	If this mode is selected, the particle counter starts counting in automatic mode when the start button is pressed according to the settings on the Recipes Timing Screen .
Manual	If this mode is selected, the particle counter starts sampling immediately when the start button is pressed and stops at the end of the sample time, which is configured on the Recipes Timing Screen .
Beep	<p>The Beep mode enables the AeroTrak particle counter to operate in a “Geiger Counter” mode. As particles are detected, a beep is emitted. The frequency of beeps configured utilizing the alarm thresholds setting. It works on a single bin. If you wish to beep on total particulates, configure the unit in cumulative mode and set an alarm threshold for the .5 channel. The alarm threshold determines the beep frequency. The actual number of particulates measured in the preceding 1 second will be divided by the threshold and the corresponding number of beeps emitted. An alarm threshold of 0 will not emit beeps.</p> <p>To alarm on viable particulates, be sure that all total particulate alarms are disabled and configure an alarm in the viable count channels. It is configured in the same manner described above.</p> <p>If multiple alarms are configured, the AeroTrak will emit beeps only on a single channel. If multiple alarms are configured, the AeroTrak searches for which alarm to operating on starting with the smallest to largest Total Particulate Channel selected followed by the smallest to largest Viable Particulate Channel.</p> <p>Settings in the sample timing screen are ignored in beep mode.</p> <p>Example: Looking for a viable particle source that raises above 500 count background by 10000. Configure the unit in cumulative mode and enable the .5 viable particulate alarm to 500. The AeroTrak will now emit a single beep for every 500 particles. At steady state, a beep will be emitted once per second ($500/500=1$). When the source is encountered it will emit 20 beeps per second ($10,000/500 = 20$). If a higher frequency is desired lower the threshold to 200. This will result in 50 beeps per second being emitted.</p> <p>The maximum number of beeps that can be emitted per second is 50.</p>

4. Finally, enter the zones that this recipe is or will be assigned to.

NOTE: Entering the names of the zones in this box does not assign this recipe to the zone. This is for information only. So when you change the recipe for a zone, update the information here.

- Press the **Timing** tab to enter or edit start delay times, sample time, hold time, etc.

Zones 11/29/2012 06:28:08PM

Recipe **Timing** **Channels**

Start Delay 00 : 00 : 15

Sample Time 00 : 02 : 25

Hold Time 00 : 00 : 00

Cycles 1

Volume 6.8391667

ft³ m³ liters

Save Save New Recipe Cancel

- To make changes to the timing settings, highlight the component to change (hours, minutes, seconds, etc.) and use the on-screen keypad to change the value.



WARNING

Instrument status alarms are inactive if samples times are 10 seconds or less. Flow error alarms may not occur if sample time is less than 10 seconds. To ensure proper instrument status and flow alarm operation, utilize a sample time of 15 seconds or larger.

Field	Description
Start Delay 	Start Delay indicates how long it will be before the first sample is taken. NOTE: It takes approximately 10 seconds for the pump to reach the flow set point; taking a measurement before the pump is functioning properly may result in a data and flow error.
Sample Time	Sample time indicates how long the instrument will run for each sample.
Hold Time	Hold Time indicates how long the instrument pauses between samples.
Cycles	Cycles is the total number of samples you want to collect. In Automatic mode, a cycle value of ∞ causes the instrument to count continuously using the settings for Sample, Time, and Hold Time until the Start/Stop button is pressed again.
Volume	Volume sets the volume of air that will pass through the instrument for each sample. Select the volume unit, then enter a volume value. The Sample Time will be updated automatically to the nearest second adequate to provide the desired volume .

- Press the **Channels** tab.

Zones 11/29/2012
06:28:42PM

Recipe		Timing	Channels
Enable	Size	Alarm	Threshold
<input type="checkbox"/>	0.3	<input type="checkbox"/>	1020000
<input checked="" type="checkbox"/>	0.5	<input checked="" type="checkbox"/>	352000
<input checked="" type="checkbox"/>	1.0	<input checked="" type="checkbox"/>	83200
<input type="checkbox"/>	3.0	<input type="checkbox"/>	8460
<input checked="" type="checkbox"/>	5.0	<input checked="" type="checkbox"/>	2930
<input type="checkbox"/>	10.0	<input type="checkbox"/>	692

Count Units: Σ #/m³ ▼

Save Save New Recipe Cancel

- This tab can be used to view or set the particle size for each channel (not supported in all models), enable/disable the channel, enable/disable alarm for each channel and set the alarm threshold for each channel. The threshold values are expressed in the units selected in the Count Units control. Select the appropriate Count Units from the list.

During sampling, when a channel value exceeds the threshold value set here, the channel data is highlighted in red on the Main screen, an audible alarm sounds, and the alarm icon.

To acknowledge the alarm and silence the buzzer, tap the alarm icon .

Notes

In **Differential modes** (Δ), disabling one or more channels will disable all threshold alarms. Other alarms are not affected.

While in **beep mode**, a threshold of 0 will not trigger an audible alarm even if Alarm is enabled.

Concentration display is unavailable in Beep mode.

- Press **Save** or **Save New Recipe** as appropriate when done.

Note

The **Channel Configuration** screen has restrictions that must be noted when **Differential mode** (Δ) is selected.

When **differential Δ particle count or concentration** is selected, the total number of counts is the number of particles *between* enabled bin sizes. When particle concentration is cumulative Σ , the total number of counts includes all particles larger than the bin size.

In **Differential Display/Alarm** mode, there are two constraints:

- If alarming is desired, *all* channels must be *enabled*.
- If channel selection is desired, then *all* alarms must be *disabled*.

The controls work in a mutually exclusive manner. When any of the channel "Enable" boxes are unchecked, all "Alarm" enable boxes will be cleared. When any of the "Alarm" boxes are checked, all of the channel "Enable" boxes will become checked.

For the **Cumulative** modes (Σ), there are no such constraints. Any combination of "Enable" and "Alarm" selections can be made.

System Setup Screen

Use the System Setup screen to select (or change) the power on password, set up a password, select system configuration parameters, select print settings, schedule printing and clear samples.



Change Power On Password Screen

If a Power On password has been previously set, that password must be entered before being allowed to change the Power On password. If a Power On password is set, then on instrument startup a password screen will ask for the password before the instrument can be used. A blank password is regarded as no password and if set as the new password, will not prompt you for a password on system startup.

Note

Keep the password in a safe place. It is difficult to reset the password and requires contacting the factory. If the password has been misplaced, please contact TSI technical support.

Tap on the screen to display the on-screen keyboard and enter the required information.

Field	Description
Old Password	Enter your existing password (if one has already been set) or leave blank.
New Password	Enter a new password. The password can be any length and use any characters.
Confirm New Password	Retype the new password then press OK. A confirmation message appears if the password is changed.

Note

Leave both New Password and Confirm New Password fields blank to turn off password protection.

Call TSI if you have forgotten the password.

Change Setup Password Screen

If a Setup password has been previously set, that password must be entered before being allowed to change the Setup password. If a Setup password is set, clicking on the setup tab at the bottom of the main screen brings up a password screen. That password must be entered in order to change instrument settings.

Tap on the screen to display the on-screen keyboard and enter the required information.

Field	Description
Old Password	Enter your existing password (if one has already been set) or leave blank.
New Password	Enter a new password. The password can be any length and use any characters.
Confirm New Password	Retype the new password then press OK. A confirmation message appears if the password is changed.

Note
<p>Leave both New Password and Confirm New Password fields blank to turn off password protection.</p> <p>Call TSI if you have forgotten the password.</p>

Configuration Screen

Use the Configuration screens to set configuration parameters. Press **OK** when finished.

The screenshot shows a configuration window titled "Configuration" with a blue header. In the top right corner, the date "11/30/2012" and time "05:40:16PM" are displayed. The main content area is labeled "System" and contains two unchecked checkboxes: " Δ and Σ on Zoom" and " Store Partial Samples". Below these is a text input field for "Particle Density (g/cm³)" with the value "2.5" entered. To the right of the input fields is a gear icon. At the bottom right, there are two buttons: "OK" and "Cancel".

Field	Description
Δ and Σ on Zoom	Select to zoom in on both cumulative (Σ) and differential (Δ) counts on the Main Tab. To zoom the Main Tab, select on the left side of the Main Tab. (It takes a moment for the screen to update.) Click on the screen again to return to normal view.
Store Partial Samples	When selected, stores the partial record in the current database if the instrument is stopped during a sampling period.
Alarm Volume Level	Controls the alarm volume setting.
Particle Density	Enter the particle density value that will be used to calculate mass concentrations for display, print and export of sample data.

Print Setup Screen

A hard copy of a sample set or statistics can be printed from the instrument using an optional thermal printer. Use this screen to set print parameters. Press **OK** when finished.

Print Setup		10/29/2012 02:31:28 PM
<input checked="" type="checkbox"/> Serial Number		<input type="button" value="OK"/> <input type="button" value="Cancel"/>
<input checked="" type="checkbox"/> Model Name		
<input checked="" type="checkbox"/> Separator		
<input type="checkbox"/> Differential		
<input checked="" type="checkbox"/> Cumulative		
<input type="checkbox"/> Last Calibration		

Field	Description
Serial Number	Indicates that the serial number of the particle counter used to collect the data will be printed.
Model Name	Indicates that the model number of the particle counter used to collect the data will be printed.
Separator	Indicates a line separator will be printed after the Model Name and Serial Number in the header of all printouts
Differential	Indicates that the differential value of the data will be printed.
Cumulative	Indicates that the cumulative value of the data will be printed.
Last Calibration	The date and time the instrument was last calibrated by TSI.

Note
Printer paper has a colored strip printed on the last few feet of each roll to indicate when it is time to change the paper roll.

Print Schedule Screen

Use the Print Schedule screen to schedule automatic printing. You can choose to either print when an alarm occurs or print whenever a sample is complete.



Field	Description
Automatic Printing	Enables automatic printing when checked.
On Sample	Print data whenever a sample completes.
On Alarm	Print data when an alarm condition occurs.

Clear Samples Screen

Use the Clear Samples screen to clear all samples from the internal database. Select **Yes** to clear all samples. Select **No** to return to the System Setup screen.

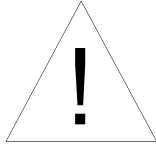

CAUTION	
WHEN "YES" IS SELECTED ON THE CLEAR SAMPLES SCREEN, ALL SAMPLE RECORDS WILL BE DELETED FROM THE INSTRUMENT! THERE IS NO WAY TO RECOVER THEM ONCE THEY HAVE BEEN DELETED.	

Clear Samples 11/30/2012 05:42:31PM

Are you sure you wish to clear all samples?

Yes

No

Device Setup Screen

Use the Device Setup screen to access screens that let you set or change the date and time, set visual parameters of the display, set up communications, set regional features, and get system information such as software version, etc.

Device Setup 11/29/2012 06:35:46PM

Date and Time

Display

Information

Communication

Regional

Back

Date and Time Screen

Use the Date and Time screen to set the current date and time and set the date format. Press **OK** when finished. Select options using the arrows or tapping on the screen which brings up the keypad.

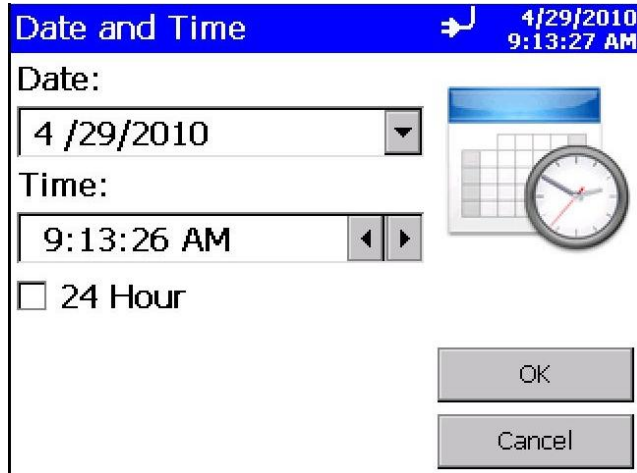

Field	Description
Date	Press the down arrow to display a calendar then select the date from the calendar.
Time	Select the time component you want to change (hours; minutes; seconds) and then use the left and right arrows to adjust to the current time.
24 Hour	Time display is in 24 hour format when checked.

Display Screen

Use the Display screen to set or change visual parameters.



Field	Description
Screen Alignment	<p>Press this item to reset the screen alignment. Follow the directions on the alignment screen.</p> <p style="text-align: center;">NOTE:</p> <p>The touchscreen display is aligned at the factory and typically will stay aligned for the life of the instrument. Only perform this alignment if tapping on the onscreen controls of the instrument seems to give poor results.</p>

Information Screen

Use the Information screen to view the system's model, serial number, copyright, manufacture date, calibration date, next calibration date, firmware version, USB IP address and date and time format. Press **Close** when finished.

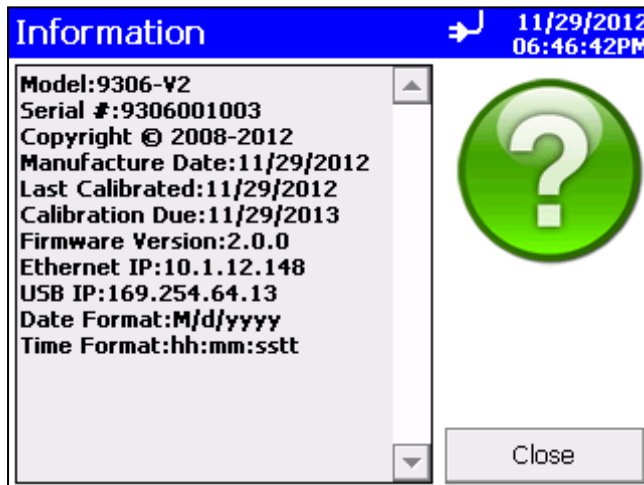

Communication Screen

Use the Communication screen to configure the IP address, subnet, and default gateway to which the instrument belongs. Addresses can be entered using the arrows or by selecting a field and using the on-screen keypad.

Field	Description
IP Address	The numerical identification (logical address) that is assigned to this device when participating in a computer network utilizing the Internet Protocol for communication between its nodes.
Subnet Mask	A network of computers and devices that have a common, designated IP address routing prefix. All hosts within a subnet can be reached in one "hop" (time to live = 1), implying that all hosts in a subnet are connected to the same link.
Default Gateway	A node on the computer network that serves as an access point to another network and is chosen when the IP address does not belong to any other entities in the Routing Table.
Use DHCP (Dynamic Host Configuration Protocol)	When checked, this protocol is used to automatically obtain the information necessary for operation from a DHCP server running on your local network.

Note
TCP/IP is an industry standard networking protocol that allows computers and devices to communicate over Ethernet and other media access channels. Providing full details on how to configure an IP network is beyond the scope of this manual. Please contact your company IT department or a qualified networking professional if you are not qualified to configure such a network.

Regional Screen

Use the Regional screen to set the language in which the on-screen dialog is displayed and your regional format for numbers.



Field	Description
Language	Select the language in which you want on-screen dialog displayed; options are German, English, Spanish, French, Italian, Chinese, and Japanese.
Formats	Select the format that is commonly used to display real numbers and the date and time in your region.

Environment Screen

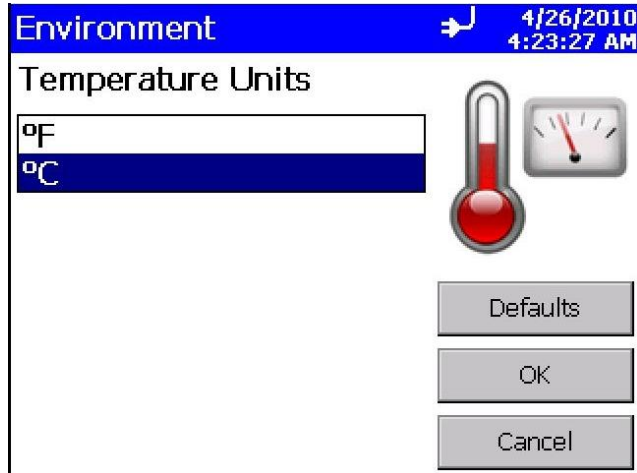

Use the Environment screen to set the units for temperature, which is displayed on the Main and Data Tabs, and the printouts when a humidity and temperature probe is hooked up to the instrument.



Field	Description
°F	Display temperature in degrees Fahrenheit.
°C	Display temperature in degrees Celsius.



Data Tab

Use the Data tab to preview data that has been collected. To scroll through the records, use the elevator (slide) on the right. The record number is displayed at the bottom of the tab. As each record displays, its data and relevant parameters are displayed.

Data				11/30/2012 11:48:47AM
m ³	Size	Δ #/m ³	Σ #/m ³	▲
	0.3	23980	28951	
	0.5	4240	4971	
	1.0	439	731	
	3.0	0	292	
	5.0	146	292	
	10.0	146	146	
Z:Zone 1 t2		Date: 11/30/2012		
L:Location03		Time: 11:44:22AM		
Sample:	00:02:25	Vol: 6.84L	Alarm: No	
Flow:	OK	Inst: OK		
Record:	8	Records:	8 / 10000	
Main		Setup		Data
				Reports

Note

Counts displayed on the data tab concentration may have slight rounding errors when comparing all channels to values with selected channels enabled. The method for calculating concentration is to sum the raw counts for each location, calculate concentration from sample volume and then round. This may result in slight rounding errors when comparing counts with all channels enabled versus concentrations with selected channels enabled. The methodology utilized is covered in ISO 14644-1 Annex D.

Field	Description
#, ft ³ , m ³ , μ g	Button used to change between counts and concentration displays: # = number ft ³ = particles per cubic foot m ³ = particles per cubic meter μ g = micrograms per cubic meter (mass concentration)
Size	Channel size.
Δ	Differential mode.
Σ	Cumulative mode.
	Export the data to a flash drive. See Export Data Screen below.
	Print data to the optional printer. See Print Data below
Zone (Z)	Zone where the data was collected.
Location (L)	Location where the data was collected.
Sample	Duration of the sampling period.

Field	Description
Date	Date on which the data was collected.
Time	Time at which data was collected.
Temperature	Temperature at the end of the time the data was collected (if probe connected during sampling).
Humidity	Humidity level at the end of the time the data was collected (if probe connected during sampling).
Flow	Status of the flow. Options are: OK or ALRM. OK indicates the flow rate is good; ALRM indicates flow rate is below the defined setting.
Alarm	Alarm threshold was triggered (Yes) or not (No).
Inst	Status of the instrument hardware. OK if no issues; SRVC if instrument has a possible issue.
Vol	Volume of air that was sampled.
Record	This record number.
Records	Total number of records.

Export Data Screen

Use the Export Data screen to export sample data to a flash drive. Select the name of the file and range of data to export. Data is downloaded into an XML file that can be opened with commonly used spreadsheet programs.

To Export Data

1. Click the USB drive icon on the Data tab. The Export Data screen appears.

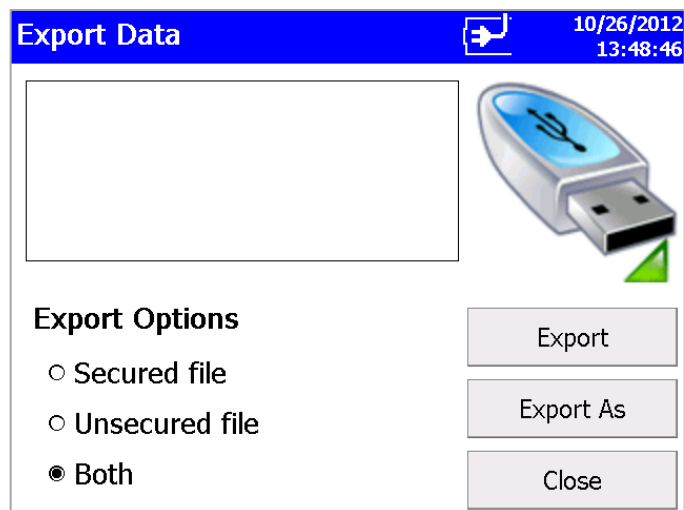

Field	Description
Secured file	This file is intended to be used with TrakPro Lite Secure software and maintains CFR 21 Part 11 compliance. The file has the extension file name_sec.xml .
Unsecured file	This file is intended for user input into Excel for graphing and data manipulation purposes and has the extension file name.xml .
Both	If using both file types, both file formats can be exported. Please note that the data export time is longer when both file formats are exported.



Caution
Do NOT modify the secure file. If the “_SEC” secure file is modified, TrakPro Lite Secure software will not be able to open the file.

2. Select a file from the list and click:
 - a. “Export” to overwrite an existing file selected from the file list.
 - b. “Export As...” to enter a file name. Then select **OK**.

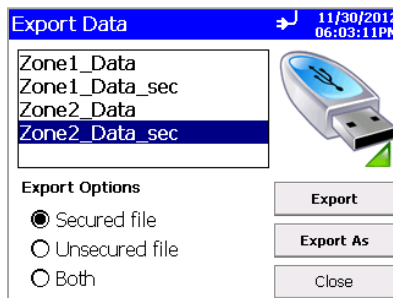

a

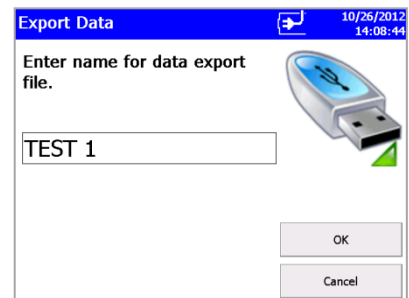

b

3. Select Sample data by Zone or by Sample index range.

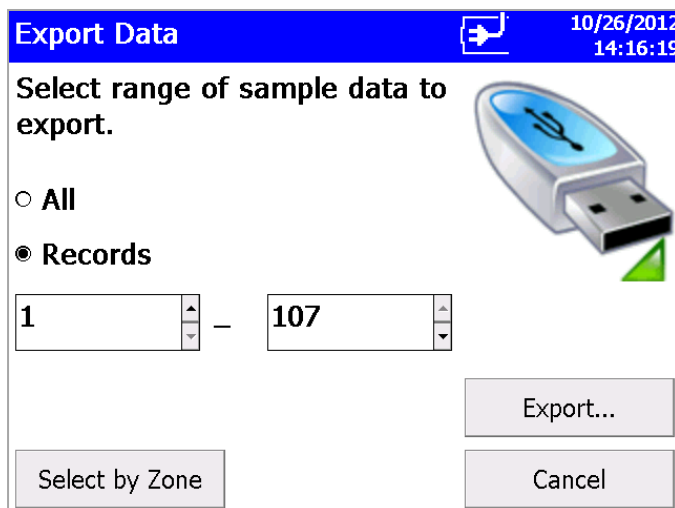

4. Once the records or the Zones have been selected, press **Export...** to begin exporting. Status screens allow viewing the progress of the export.



or

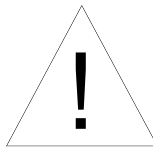
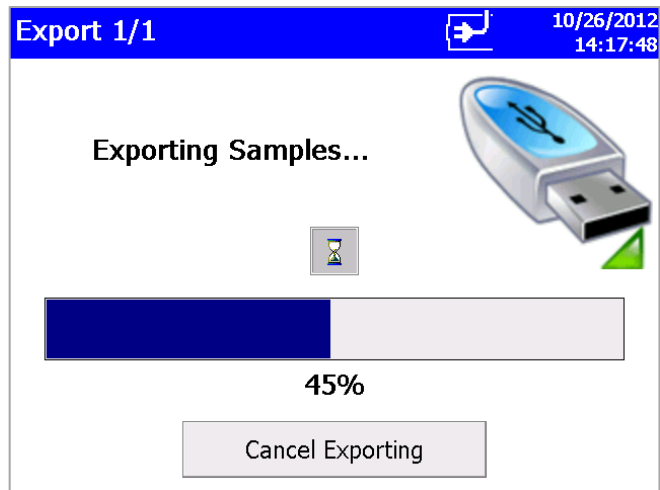

Caution

Do **NOT** remove the external drive during the export process. If the thumbdrive is removed, re-insert and restart the download process. Data stored on the instrument is not lost during the transfer.

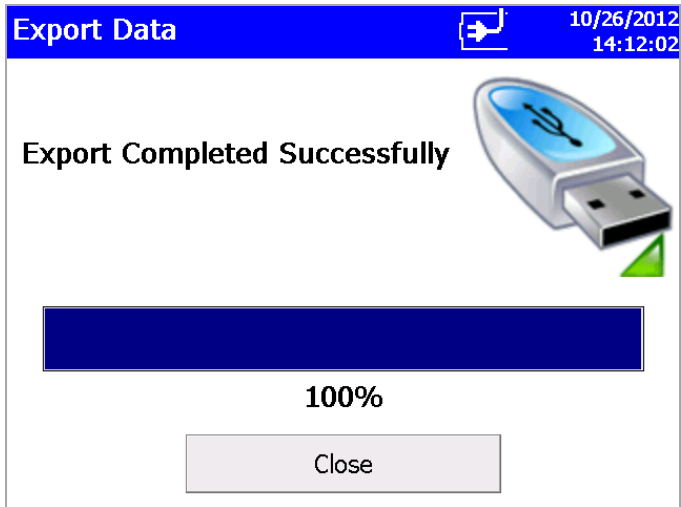

Print Data

The print button allows a range of sample data to be printed using the optional printer. You can also select to print a summary along with the full report.

To Print Data

1. Click the **Printer** icon on the Data tab. The following screen appears.

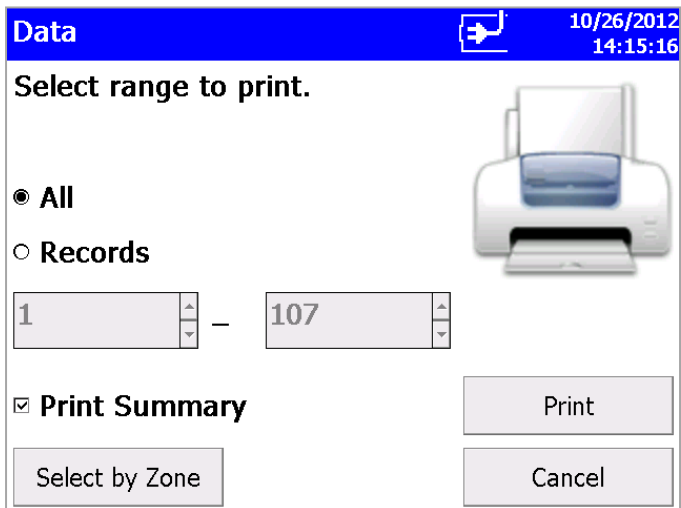

2. Use the screen above to enter the records you want to print, or press **Select by Zone** and enter the Zone data to print (see the following screen).

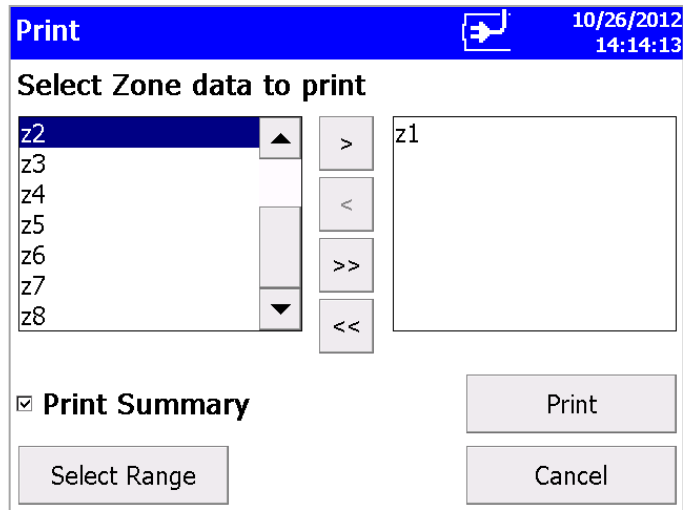

3. Once you have identified the records or Zones to print, press the **Print...** button. Check **Print Summary** to print a summary of the data after all records are printed.
4. The print data screen shows progress on the current selected range of sample data to be printed. Press the **Cancel** button to cancel the rest of the print job.

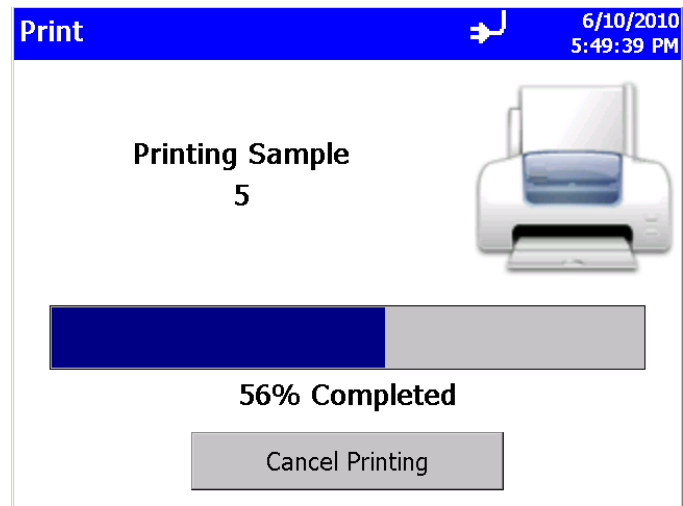

Reports Tab

Use the Reports Tab screen to select various standard reports for viewing and printing.

Field	Description
Zone	Select the zone from the dropdown list.
Standard	Select the standard from the dropdown list.
Class	Select the class from the dropdown list.
Sample to Exclude	Select the sample to exclude from the dropdown list.
Generate	Press to begin generating a report that you can view on-screen or print.

(This page intentionally left blank)

CHAPTER 4

Data Handling

USB Data Download

The Model 9306 AeroTrak® Handheld Airborne Particle Counter is equipped with a USB A host drive that will allow for the downloading of stored data to a USB Thumb drive. To download data, attach a thumb drive to the USB A host port and follow the instructions in the [operation section](#) of this manual. The data is downloaded in XML format that can be opened in Microsoft Excel® version 2003 or greater. The data files can also be opened in the latest versions of OpenOffice™ application.



USB Computer Communication

The Model 9306 AeroTrak[®] Handheld Airborne Particle Counter is equipped with a USB compatible cable for uploading and downloading information to a PC. The cable plugs into the right side of the instrument.



Installing Software

See the *TrakPro™ Lite Secure Software (version 3.0 or later) User's Guide (P/N 6004404)* on CD (P/N 7001901) for installation instructions.

Ethernet Communications

An Ethernet port is provided for use with TSI Facility Monitoring Software (FMS). Refer to the FMS Software documentation and the TSI service and installation manual for detailed configuration and operation information on Modbus[®] TCP over Ethernet.



CHAPTER 5

Maintenance

Note

There are no user-serviceable parts inside this instrument. Opening the instrument case may void the warranty. TSI recommends that you return the AeroTrak® Airborne Particle Counter to the factory for any required maintenance or service not described in this manual.

Maintenance Schedule

TSI recommends annual factory cleaning and calibration for the AeroTrak® Airborne Particle Counter. See [Chapter 7, "Contacting Customer Service"](#) for service/calibration.

Recommended Field Maintenance Schedule

Item	Frequency
Zero check	Daily or according to application.
Factory cleaning and calibration	Annually.
Cleaning the instrument enclosure	As needed.

Zero Check

The zero check ensures that the instrument is properly assembled and free from leaks, residual particles and electronic noise.

Cleaning the Instrument Enclosure

To clean the enclosure, dampen a lint-free cloth and gently wipe the surface until surface contamination is removed.

(This page intentionally left blank)



CHAPTER 6

Troubleshooting

Symptom	Possible Cause	Corrective Action
Counts are too low.	<p>Instrument is being operated outside temperature or relative humidity specifications.</p> <p>Internal parts have been damaged because instrument was stored at a temperature greater than 122°F (50°C).</p> <p>Instrument has contamination on the optics due to condensation or excessive loading.</p> <p>Laser or pump control is damaged.</p> <p>Unit is due for calibration.</p>	<p>Operate instrument within specifications.</p> <p>Return to factory or factory authorized service centers for service.</p> <p>Return to factory or factory authorized service centers for service.</p> <p>Return to factory or factory authorized service centers for service.</p> <p>Return to factory or factory authorized service centers for service.</p>
Instrument does not turn on.	<p>Battery is not charged.</p> <p>AC cord is not plugged into unit.</p>	<p>Recharge battery or connect to AC power.</p> <p>Connect AC cord.</p>

continued on next page

Symptom	Possible Cause	Corrective Action
Instrument does not meet zero count specification (<1 particle/5 mins).	<p>Particles are in the instrument chamber.</p> <p>HEPA filter is not connected properly and room air is leaking into the HEPA filter assembly.</p> <p>Residual particles from previous samples are shedding off internal parts and into the optics.</p> <p>An internal component has been damaged due to operation outside of temperature specifications or one or more excessive bumps or jolts, and electronic noise is inducing false counts.</p> <p>A leak has developed in the aerosol flow path.</p> <p>Internal optics have become dirty.</p>	<p>Run the instrument for one-half hour with a filter and then recheck the zero count.</p> <p>Check that the HEPA filter has been tightly connected to the inlet. Check that rubber O-ring (black) on the inlet is in place.</p> <p>Purge instrument by running the instrument for 10 to 15 minutes before attempting zero count test. If instrument has heavier contamination, purge of 1 hour or longer may be needed.</p> <p>Return to factory or factory authorized service centers for service.</p> <p>Return to factory or factory authorized service centers for service.</p> <p>Return to factory or factory authorized service centers for service.</p>
Battery does not charge.	<p>The unit must be turned on but not in sampling mode for the battery to charge.</p> <p>Unit not put in standby mode.</p>	<p>Turn on unit.</p> <p>The battery will only charge if the unit is turned on but is not actively taking a sample.</p> <p>Select Standby/Charge when shutting off the instrument if you want the battery to be charged.</p>
<p>LOW BATTERY ERROR</p> 	Low battery.	Recharge battery or connect AC cord.
SYSTEM ERROR	Information is not being read properly by microprocessor.	Restart instrument. If problem persists, contact TSI technical support.

Symptom	Possible Cause	Corrective Action
TEMPERATURE HUMIDITY PROBE ERROR	Temperature/RH probe was not recognized.	Detach and reconnect probe. If problem persists, contact TSI technical support.
FLOW ERROR 	Instrument was unable to control flow rate (if any tubing is connected to particle counter). Pressure drop across inlet may be too large. Inlet not at ambient pressure.	Restart measurement. Lessen pressure drop across inlet by using larger diameter tubing, less tubing, and/or adding a bleed valve. Do not subject the unit to other than ambient pressure conditions.
LASER POWER / DETECTOR WARNING 	Excessive direct light is entering the aerosol inlet. Optical path blocked. Nozzle is misaligned. Fiber attached on the nozzle tip. Detector board damaged. Laser power is normal.	Remove instrument from direct light. Return to factory for service. Contact TSI and return to factory. Return to factory or factory authorized service centers for service.

(This page intentionally left blank)

CHAPTER 7

Contacting Customer Service

This chapter gives directions for contacting people at TSI Incorporated for technical information and directions for returning the Model 9306 AeroTrak® Handheld Particle Counter for service.

Technical Contacts

- If you have any difficulty setting up or operating the AeroTrak® Model 9306, or if you have technical or application questions about this system, contact an applications engineer at TSI Incorporated, 1-800-874-2811 (USA) or (651) 490-2811 or e-mail technical.service@tsi.com.
- If the AeroTrak® Model 9306, does not operate properly, or if you are returning the instrument for service, visit our website at <http://rma.tsi.com>, or contact TSI Customer Service at 1-800-874-2811 (USA) or (651) 490-2811.

International Contacts

Service

TSI Instruments Singapore Pte Ltd
150 Kampong Ampat
#05-05 KA Centre
Singapore 368324

Telephone: +65 6595-6388
Fax: +65 6595-6399
E-mail: tsi-singapore@tsi.com

TSI Instrument (Beijing) Co., Ltd.
Room 3A04, Yingu Tower,
No.9, North 4th Ring West Road,
Haidian District, Beijing, 100190
CHINA

Telephone: +86-10-8251 6588
Fax: +86-10-8251 6599
E-mail: tsibeijing@tsi.com

TSI Instruments Ltd.

Stirling Road
Cressex Business Park
High Wycombe, Bucks
HP12 3ST
UNITED KINGDOM

Telephone: +44 (0) 149 4 459200
Fax: +44 (0) 149 4 459700
E-mail: tsiuk@tsi.com

Technical Support**TSI Instruments Singapore Pte Ltd**

150 Kampong Ampat
#05-05 KA Centre
Singapore 368324

Telephone: +65 6595-6388
Fax: +65 6595-6399
E-mail: tsi-singapore@tsi.com

TSI Instrument (Beijing) Co., Ltd.

Room 3A04, Yingu Tower,
No.9, North 4th Ring West Road,
Haidian District, Beijing, 100190
CHINA

Telephone: +86-10-8251 6588
Fax: +86-10-8251 6599
E-mail: tsibeijing@tsi.com

TSI GmbH

Neuköllner Strasse 4
52068 Aachen
GERMANY

Telephone: +49 241-52303-0
Fax: +49 241-52303-49
E-mail: tsigmbh@tsi.com

TSI Instruments Ltd.

Stirling Road
Cressex Business Park
High Wycombe, Bucks
HP12 3ST
UNITED KINGDOM

Telephone: +44 (0) 149 4 459200
Fax: +44 (0) 149 4 459700
E-mail: tsiuk@tsi.com

TSI France Inc.
Hotel technologique
BP 100
Technopôle de Château-Gombert
13382 Marseille cedex 13
FRANCE

Telephone: + 33 (0) 491 11 87 64

Fax: + 33 (0) 491 11 87 65

E-mail: tsifrance@tsi.com

Returning the AeroTrak[®] Handheld Airborne Particle Counter for Service

Visit our website at <http://rma.tsi.com> or call TSI at 1-800-874-2811 (USA) or (651) 490-2811 for specific return instructions. Customer Service will need this information when you call:

- The instrument model number
- The instrument serial number
- A purchase order number (unless under warranty)
- A billing address
- A shipping address

Use the original packing material to return the instrument to TSI. If you no longer have the original packing material, seal off any ports to prevent debris from entering the instrument and ensure that the display and the connectors on the instrument front and back panels are protected.

(This page intentionally left blank)

APPENDIX A

Specifications

All specifications meet or exceed ISO 21501-4 and JIS B9921. They are subject to change without notice.

Size Range	0.3 to 25 µm
Channel Sizes	Standard: 0.3, 0.5, 0.7, 1.0, 2.0, 5.0 µm Standard: 0.3, 0.5, 1.0, 3.0, 5.0, 10.0 µm Standard: 0.3 to 10 µm, user-selectable; factory-calibrated at 0.3, 0.5, 1.0, 3.0, 5.0, 10.0 µm. Additional channel sizes available
Size Resolution	<15% at 0.5 µm (per ISO 21501-4 requirements)
Counting Efficiency	50% at 0.3 µm; 100% for particles > 0.45 µm (per JIS and ISO 21501-4)
Concentration Limits	3,000,000 particles/ft ³ at 5% coincidence loss
Light Source	Long life laser diode
Zero Count Level	<1 count/5 minutes (per JIS B9921 and ISO 21501-4)
Flow Rate	0.1 CFM (2.83 L/min) with ±5% accuracy (meets JIS and ISO 21501-4 requirements)
Calibration	NIST traceable with TSI calibration system
Calibration Frequency	Recommended minimum once per year
Sample Probe/Tubing	Isokinetic sampling probe
Sampling Modes	Manual, automatic, beep, cumulative/differential count or concentration
Sampling Time	1 second to 99 hours
Sampling Frequency	1 to 9999 cycles or continuous
Exhaust	Internally filtered
Vacuum Source	Internal pump
Communication Mode	Modbus [®] TCP over Ethernet or USB
Data Storage	10,000 sample records: includes date, time, six particle channels, flow, ID, and sample volume; transferable via USB data download or TrakPro [™] Lite software
Data Security	Password protected
Alarm/Status	Audible alarm on counts, low battery, and sensor status indicators
Environmental Sensors	Optional temperature/RH probe supported
Display	QVGA 3.5-inch (8.9-cm) touch screen with Windows [®] CE operating system

Languages	English, Spanish, German, French, Italian, Japanese, and Chinese (simplified)
Reports	Provides Pass/Fail on FS-209E, ISO 14644-1 and EU GMP
Printer	Optional external printer supported
External Surface	High impact injection molded plastic
AC Power (power to AC adapter)	110 to 240 VAC 50 to 60 Hz Universal in-line power supply
DC Power (power to instrument)	12 VDC @ 2.5 A
Battery	Removable/rechargeable Li-Ion
Battery Life	>Up to 7 hours of continuous use
Recharge Time	4 hours
Dimensions (L x W x H)	9.4 x 4.9 x 3.2 in.(23.9 x 12.4 x 8.1 cm)
Weight	1.0 kg (2.2 lbs) with battery
Standards	CE, JIS B9921, ISO 21501-4 as listed above
Warranty	2 years. Extended warranties available
Operating Conditions	41 to 95°F (5°C to 35°C); 20% to 95% non-condensing relative humidity
Storage Conditions	32 to 122°F (0°C to 50°C); Up to 98% non-condensing relative humidity
Included Accessories	Power supply, power cord, battery, isokinetic inlet, stylus, purge filter, TrakPro™ Lite data download software, operational manual on CD, computer cable, calibration certificate, and Quick Start Guide.
Optional Accessories	Temp R/H probe, stainless steel isokinetic inlet and probe, tubing, barbed inlet fitting, printer, printer paper, carrying case and external battery charger

Temperature/RH Probe (700084) Specifications (optional accessory)

Temperature	
Range	32 to 115°F (0 to 45°C)
Accuracy	±4°F (±2°C)
Relative Humidity	
Range	10 to 90% RH
Accuracy	±5% RH

Compliance

CE Marking	EN61326 / EN 55011, Class BA: Radiated Emissions EN61326 / EN 55011, Class BA: Conducted Emissions EN61000-3-2: Harmonics EN61000-3-3: Voltage Fluctuations EN61000-4-2: Electrostatic Discharge Immunity EN61000-4-3: Electromagnetic Field Immunity EN61000-4-4: Burst Immunity EN61000-4-6: Conducted PS Immunity EN61000-4-5: Surge Immunity EN61000-4-8: Rated Power-Frequency Field Immunity EN61000-4-11: Voltage Dips\Short Interruptions Immunity
RoHS Marking	Yes

Dimensional Diagram

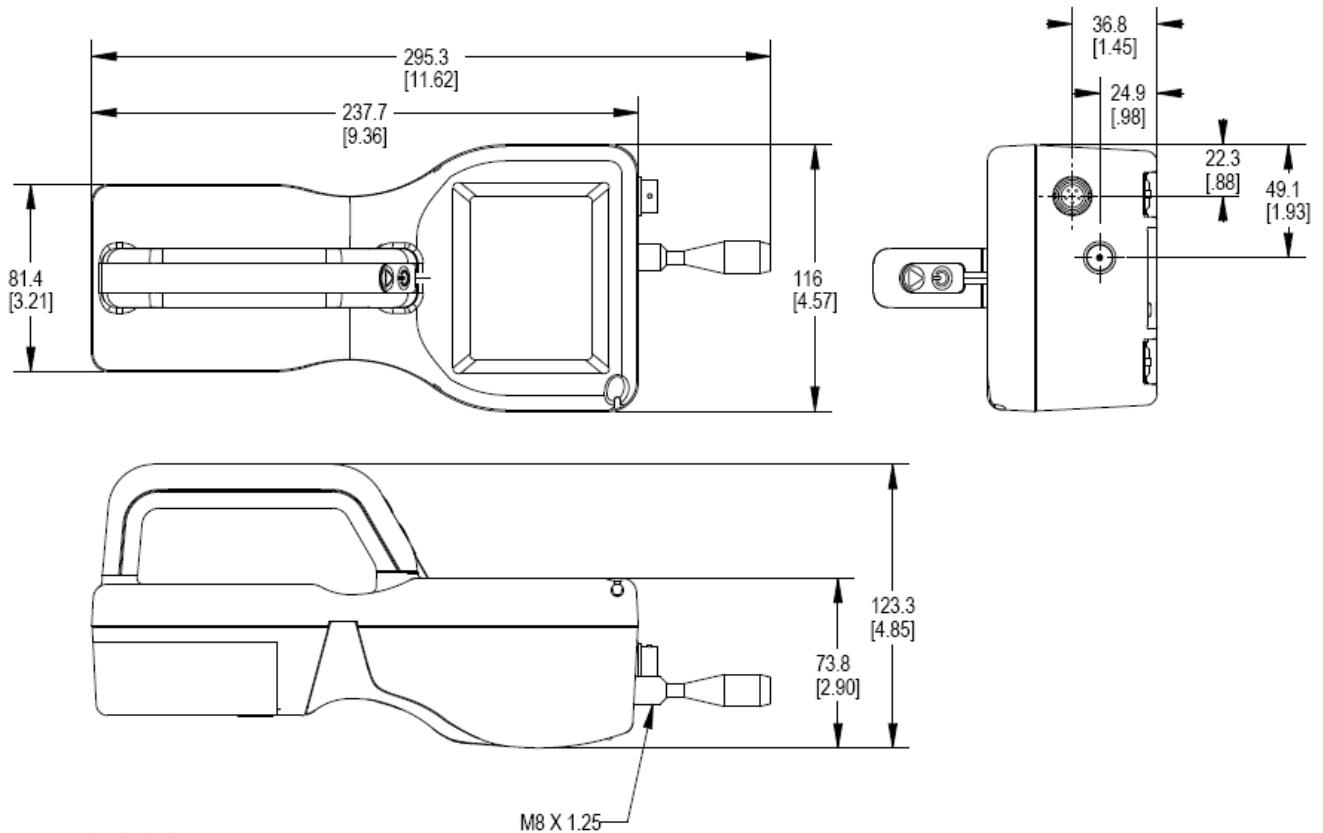

(This page intentionally left blank)

Index

2

24 hour, 3-22

A

AC power, A-2
accessories, A-2
 optional, 1-3, A-2
add zone, 3-8
air flow, 3-7, 3-33
alarm, 3-28
alarm volume level, 3-18
alarm/status, A-1
area, 3-7
automatic, 3-12
automatic printing, 3-20

B

barb inlet fitting, 1-4
battery, A-2
 external charger, 1-3
 installation, 2-3
 life, A-2
 low battery error, 6-2
 not charging, 6-2
 pack, 1-2
 recharge time, A-2
battery low, 3-3
beep, 3-12
bin size, 3-5
both, 3-29

C

calibration, A-1
 maintenance, 5-1
calibration certificate, 1-3
Calibration label, viii
cancel printing button, 3-32
carry case, 1-3
caution
 description, ix
 symbol, ix
CE marking, A-3
change setup, 3-17
change setup password
 confirm new password, 3-17
 new password, 3-17
 old password, 3-17
channel size, 3-27
channel sizes, A-1
class, 3-7
class level, 3-33

clear samples screen, 3-21
communication mode, A-1
communications
 default gateway, 3-24
 IP address, 3-24
 subnet mask, 3-24
 use dhcp, 3-24
communications screen, 3-24
compliance, A-3
computer cable, 1-2
concentration limits, A-1
configuration screen, 3-18
 particle density, 3-18
 store partial samples, 3-18
 volume, 3-18
 zoom, 3-18
confirm new password, 3-16, 3-17
contacting TSI, 7-1
 email address, iii
counting efficiency, A-1
counts too low, 6-1
cumulative, 3-19
cumulative mode, 3-27
customer service, 7-1

D

data handling, 4-2
data security, A-1
data storage, A-1
data tab, 3-27
 alarm, 3-28
 cumulative mode, 3-27
 date, 3-28
 differential mode, 3-27
 export data, 3-27
 flow, 3-28
 humidity, 3-28
 laser, 3-28
 location, 3-27
 print data, 3-27
 record, 3-28
 records, 3-28
 sample, 3-27
 size, 3-27
 temperature, 3-28
 time, 3-28
 vol, 3-28
 zone, 3-27
date, 3-22, 3-28
date and time
 24 hour, 3-22
 date, 3-22
 time, 3-22

date and time screen, 3-22
DC power, A-2
default gateway, 3-24
delay, 3-4, 3-13
delete zone, 3-8
detector warning, 6-3
device setup, 3-6
device setup screen, 3-21
differential, 3-19
differential mode, 3-27
dimensions, A-2, A-3
display, A-1
 screen alignment, 3-23
display screen, 3-23

E

edit zone, 3-9
edit zone screen, 3-9
environment screen, 3-26
environment setup, 3-6
environmental sensors, A-1
ESD protection, ix
Ethernet, 4-2
European symbol for non-
 disposable item, viii
export data, 3-27, 3-28
export data screen, 3-28, 3-29
 both, 3-29
 completed successfully, 3-31
 secured file, 3-29
 unsecured file, 3-29
external printer, 1-3
external surface, A-2

F

flow, 3-28
 error, 6-3
flow rate, A-1
formats, 3-25
functionality, 3-1

G

generate, 3-33
getting help, x
getting started, 2-1

H

help, x, 7-1
HEPA zero filter assembly, 1-2
hold, 3-13
humidity, 3-28

I

- isokinetic inlet, 2-1
- information screen, 3-23
- instrument description, 2-1
- instrument enclosure
 - cleaning, 5-1
 - maintenance, 5-1
- instrument not meeting zero count specification, 6-2
- instrument not turning on, 6-1
- introduction, 1-1
- IP address, 3-24
- ISO 21501-4, A-2
- isokinetic inlet, 1-2
 - installation, 2-5
- isokinetic probe, 1-4

J

- JIS B9921, A-2

K

- keyboard, 3-2

L

- language, 3-25
- languages, A-2
- largest particle size to consider, 3-7
- laser, 3-28
- laser power warning, 6-3
- laser radiation label, viii
- laser radiation symbol label, viii
- laser safety, vii
- last calibration, 3-19
- light source, A-1
- location, 3-4, 3-5, 3-27
- location icon, 3-3
- locations, 3-7
- locations screen, 3-8, 3-10
- locations tab, 3-8

M

- main tab, 3-2
- maintenance
 - schedule, 5-1
- manual, 3-12
- manual history, ii
- manual/automatic/beep, 3-4
- model name, 3-19

N

- name, 3-7
- new password, 3-16, 3-17

O

- old password, 3-16, 3-17
- on alarm, 3-20
- on sample, 3-20

- operating conditions, A-2
- operation, 3-1

P–Q

- packing instructions, 7-3
- particle count/concentration, 3-5
- particle density, 3-18
- password
 - changing, 3-17
- power, A-2
 - providing, 2-3
 - using, 2-4
- power button, 2-1
- power entry button, 2-1
- power on password
 - confirm new password, 3-16
 - new password, 3-16
 - old password, 3-16
- power on password screen, 3-15
- power supply, 1-2
- print
 - icon, 3-4
 - schedule screen, 3-20
 - settings screen, 3-19
- print data, 3-27, 3-31
 - button, 3-31
- print data screen, 3-31, 3-32
 - select by zone, 3-32
- print schedule
 - automatic printing, 3-20
 - on alarm, 3-20
 - on sample, 3-20
- print screen
 - differential, 3-19
- print setup screen
 - cumulative, 3-19
 - last calibration, 3-19
 - model name, 3-19
 - separator, 3-19
 - serial number, 3-19
- printer, A-2
 - using, 2-4
- printer paper
 - colored strip, 3-19
- printer port, 2-1

R

- recipe, 3-7
- recipe screen, 3-10
- recipes, 3-6
- recipes screen
 - channels T tab, 3-14
 - recipe tab, 3-11
 - timing tab, 3-13
 - cycles, 3-13
 - delay, 3-13
 - hold, 3-13
 - sample time, 3-13
 - volume, 3-13
- recipes setup screen, 3-11
 - automatic, 3-12

- recipes setup screen (*cont.*)

- beep, 3-12
 - manual, 3-12
- records, 3-28
- recs, 3-4
- regional
 - formats, 3-25
 - language, 3-25
- regional screen, 3-25
- relative humidity, 3-5
 - probe, A-2
- reports, A-2
- reports tab, 3-33
 - air flow, 3-33
 - class level, 3-33
 - generate, 3-33
 - room area, 3-33
 - room status, 3-33
- returning for service, 7-3
- RoHS marking, A-3
- room area, 3-33
- room status, 3-33

S

- safety, vii
- sample, 3-13, 3-27
- sample output, A-1
- sample probe/tubing, A-1
- sample time, 3-13
- sampling
 - frequency, A-1
 - modes, A-1
 - time, A-1
- save, 3-9
- save new zone, 3-9
- screen alignment, 3-23
- screen layout, 3-1
- secured file, 3-29
- separator, 3-19
- serial number, 3-19
- serial number label, viii
- service
 - returning, 7-3
- setup tab, 3-6
 - device setup, 3-6
 - environment setup, 3-6
 - recipes, 3-6
 - system setup, 3-6
 - zones setup, 3-6
- size, 3-27
- size range, 1-1, A-1
- software
 - installation, 4-2
- specifications, A-1
- stainless steel isokinetic inlet, 1-4
- stand, 2-1
 - using, 2-2
- standard, 3-7
- standards, A-2
- start sample, 2-1
- start/stop buttons, 3-4, 3-5
- status, 3-7

- storage conditions, A-2
- store partial samples, 3-18
- stylus, 1-2, 2-1
 - using, 2-2
- subnet mask, 3-24
- superthane tubing, 1-4
- system error, 6-2
- system setup, 3-6
- system setup screen, 3-15

- zone setup screen, 3-7
- zones setup, 3-6
- zoom, 3-18
- zoomed data screen, 3-5

T

- TCP/IP, 3-24
- technical contacts, 7-1
- temperature, 3-5, 3-28
 - probe, A-2
- temperature/humidity probe, 1-4
 - error, 6-3
 - installation, 2-6
- time, 3-4, 3-22, 3-28
- touch screen, 2-1
- troubleshooting, 6-1

U

- unpacking, 1-2
- unsecured file, 3-29
- USB computer communication, 4-2
- USB port, 2-1
- use dhcp, 3-24

V

- vacuum source, A-1
- vol, 3-28
- volume, 3-13

W-X-Y

- warning
 - description, ix, 2-3
 - symbol, ix
- warranty, iii, A-2
- weight, A-2

Z

- zero check, 5-1
 - maintenance, 5-1
- zero count level, A-1
- zone, 3-4, 3-27
- zone icon, 3-3
- zone report screen, 3-33
- zone setup
 - add zone, 3-8
 - air flow, 3-7
 - area, 3-7
 - class, 3-7
 - delete zone, 3-8
 - edit zone, 3-9
 - locations, 3-7
 - name, 3-7
 - recipe, 3-7
 - standard, 3-7
 - status, 3-7



UNDERSTANDING, ACCELERATED

TSI Incorporated – Visit our website www.tsi.com for more information.

USA	Tel: +1 800 874 2811	India	Tel: +91 80 67877200
UK	Tel: +44 149 4 459200	China	Tel: +86 10 8251 6588
France	Tel: +33 4 91 11 87 64	Singapore	Tel: +65 6595 6388
Germany	Tel: +49 241 523030		