

CD Soundmachine

Register your product and get support at
www.philips.com/welcome

AZ102S
AZ102C
AZ102N
AZ102G
AZ102V
AZ102R
AZ102B

User Manual



1

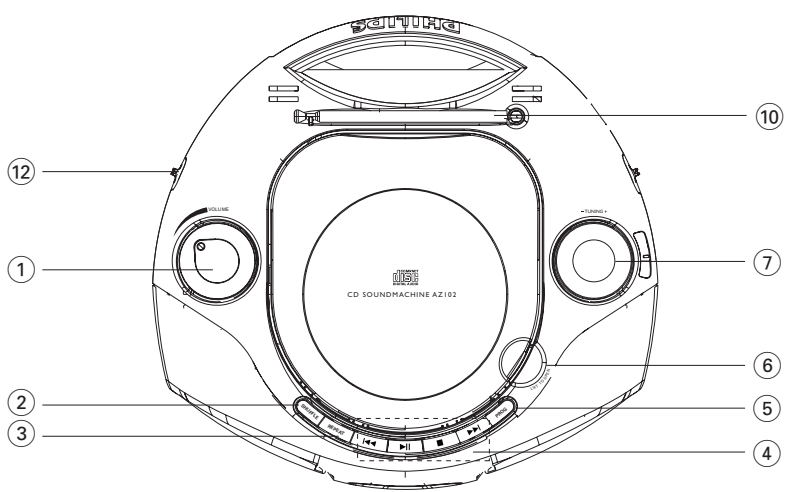
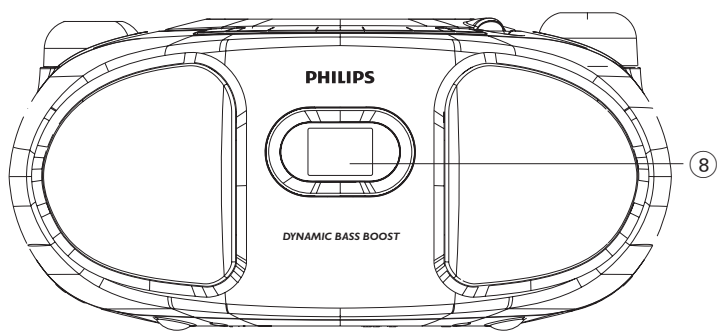

2

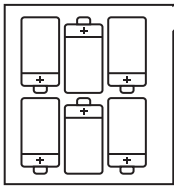
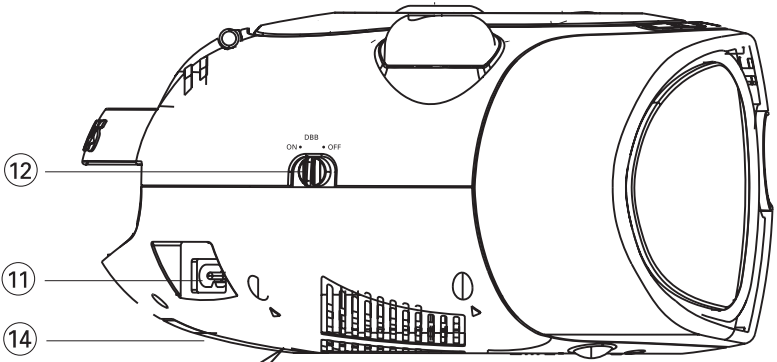

6 x R14 • UM-2 • C-CELLS

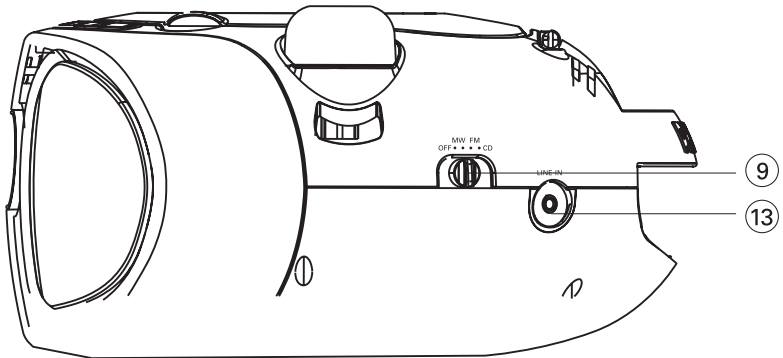

3



7



4

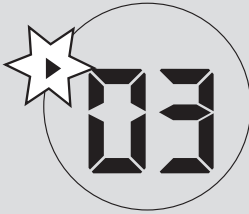

8



5



6

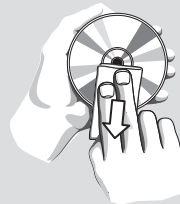
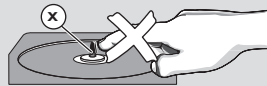

Congratulations on your purchase and welcome to Philips!

To fully benefit from the support that Philips offers, register your product at www.philips.com/welcome.

Supplied Accessories

- AC power cord

Top/front panels (See 1)

- ① **VOLUME** – adjusts volume level.
- ② **SHUFFLE** – plays all tracks in random order
- ③ **REPEAT** – repeats a track/
CD program/entire CD.
- ④ **▶ II** – starts or pause CD playback
▶▶|◀◀ – selects the next/previous track
– searches forwards/backwards (press and hold the button) within the current track
■ – stops CD playback;
– erases a CD program
- ⑤ **PROG** – programs tracks and reviews the program
- ⑥ **LIFT TO OPEN**
– opens/closes the CD door.
- ⑦ **TUNING** – tunes to radio stations
- ⑧ **Display** – shows the CD functions

Back panel (See 1 and 2)

- ⑨ **Source selector: CD, FM, MW, OFF**
– selects CD or radio source of sound
– power off switch
- ⑩ **Telescopic antenna**
– improves FM reception.
- ⑪ **AC MAINS~** – inlet for power cord.
- ⑫ **DBB** – turns the bass enhancement on/off.
- ⑬ **LINE-IN** – inlet for external audio source.

Bottom panel

- ⑭ **Battery door** – Press on the arrow and push to insert 6 x 1.5V **R-14/ UM-2/ C-cells**.

CAUTION

- *Visible and invisible laser radiation. If the cover is open, do not look at the beam.*
- *High voltage! Do not open. You run the risk of getting an electric shock. The machine does not contain any user-serviceable parts.*
- *Modification of the product could result in hazardous radiation of EMC or other unsafe operation.*
- *Use of controls or adjustments or performance of procedures other than herein may result in unsafe operation.*

This set complies with the radio interference requirements of the European Union.

Power Supply

Whenever convenient, use the power supply cord if you want to conserve battery life. Make sure you remove the plug from the set and wall outlet before inserting batteries.

Batteries (not included)

- 1 Open the battery door and insert 6 batteries, type **R-14, UM-2** or **C-cells**, (preferably alkaline) with the correct polarity as indicated by the "+" and "-" symbols inside the compartment.
- 2 Replace the battery door, making sure the batteries are firmly and correctly in place. The set is now ready to operate.

Batteries contain chemical substances, so they should be disposed of properly.

- *Incorrect use of batteries can cause electrolyte leakage and will corrode the compartment or cause the batteries to burst:*
- *Do not mix battery types: e.g. alkaline with carbon zinc. Only use batteries of the same type for the set.*
- *When inserting new batteries, do not try to mix old batteries with the new ones.*
- *Remove the batteries if the set is not to be used for a long time.*

Using AC power

WARNING: Always check you have completely switched off the set, before you change or disconnect power supply.

- 1 Check if the power voltage, as shown on the **type plate located on the bottom of the set**, corresponds to your local power supply. If it does not, consult your dealer or service center.
 - 2 Connect the power cord to the **AC MAINS~** inlet and the wall socket. The set is now connected and ready for use.
 - 3 To switch the set off completely, withdraw the power cord from the wall socket.
 - 4 Install the unit near the AC outlet and where the AC power plug can be easily reached.
- Disconnect the power cord from the wall socket to protect your set during heavy thunderstorms. Children could seriously injure themselves as the free end of the cable may still be live if only the connector is removed from the MAINS socket at the back of the unit.

The type plate is located on the bottom of the set.

Helpful hints:

- To avoid unnecessary energy consumption, always adjust the **Source selector** to **OFF** after using the set.

General operation

Switching on and off and selecting the function

- 1 To select your sound source, adjust the **Source selector** to: **CD**, **FM** or **MW**.
- 2 To switch off the set, adjust the **Source selector** to **OFF** position.
- 3 To switch to **LINE IN** mode, connect an external audio source to the **LINE-IN** inlet.

Helpful hints:

- The set switches to **LINE IN** mode automatically when an external audio source is connected, no matter the set is in **CD**, **FM** or **MW** mode.
- The **LINE-IN** inlet is not for earphones.

Adjusting volume and sound

Adjust the sound with the **VOLUME** and **DBB** controls.

Radio reception

- 1 Adjust the **Source selector** to **FM** or **MW**.
- 2 Turn **TUNING** to tune to a station.

Helpful hints:

To improve radio reception

- For **FM**, extend, incline and turn the telescopic antenna for best reception. Reduce its length if the signal is too strong.
- For **MW**, the set uses a built-in antenna. Direct this antenna for best reception by turning the whole set.

CD Player

Playing a CD

- This CD player plays Audio Discs including CD-Recordables (CD-R) and CD-Rewritables (CD-RW).
- MP3, CD-ROM, CD-I, CDV, VCD, DVD or computer CDs are not possible for playback.

IMPORTANT!

CDs encoded with **copyright protection technologies** by some record companies may be unplayable by this product.

- 1 Adjust the **Source selector** to **CD**.
- 2 Open the CD door, and insert a CD with the printed side facing up, then press the CD door gently to close.
→ Display shows --, and later the total number of tracks. (See [3])
- 3 Press ►|| to start playback.
- 4 To pause playback, press ►||.
→ Display: ► flashes. (See [4])
- 5 To resume, press ►|| again.
- 6 To stop CD playback, press ■.

Helpful hints:

CD play will also stop when:

- you open the CD door;
- you select **FM**, **MW** or **OFF** sound source;
- the CD has reached the end.

Selecting a different track

- Press ◀◀ / ▶▶ once or repeatedly until the desired track number appears in the display.
- In the pause/stop position, press ►|| to start playback.

Finding a passage within a track

- 1 During playback, press and hold ◀◀ or ▶▶.
→ The CD is played at high speed and with reduced volume.
- 2 When you recognize the passage you want, release ◀◀ or ▶▶ to resume normal playback.



Helpful hints:

- When your searching reaches the end of the last track, the CD goes to stop mode.

CD Player

Programming track numbers

You may store up to 20 tracks in the desired sequence. If you like, store any track more than once.

- 1 In the stop position, press **PROG** to activate programming.
→ Display: **PROG** and  flash. (See [5](#))
- 2 Press **◀** or **▶** to select your desired track number.
- 3 Press **PROG** to store the desired track number.
→ Display: **PROG** and  flash for you to program the next track..
- 4 Repeat steps 2 to 3 to select and store all desired tracks in this way.
→ If you attempt to store more than 20 tracks, no track can be selected and the display shows --.
- 5 To play your program, press **▶/II**.

Helpful hints :

- When playback of your program comes to the stop position, your set will return to normal playback. To re-enter program mode, press **PROG** in the stop position.

Reviewing the program

In the stop position, press **PROG** repeatedly to see your stored tracks.

Erasing a program

You can erase the contents of the memory by:

- in the stop position, press **PROG** to enter program mode, and then press **■**.
- selecting **FM**, **MW** or **OFF**;
- opening the CD door;

Different play modes: REPEAT. and SHUFFLE (See [6](#), [7](#))

REPEAT

You can play the current track or the whole disc repeatedly, and combine **REPEAT** modes with **PROG** (PROGRAM).

REP – plays the current track continuously.

REP ALL – repeats the entire CD/program

- 1 To select play mode, press **REPEAT** once or more.
→ The display shows **REP** icon or **REP ALL** icon.
- 2 Press **▶/II** to start playback if in the stop/pause position.
- 3 To return to normal playback, press **REPEAT** repeatedly until the modes are no longer displayed.
– You can also press **■** to cancel your play mode.

SHUFFLE

You can play all the tracks in random order.

- 1 In the stop position, press **SHUFFLE** to switch on shuffle play.
→ Display shows **SHUFFLE** icon.
- 2 To switch off shuffle play, press **■**.

Helpful hints:

- During the shuffle play, when **REP** function is selected, it will play the current shuffled track repeatedly, or when the **REP ALL** function is selected, it will repeat the shuffle play of the entire CD.

CD player and CD handling

- If the CD player cannot read CDs correctly, use a cleaning CD to clean the lens before taking the set to repair.
- The lens of the CD player should never be touched!
- Sudden changes in the surrounding temperature can cause condensation on the lens of your CD player. Playing a CD is then not possible. Do not attempt to clean the lens but leave the set in a warm environment until the moisture evaporates.
- Always close the CD door to avoid dust on the lens.
- To clean the CD, wipe in a straight line from the center towards the edge using a soft, lint-free cloth. Do not use cleaning agents as they may damage the disc.
- Never write on a CD or attach any stickers to it.

Safety information

- Place the set on a flat, hard and stable surface so that the system does not tilt.
- Where the MAINS plug or an appliance coupler is used as the disconnect device, the disconnect device shall remain readily operable.
- Do not expose the set, batteries, CDs to humidity, rain, sand or excessive heat caused by heating equipment or direct sunlight.
- The apparatus shall not be exposed to dripping or splashing.
- Adequate ventilation with a minimum gap of 15cm (6 inches) between the ventilation holes and surrounding surfaces is necessary to prevent heat build-up.
- Do not cover the ventilation openings with items such as newspapers, table-cloths, curtains, etc.
- No objects filled with liquids, such as vases, shall be placed on the apparatus.
- No naked flame sources, such as lighted candles, should be placed on the apparatus.
- The mechanical parts of the set contain self-lubricating bearings and must not be oiled or lubricated.
- To clean the set, use a dry cloth. Do not use any cleaning agents containing alcohol, ammonia, benzene or abrasives as these may harm the housing.

Troubleshooting

If a fault occurs, first check the points listed below before taking the set for repair.
If you are unable to remedy a problem by following these hints, consult your dealer or service centre.

WARNING: *Do not open the set as there is a risk of electric shock. Under no circumstances should you try to repair the set yourself, as this will invalidate the guarantee.*

Problem

- Possible cause
- Remedy

No sound /power

- Volume not adjusted
- Adjust the VOLUME
- Power cord not securely connected
- Connect the AC power cord properly
- Batteries dead/ incorrectly inserted
- Insert (fresh) batteries correctly
- CD contains non-audio files
- Press ◀◀ , ▶▶ once or more to skip to a CD audio track, instead of the data file.

Display does not function properly / No reaction to operation of any of the controls

- Electrostatic discharge
- Switch off and unplug the set. Reconnect after a few seconds

--, Er or 0 ! indication

- No CD inserted
- Insert a CD
- CD badly scratched or dirty
- Replace/ clean CD, see Maintenance
- Laser lens steamed up
- Wait until lens has cleared
- CD-R/CD-RW is blank or not finalized
- Use a finalized CD-R/CD-RW or suitable CD Audio disc only

Note:

Make sure the CD is not encoded with copyright protection technologies, as some do not conform to the Compact Disc standard.

The CD skips tracks

- CD damaged or dirty
- Replace or clean CD
- Program/shuffle is active
- Quit program/shuffle mode

Note: A CD badly scratch or dirty may result in improper operation.

Environmental information

All unnecessary packaging material has been omitted. The packaging can be easily separated into three materials: cardboard, polystyrene and plastic.

Your set consists of materials which can be recycled if disassembled by a specialized company. Please observe the local regulations regarding the disposal of packaging, dead batteries and old equipment.

Specifications

Power consumption	≤ 15 W
Dimensions.....	290 mm x 143 mm x 240 mm
Weight.....	1.62 kg

Meet Philips at the Internet
<http://www.philips.com>



**CLASS 1
LASER PRODUCT**

AZ102S
AZ102C
AZ102N
AZ102G
AZ102V
AZ102R
AZ102B

