



AM-60

**Compact DMM with
NCV & Logic Test**

Users Manual

- Mode d'emploi
- Bedienungshandbuch
- Manual d'Uso
- Manual de uso



AM-60

Compact DMM with NCV & Logic Test

Users Manual

English

Limited Warranty and Limitation of Liability

Your Amprobe product will be free from defects in material and workmanship for 1 year from the date of purchase. This warranty does not cover fuses, disposable batteries or damage from accident, neglect, misuse, alteration, contamination, or abnormal conditions of operation or handling. Resellers are not authorized to extend any other warranty on Amprobe's behalf. To obtain service during the warranty period, return the product with proof of purchase to an authorized Amprobe Test Tools Service Center or to an Amprobe dealer or distributor. See Repair Section for details. THIS WARRANTY IS YOUR ONLY REMEDY. ALL OTHER WARRANTIES - WHETHER EXPRESS, IMPLIED OR STATUTORY - INCLUDING IMPLIED WARRANTIES OF FITNESS FOR A PARTICULAR PURPOSE OR MERCHANTABILITY, ARE HEREBY DISCLAIMED. MANUFACTURER SHALL NOT BE LIABLE FOR ANY SPECIAL, INDIRECT, INCIDENTAL OR CONSEQUENTIAL DAMAGES OR LOSSES, ARISING FROM ANY CAUSE OR THEORY. Since some states or countries do not allow the exclusion or limitation of an implied warranty or of incidental or consequential damages, this limitation of liability may not apply to you.

Repair

All test tools returned for warranty or non-warranty repair or for calibration should be accompanied by the following: your name, company's name, address, telephone number, and proof of purchase. Additionally, please include a brief description of the problem or the service requested and include the test leads with the meter. Non-warranty repair or replacement charges should be remitted in the form of a check, a money order, credit card with expiration date, or a purchase order made payable to Amprobe® Test Tools.

In-Warranty Repairs and Replacement – All Countries

Please read the warranty statement and check your battery before requesting repair. During the warranty period any defective test tool can be returned to your Amprobe® Test Tools distributor for an exchange for the same or like product. Please check the "Where to Buy" section on www.amprobe.com for a list of distributors near you. Additionally, in the United States and Canada In-Warranty repair and replacement units can also be sent to a Amprobe® Test Tools Service Center (see next page for address).

Non-Warranty Repairs and Replacement – US and Canada

Non-warranty repairs in the United States and Canada should be sent to a Amprobe® Test Tools Service Center. Call Amprobe® Test Tools or inquire at your point of purchase for current repair and replacement rates.

In USA

Amprobe Test Tools

Everett, WA 98203

Tel: 888-993-5853

Fax: 425-446-6390

In Canada

Amprobe Test Tools

Mississauga, ON L4Z 1X9

Tel: 905-890-7600

Fax: 905-890-6866

Non-Warranty Repairs and Replacement – Europe

European non-warranty units can be replaced by your Amprobe® Test Tools distributor for a nominal charge. Please check the "Where to Buy" section on www.amprobe.com for a list of distributors near you.

Amprobe® Test Tools Europe

In den Engematten 14

79286 Glottertal, Germany

tel: +49 (0) 7684 8009 - 0

*(Correspondence only – no repair or replacement available from this address. European customers please contact your distributor.)

AM-60 Compact DMM with NCV & Logic Test

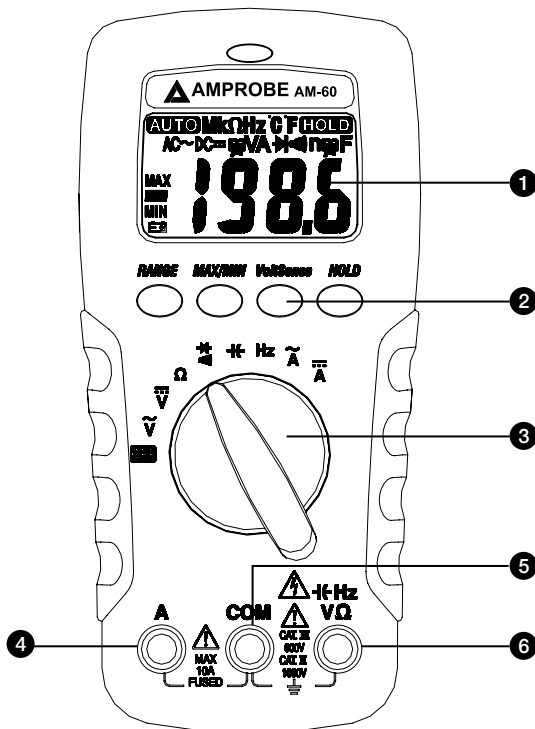













- 1 3-3/4 digits 2000 counts LCD display
- 2 Push-buttons for special functions & features
- 3 Selector to turn the Power On or Off and select Function
- 4 Input Jack (+) current function
- 5 Common (Ground reference) Input Jack (-) for all functions
- 6 Input Jack (+) for all functions except current function

AM-60 Compact DMM with NCV & Logic Test

CONTENTS





SYMBOLS	2
UNPACKING AND INSPECTION	3
INTRODUCTION	4
OPERATION	4
SPECIFICATION	8
MAINTENANCE	12
TROUBLE SHOOTING	12
Fuse Replacement	13
Battery Replacement	13

SYMBOLS

	Warning! Dangerous Voltage (Risk of electric shock).
	Caution ! Refer to the user's manual before using this Meter.
	Double Insulation or Reinforced insulation
	Alternating Current (AC).
	Direct Current (DC).
	Low battery indicator
	Fuse
	Ground (maximum permitted voltage between terminal and ground).
	Please remove all the test leads before performing maintenance, cleaning, battery replacement, fuse replacement, etc
	Complies with European Directives
	Conforms to relevant Australian standards
	Do not dispose of this product as unsorted municipal waste. Contact a qualified recycler for disposal

Warnings!

- Do not operate this meter in explosive gas (material), combustible gas (material) steam or filled with dust.
- When using test leads or probes, keep your fingers behind the finger guards.
- Remove test lead from Meter before opening the battery door or Meter case.
- Use the Meter only as specified in this manual or the protection by the Meter might be impaired.
- Always use proper terminals, switch position, and range for measurements.
- Never attempt a voltage measurement with the test lead inserted into the A input terminal.
- Verify the Meter's operation by measuring a known voltage. If in doubt, have the Meter serviced.

- Do not apply more than the rated voltage, as marked on Meter, between terminals or between any terminal and earth ground.
- Do not attempt a current measurement when the open voltage is above the fuse protection rating.
- Suspected open circuit voltage can be checked with voltage function.
- Only replace the blown fuse with the proper rating as specified in this manual.
- Use caution with voltages above 30 Vac rms, 42 Vac peak , or 60 Vdc. These voltages pose a shock hazard.
- To avoid false readings that can lead to electric shock and injury, replace battery as soon as low battery indicator  appears.
- Disconnect circuit power and discharge all high-voltage capacitors before testing resistance, continuity, diodes, or capacitance.
- Do not use Meter around explosive gas or vapor.
- To reduce the risk of fire or electric shock do not expose this product to rain or moisture.
- Disconnect the test leads from the test points before changing the position of the function rotary switch.
- Never connect a source of voltage with the function rotary switch in Ω /  /  / \sim A /  / Hz position.
- Do not expose Meter to extremes in temperature or high humidity.
- Never set the meter in \sim A function to measure the voltage of a power supply circuit in equipment that could result in damage the meter and the equipment under test.

UNPACKING AND INSPECTION

Your shipping carton should include:

- 1 AM-60 Meter
- 2 Test Leads
- 2 Battery (SIZE AAA, 1.5V)
- 1 User's Manual

If any of the items are damaged or missing, return the complete package to the place of purchase for an exchange.

INTRODUCTION

Multimeter AM-60 can be used to measure voltage, resistance, capacitance, frequency, current; It is an electronic measuring instrument that combines several measurement functions in one unit. AM-60 multimeter is portable hand-held devices useful for basic fault finding and field service work or a bench instrument which can measure to a very high degree of accuracy. They can be used to troubleshoot electrical problems in a wide array of industrial and household devices such as batteries, motor controls, appliances, power supplies, and wiring systems.

OPERATION

Measuring AC/DC Voltage And Frequency

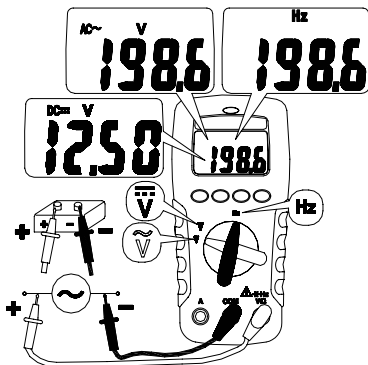

Testing for Continuity and Diode

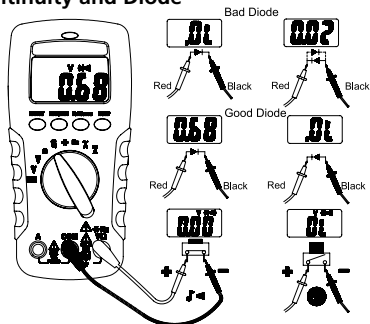

Resistance and Capacitance

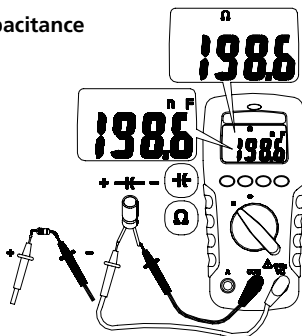

Note – To improve the measurement accuracy of small value capacitor, record the reading with the test leads open then subtract the residual capacitance of the Meter and leads from measurement.

$$C_{\text{UNKNOWN}} = C_{\text{MEASUREMENT}} - C_{\text{RESIDUAL}}$$

MIN MAX Record

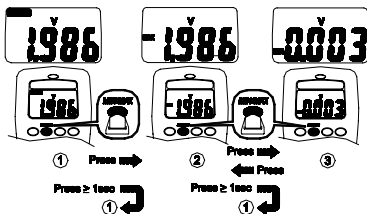

Measuring DC / AC Current

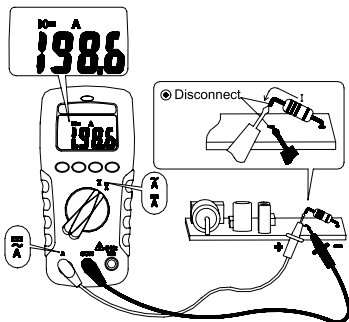

Display Hold

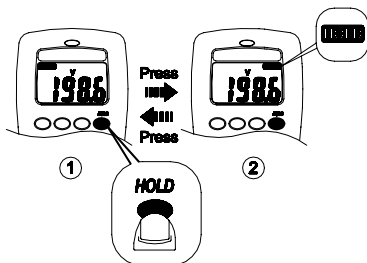

Manual Ranging and Auto Ranging

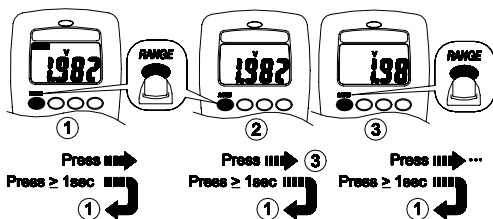

Auto Power Off (Battery Saver)

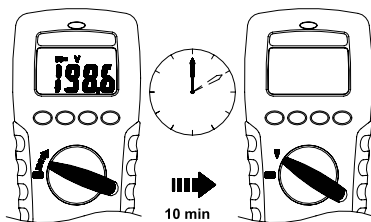

Disable Auto Power Off

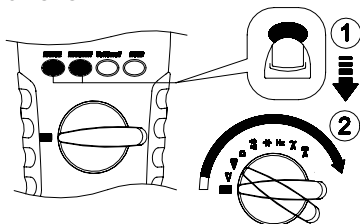

Non-Contact Voltage (Volt sense)

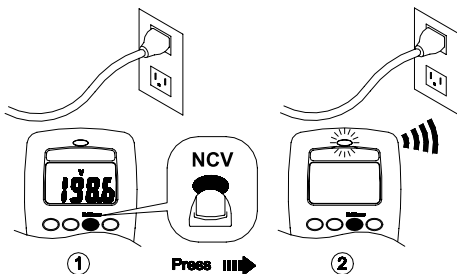

1. Volt sense switch will be activated on any function or at OFF status.
2. Test leads are not used for the Volt sense test.
3. Press the Volt sense button. The display goes black, a tone sounds and the red LED lights up to verify the instrument is operational. The Volt sense button must be held down to detect the presence of voltage without use of the leads.
4. If a voltage of 50V to 600V (50 to 500Hz) is detected near the top of meter a continuous tone sounds and the red LED near the top of meter illuminates.

SPECIFICATIONS

General Specifications

Display :	2000 counts.
Polarity Indication :	Automatic, positive implied, negative indicated.
Overrange Indication :	"OL" or "-OL".
Batteries Life :	Alkaline 250 hours
Low Batteries Indication :	"  " is displayed when the batteries voltage drops below operating voltage.
Auto Power Off :	Approx 10 minutes.
Operating Ambient :	Non-condensing $\leq 50^{\circ}\text{F}$, $51.8^{\circ}\text{F} \sim 86^{\circ}\text{F}$ ($\leq 80\%$ R.H) $87.8^{\circ}\text{F} \sim 104^{\circ}\text{F}$ ($\leq 75\%$ R.H), $105.8^{\circ}\text{F} \sim 122^{\circ}\text{F}$ ($\leq 45\%$ R.H)
Storage Temperature :	-4°F to 140°F , 0 to 80% R.H. when battery removed from Meter.
Temperature Coefficient :	$0.15 \times (\text{Spec. Accy}) / ^{\circ}\text{F}$, $< 64.4^{\circ}\text{F}$ or $> 82.4^{\circ}\text{F}$.
Measure :	Samples 2 times per second nominal.
Altitude :	6561.7 ft (2000m)
Safety :	Complies with EN61010-1, UL61010-1, IEC 61010-1,
V/Ω :	CAT.III. 600V, CAT.II. 1000V.
A :	CAT.III. 500V
Pollution degree :	2
Power Requirements :	1.5V x 2 IEC LR03, AM4 or AAA size
Dimensions (W x H x D) :	74mm (2.9") x 156mm (6.1") x 44mm (1.7")
Weight :	320g (0.71lb) including battery.
Accessories :	Battery (installed), Test leads and user manual.

Electrical Specifications

Accuracy is \pm (% reading + number of digits) at $23^{\circ}\text{C} \pm 5^{\circ}\text{C} < 80\%$ RH.

DC / AC Volts

Range	AC Accuracy
200.0mV *	Unspecified
2.000V *	$\pm(1.5\%+5\text{dgt})$ 50Hz ~ 300Hz
20.00V ~ 200.0V *	$\pm(1.5\%+5\text{dgt})$ 50Hz ~ 500Hz
750V AC / 1000V DC	

DC Accuracy :	$\pm(0.5\% + 2\text{dgt})$
Over voltage protection :	1000V DC or 750 V ACrms.
Input Impedance :	10M Ω // less than 100pF.
* CMRR / NMRR :	(Common Mode Rejection Ratio) (Normal Mode Rejection Ratio)
V_{AC} :	CMRR > 60dB at DC, 50Hz / 60Hz
V_{DC} :	CMRR > 100dB at DC, 50Hz / 60Hz NMRR > 50dB at DC, 50Hz / 60Hz

AC Conversion Type :

Average sensing rms indication.

AC conversions are ac-coupled, true rms responding, calibrated to the sine wave input.

* The minimum LCD reading is 1400 count in Auto Ranging Mode.

Crest Factor : C.F. = Peak / Rms

+ 1.5% addition error for C.F. from 1.4 to 3

+ 3% addition error for C.F. from 3 to 4

DC / AC Current

Range	DC Accuracy	AC Accuracy	Voltage Burden
2.000A	$\pm(1.0\% + 3\text{dgt})$	$\pm(1.5\% + 5\text{dgt})$ 50Hz ~ 500Hz *	2V max
10.00A **			

Overload Protection :

A input : 10A (500V) fast blow fuse

* **AC Conversion Type** : Conversion type and additional specification are same as DC/AC Voltage.

** Ampere Testing Duty Ratio Table

Ampere	Testing Time	Rest Time
10A	1min	10min
9A	2min	10min
8A	3min	10min
7A	4min	10min
6A	5min	10min
5A	Continually	N/A

Resistance

Range	Accuracy	Voltage Burden
200.0~200.0K Ω **	$\pm(0.7\% + 3 \text{ dgt})$	2V max
2.000M Ω **	$\pm(1.0\% + 3 \text{ dgt})$	
20.00M Ω *	$\pm(1.5\% + 3 \text{ dgt})$	

Open circuit Voltage: -1.3V approx.

* < 100 dgt rolling.

** The minimum LCD reading is 1400 count in Auto Ranging Mode.

Diode Check and Continuity

Resolution	Accuracy
10 mV	$\pm(1.5\% + 5 \text{ dgt})^*$

* For 0.4V ~ 0.8V

Max.Test Current : 1.5mA

Max. Open Circuit Voltage : 2V

Overload Protection : 600V rms.

Frequency

Range	Sensitivity	Accuracy
2000Hz ~ 200.0KHz	>1.5 Vac rms, <5 Vac rms	Frequency : 0.01%±1digit
2.000MHz ~ 20.00MHz	>2 Vac rms, <5 Vac rms	

Overload Protection : 600V rms.

Minimum pulse width : >25 ns

Duty cycle limits : >30% and <70%

Capacitance

Range	Accuracy	Overload Protection
2.000nF ~ 200.0μF	±(1.9% + 8 dgt)	600V rms
2.000mF *		

* < 10 dgt of reading rolling.

CE - EMC: EN61326-1.

This product complies with requirements of the following European Community Directives: 89/ 336/ EEC (Electromagnetic Compatibility) and 73/ 23/ EEC (Low Voltage) as amended by 93/ 68/ EEC (CE Marking). However, electrical noise or intense electromagnetic fields in the vicinity of the equipment may disturb the measurement circuit. Measuring instruments will also respond to unwanted signals that may be present within the measurement circuit. Users should exercise care and take appropriate precautions to avoid misleading results when making measurements in the presence of electronic interference.

MAINTENANCE

If there appears to be a malfunction during the operation of the meter, the following steps should be performed in order to isolate the cause of the problem.

1. Check the battery. Replace the battery immediately when the “” symbol appears on the LCD.
2. Review the operating instructions for possible mistakes in operating procedure.

Except for the replacement of the battery, repair of the meter should be performed only by a Factory Authorized Service Center or by other qualified instrument service personnel. The front panel and case can be cleaned with a mild solution of detergent and water. Apply sparingly with a soft cloth and allow to dry completely before using. Do not use aromatic hydrocarbons or chlorinated solvents for cleaning. If the meter is not to be used for periods of longer than 60 days, remove the batteries and store them separately.

Do not attempt to repair this Meter. It contains no user-serviceable parts. Repair or servicing should only be performed by qualified personnel.

TROUBLE SHOOTING

If the instrument fails to operate, check batteries and test leads etc., and replace as necessary. Double check operating procedure as described in this user's manual.

If the instrument voltage-resistance input terminal has subjected to high voltage transient (caused by lightning or switching surge to the system) by accident or abnormal conditions of operation, the series fusible resistors will be blown off (become high impedance) like fuses to protect the user and the instrument. Most measuring functions through this terminal will then be open circuit. The series fusible resistors and the spark gaps should then be replaced by qualified technician. Refer to the LIMITED WARRANTY section for obtaining warranty or repairing service.

Fuse Replacement

Refer to the following figure to replace fuse :

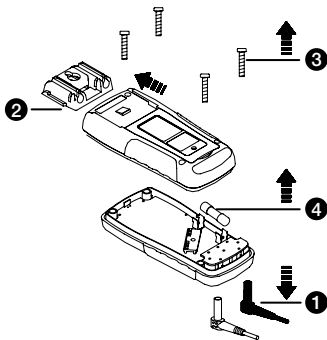

CAUTION:

- Use only a fuse with the amperage, interrupt, voltage, and speed rating specified.
- Fuse rating : 10A, 500V

Battery Replacement

Refer to the following figure to replace the batteries:

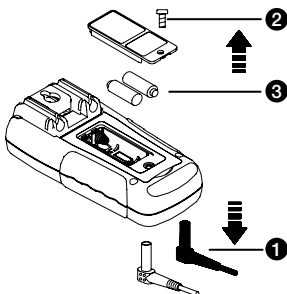

Visit www.Amprobe.com for

- Catalog
- Application notes
- Product specifications
- User manuals



Please Recycle