

DENVER®

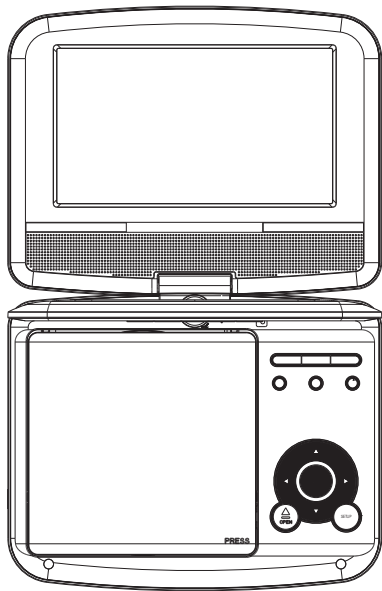

USER'S MANUAL MT-780

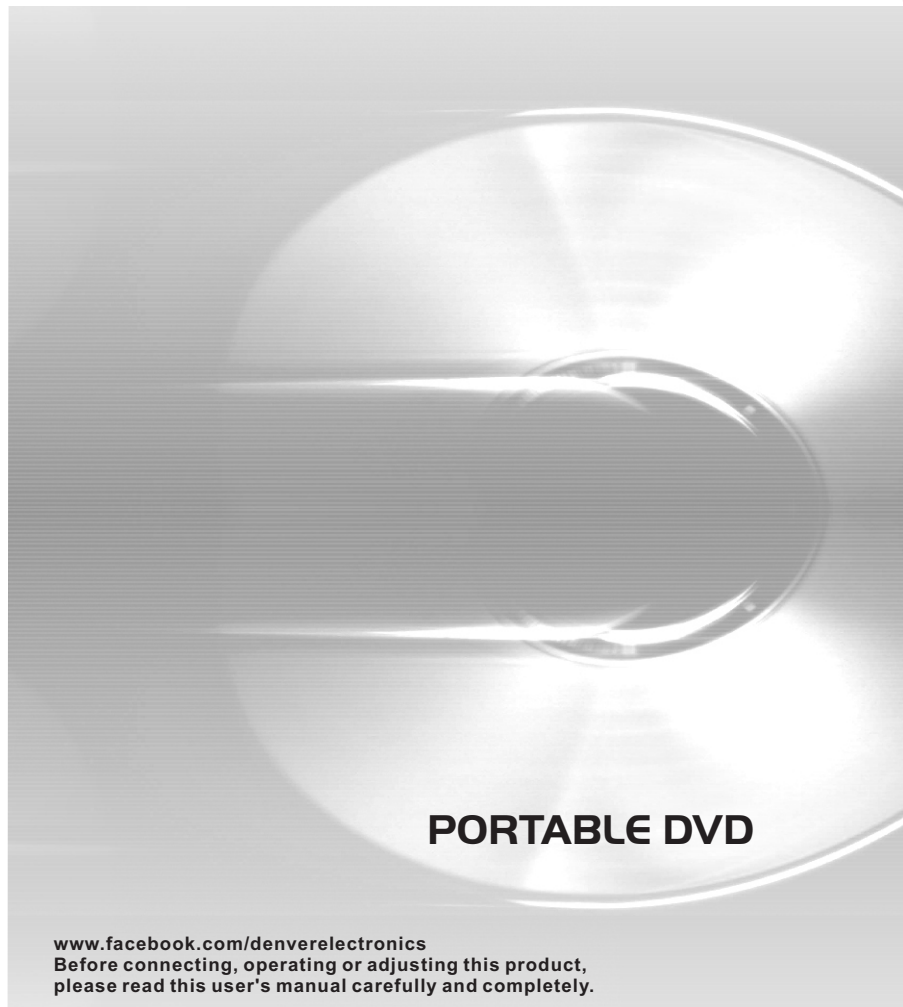

PORTABLE DVD

www.facebook.com/denverelectronics
Before connecting, operating or adjusting this product,
please read this user's manual carefully and completely.

Table of Contents

Contents

Table of Contents	P1
Important Safety Instructions	P2
Safety Precautions	P3
Identification of Controls	P4-P6
Main Unit.....	P4
Insert the battery.....	P4
Remote control unit.....	P5-P6
SETUP Menu Setting	P7-P9
General Setup Page.....	P7
Audio Setup Page.....	P7-P8
Video Setup Page.....	P8
Preference Page.....	P8-P9
Password Setup Page.....	P9
Parameters and specifications	P10
Electronical parameters.....	P10
System.....	P10
Battery Parameters.....	P10

Important Safety Instructions



Warning: To reduce the risk of electric shock, do not remove the cover or back. There are no user-serviceable parts inside. Refer servicing to qualified personnel.



Warning: To prevent fire or electric shock hazard, do not expose the unit to rain or moisture.

Do not expose the Adaptor and portable DVD to water (dripping or splashing) and no objects filled with liquids, such as vases, should be placed on the unit.

Keep the portable DVD away from direct sunlight and heat source such as radiators or stoves.

Do not block the ventilation openings. Slots and openings on the unit are provided for ventilation. The openings should never be blocked by placing your portable DVD on a cushion, sofa or other similar surface.

Do not place the portable DVD on unstable cart, stand, tripod, bracket or table. The unit may fall, resulting in possible damage or injury.

Never place heavy or sharp objects on the LCD panel or frame.

Only use the AC adapter included with portable DVD. Using any other adapter will void your warranty.

The plug of AC adaptor is used as the disconnect device, the disconnect device shall remain readily operable.

Unplug the power from the outlet when the unit is not in use.

Attention should be drawn to the environmental aspects of battery disposal.



CAUTION: Danger of explosion if battery is incorrectly replaced. Replace only with the same or equivalent type.



WARNING: The battery (battery or batteries or battery pack) shall not be exposed to excessive heat such as sunshine, fire or the like.



WARNING: Excessive sound pressure from earphones or headphones can cause hearing loss.



WARNING: Only use attachments/accessories specified provided by the manufacturer, the portable DVD is supplied by AC adapter, the AC adapter is used as disconnect device, the disconnect device shall remain readily operable.



Caution: Danger of explosion if battery is incorrectly replaced, replaced only with the same or equivalent type (Lithium battery)

This marking indicates that this product should not be disposed with other household wastes throughout the EU. To prevent possible harm to the environment or human health from uncontrolled waste disposal, recycle it responsibly to promote the sustainable reuse of material resources. To return your used device, please use the return and collection systems or contact the retailer where the product was purchased. They can take this product for environmental safe recycling.



Safety Precautions

WARNING
RISK OF ELECTRIC SHOCK
DO NOT OPEN



Warning: This digital video disc player employs a laser system. Use of controls, adjustments, or the performance of procedures other than those specified herein may result in hazardous radiation Exposure.



Warning: To prevent direct exposure to laser beam, do not open the enclosure. Visible laser radiation when open.



Warning: Never stare directly into the laser beam.



Caution: Do not install this product in a confined space such as a book case or similar unit.



Warning: when the unit using by child, parents must make sure to let the child understand all contents in Instruction book how battery using to guarantee using battery correctly all the time.



Warning: when find battery overheat, swell or dour, please stop using battery and contact service centre for getting replacement.



Warning: do not charging battery on the place of insufficient ventilation such as: mattress, sofa, cushion , soft mat.....



Warning: we will not take any responsibility if user incorrectly use battery, not following our warning instruction label on the battery case.



Warning: more than 250mm USB extension cord is prohibited to use for USB port

Notes on Copyrights:

It is forbidden by law to copy, broadcast, show, broadcast via cable, play in public, or rent copyrighted material without permission.

This product features the copy protection function developed by Macrovision. Copy protection signals are recorded on some discs. When recording and playing the pictures of these discs picture noise will appear. This product incorporates copyright protection technology that is protected by method claims of certain U.S. Patents and other intellectual property rights owned by Macrovision Corporation and other rights owners. Use of this copyright protection technology must be authorized by Macrovision Corporation, and is intended for home and other limited viewing uses only unless otherwise authorized by macrovision Corporation. Reverse engineering or disassembly is prohibited.

SERIAL NUMBER:

You can find the serial number on the back of the unit. This number is unique to this unit and not available to others. You should record requested information here and retain this guide as a permanent record of your purchase.

Model No. _____
Serial No. _____
Date of Purchase _____

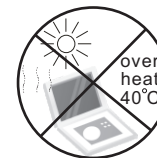
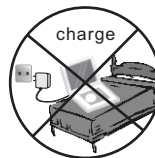

Identification of Controls

Main Unit

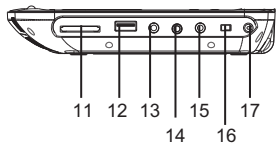
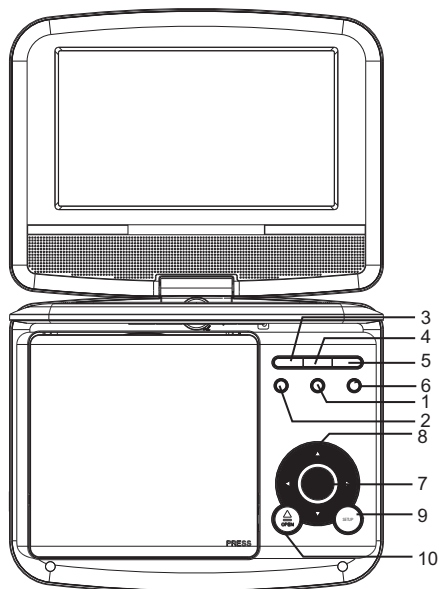

1. VOL+
2. VOL-
3. ►|| PLAY/PAUSE
4. ■ STOP
5. SOURCE
6. MENU
7. ENTER
8. ▲/▼/◄/► (up/down/right/left)
Select an item in the menu.OK key confirms menu selection.
when playing,VCD,DVD,if available:
right: fast forward
left: fast reverse
up: previous track
down: next track
9. SETUP
10. OPEN
- 11.SD/MMC
- 12.USB
13. AV OUT
14. ☎ Earphone Socket
15. COAXIAL
- 16.ON/OFF
- 17.DC IN 9-12V

Insert the battery

1.Open the battery door.

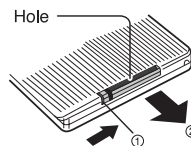

2.Insert battery.

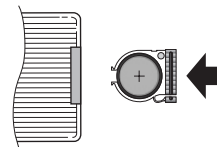

NOTES:

Remove battery during storage or when you are not using the DVD player for a long time.

Identification of Controls

Remote control unit

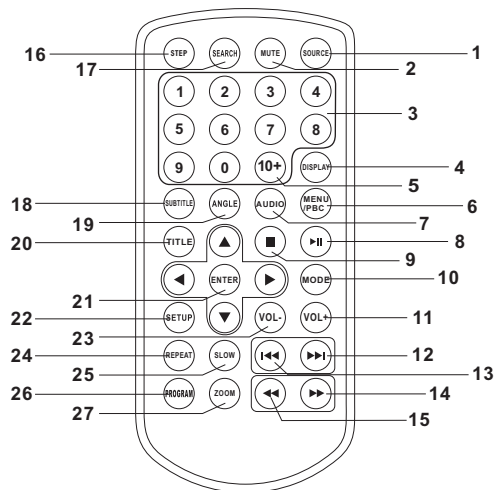

1. SOURCE

DVD/CARD/USB.

2. MUTE

Disable Audio output.

3.0-9 NUMBER BUTTON

Selects numbered items in a menu.

4.DISPLAY

To display the playtime and status information.

5.10+ BUTTON

In order to select a track 10 or greater, first press 10+, For example; select track 12, first press 10+, and then press number 2 button.

6. MENU/PBC

Return to DVD root menu(DVD).
PBC on/off switch (VCD) .

7.AUDIO

DVD:Press AUDIO repeatedly during playback to hear a different audio language or audio track, if available.

CD/VCD: Press AUDIO repeatedly during playback to hear a different audio channel (Left,Right,Mix,Stereo).

8.PLAY/PAUSE

Press PLAY/PAUSE once to pause playback, pressing PLAY/ PAUSE second time will resume the playback.

9.STOP

When this button is pressed once, the unit records the stopped point,from where playback will resume if PLAY (▶) is pressed after wards. But if STOP button is pressed again instead of PLAY (▶) button, there will be no resume function.

10.MODE

Set LCD parameter(adjust bightness, contrast,and saturation).

11.VOL+

23.VOL-

Adjust volume.

12.Forward Skip

Go to next chapter/ track.

13.Reverse Skip

Go to previous chapter/ track to the beginning.

14. ▶▶ BUTTON

Press ▶▶ BUTTON allow skipping ahead at 5-level speed(X2-> X4->X8->X16->X32->PLAY), press PLAY button return to normal playback.

Identification of Controls

Remote control unit

15. ◀◀ BUTTON

Press ◀◀ BUTTON allow skipping back at 5-level speed(X2->X4->X8->X16->X32->PLAY), press PLAY button return to normal playback.

16. STEP

Step the motion in DVD mode.

17. SEARCH

Goto time point , title or chapter you want in DVD Mode.

18. SUBTITLE

Press SUBTITLE repeatedly during playback to hear a different subtitle languages.

19. ANGLE

DVD: Press ANGLE will change the view angle, on DVDs that support this feature.

20. TITLE

Return to DVD title menu

21. ENTER

Confirms menu selection..

22. SETUP

Accesses or removes setup menu.

24. REPEAT

Press REPEAT during playback to select a desired repeat mode.

DVD: you can play select repeat chapter/title/off.

VCD: you can select repeat single/all/off.

CD: you can select repeat single/folder/off.

25. SLOW

Press Slow button repeatedly to enter slow playback, and cycle between different speeds. The speeds are 1/2, 1/4, 1/8, 1/16, and normal.

26. PROGRAM

DVD/VCD: The program function enables you to store your favourite tracks from the disc. Press PROGRAM button ,then PROGRAM MENU will appear on screen, now you can use the number key to direct input the titles, chapters or tracks number and select PLAY option. TO resume normal playback, press PROGRAM and select clear program option on the program menu, press PROGRAM again to exit program menu.

27. ZOOM

DVD/VCD: Use ZOOM to enlarge or shrink the video image.

1. Press ZOOM during playback or still playback to activate the Zoom function. The square frame appears briefly in the right bottom of the picture.

2. Each press of the ZOOM button changes the TV screen in the following sequence:

2X size → 3X size → 4X size → 1/2 size → 1/3 size → 1/4 size → normal size

JPEG: Use ZOOM to enlarge or shrink the picture.

1. Press 'ZOOM' .

2. Used "▶▶" to enlarge, or "◀◀" to shorten the picture.

Use the ▲▼◀▶ button to move through the zoomed picture.

SETUP Menu Setting

General Setup Page

Press SETUP button to get the setup menu. Use direction buttons ▲▼◀▶ to select the preferred item. After finishing settings, press SETUP again to normal display.

The following menu items can be changed:

GENERAL: selects the GENERAL PAGE menu.

AUDIO: selects the AUDIO PAGE menu.

VIDEO: selects the VIDEO PAGE menu.

PREFERENCE : selects the PREFERENCE PAGE menu.

PASSWORD: selects the PASSWORD PAGE menu.

General Setup Page

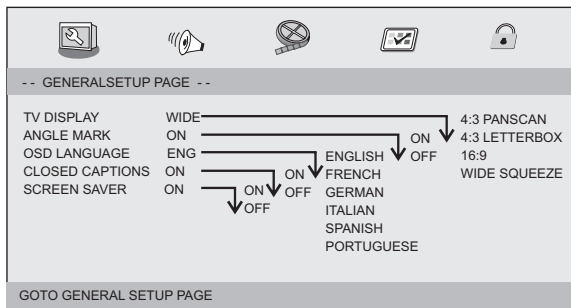

TV DISPLAY: selects the aspect ratio of the playback picture.

4:3 PANSCAN: if you have a normal TV and want both sides of the picture to be trimmed or formatted to fit your TV screen.

4:3 LETTERBOX: if you have a normal TV. In this case, a wide picture with black bands on the upper and lower portions of the TV screen will be displayed.

16:9: wide screen display.

Wide Squeeze: Set screen mode to 4:3.

Angle Mark

Displays current angle setting information on the right hand corner of the TFT screen if available on the disc.

OSD Language

You can select your own preferred language settings.

Closed Captions

Closed captions are data that are hidden in the video signal of some discs. Before you select this function, please ensure that the disc contains closed captions information and your TV set also has this function.

Screen Saver

This function is used to turn the screen saver On or Off.

Audio Setup Page

Audio Setup Page

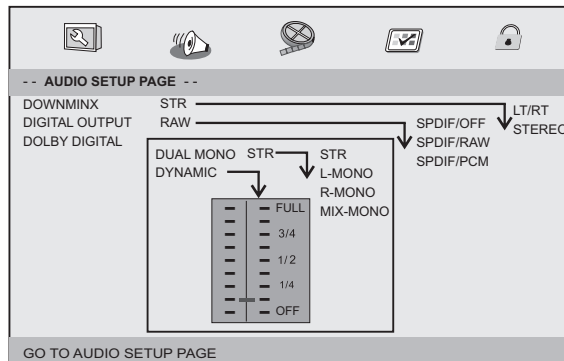

SETUP Menu Setting

Audio Setup Page

Downmix

This options allows you to set the stereo analog output of your DVD Player.

→ **LT/RT** :Select this option if your DVD Player is connected to a Dolby Pro Logic decoder.

→ **Stereo** :Select this option when output delivers sound from only the two front speakers.

Digital Output

The function is used to select the SPDIF Output:SPDIF Off,SPDIF /RAW,SPDIF/PCM.

→ **SPDIF Off**: Turns off the SPDIF output.

→ **SPDIF/RAW**: If you have connected your DIGITALAUDIO OUT to a multi-channel decoder/receiver.

→ **SPDIF/PCM**: Only if your receiver is not capable of decoding multi-channel audio.

Dolby digital

The options included in Dolby Digital Setup are: 'Dual Mono ' and 'Dynamic '.

Dual Mono

→ **Stereo**:Left mono sound will send output signals to Left speaker and Right mono sound will send output signals to Right speaker.

→ **L-Mono**:Left mono sound will send output signals to Left speaker and Right speaker.

→ **R-Mono**:Right mono sound will send output signals to Left speaker and Right speaker.

→ **Mix-Mono**:Left and Right mixed mono sound will send output signals to Left and Right speakers.

Dynamic

Dynamic range compression.

Video Setup Page

Video Setup Page

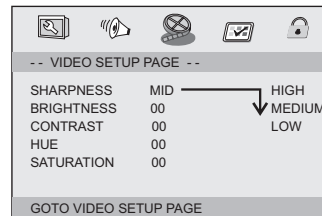

Sharpness,Brightness,Contrast,Hue,Saturation:setting the video quality.

Preference Page

Preference Page

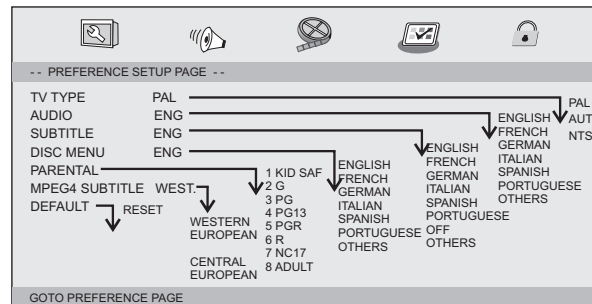

TV Type

Selecting the colour system that corresponds to your TV when AV outputs.This DVD Player is compatible with both NTSC and PAL.

SETUP Menu Setting

Preference Page

PAL - Select this if the connected TV is PAL system. It will change the video signal of a NTSC disc and output in PAL format.

NTSC - Select this if the connected TV is NTSC system. It will change the video signal of a PAL disc and output in NTSC format.

Auto: Change the video signal output automatic according to the playing disk format.

Audio: Selects a language for audio (if available).

Subtitle: Selects a language for subtitle (if available).

Disc Menu: Selects a language for disc menu (if available).

Parental

Some DVDs may have a parental level assigned to the complete disc or to certain scenes on the disc. This feature lets you set a playback limitation level. The rating levels are from 1 to 8 and are country dependent. You can prohibit the playing of certain discs that are not suitable for your children or have certain discs played with alternative scenes.

MPEG4 SUBTITE: Select the MPEG4 subtitle.

Default: Back to the factory setting.

Password Setup Page

Password Setup Page

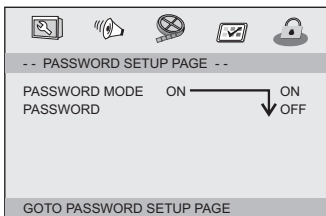

Password mode: Set password mode on/off. If set to off, change parental level will not check password.

Password Setup Page

Password: select the menu password change page.

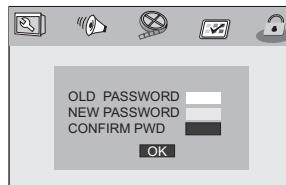

OLD PASSWORD: Enter the OLD password, (Factory setting is 1369), and the cursor will jump automatically to NEW PASSWORD

NEW PASSWORD: Enter the NEW password. Enter 4 digits from the remote control unit numeric buttons, and the cursor will automatically jump to CONFIRM PASSWORD.

CONFIRM PASSWORD: Confirm the NEW password by entering it again. If the confirmation is incorrect, the cursor will stay in this column. After entering, the correct new password again, the cursor will jump automatically to OK.

OK: When cursor is on this button, press ENTER key to confirm setting.



Note: If the password has been changed, the parental and disc lock code will also be changed.

The default password (1369) is always active even the password has been changed.

Parameters and specifications

Electronical parameters

Item		Standard requirement
Power requirements		: AC 100-240 V , 50/60 Hz
Power consumption		: <10W
Operating humidity		: 5 % to 90 %
Output	VIDEO OUT	:1 V _{p-p} (75Ω)
	AUDIO OUT	:1.4 V _{rms} (1 KHz, 0 dB)
	Audio	:Speaker:1WX2,Headphones output

System

Laser	:Semiconductor laser, wavelength 650 nm
Signal system	: NTSC / PAL
Frequency response	: 20Hz to 20 kHz(1dB)
Signal-to-noise ratio	:More than 80 dB (ANALOG OUT connectors only)
Dynamic range	:More than 85 dB (DVD/CD)

 Note: Design and specifications are subject to change prior notice.

Battery Parameters

Battery Specifications:

Output: 7.4V

Charge / Discharge Time:

Standard charge time: 3h ~ 4h

Storage and work circumstances:

1. Storage circumstances	Temperature	Humidity	
	6 months	-20°C ~ +45°C	65±20%
1 week	-20°C ~ +65°C	65±20%	
2.Work circumstances	Temperature	Humidity	
	Standard charge	0°C ~ +45°C	65±20%
	Standard discharge	-20°C ~ +65°C	65±20%

ALL RIGHTS RESERVED, COPYRIGHT DENVER ELECTRONICS A/S

DENVER®

www.denver-electronics.com

CE



Electric and electronic equipment and included batteries contains materials, components and substances that can be hazardous to your health and the environment, if the waste material (discarded electric and electronic equipment and batteries) is not handled correctly.

Electric and electronic equipment and batteries is marked with the crossed out trash can symbol, seen below. This symbol signifies that electric and electronic equipment and batteries should not be disposed of with other household waste, but should be disposed of separately.

As the end user it is important that you submit your used batteries to the appropriate and designated facility. In this manner you make sure that the batteries are recycled in accordance with legislature and will not harm the environment.

All cities have established collection points, where electric and electronic equipment and batteries can either be submitted free of charge at recycling stations and other collection sites, or be collected from the households. Additional information is available at the technical department of your city.

Please fill the blank with the model number of this player for future reference

Imported by:
Inter Sales A/S
Stavneagervej 22,8250 Egaa,Denmark
www.facebook.com/denverelectronics