

## Table of Contents

Introduction.....	3
Controller Features.....	4
<b>MOUNTING AND INSTALLATION .....</b>	<b>9</b>
Mounting The Controller .....	9
Controller Connections – Ac Power .....	9
Electrical Grounding For The Controller .....	10
Controller Connections – Valves And Field Wiring .....	11
Master Valve And Pump Wiring Options .....	11
Electrical Connections For A Master Valve .....	12
Normally Closed Master Valve Operation .....	12
Simultaneous Normally Closed Master Valve and Pump Operation.....	12
Independent Normally Closed Master Valve and Pump Operation.....	14
Normally Open Master Valve.....	14
Normally Open Master Valve and Pump Operation.....	15
Flow Sensor Installation .....	15
Sensor Wiring .....	16
Tapping Wires To Locate Valves In The Field .....	16
Remote Control Capability .....	16
Electrical Specifications .....	17
<b>KEY OPERATIONS .....</b>	<b>19</b>
Function Keys.....	20
Execute Keys .....	21
Data Keys.....	22
<b>WORDS AND TERMS USED IN THE DISPLAY .....</b>	<b>23</b>
Automatic Mode .....	28
Rain Mode .....	28
Programmable Rain .....	29
<b>QUICK AND BASIC PROGRAMMING.....</b>	<b>31</b>
Set Time.....	31
Program.....	31
Program Selection.....	31
Program Clear .....	32
Watering Day Selections .....	32
Water Days .....	32
Skip Days.....	33
Stations And Watering Times.....	33
Stations (for a conventional program) .....	34
Quick Stations (for a conventional program) .....	35
Cycle And Soak .....	35
Stations (for a cycle and soak program) .....	36
Quick Stations (for a cycle and soak program) .....	37
Percentage.....	38

Start Times And Automatic Program Overlap Protection .....	39
Start Times .....	40
Reviewing Programs And Totalizer .....	41
<b>MANUALLY ACTIVATED FUNCTIONS WITH EXAMPLES .....</b>	<b>43</b>
Manual Program .....	43
Manual Station .....	43
Manual Master Valve .....	44
Manual System Check/Syringe Cycle .....	44
Monitoring Station Flow .....	45
Fault Detection Overview .....	45
Wiring Fault .....	46
Flow Main Fault .....	46
Flow Unscheduled Fault .....	47
Flow Station Fault .....	48
<b>ADVANCED SETUP PROGRAMMING .....</b>	<b>49</b>
Master Valve (MV) .....	50
Type Of Master Valve .....	50
Pump .....	51
Stack Or No Stack .....	51
Delay .....	52
Security Code .....	52
Sensor .....	53
Alarm .....	54
Cycle And Soak .....	55
Flow Sensor Features Enabled/Disabled .....	55
Pipe .....	56
Main Line Flow Limit .....	56
Unscheduled Flow Limit .....	56
Flow Check Delay .....	57
Totalizer .....	57
Flow Percentage .....	58
Limits .....	59
Station Limits Using Learn Mode .....	59
Setting Station Limits .....	60
<b>TROUBLESHOOTING .....</b>	<b>65</b>
<b>APPENDIX A .....</b>	<b>66</b>
<b>INDEX .....</b>	<b>67</b>

# RME HAWK

*Congratulations . . .* you have chosen one of the most advanced irrigation controllers available. Rain Master has taken great pride and patience in developing and building the most trouble-free controllers in the irrigation industry. Your RME HAWK has many high-end features. Features such as accurate, economical flow sensing, and cycle and soak programming are yours at the press of a button. In addition, your new RME HAWK controller maintains full support of independent pump and normally closed or normally open master valves. All this was designed to protect one of our most precious resources...water... as well as your bottom line!

To take full advantage of the many features available in your RME HAWK controller, please take a few minutes and read through your User Manual. For those who do not have the time, a Quick Reference sheet is provided. This sheet will allow you to perform many of the basic functions required in programming and operating your controller.



## CONTROLLER BASIC FEATURES

- No batteries to replace, ever.
- Easy to identify and use keypad for ease of programming and review.
- Multiple displays provide a truly simple way of programming and information recall.
- The Review feature brings all the information for a given program(s) to the displays with simple push of the Review Button.
- Non-volatile memory holds the program(s) indefinitely during power outages or seasonal shut down.
- A "real time" clock holds the actual time during power outages without batteries. This eliminates the need to reset the clock every time the power goes out.
- Four (4) completely independent programs with five (5) start times, for a total of 20 possible start times per day.
- Watering time(s) for each station can be set from 1 minute to 9 hrs 59 minutes in one-minute increments.
- Quick Stations allow for rapid programming of a block of stations with the same watering time.
- Water Days for each program may be based on seven-day week or a skip-by-day routine allowing a program to skip from 1 to 30 days between watering.
- Programmable rain shut down allows you to select the number of days the controller will stay off (in rain shut down mode) before it goes back into the automatic mode.
- Manually activated system check/syringe cycle allows you to sequentially run stations for a user selectable time from 1 minute to 9 minutes.
- Manually activated program cycle allows you to run a program independent of its programmed start time and water days.
- Manually activated station cycle allows you to run a single station for a selected time.
- Built-in remote control capability for Rain Master Remotes.
- Automatic field wire fault detection enables the controller to sense a short in the field wire and instantly turn off that station, report the fault and move to the next programmed station. No fuses or reset button to be concerned with.
- Rain Switch (auto-off) turns off all stations without disturbing the program(s).
- Available for 120 VAC, 50/60 HZ or 220/240 VAC 50/60 HZ power.
- Heavy duty 18-gauge jet coat, powder coated steel enclosure for outdoors or indoors use.
- Two convenient sized enclosures for easy installation of field wires.
- Extra heavy-duty lightning and surge protected models available for areas where lightning is a concern.
- Outdoor pedestal mount available for all models.
- C-UL and FCC approved.
- Percentage key allows you to increase or decrease all station runtimes on a percentage basis in 1% increments from 0% to 300% by program.
- Built-in self-test allows you to test the entire controller and field wires for faults, thereby ensuring that the entire system is functioning correctly.
- Comes with a limited 5-year warranty.

## CONTROLLER ADVANCED FEATURES

- Ability to select cycle-and soak programming or conventional programming on a per-program basis. This feature includes:
  - Ability to set RUNTIME, MAX CYCLE TIME and SOAK time on a per station basis.
  - Automatic minimization of the water window by intelligently scheduling station starts if and when other stations are satisfying their SOAK TIMES.
  - QUICK STATIONS support for Cycle and Soak.
  - For Total Runtime of a program in REVIEW, cycle and soak programs intelligently display Total Runtime considering all soak delays, optimized program, water budget percentage and interstation delay.
- Flow rate monitoring including:
  - Main Line Break flow detection.
  - Unscheduled flow detection.
  - Station upper-limit flow detection.
  - Programmable flow check delay (1-6 minutes).
  - Monitor and display measured station flow in GPM.
  - Automatic flow LEARN mode for setting individual station limits or manual entry or semiautomatic monitor/set mode.
  - Global percentage adjust to automatically factor upper flow limits for all stations.
  - Automatic station advancement for station overflow.
  - Audible and visual alert for all flow violations.
  - Intelligent upper-limit processing for concurrent station operation.
  - Automatic closure of normally open Master Valve on Main Line Break or Unscheduled Overflow.
- Totalizer feature for tracking water usage in gallons to pinpoint specific water savings and conservation efforts.
- Ability to select usage of the Master Valve per program.
- Ability to select a Normally Open or Normally Closed Master Valve.
- Ability to select usage of a Pump on a per program basis.
- Programmable Security Access code.
- Usage of a rain sensor on a per program basis.
- Programmable interstation delay from 0 to 255seconds in 1-second increments.

## USER PROGRAMMABLE FEATURES (SETUP)

The following features can be easily selected or reconfigured by a single push of a button (SETUP key).

- Programmable Master Valve allows you to program a Master Valve to go on by program.
- Programmable type of Master Valve allows you to select either a Normally Closed Master Valve or a Normally Open Master Valve.
- Programmable Pump allows you to program a Pump (independent of the Master Valve) to go on by program.
- Programmable stacking or no stacking of programs allows you to have programs run one after the other (Stack Mode) or at the same time (No Stack Mode).
- Programmable timer delay between stations allows you to program a time delay from 0 to 255 seconds (4 minutes 15 seconds) to allow slow-closing valves to completely shut off.
- Programmable security code allows you to enter a 1 - 4 digit number as a security code which will prevent entry by unauthorized personnel.
- Programmable sensor allows you to have a sensor device enabled or disabled for each program.
- Programmable alarm allows you to either enable or disable an audible alarm in the event of a flow limit violation or a field wire fault detection.
- Programmable cycle and soak allows you to select each program to be either a cycle and soak program or not.
- Programmable flow allows you to enable or disable the flow sensor features.
- Programmable pipe size allows you to select the pipe size for the flow sensor.
- Programmable main line flow limit allows you to set an upper flow limit from 1 to 999 GPM. This limit defines the maximum allowable controller flow for scheduled irrigation.

- Programmable unscheduled flow limit allows you to setup an upper flow limit from 0 to 999 GPM. This limit defines the maximum allowable flow when there is no scheduled irrigation, e.g.. usage of manual quick coupler devices.
- Programmable flow check delay allows you to set up a delay after any station changes, from 1 minute to 6 minutes, during which time no flow limits are checked.
- Total Gallons allows you to view the total accumulated gallons and to clear the total accumulated gallons.
- Programmable flow percentage allows you to set up a global percentage from 5% to 80% which will be used as an adjustment on all station upper flow limits.
- Programmable station upper flow limits allows you to individually set an upper flow limit from 0 GPM to 500 GPM for each station or to run a watering profile during which the upper flow limit for each station will be automatically set based on the measured flow and the global programmable flow percentage.

**THIS PAGE INTENTIONALLY LEFT BLANK**



## MOUNTING AND INSTALLATION

### CONTROLLER PLACEMENT

**WARNING:** Do not drill holes in the controller's case. It has all the holes necessary for mounting it on a wall or pedestal. Drilling holes in the unit will cause metal chips to mix with the electronics and this will cause the unit to malfunction. If, for some reason, it is absolutely necessary to drill additional holes in the unit, carefully remove all the electronics prior to doing so.

Controllers are suitable for indoor/outdoor environment. It is lockable, dust-free and rain resistant. Outdoors the controller should be placed in a shaded and dry environment not subject to direct sprinkler spray or continuous heavy moisture. Additionally, a pedestal (PED 1) is available for outdoor controllers; contact your Rain Master distributor.

### MOUNTING THE CONTROLLER

1. On an upright, flat and secure surface, place the mounting bracket at eye level and fasten securely.
2. Mate the bracket on the back of the controller to the mounted bracket and hang the controller.
3. Secure the bottom of the controller by placing a screw through the hole located in its back wall at bottom center.

### CONTROLLER CONNECTIONS – AC POWER

1. Refer to Figure 1 - Power and Field Wiring.
2. Mount controller.
3. Place Rain Switch in “No Watering” position.
4. Remove lower panel.
5. Using #10-gauge or heavier copper wire, connect ground screw to ground rod or grounded water pipe using a ground rod clamp. The wire should be as short as possible with no sharp bends or kinks. If multiple clocks are being installed in the same location, use a ground rod for each and contact the factory for the RMIS pamphlet on proper grounding techniques.
6. Thread conduit onto transformer.
7. Connect supply line grounded conduit to conduit.
8. Connect 120 V 50/60Hz supply line to transformer wires within the conduit
9. Install gasket and cover onto conduit with 2 screws.
10. Follow all appropriate electrical wiring codes.  
Replace the lower panel and place the Rain Switch in “Automatic Watering” position after field valve wiring is complete.

## ELECTRICAL GROUNDING FOR THE CONTROLLER

Proper electrical grounding is required to ensure safety to you, as well as to protect the controller electronics in the event of electrical line surges or lightning. In areas where lightning is a common occurrence, it is strongly recommended to use the HAWK model HK-T.

### Grounding Instructions

1. Mount the controller as close as possible to the grounding rod, so that the #10 grounding wire from the controller to the ground rod is as short as possible. Ensure the grounding wire is free of nicks and bends.
2. Use a grounding rod clamp to secure grounding wire to grounding rod. Be sure all surfaces are clean of oxides and dirt, and that all connections are solid and secure.
3. In areas of very dry soil or sand, it may be necessary to "Dope" the grounding rod. Contact your Rain Master distributor or Rain Master for grounding pamphlet, "RMIS Grounding".
4. Should the 8' grounding rod not penetrate completely into the soil it is acceptable to put it into the ground on a slight angle. It is important that the rod be a full 8' into the ground, with only enough of the rod showing to clamp the wire on. Should other grounding installation requirements be necessary, contact your distributor or Rain Master.

**Note:** *It is important to check the resistance periodically to ensure it is not greater than 10 ohms. Contact your Rain Master Distributor for details.*

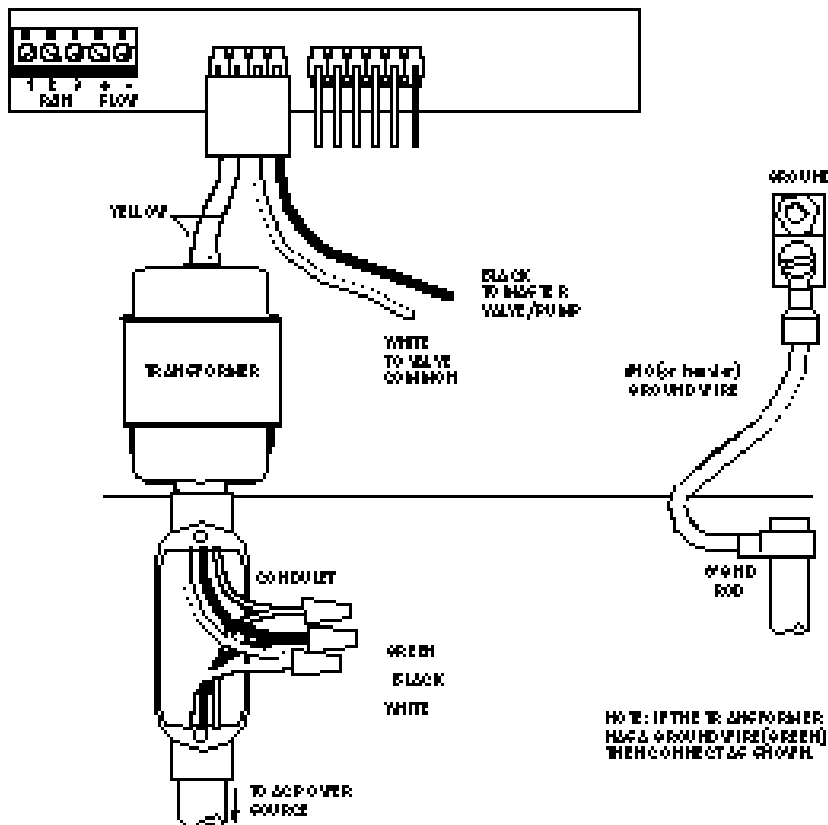

**FIGURE 1. POWER AND FIELD WIRING**

## CONTROLLER CONNECTIONS – VALVES AND FIELD WIRING

The controller utilizes quick disconnects and color coded wires. The wires are 24" long and each end must be stripped and attached to the corresponding field wire. HAWK HK and HK-T model controllers come equipped with terminals to which the field wires are directly connected. Unused wires should be taped off to prevent shorting.

The station numbers are labeled just above the quick disconnects behind the lower panel of the controller. Simply match the station's wire to the appropriate field wire. Note that the controller's COMMON wire is WHITE and the MASTER VALVE/PUMP is BLACK.

Should it be necessary to detach the Quick Disconnect blocks from the printed circuit board, hold the plastic assembly and pull down gently but firmly.

**Note:** *When reattaching the Quick Disconnect, be careful to make sure that the lip at the top of the plastic connector is facing you as you push the connector onto the pins. Additionally, be sure to match the Quick Disconnect blocks with the corresponding color as labeled on the bottom of the printed circuit board.*

## MASTER VALVE AND PUMP WIRING OPTIONS

The RME HAWK provides a variety of control options when selecting a Master Valve and Pump. Because the pump and master valve can be assigned to any program, and the master valve can be either a Normally Open or Normally Closed configuration, virtually any system can be accommodated. For example, drip programs may be SETUP in one or more programs, which don't use the pump, while large rotors may be in a pump-defined program. The following table summarizes the options which are available, the installation diagrams required to achieve these options, and the corresponding SETUP (programming of the RME HAWK using the SETUP key). For detailed information on SETUP, please refer to ADVANCED SETUP PROGRAMMING beginning on page 47.

MASTER VALVE AND PUMP WIRING OPTIONS MATRIX

Option	Normally Closed MV	Normally Open MV	Pump Used	Reference Wiring Figure	SETUP MV Usage per Program	SETUP MV Type	SETUP Pump Usage per Program
1*	✓	—	Never	2	1, 2, 3, 4	NC	None
2*	✓	—	Always	3 or 4	1, 2, 3, 4	NC	None
3	✓	—	Sometime	5	1, 2, 3, 4	NC	As Needed
4	—	✓	Never	2	1, 2, 3, 4	NO	None
5	—	✓	Always	5	1, 2, 3, 4	NO	1, 2, 3, 4
6	—	✓	Sometime	5	1, 2, 3, 4	NO	As Needed

\* No SETUP programming required (factory default settings).

**Note:** *Although Option 2 shows that a pump is in the system, the SETUP programming indicates that the PUMP should not be programmed. This preserves Station 1 as a station output.*

## ELECTRICAL CONNECTIONS FOR A MASTER VALVE

The RME HAWK allows you to SETUP the Master Valve (MV) output as either a Normally Open or Normally closed configuration. When used in the Normally Closed mode, the Master Valve line is a source of 24 VAC power. It is active whenever any station in the controller is on. For Normally Open Master Valves, the controller supplies 24 VAC only when either a Main Line Fault or Unscheduled Flow Fault occurs.

### Normally Closed Master Valve Operation

If you have a Master Valve which requires activation to open, and no pump, connect the master valve solenoid to the MV and Valve Common terminals as shown in Figure 2. If more than one clock is going to control the Master Valve, the clocks must be isolated from each other. Contact RMIS for the pamphlet on multiple clock installations. During SETUP, select the NC (Normally Closed) Valve type for all programs (1, 2, 3, 4).

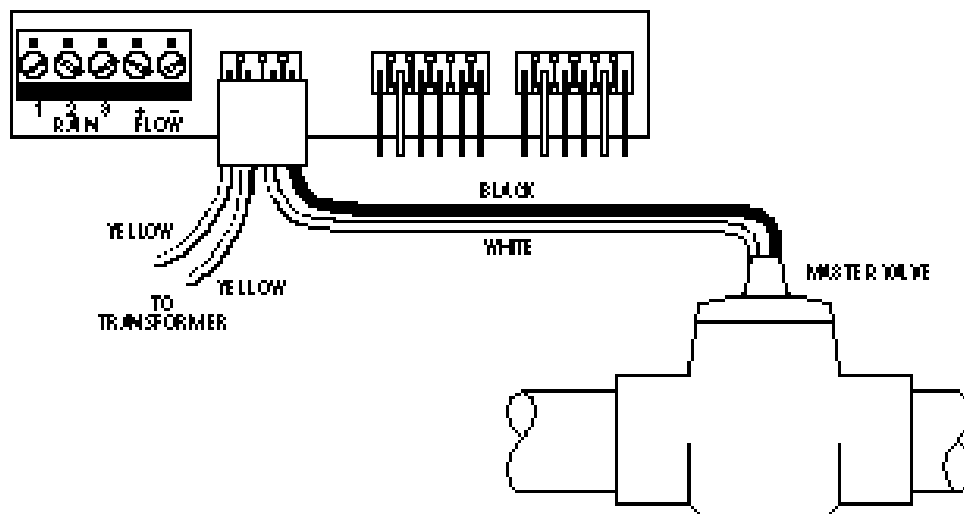

**FIGURE 2. MASTER VALVE WIRING (EITHER NORMAL IT OPEN OR NORMAL IT CLOSED)**

### Simultaneous Normally Closed Master Valve and Pump Operation

If you have a Master Valve which requires activation to open, and a pump which is always needed whenever irrigating, connect BOTH the master valve solenoid and pump starter to the MV and Valve Common terminals as shown in Figure 3. If the pump starter operates on 24 volts AC and the combination of the Master Valve Solenoid and Pump Starter require more than 1 amp, you will need an isolation relay (Rain Master part: RLY1 or equivalent) and an additional source of 24 VAC (see Figure 4). During setup, select the NC Valve type for all programs which require the Master Valve and Pump. DO NOT select pump operation.

If the pump starter requires 120 VAC, you will also need an isolation relay (RLY1).

If more than one clock is going to control the Master Valve and pump, the clocks must be isolated from each other. Contact RMIS for the pamphlet on multiple clock installations.

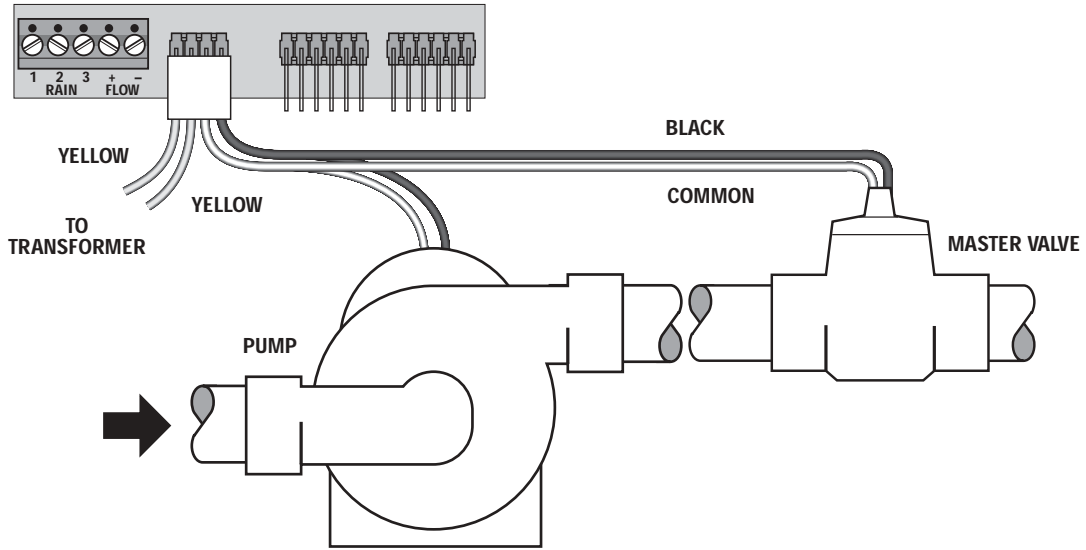

FIGURE 3. SIMULTANEOUS NORMALLY CLOSED MASTER VALVE AND PUMP

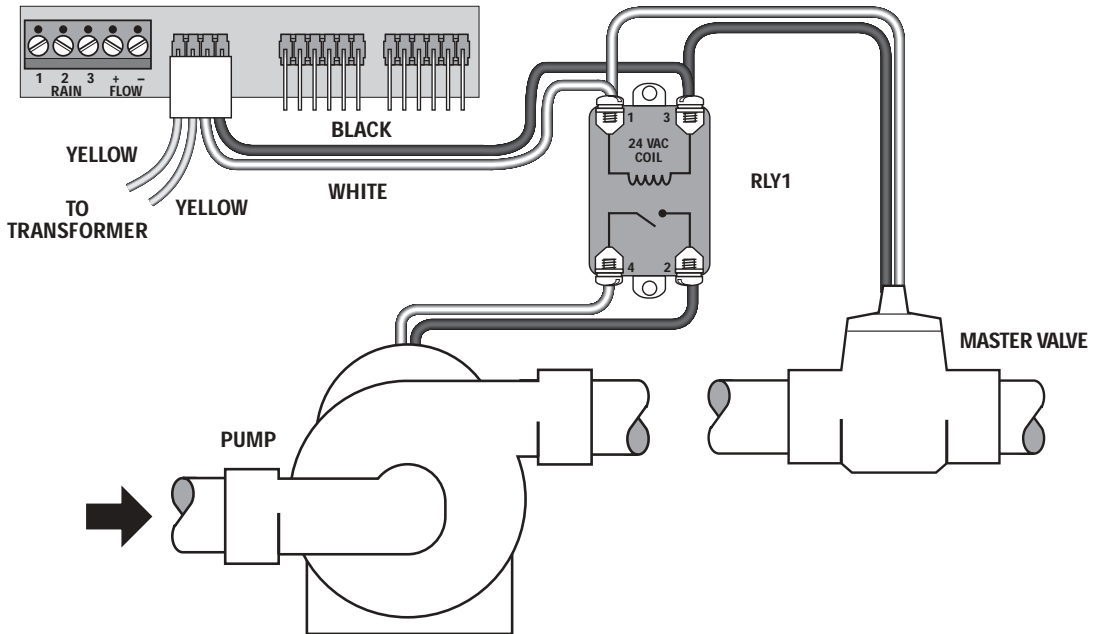

FIGURE 4. SIMULTANEOUS NORMALLY CLOSED MASTER VALVE AND PUMP CONNECTION WITH ISOLATION RELAY

### Independent Normally Closed Master Valve and Pump Operation

If you have a Master Valve which requires activation to open, and a pump which is sometimes needed when irrigating, connect the Master Valve Solenoid to the MV and Valve Common terminals and the pump starter to Station 1 as shown in Figure 5. If the pump starter DOES NOT operate on 24 VAC OR the combination of the Master Valve Solenoid and pump starter require more than 1 Amp, you will need an isolation relay (Rain Master part: RLY1 or equivalent) as shown. During SETUP, select the NC (Normally Closed) Valve type for all programs which require the Master Valve and select Pump Operation for all programs which require it.

If more than one clock is going to control the Master Valve or pump, the clocks must be isolated from each other. Contact RMIS for the pamphlet on multiple clock installations.

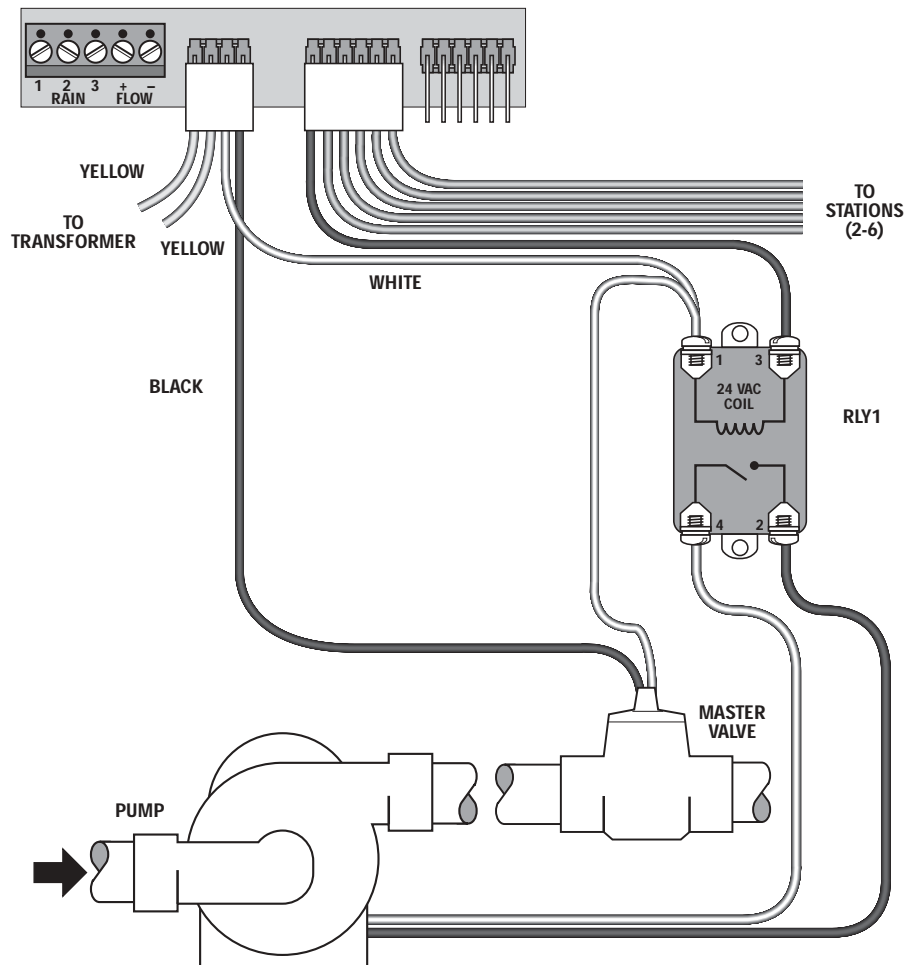

FIGURE 5. INDEPENDENT NORMALLY CLOSED MASTER VALVE AND/OR PUMP CONNECTION WITH ISOLATION RELAY

### Normally Open Master Valve

If you have a Master Valve which is always open until energized, connect the solenoid to the MV and Valve Common terminals as shown in Figure 2. During setup, select valve type NO (Normally Open). The Master Valve will only be activated when the controller detects a Main Line Break or Unscheduled Flow condition. In this case, a fault condition will exist until manually cleared.

### Normally Open Master Valve and Pump Operation

If you have a Master Valve which is always open until energized and a pump, connect the solenoid to the MV and Valve Common terminals and the Pump to Station 1 as shown in Figure 5. During setup, select valve type NO (Normally Open). The Master Valve will only be activated when the controller detects a Main Line Break or Unscheduled Flow condition. In this case, a fault condition will exist until manually cleared. Also during SETUP, assign which programs (1-4) require the pump to operate.

### FLOW SENSOR INSTALLATION

Refer to Figure 6. Install the Flow Sensor in the Main Line as shown, making sure that there are at least 10 pipe diameters upstream and 5 pipe diameters downstream of the sensor from any valve, reducer, elbow, or other obstruction or device which may cause turbulence in the water flow. Observe the proper direction of flow according to the flow arrow on the sensor. Install a valve box around the sensor and make the electrical connections inside the box. Use waterproof nuts over the splices.

The use of Rain Master EV-CAB-SEN or other shielded cable is required to ensure proper operation. Polarity must be observed when connecting the sensor to the controller.

#### EXAMPLE: FOR 3" FLOW SENSOR, DIMENSION 'A' MINIMUM 30" DIMENSION 'B' MINIMUM 15"

Upon completion of the physical installation of the flow sensor, complete the wiring connection from the flow sensor to the HAWK controller by following the procedure below.

1. **TURN THE POWER OFF AT THE CONTROLLER**
2. At the Flow Sensor:
  - Connect the **BLACK** wire of the Flow Sensor to the **BLACK** wire of the "EV-CAB-SEN", sensor cable.
  - Connect the **WHITE** wire of the Flow Sensor to the **WHITE** wire of the "EV-CAB-SEN", sensor cable.

\*Use the weatherproof connectors provided with the Flow Sensor to make the splice.
3. At the controller:
  - Connect **BLACK** wire of "EV-CAB-SEN" to "FLOW-" of the HAWK
  - Connect **WHITE** wire of "EV-CAB-SEN" to "FLOW+" of the HAWK
4. Turn **POWER ON** at the Controller.
5. Set the pipe size for the Flow Sensor at the controller based on the type and size of the Flow Sensor installed.

**FIGURE 6. TYPICAL CONNECTIONS FOR FLOW SENSOR**

## SENSOR WIRING

Most sensors, either Rain or Moisture type, are generally 2 or 3 wire. The 2 wire sensors are connected to terminal 1 and 2 on the sensor terminal block (See Figure 7)

Most 3 wire sensors will work if connected as follows: (See Figure 7)

Common wire to terminal #2

Valve common connects to terminal #1

24 VAC wire connects to terminal #3

Please check sensor wiring instructions for further details.

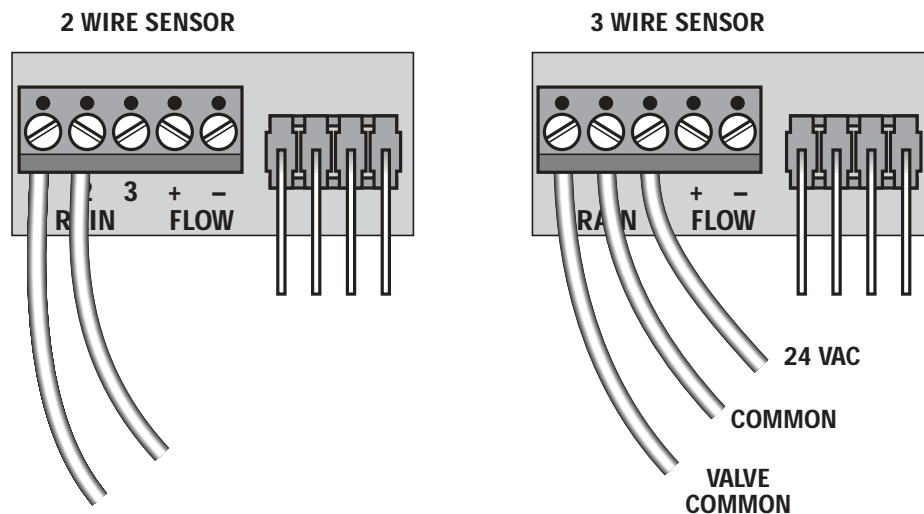

FIGURE 7. SENSOR WIRING

## TAPPING WIRES TO LOCATE VALVES IN THE FIELD

**DON'T** – Do not turn a station on and tap a wire to the controller's station terminal/wire to see what valve in the field is connected to it. This is damaging to both mechanical and solid state controllers and will cause the controller to go into a fieldwire fault detection mode. The simple method shown below is safe and will work for both types of controllers.

1. Use Manual Station to turn on Station 1, perhaps for 1 hour.
2. Flip the Rain Switch to the “No Watering” position.
3. Touch the wire from the unknown field valve to the controller's Station 1 terminal/wire.
4. Flip the Rain Switch to the “Automatic Watering” position and the valve on that wire will be activated.
5. When you know what valve it is, flip the Rain Switch off before removing the field wire from the controller's station terminal/wire.
6. Choose the next field wire and start the process over at Step 2.
7. When all done, turn off Station 1.

## REMOTE CONTROL CAPABILITY



All Rain Master controllers feature patented built-in remote control capability which allows you to operate the controller for a distance of 1 mile in congested areas via a hand held transmitter. (Consult the Remote Manual for operating instructions). Never connect anything but a Rain Master remote control receiver to the controller's front panel remote control connector or damage will result. Connecting to any other remote control device to any portion of the Rain Master controller will void all warranties and may cause damage.

## ELECTRICAL SPECIFICATIONS

Input power required: 105-130 VAC, 50/60 Hz, .5 amp maximum, .1 Amp idle

Output power: 24 VAC, 1.5 Amps maximum total output or 36 VA maximum total output 1 Amp per station of Master Valve

Solenoids are rated in either Amps or VA. The term VA stands for Volt-Amps, which is obtained by multiplying the Amps required by the operating voltage, 24 VAC.

Most modern solenoids require approximately .25 Amps, which is equivalent to 6 VA. This means that up to six solenoids can be energized at the same time. If you are using a Master Valve and separate pump, for example, you may use the NO STACK option in SETUP and run all four programs simultaneously.

Example:

Four programs	(.25 A times 4)	1.00 Amps
Master Valve	(.25 A times 1)	.25 Amps
Pump using Rain Master RLY1	(.20 Amps)	.20 Amps
<hr/>		
Total Current		1.45 Amps

This does not exceed the maximum allowable 1.5 Amp controller limit.

If higher current solenoids are used or if more than one solenoid is connected to one station output, caution should be used when operating in NO STACK mode.

**THIS PAGE INTENTIONALLY LEFT BLANK.**

## **KEY OPERATIONS**

There are three types of keys on the face of the controller. The diagram below shows the location of each group of keys. A detailed explanation of each key is given on following pages.

## FUNCTION KEYS

These keys (tan color) perform a specific function.

### SETUP

Allows you to perform the following setups:

- Program a Master Valve to any or all programs.
- Program the type of Master Valve to be either a Normally Closed Master Valve or a Normally Open Master Valve.
- Program a Pump to any or all programs.
- Program stacking or non-stacking of programs
- Program time delay between station(s) from 0 – 255 seconds (4 mins. 15 secs.)
- Program a security code
- Program a sensor to any or all programs
- Program audible alarm warning
- Program any or all programs to be either a cycle and soak program or not.
- Program the flow sensor features to be enabled or not.
- Program the pipe size for the flow sensor to be either 1, 1.25, 1.5, 2, 3 or 4 inches.
- Program the main line flow limit, which is the maximum flow when the controller is watering, to be from 01 to 999 GPM.
- Program the unscheduled flow limit, which is the maximum flow when the controller is not watering, to be from 0 to 999 GPM.
- Program the flow check delay, which is the amount of time the controller waits after any station changes before any flow limits are checked, to be from 1 minute to 6 minutes.
- Clear the total accumulated gallons and look at the total accumulated gallons.
- Program the flow percentage, which is a percentage that will be used to adjust all station flow limits, to be from 5% to 80%.
- Program a station flow limit for each station, from 0 to 500 GPM, either by explicitly setting a limit for each station or by running a watering profile during which the controller will LEARN each station's upper flow limit.

### SET TIME

Allows you to set the current time and day in the controller.

### PROGRA M

Allows you to select the program that is required (from 1 - 4).

### WATER DAYS

Is used to select the water days that the program is to operate on.

**STATIONS**

Is used to select the stations and runtimes in each program. If the program is specified to be a cycle and soak one, via Setup, then it is also used to set the maximum time and soak time for each station.

**START  
TIMES**

Is used to select the start time(s) for each program. (up to 5 per program).

**QUICK  
STATIONS**

Is used when a block of stations with the same runtime is being programmed. If the program is specified to be a cycle and soak one, via Setup, then it is used to program a block of stations with the same runtime, maximum time and soak time.

**WATER  
%**

Is used to allow you to change the runtimes (from 0% to 300%) for each station on a percentage basis by program

**REVIEW**

Is used to review all the information on each program in the controller. Is also used to look at the total gallons used.

**MANUAL**

Is used to allow you to turn on a program, station, or check all stations. Additional uses include locking and unlocking the controller once a security access code has been entered via SETUP, and advancing to the next station when executing a program.

**SKIP DAYS**

Is used when you wish to use the Skip By Day method.

**EXECUTE KEYS**

These keys will execute the function that has been selected to be programmed.

**ENTER**

**All DATA KEY input (see below) must be followed by the ENTER key to be accepted by the controller.**

**CLEAR**

Allows you to clear a selected function out of a program. This key will also put the controller in the programmable rain mode.

**QUIT**

Is used on completion of a function after it has been executed and will return the controller to the automatic mode. **This key may be pressed to exit any function.**

## DATA KEYS

These keys are used to select days of the week when entering time and day, and are used to select numbers such as runtimes, delay times etc.

**The number 1 key is also a toggle ON/OFF key when used in the Setup mode.**

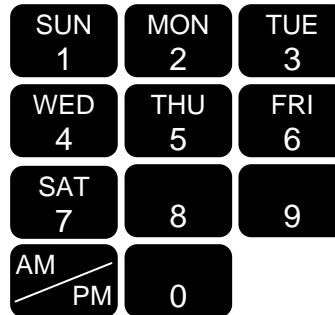

## WORDS AND TERMS USED IN THE DISPLAY

HELLO  
PROGRAM

- = Hello will be displayed when the controller is powered up for the very first time.  
When Hello is displayed there are NO user programs in the controller. If left in the HELLO mode the controller will begin to water every station for 10 minutes, starting 6 hours after the HELLO has been displayed. The 10 minute per station watering shall repeat every 24 hours

**Hitting any key exits HELLO mode, and removes the default watering program.**

### UNDER SETUP

MV  
PROGRAM

- = Master Valve

TYPE-NC  
PROGRAM

- = Master Valve type is normally closed (NC)

TYPE-NO  
PROGRAM

- = Master Valve type is normally open (NO)

PUMP  
PROGRAM

- = Pump

STACK  
PROGRAM

- = Ensures that programs run one after another, even if their start times overlap.

NO STACK  
PROGRAM

- = Run programs at their scheduled start times. In the event that start times overlap, multiple programs will run concurrently

DELAY000  
PROGRAM

- = Time delay between stations (in seconds)

CODE0000  
PROGRAM

- = Access or Security Code

SNSR  
PROGRAM

- = Sensor input

ALARM ON/ OFF	= An audible beep will be given off (or not) if a fault is detected.
PROGRAM	
SOAK	= Cycle and Soak.
PROGRAM	
FLOW ON/OFF	= Flow sensor features are enabled (or disabled)
PROGRAM	
PIPE 100	= Flow sensor is standard 1" pipe
PROGRAM	
PIPE 125	= Flow sensor is standard 1.25" pipe
PROGRAM	
PIPE 150	= Flow sensor is standard 1.5" pipe
PROGRAM	
PIPE 200	= Flow sensor is standard 2" pipe
PROGRAM	
PIPE 300	= Flow sensor is standard 3" pipe
PROGRAM	
PIPE 400	= Flow sensor is standard 4" pipe
PROGRAM	
PIPEOTHR	= Reserved for Rain Master use only.
PROGRAM	
MAIN 500	= Main line flow limit (in GPM)
PROGRAM	
UNSCH200	= Unscheduled flow limit (in GPM)
PROGRAM	
FDELAY2	= Flow check delay (in minutes)
PROGRAM	
TOTAL...GALLON S...	= The total gallons used since the last time it was cleared. (display flashes "TOTAL", "GALLONS", then number.)
PROGRAM	
PERCNT20	= Percentage adjust to all station upper flow limits
PROGRAM	



LIMITS

PROGRAM

= Upper flow limits for stations

100 GPM

PROGRAM

= **This display appears in three different instances (if flow sensing has been enabled).**

1. Flashes when an automatic program is executing.
2. In Manual System Check/Syringe Cycle.
3. Displays measured flow while the controller is going through watering profile to LEARN station upper flow limits.

1 - 200

PROGRAM

= Upper flow limit for a station in GPM (example shows station 1 upper flow limit of 200 GPM)

123 200

PROGRAM

= Measured flow (on left) and upper flow limit for the station (on right)

## OTHER TERMS

LOCKED

PROGRAM

= A security code has been entered and enabled. Requires reentry of the access code to unlock.

LO -

PROGRAM

= Low, used in quick stations function

HI -

PROGRAM

= High, used in quick stations functions

1

PROGRAM

= Inhibited, used with the rain switch

LN

PROGRAM

= Length, used in station function and in quick station function

RUNTIM

PROGRAM

= Momentarily comes up before the runtime is to be entered in the station feature and quick station feature, if the program is Cycle and Soak.

<div style="background-color: black; color: white; padding: 2px 10px; border-radius: 5px; display: inline-block;">MAXTIM</div> PROGRAM	= Momentarily comes up before the maximum time is to be entered in the station feature and quick station feature, if the program is Cycle and Soak.
<div style="background-color: black; color: white; padding: 2px 10px; border-radius: 5px; display: inline-block;">SOAKTI</div> PROGRAM	= Momentarily comes up before the soak time is to be entered in the station feature and quick station feature, if the program is Cycle and Soak.
<div style="background-color: black; color: white; padding: 2px 10px; border-radius: 5px; display: inline-block;">LFT</div> PROGRAM	= Left, used in skip days function
<div style="background-color: black; color: white; padding: 2px 10px; border-radius: 5px; display: inline-block;">NO</div> PROGRAM	= No, used anytime to indicate invalid info.
<div style="background-color: black; color: white; padding: 2px 10px; border-radius: 5px; display: inline-block;">OFF</div> PROGRAM	= Off, indicates the controller is off and will not water
<div style="background-color: black; color: white; padding: 2px 10px; border-radius: 5px; display: inline-block;">OK</div> PROGRAM	= Okay, indicates an acceptance of an option
<div style="background-color: black; color: white; padding: 2px 10px; border-radius: 5px; display: inline-block;">P O R S</div> PROGRAM	= Program (P) or station (S) used in manual function
<div style="background-color: black; color: white; padding: 2px 10px; border-radius: 5px; display: inline-block;">PROG</div> PROGRAM	= Program, used in program function
<div style="background-color: black; color: white; padding: 2px 10px; border-radius: 5px; display: inline-block;">PT-</div> PROGRAM	= Percentage, used in percentage function
<div style="background-color: black; color: white; padding: 2px 10px; border-radius: 5px; display: inline-block;">SD-</div> PROGRAM	= Skip days, (SD) used in the skip days function
<div style="background-color: black; color: white; padding: 2px 10px; border-radius: 5px; display: inline-block;">SET TIME</div> PROGRAM	= Set time, used in the set time function
<div style="background-color: black; color: white; padding: 2px 10px; border-radius: 5px; display: inline-block;">STATION</div> PROGRAM	= Station, used in the stations function
<div style="background-color: black; color: white; padding: 2px 10px; border-radius: 5px; display: inline-block;">STATIONS</div> PROGRAM	= Stations, used in the review feature
<div style="background-color: black; color: white; padding: 2px 10px; border-radius: 5px; display: inline-block;">WOAY</div> PROGRAM	= Water days, used in the water days function

<div style="background-color: black; color: white; padding: 2px; text-align: center; font-weight: bold;">RAIN - N</div> <div style="text-align: center; margin-top: 2px;">PROGRAM</div>	= The controller has been placed in the programmable rain mode and will not water for “N” days. “N” indicates the remaining days (1-7) before next water.
<div style="background-color: black; color: white; padding: 2px; text-align: center; font-weight: bold;">SNSR - WET</div> <div style="text-align: center; margin-top: 2px;">PROGRAM</div>	= The rain sensor associated with this program is in a wet condition, used in the review feature.
<div style="background-color: black; color: white; padding: 2px; text-align: center; font-weight: bold;">SNSR - DRY</div> <div style="text-align: center; margin-top: 2px;">PROGRAM</div>	= The rain sensor associated with this program is reading a dry condition.
<div style="background-color: black; color: white; padding: 2px; text-align: center; font-weight: bold;">*</div> <div style="text-align: center; margin-top: 2px;">PROGRAM</div>	= A program is running in the automatic mode but no stations are watering because the rain sensor is enabled and a wet condition exists.
<div style="background-color: black; color: white; padding: 2px; text-align: center; font-weight: bold;">CHECK</div> <div style="text-align: center; margin-top: 2px;">PROGRAM</div>	= In Manual System Check/Syringe Cycle and the flow sensor features are not enabled.
<div style="background-color: black; color: white; padding: 2px; text-align: center; font-weight: bold;">WAIT</div> <div style="text-align: center; margin-top: 2px;">PROGRAM</div>	= Flashes at about 1 second rate during power up (only if power up takes a long time; power up usually takes several seconds but under very unusual circumstances can take several minutes).
<div style="background-color: black; color: white; padding: 2px; text-align: center; font-weight: bold;">FAULT...PRES S...</div> <div style="text-align: center; margin-top: 2px;">PROGRAM</div>	= Either an overcurrent or short circuit has occurred on one or more stations, field wires or valve solenoids OR a flow limit violation has occurred. Press Review for more information.
<div style="background-color: black; color: white; padding: 2px; text-align: center; font-weight: bold;">WIRING</div> <div style="text-align: center; margin-top: 2px;">PROGRAM</div>	= Shown when REVIEW is pressed during a fault condition and the problem is an overcurrent or short circuit in the station field wiring. The faulty station(s) will be shown in the LED lights.
<div style="background-color: black; color: white; padding: 2px; text-align: center; font-weight: bold;">FLOW STA</div> <div style="text-align: center; margin-top: 2px;">PROGRAM</div>	= Shown when REVIEW is pressed during a fault condition and the problem is a station upper flow limit violation. The faulty station(s) will be shown in the LED lights. Subsequent press of the REVIEW key shows the measured flow in GPM at the time the fault was detected.



= Shown when REVIEW is pressed during a fault condition and the problem is an unscheduled flow limit violation. Subsequent press of the REVIEW key shows the measured flow in GPM at the time the fault was detected.



= Shown when REVIEW is pressed during a fault condition and the problem is a main line flow limit violation. Subsequent press of the REVIEW key shows the measured flow in GPM at the time the fault was detected.

## AUTOMATIC MODE

The controller is in the Automatic Mode whenever the time is displayed, and the day of the week indicator light is lit.

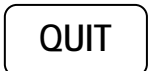
Pressing  will always return the controller to the automatic mode.

When a program is watering in the Automatic Mode, the station and program number will be displayed as a convenience. If the controller has been SETUP to enable flow sensing, the measured flow (GPM) will alternately appear in the display at a 1 second rate.

A \* in place of the program number indicates a program is running but all stations are off because the rain sensor is enabled and a wet condition exists.

To advance to the next station in a program when a program is already watering,

Press: 

To stop and cancel a program that is watering,

Press:  

The controller goes back to the Automatic Mode.

## RAIN MODE

The controller has a Rain Switch. The switch MUST BE in the "Auto Watering" position anytime watering is desired. In the "Auto Watering" position, watering WILL occur if the controller is programmed to do so.

The switch should be placed in the "No Watering" position when no watering is desired, such as when it is raining, etc. In the "No Watering" position, no watering will occur and the letter "I" will appear in the display to indicate that all programs are Inhibited from watering. The user's program will not be disturbed.

## PROGRAMMABLE RAIN

This method is used in place of the Rain Switch when you know how many days you want the controller to stay off. It allows you to select the number of days, from 1-7, that the controller will stay in the Rain Mode after which it will go back to the Automatic Mode by itself.

EXAMPLE: You wish the controller to stay off for 6 days.

Press:    The controller will display 

Each night at midnight the controller will deduct one day until it finally goes back to the Automatic Mode.

**Note:** *No watering will occur when it goes back to the Automatic Mode if you have also placed the Rain Switch in the “No Watering” position.*

**THIS PAGE INTENTIONALLY LEFT BLANK.**

## QUICK AND BASIC PROGRAMMING

Before the controller will operate, some basic information must be programmed.

1. Set the Time of day and Day of the week for the controller.
2. Establish a valid watering program:
  - a. Choose the program number you wish to work with (1-4).
  - b. Set the water days
  - c. Set the stations and the watering time for each station.
  - d. Set the start time(s) the program will begin to water on the chosen days.

### SET TIME

This is used to set the current time of day and the current day of the week.

EXAMPLE 1: The time is 2:00 PM, Sat.

Press: **SET TIME** **MON** **2** **0** **0** **AM** **ENTER** **SAT** **7** **ENTER**

The controller goes back to the Automatic Mode.

EXAMPLE 2: The time is 10:35 AM, Tue.

Press: **SET TIME** **SUN** **1** **0** **TUE** **3** **THU** **5** **ENTER** **TUE** **3** **ENTER**

The controller goes back to the Automatic Mode.

### PROGRAM

This is used to select the program(s) you wish to work with. Once selected, you need not change the Program # until you wish to program or review information in a different program. There are 4 programs available for your use. They are referred to as 1, 2, 3, and 4. If desired, it is also possible to select and clear ALL information in a program using this function.

### PROGRAM SELECTION

Select the program you wish to work with, either 1, 2, 3, or 4. While programming other functions, the selected program number is displayed as a convenience.

EXAMPLE: You wish to work with Program 2.

Press: **PROGRA** **M** **MON** **2** **ENTER**

The controller goes back to the Automatic Mode.

## PROGRAM CLEAR

If desired, it is possible to both select and clear all information in a program.

EXAMPLE: You wish to select and clear all information in Program 1.

Press: **PROGRA  
M** **SUN  
1** **CLEAR**

The controller goes back to the Automatic Mode

## WATERING DAY SELECTIONS

Watering days for Programs 1, 2, 3 and 4, may be set on a 7 day week OR a skip days mode. Although you cannot do both within the same program, each program may be set to either mode.

EXAMPLE: Program 1 may be on a 7 day weekly basis but Program 2 might be on a skip days basis.

## WATER DAYS

To select watering days based on a 7 day week. Watering will occur on the days selected each and every week. Selected days are shown in the top display. The Program # is shown in the display as a convenience.

EXAMPLE: You wish to water on Sunday, Wednesday and Friday.

Press: **WATER  
DAYS** **SUN  
1** **ENTER** **WED  
4** **ENTER** **FRI  
6** **ENTER** **QUIT**

The controller goes back to the Automatic Mode.

To remove a watering day, such as Sunday,

Press: **WATER  
DAYS** **SUN  
1** **CLEAR**

Press: **QUIT**

The controller goes back to the Automatic Mode

To review Water Days information,

Press: **WATER  
DAYS** (An LED light will light up for everyday that watering is to occur.)

Press: **QUIT**

The controller goes back to the Automatic Mode.



## SKIP DAYS

This is used to establish a number of days between watering, from 1 to 30, and how many days are left till the first watering will begin. If information has been entered in the past, the Skip Day number will be shown in the display. The Program # is shown in the display as a convenience.

*Note: 0 days left means the watering day is today.*

*Note: By using the skip days mode you can have a program water every 2nd, 3rd, 4th,... or 30th day as may be desired.*

EXAMPLE: You wish to skip 2 days and water every third day, and to start it 4 days from now.

Press:

The controller goes back to the automatic mode.

To clear all Skip Days information,

Press:

the controller goes back to the Automatic Mode.

To review Skip Days information

Press:

and the skip day number is shown,

Press:  (the number of days left before the next watering is shown.)

Press:

The controller goes back to the Automatic Mode.

## STATIONS AND WATERING TIMES

Any station may be placed in any program. Stations may be placed in more than one program at a time if desired. Within each program, each station can have a different runtime. Each program can individually be selected (via SETUP) to be either a conventional program or a cycle and soak program. Depending upon the selection, the RME HAWK will prompt for the appropriate information whenever the STATION key is pressed.

## STATIONS (for a conventional program)

This is used to select the stations and set the runtime for each station. After entering the desired Station #, the runtime for the station is then entered. Percentage is briefly shown at the beginning to remind you of its setting. Selected stations are shown in the top display. The Program # is shown in the display as a convenience.

EXAMPLE: You wish to set Station 1 for 10 mins., Station 2 for 10 mins, Station 6 for 1 hr. and 15 mins. and Station 7 for 8 mins.

Press: **STATIONS** **SUN 1** **ENTER** **SUN 1** **0** **ENTER**  
**MON 2** **ENTER** **SUN 1** **0** **ENTER**  
**FRI 6** **ENTER** **SUN 1** **SUN 1** **THU 5** **ENTER**  
**SAT 7** **ENTER** **8** **ENTER**

Press: **QUIT** The controller goes back to the Automatic Mode.

To clear a station and its runtime, such as Station 7,

Press: **STATIONS** **SAT 7** **CLEAR**

Press: **QUIT**

The controller goes back to the Automatic Mode.

To review selected Stations information

Press: **STATIONS** (An LED light will light up for every station that has a valid runtime).

Press: **QUIT**

The controller goes back to the Automatic Mode.

To review the runtime of a station, such as Station 6,

Press: **STATIONS** **FRI 6** **ENTER** (the runtime length is displayed)

Press: **ENTER** to leave the runtime as is and continue reviewing

Press: **QUIT**

The controller goes back to the Automatic Mode.

## QUICK STATIONS (for a conventional program)

This is used to rapidly program a block of stations which all have the same runtime. First the lowest station number is entered, then the highest and then the runtime. This length is applied to all the stations from the lowest through the highest. Selected stations are shown in the top display. Percentage is briefly shown at the beginning to remind you of its setting. The Program # is shown in the display as a convenience.

EXAMPLE: You wish to set all stations from 12 through 34 for 56 mins.

Press: **QUICK STATIONS** **SUN 1** **MON 2** **ENTER** **TUE 3** **WED 4** **ENTER** **THU 5** **FRID 6** **SAT 7**

The controller goes back to the Automatic Mode.

## CYCLE AND SOAK

A cycle and soak program can be used to eliminate runoff. Runoff occurs whenever the precipitation rate of the irrigation system exceeds the percolation rate of the soil. The Cycle and Soak program allows each individual station to be programmed to eliminate the wasteful effect thereby maximizing water savings. In a conventional program each station in the program will run for the full runtime and then the next station will run, etc.

**Note:** *To configure a program for Cycle and Soak operation, refer the SETUP Cycle and Soak on page 53.*

In a cycle and soak program, in addition to the runtime, there are two other times associated with each station: the maximum watering time and the soak time. The maximum watering time is the maximum time that the station can be on before runoff occurs. The soak time is the amount of time that the station must be off before it can come on again. This time allows the water to percolate into the root zone of the plant material. In a cycle and soak program the controller figures out a profile to run the stations that minimizes the total watering time for the program and intelligently schedules stations to run while other stations are satisfying their soak times. At the end of the profile each station will have run for its full runtime but the runtime may not be contiguous. For a particular profile, it may be that at times during the profile no stations will be on.

Cycle and Soak Station Parameters			
Parameter	Minimum	Maximum	Increment
Runtime	1 Min	9 Hrs 59 Min	1 Min
Max Watering Time	1 Min	4 Hours	1 Min
SoakTime	1 Min	4 Hours	1 Min

### STATIONS (for a cycle and soak program)

This is used to select the stations and set the runtime, the maximum watering time and the soak time for each station. After entering the desired station number, the runtime is entered followed by the maximum watering time, and finally the soak time. Percentage is briefly shown at the beginning to remind you of its setting. The percentage only applies to the runtime and not to the maximum watering time or soak time. Selected stations are shown at the top of the display. The program number is shown in the display as a convenience.

**Note:** *If a pump is assigned to any program (via Setup) then station 1 cannot be selected as it is reserved for the pump.*

EXAMPLE: You wish to set Station 1 for a runtime of 1 hr and 5 minutes, a maximum time of 35 minutes and a soak time of 45 minutes and station 6 for a runtime of 2 hrs, a maximum time of 1 hr and a soak time of 20 minutes. (You must have previously set, via Setup, the program for which you are entering information, to a cycle and soak program.)

Press: **STATIONS** **SUN**  
1 **ENTER** (controller will momentarily display "RUN TIME")

**SUN** **0** **THU** **ENTER** (controller will momentarily display "MAX TIME")  
1 5

**TUE** **ENTER** (controller will momentarily display "SOAK TIME")  
3

**WED** **THU** **ENTER**  
4 5

**FRI** **ENTER** (controller will momentarily display "RUN TIME")  
6

**MON** **0** **0** **ENTER** (controller will momentarily display "MAX TIME")  
2 0 0

**SUN** **0** **0** **ENTER** (controller will momentarily display "SOAK TIME")  
1 0 0

**MON** **0** **ENTER**  
2 0

Press: **QUIT**

The controller goes back to Automatic Mode

**Note:** *If the same station appears in multiple cycle and soak programs, only one value for the maximum time is allowed across programs. The same holds true for soak times.*

To clear a station and its runtime, such as Station 7,

Press:   

Press: 

The controller goes back to the Automatic Mode.

To review selected Stations information

Press:  (An LED light will light up for every station that has a valid runtime).

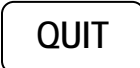
Press: 

The controller goes back to the Automatic Mode.

To review the runtime, maximum time and soak time of a station such as Station 6,

Press:    (the runtime is displayed)

Press:  to leave the runtime as is and continue reviewing

Press:  to leave the maximum time as is and continue reviewing

Press:  to leave the soak time as is and continue reviewing

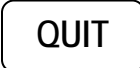
Press: 

The controller goes back to the Automatic Mode

### **QUICK STATIONS (for a cycle and soak program)**

This is used to rapidly program a block of stations which all have the same runtime, maximum watering time and soak time. First the lowest station number is entered and then the highest and then the runtime and then the maximum watering time and then the soak time. Percentage is briefly shown at the beginning to remind you of its setting. The percentage only applies to the runtime and not to the maximum watering time or soak time. Selected stations are shown at the top of the display. The program number is shown in the display as a convenience.

**Note:** *If a pump is assigned to any program (via Setup) then Station 1 cannot be selected as part of the block of stations as it is reserved for the pump.*

EXAMPLE: You wish to set all stations from 12 through 34 for a runtime of 1 hr and 56 mins and maximum time of 20 mins and a soak time of 15 mins. (You must have previously set, via Setup, the program for which you are entering information, to a cycle and soak program.)

Press: **QUICK STATIONS** **SUN 1** **MON 2** **ENTER** **TUE 3** **WED 4** **ENTER**

(controller will momentarily display “RUN TIME”)

**SUN 1** **THU 5** **FRI 6** **ENTER** (controller will momentarily display “MAX TIME”)

**MON 2** **0** **ENTER** (controller will momentarily display “SOAK TIME”)

**SUN 1** **THU 5** **ENTER**

The controller goes back to Automatic Mode

**Note:** *The maximum time and/or soak time entered will be used for the stations in the block for all cycle and soak programs and not just for the one being entered.*

## PERCENTAGE

The Percentage function provides for simple water budgeting by providing an easy method of increasing/decreasing the runtimes of ALL stations in a program with one simple entry. It is particularly useful during abnormally dry/hot/cold or wet periods.

The Percentage is set to 100 in all four programs by default, therefore, unless changed, each station in a program will run for 100% of its programmed time. Percentage may be set from 0 to 300%, in increments as small as 1%, for Programs 1, 2, 3 and 4 independently.

For instance, setting the Percentage in a program to 161 will make the runtime of each station 1.61 times its programmed runtime. Setting the Percentage to 70 will make the runtime 0.70 times its programmed runtime.

**Note:** *Even if Percentage is set to other than 100, the watering lengths of all stations in a program will not be changed when you view them. At all times, the length shown is the originally programmed length corresponding to 100%. However, the run time will be modified when the station waters.*



**Note:** *For a cycle and soak program the Percentage only applies to the runtimes and not to the maximum watering times or soak times.*

EXAMPLE: You wish to set a Percentage of 110 which will increase the watering times of all stations in a program by 10%.

Press:     

The controller goes back to the Automatic Mode.

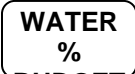
To clear Percentage

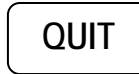
Press:   

The Percentage is reset to 100 and the controller goes back to the Automatic Mode.

To review Percentage

Press: 

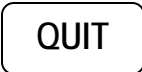
Press: 

The controller goes back to the Automatic Mode.

**Note:** *Percent calculations which result in fractional portions of minutes will irrigate for the precise time. For example, assume a 5 minute runtime with a percentage of 50%. This station will irrigate for 2 minutes and 30 seconds.*

## START TIMES AND AUTOMATIC PROGRAM OVERLAP PROTECTION

There are five start times available for each of Programs 1, 2, 3 and 4. They are referred to as Start Time 1 – Start Time 5.

Additionally, the controller allows you to select (via Setup) whether programs will be allowed to run one at a time (Stack) or run concurrently (No Stack) in the event that start times overlap with one another. Using Stack operation the controller ensures that only one program (e.g. one station) is allowed to be turned on at one time regardless of conflicting start times. The controller program(s) will wait for completion of the currently executing program before it will start the next program. The following examples describe STACK Operations:

EXAMPLE 1: If Program 1 is one hour long, due to the stations and watering times placed in it, and you set three of its start times to 7:00 AM, the program will water three times - from 7:00 to 8:00, 8:00 to 9:00 and 9:00 to 10:00 thereby providing two repeat cycles.

EXAMPLE 2: If Program 1 was again one hour long and was set to start at 7:00 AM Mon., and Program 3 was set to start at 7:30 AM on Mon. and Tue., then on Mon. Program 3 would begin at 8:00 AM, when Program 1 ended, but on Tue it would begin at 7:30 AM.

The Stack operation ensures that you will always get the number of watering cycles you desire and at the same time your system will never be under-pressurized because two programs are running simultaneously.

**Note:** *The controller is shipped with Stack active, however, it may be programmed so that multiple programs can be run simultaneously. See SETUP.*

## START TIMES

This is used to set the start time for a program. The Program # is shown in the display as a convenience.

EXAMPLE: You wish the program to start watering at 7:10 AM and 4:30 PM

Press: **START TIMES** **SAT** **SUN** **0** **ENTER** (The controller goes to Start Time 2.)  
**WED** **TUE** **0** **AM** **ENTER** (The controller goes to Start Time 3.)  
**4** **3** **PM**

Press: **QUIT**

The controller goes back to the Automatic Mode.

To review Start Times

Press: **START TIMES** (Start Time 1 is displayed).

To review Start Time 2

Press: **ENTER**

Press: **QUIT**

The clock goes back to the Automatic Mode.

To clear a start time, such as Start Time 2

Press: **START TIMES** (Start Time 1 is displayed).

To get to Start Time 2

Press: **ENTER** (Start Time 2 is displayed.)

To clear it

Press: **CLEAR** **QUIT**

The clock goes back to the Automatic Mode.



## REVIEWING PROGRAMS AND TOTALIZER

A unique feature of the HAWK controller is its REVIEW feature. At the push of a key, all program information will be displayed. Successive pushes of the REVIEW key cause the information to advance. Another way of reviewing information is to press and hold the Review key. As the key is held the information will automatically advance at a readable rate. Removing your finger causes the scrolling information to stop. Pressing QUIT at any time will return the controller to the Automatic Mode.

The information for the programs will start with information for the program selected (via the PROGRAM function key) and continue until Program 4. For instance if Program 1 is the selected program then information in Program 1 will be displayed first, followed by Program 2,3 and 4 and if Program 3 is the selected program then information in Program 3 will be displayed first, followed by Program 4.

The information presented is as follows:

1. If the flow feature was enabled (via SETUP), and Program 1 was the last selected program, then TOTAL...GALLONS... will be displayed

**Note:** *When using the REVIEW function, the total gallons screen records and updates measured gallons every 10 seconds. It can be used to check for unscheduled flow.*

2. If the Rain Sensor has been Enabled via Setup for this program then: SNSR-WET or SNSR-DRY will be displayed.
3. Start Times 1, 2, 3, 4 and 5 (displayed as Start Times).
4. Water Days (displayed as W DAY)
5. Skip Days (displayed as SD) and the number of days left until the next watering (displayed as LFT)
6. Percentage (displayed as PT)
7. Stations and their runtimes (displayed as STATIONS). If the program is a cycle and soak program (as selected via Setup), the maximum watering time and soak time will also be displayed for each station.

**Note:** *The runtime shown for each station is the programmed length and will not be changed by the value you may have set for the percentage adjust function.*

8. The total watering time for the program (displayed with H [hours] and M [minutes]). This is the actual watering time and takes into account all factors including the percentage adjust, any delay between stations (set via Setup) and any adjustments needed because the program is a Cycle and Soak program. The displayed value is rounded up; for instance a total time of 2 hours, 12 minutes and 14 seconds will be 2 hours and 13 minutes.

Press: **QUIT**

The controller goes back to the Automatic Mode

EXAMPLE: You wish to review program 3 only

Press: **PROGRA  
M** **TUE  
3** **ENTER**

Press: **REVIEW**

Press: **QUIT**

The controller goes back to the Automatic mode.





## MANUALLY ACTIVATED FUNCTIONS WITH EXAMPLES

The Manual Mode offers four different features shown below:

### MANUAL PROGRAM

This is used to run a program - assuming stations are in the program.

EXAMPLE: You wish to run Program 1.

Press:     (The display shows a 1 to indicate Program 1 is running. The active stations are also displayed.)

The controller goes back to the Automatic Mode.

To advance to the next station when the program is already watering:

Press: 

To stop the watering program that is currently running:

Press:  

The controller goes back to the Automatic Mode.

### MANUAL STATION

This is used to run a selected station for a selected time.

EXAMPLE: You wish to water station 6 for 25 min.

Press:       

(The display shows station and watering time. As time elapses, watering time will count down. When time ends, the station shuts off. The controller goes back to the Automatic Mode.)

To stop the watering station

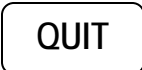
Press: 

The controller goes back to the Automatic Mode.

**Note:** *If a pump is assigned to any program (via Setup) then Station 1 is reserved for the pump, but it can still be turned on manually by specifying Station 1.*

**Note:** *If the Master Valve type is Normally Closed (as specified via Setup) then the Master Valve will come on with the station. If the station being turned on is in any program that has a*

*pump assigned to it (via SETUP) then the pump (Station 1 output) will come on with the station.*

## MANUAL MASTER VALVE

This is used to run only the Master Valve for a selected time. The MV is designated as Station 0.

EXAMPLE: You wish to run master valve for 4 min.

Press:

To stop:

Press:

## MANUAL SYSTEM CHECK/SYRINGE CYCLE

As a convenience for "walk throughs" and service work, and to measure the flow rate on a station, the controller has a system check feature built in. This will run each station, from the first to the last, for a selectable time of 1 to 9 mins.

EXAMPLE: For a 3 min. System Check

Press:    **DO NOT PRESS ENTER**

If the flow features have been enabled (via Setup) then the display will show the current measured flow rate in GPM during the CHECK mode. If the flow features are not enabled then CHECK will appear in the display.

To advance one station at a time:

Press:

To stop this cycle,

Press:

The controller goes back to the Automatic Mode.

**Caution: This mode sequentially runs every station in the controller. For example you have a 24 station unit but only use 23 stations, it will still apply power for Station 24 and while doing so will apply power to the Master Valve/Pump terminal.**

This could be a problem for a system when you are using the Master Valve output to drive a pump because during the period that Station 24 is activated, the pump will be pumping against a closed system. If the system uses a master valve, it will be activated during the period that Station 24 is

active and this could cause heating of the master valve's solenoid (if the valve depends on water flow to cool it). Therefore, if all stations are not used, cancel the System Check/Syringe cycle after the last used station has watered.

## MONITORING STATION FLOW

There are three ways to observe the measured flow in gallons per minute (GPM):

1. The measured flow is automatically displayed when the controller is in the automatic mode and one or more programs are operating.
2. When a manual system check is performed, the flow is shown for each station. Refer to MANUAL SYSTEM CHECK for details.
3. When in the SETUP function, measured flow can be observed on a per station basis when utilizing the LIMITS subfunction. Refer to the LIMITS setup feature in the ADVANCED SETUP PROGRAMMING section for more details.

## FAULT DETECTION OVERVIEW

The RME HAWK has the ability to detect and take corrective action for a number of field related failure conditions. The operator is informed of any fault condition when the display alternates with the following words:

FAULT..... PRESS ..... REVIEW

In addition to the display indication, the controller will chirp with an audible alarm once every six seconds signifying a fault occurrence.

**Note:** *The audible chirp may be disabled via the SETUP function.*

Pressing the REVIEW key reveals the specific fault type and momentarily suspends the audible chirp.

WIRING  
PROGRAM

= The problem is a field wiring short circuit on a station. The station lights illuminate to show which station(s) were faulty.

FLOW  
PROGRAM

= The problem is a main line flow limit violation. Pressing the REVIEW key again reveals the measured GPM at the time the fault occurred.

FLOW UN  
PROGRAM

= The problem is an unscheduled flow limit violation. Pressing the REVIEW key again reveals the measured GPM at the time the fault occurred.



= The problem is a station upper flow limit violation. The station lights illuminate to show which station(s) are involved. Pressing the REVIEW key again reveals the measured GPM at the time the fault occurred.

Whenever a specific fault is displayed it can be cleared by pressing the CLEAR key. Alternatively, if CLEAR is not hit, the QUIT key will return the controller back into the AUTOMATIC mode without clearing the fault condition.

Refer to the fault type(s) defined below for specific information.

## WIRING FAULT

The RME HAWK has been equipped to detect station short circuits which may occur due to improper field wiring or faulty valve solenoids. In the event a station draws excessive electrical current, the following action occurs:

- The offending station will be immediately turned off.
- The next scheduled station of the program will be started.
- FAULT...PRESS...REVIEW...appears in the display
- The controller will continue to execute programs, however, any faulted station(s) will not be turned on again.

**Note:** *If multiple stations are on simultaneously, and the controller detects an over current fault, all running stations will be diagnosed as faulty.*

**Note:** *If a short circuit occurs at the normally closed master valve and the program has been SETUP to use a master valve, the controller will successively condemn all remaining stations in the program. Upon reviewing the fault, all stations of the program shall illuminate, indicating that the problem appears at the master valve.*

### User Action:

1. Excessive station current may be due to an inadvertent direct connection between the station wire and the common wire
2. Check for exposed wiring in a flooded valve box
3. Check for a faulty valve solenoid.
4. When corrective action has completed, the fault should be cleared.

## FLOW MAIN FAULT

The main line flow limit for the controller has been exceeded.

- All present irrigation (running programs) are terminated.
- FAULT...PRESS...REVIEW...appears in the display
- If the master valve for the controller has been SETUP as a normally open (NO) master valve, then this terminal will be energized with 24 VAC (master valve is closed).

- All scheduled start times for future programs will be ignored (no programs will start)
- The controller remains in this state until the fault is cleared by you.

**User Action:**

1. Inspect the main line as well as major branches for failure.
2. Examine the main line limits to ensure they have been correctly established. If the controller has been SETUP for NO STACK operation, multiple stations may be on at the same time. The main line limit should be larger than the sum of the flow totals of all simultaneously "on" stations.
3. When corrective action has completed, the fault should be cleared.

**FLOW UNSCHEDULED FAULT**

The unscheduled flow limit has been exceeded. The controller tests for unscheduled flow whenever the controller is not performing any irrigation. With no irrigation, and a normally closed master valve, the typical installation should have no flow and the limit should be set to zero. For systems which have a normally open master valve and the possibility of supplemental watering due to quick coupler manual devices, you have the option of setting a non-zero value which shall be allowed when the controller does not have any active stations. If this value is exceeded the unscheduled flow fault occurs.

- All present irrigation (running programs) are terminated.
- FAULT...PRESS...REVIEW...appears in the display
- If the master valve for the controller has been SETUP as a normally open (NO) master valve, then this terminal shall be energized with 24 VAC (master valve is closed).
- All scheduled start times for future programs will be ignored (no programs will start)
- The controller remains in this state until the fault is cleared by you.

**User Action:**

1. The user should check for leaks, broken pipe(s), or physical damage.
2. Check the system for any stuck valves from a previous scheduled irrigation cycle.
3. Check that the unscheduled limit has been properly established. If quick coupling devices were on at the time the alarm occurred, ensure that there is enough margin for the unscheduled flow limit.
4. When corrective action has completed, the fault should be cleared.

## FLOW STATION FAULT

This fault occurs whenever the measured flow is more than the expected flow (upper station limit failure). Each time a station overflow condition is detected the following action occurs:

- The offending station will be immediately turned off.
- The next scheduled station of the program will be started.
- FAULT...PRESS...REVIEW...appears in the display
- The controller will continue to execute programs, however, any faulted station(s) will not be turned on again.

*Note: If multiple stations are on simultaneously, and the controller detects an overflow fault, all running stations will be diagnosed as faulty.*

### User Action:

1. Check for:
  - a. Stuck valve (from a previous station)
  - b. Broken pipes/heads
  - c. Incorrectly established individual station limits
  - d. Large variations in system water pressure
2. If station limits are suspected, proceed to the SETUP-LIMITS function to reestablish a stations nominal limit reading.
3. Compare the nominal reading and ensure that adequate margin exists (typical: 20% over nominal.)
4. When corrective action has completed, the fault should be cleared by you.



## ADVANCED SETUP PROGRAMMING

In addition to the many operating features available in your RME HAWK controller, there are a number of programmable features as well. (See User Programmable Features, page 4.)

### Setup Options and Controller Defaults

Function	Option	Default
Master Valve Used	Uses, Does Not Use	1,2,3,4 (all programs enabled)
Type of Master Valve	NC, NO	NC
Pump	Uses, Does Not Use	(all programs disabled)
Cycle and Soak	Uses, Does Not Use	(all programs disabled)
Flow Sensor Features	On, Off	Off
Pipe Size (inches)	1, 1.25, 1.5, 2, 3, 4	1.5 inches
Main Line Flow Limit	1-999 GPM	500 GPM
Unscheduled Flow Limit	0-999 GPM	200 GPM
Flow Check Delay	1-6 minutes	2 minutes
Total Gallons	N/A	N/A
Flow Percentage	5-80%	20%
Station Upper Flow Limits	0-500 GPM	200 GPM for all stations

By simply pushing the SETUP key, you can program the following functions. Successive pushing of the SETUP key will allow you to advance to the next setup feature.

Some of the SETUP functions will be skipped (on successive pushing of the SETUP key) depending on what you have entered for other previous SETUP functions. The conditions for which a SETUP function will be skipped are noted below in the description of the applicable SETUP function.

**IMPORTANT:** *When entering SETUP information the display will change but the controller will not actually accept the information until Enter or Clear (for those SETUP functions that accept Clear) is hit.*

## MASTER VALVE (MV)

Using this feature allows you to program a master valve to be activated when program 1,2,3 or 4 is activated. If you have your pump connected to the master valve output of the controller then use this feature to activate the pump when program 1,2,3 or 4 is activated.

EXAMPLE: You want a pump to go on when Programs 1 and 3 are running.

Press: **SETUP** you will see **MV 1 2 3 4**  
PROGRAM

Press: **MON 2** **WED 4** removes Programs 2 and 4 from having the Master Valve activated when these two programs come on.

you will see **MV 1 3**  
PROGRAM

Press: **ENTER**

Subsequent pressing of 2 and 4 will add the Master Valve back into Programs 2 and 4.

**Note:** *The Master Valve will not be activated with the program if it is a Normally Open type as selected in the next Setup option).*

## TYPE OF MASTER VALVE

This feature allows you to select either a normally closed or normally open master valve. A normally closed master valve is the most common type used in irrigation. If a normally open Master Valve is selected then it will not come on with any program but will come on when the controller detects a main line or unscheduled overflow condition.

**Note:** *This Setup function will be skipped if you have not selected a Master Valve for at least one program (in the MASTER VALVE Setup function). In this case the controller will act as if you had selected a Normally Closed Master Valve: therefore if you are using a normally open Master Valve select the Master Valve for at least one program. Refer to wiring diagrams and explanations in the MOUNTING & INSTALLATION section on page 7 before configuring this option.*

To select a normally open Master Valve:

Successively Press: **SETUP** until you see **TYPE-NC**  
PROGRAM

Press: **SUN 1** (remember this is a toggle key when used in the SETUP mode) until you see **TYPE-NO**  
PROGRAM

Press: **ENTER** **QUIT**

## PUMP



Using this feature will allow you to program a Pump to be activated when program 1,2,3, or 4 is activated. The controller uses Station 1 as the pump output. This feature should only be used for the Pump, if it is connected to the Station 1 output of the controller. If the pump is connected to the Master Valve output, then use the MV feature.

**Note:** *Refer to wiring diagrams and explanations in the MASTER VALVE and PUMP WIRING OPTIONS Section on page 9 before configuring this option.*

A typical example for usage of this feature occurs when using a normally open master valve and pump.

**Note:** *If you select a Pump for any program, the controller will not allow you to include a Station 1 runtime in any program. If you have already programmed Station 1 into a program the controller will automatically remove it.*

EXAMPLE: You want the Pump to go on when Programs 2 and 4 are running

Successively Press:  until you see   
PROGRAM

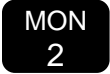
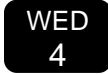
Press:   adds Programs 2 and 4 to having the Pump activated when these two programs come on.

you will see   
PROGRAM

Press:  Subsequent pressing of 2 and 4 will remove the Pump from Programs 2 and 4.

## STACK OR NO STACK

This feature allows you to run your programs one after another (Stack) or at the same time (No Stack). Where volume of water and pressure will allow, you have the option of running several stations from different programs at the same time.

**Note:** *The maximum current draw cannot exceed 1 amp per station, and 1.5 amps for the controller.*

EXAMPLE: You have a 30 station controller, and watering must be completed by 7:00 AM and cannot begin until 2:00 AM (5 hours total).

You can put:

- Station 1 through 7 in Program #1
- Station 8 through 14 in Program #2
- Station 15 through 21 in Program #3
- Station 22 through 30 in Program #4

Now set up your runtimes for each station, and the start time of 2:00 AM You must be sure not to have any program go over the 5 hours total runtime (check in review mode). You must also ensure your system can supply the volume of water required to supply 4 stations at one time.

To activate No Stack feature:

Successively Press: **SETUP** until you see **STACK**  
PROGRAM

Press: **SUN 1** (remember this is a toggle key when used in the Setup mode)  
 until you see **NO STACK**  
PROGRAM

Press: **ENTER** **QUIT**

## DELAY

This feature allows you to program a delay time between stations. A programmable delay can be useful to allow stations to reach a steady state condition before energizing the next station.

EXAMPLE: You want to have a 68 second delay time between stations being turned on

Successively Press: **SETUP** until you see **DELAY000**  
PROGRAM

Press: **FRI 6** **8** **ENTER** you will see **DELAY068**  
PROGRAM

Press: **QUIT**

*Note: Screen will read seconds only up to 255 seconds.*

## SECURITY CODE

*Note: This feature should only be used where security is limited.*

The RME HAWK controller has the capability to enter a password code which must be entered before any function(s) can be executed. This code can be up to 4 numbers long. Use a number that can be easily remembered, and have it written down should you forget.

### Entering A New Security Code

EXAMPLE: You wish to enter the year you were born as a code 1960

Successively Press: **SETUP** until you see **CODE0000**  
PROGRAM

Press: **SUN 1** **9** **FRI 6** **0** **ENTER**

Press: 

**Note:** *0000 is not a valid security code. 0000 means that the security code feature is not activated*

### Enabling Security Code

Once you have completed operating or making changes to your controller you can enable the security code:

Press:   

The controller will go back to the Automatic Mode.

Should you forget to enable the security code, the code will automatically become enabled at midnight and no one will be allowed to operate the controller without first entering the security code.

### Disabling Security Code (LOCKED Controller)

Once the Security Code feature has been enabled, it will be necessary to enter the security code every time you wish to operate or change your controller.

To disable the security code used in the example above:

Press:       

### Eliminating Security Code

To eliminate the Security Code completely, first disable code as described above, then:

Press:  6 times you will see   
PROGRAM

Press:     

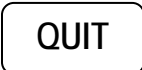
Press: 

## SENSOR

**Note:** *When this symbol \* appears in the beginning of the display screen, it indicates that the Sensor is reading "Wet", and one or more programs that are enabled for sensor operation have started. No stations, however, will water due to the wet condition.*

The RME HAWK Controller has the ability to affect irrigation based on an external rain sensor or remote switch. This feature can be programmed by individual program so that one or more programs will cease watering as long as the rain sensor is active.

The external sensor or switch must be of the type which is Closed when there is no rain detected, and opens when rain is detected or it is desired to suspend irrigation. Most commercial rain sensors are of this type. See the wiring instructions in the MOUNTING and INSTALLATION section.

EXAMPLE: You have program 4 set up to operate your outdoor lighting, however you also have a rain sensor connected to your RME HAWK.

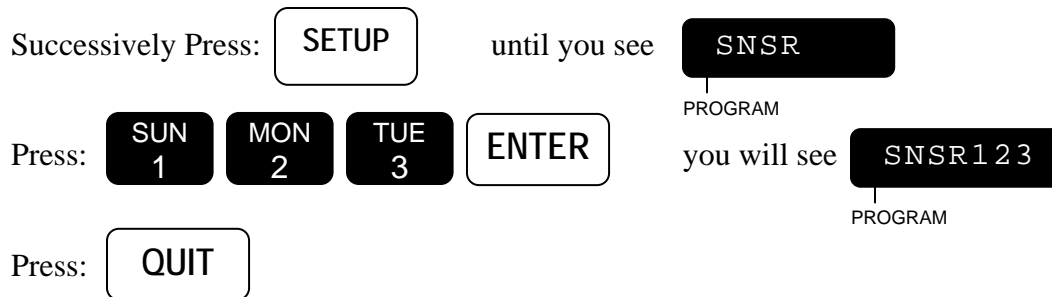

Once programmed in the above manner, the designated program(s) will not turn on any stations unless the rain sensor terminals labeled 1 & 2 are shorted together, either by an external switch or the appropriate rain sensor.

If any program is set up to be sensitive to the rain sensor then the status of the rain sensor can be determined by pressing the Review key repeatedly or holding it down until the display shows the word SNSR- followed by Wet or Dry. If Dry, the controlled program(s) will operate normally. If Wet, no irrigation will take place on those program(s). Additionally, when a program is scheduled to operate, an asterisk will appear in the leftmost location in the display IF the external sensor has detected rain, or the external switch is Open.

**Note:** *The external sensor is independent of the Rain Switch on the front of the controller. Leave the switch in the Automatic Watering position.*

To reinstate program 4 into the Sensor Mode:

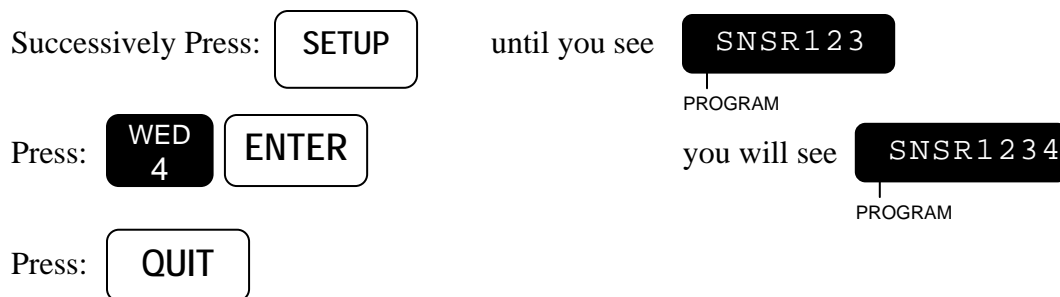

## ALARM

The RME HAWK controller is equipped with an audible alarm feature which notifies the operator if a field wire or flow fault has been detected. The alarm is an audible “chirp” which occurs once every 6 seconds. It remains in effect until the alarm is cleared by you. With the alarm on, the chirp will be heard by anyone passing by the controller.

To program this alarm: **SETUP**

Successively Press: until you see **ALARMOFF**  
PROGRAM

Press: **SUN 1** (Toggle Key) you will see **ALARMON**  
PROGRAM

Press: **ENTER** **QUIT**

### CYCLE AND SOAK

Using this feature allows you to select each program to be a cycle and soak program or not.

For a description of what a cycle and soak program means see the QUICK AND BASIC PROGRAMMING section of this manual under the heading of STATIONS AND WATERING TIMES.

EXAMPLE: You wish to make programs 1, 2 and 3 cycle and soak programs.

Successively Press: **SETUP** until you see **SOAK**  
PROGRAM

Press: **SUN 1** **MON 2** **TUE 3** **ENTER** you will see **SOAK 1 2 3**  
PROGRAM

Press: **QUIT**

### FLOW SENSOR FEATURES ENABLED/DISABLED

This Setup allows you to select the flow sensor features or not.

For a general description of how the flow features work, see the FAULT DETECTION OVERVIEW section of this manual.

**Note:** *All the rest of the Setups after this one are related to the Flow Sensor features and will be skipped if the Flow Sensor features are not enabled here.*

If you have a Flow Sensor connected to the controller and you wish to activate the Flow Sensor features:

Successively Press: **SETUP** until you see **FLOW OFF**  
PROGRAM

Press: **SUN 1** (remember this is a toggle key when used in the Setup mode) until you see **FLOW ON**  
PROGRAM

Press: **ENTER** **QUIT**

## PIPE

In order to properly measure flow, the pipe size of the Rain Master flow sensor must be specified. Appendix A lists flow sensor part numbers versus pipe size.

You can select the following pipe sizes in inches: 1, 1.25, 1.5, 2, 3 and 4.

Each depression of the 1 key will toggle the display to the next pipe size. (Selection of OTHR is reserved for future use.) When you have reached the pipe size you want to select, press ENTER.

**Note:** *This SETUP function will be skipped if you have not enabled the flow features.*

EXAMPLE: You wish to select a pipe size of 3 inches.

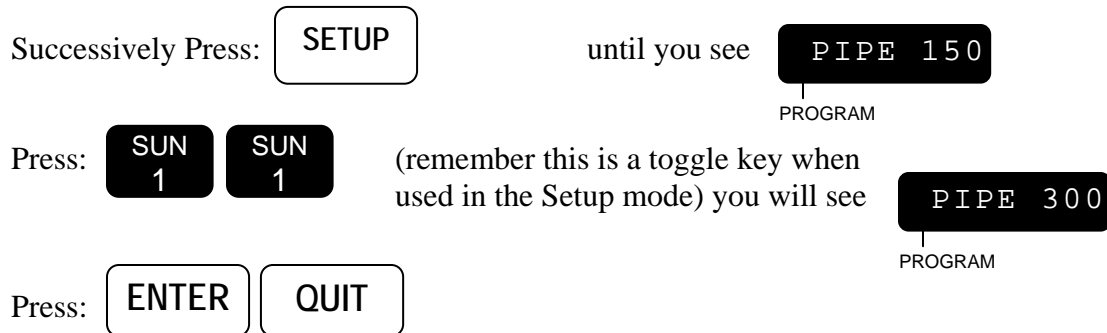

## MAIN LINE FLOW LIMIT

This feature allows you to program the main line upper flow limit. This is the maximum flow that the controller will allow whenever any station is on. If the controller has been SETUP for NO STACK operation, multiple stations may be on at the same time. The main line limit should be larger than the sum of the flow totals of all simultaneously "on" stations.

**Note:** *This SETUP function will be skipped if you have not enabled the flow features.*

EXAMPLE: You wish to select a Main Line Flow limit of 400 GPM.

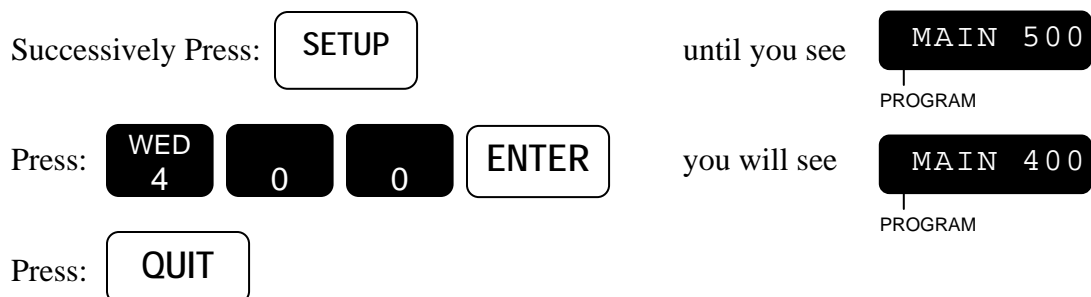

## UNSCHEDULED FLOW LIMIT

This feature allows you to program the unscheduled upper flow limit. This is the maximum flow that the controller will allow whenever no station is on. With no irrigation, and a normally closed master



valve, the typical installation should have no flow and the limit should be set to zero. For systems which have a normally open master valve and the possibility of supplemental watering due to quick coupler manual devices, you have the option of setting a non-zero value which shall be allowed when the controller does not have any active stations. If this value is exceeded the unscheduled flow fault occurs.

**Note:** *This SETUP function will be skipped if you have not enabled the flow features.*

EXAMPLE: You wish to select an Unscheduled Flow limit of 25 GPM.

Successively Press: **SETUP** until you see **UNSCH200**  
PROGRAM

Press: **MON 2** **THU 5** **ENTER** you will see **UNSCH025**  
PROGRAM

Press: **QUIT**

## FLOW CHECK DELAY

This feature allows you to program a delay after any change of stations for which no flow limits will be checked.

Whenever there is any change in which stations are on (any station gets turned on or off), the controller will not check for any flow limits from the time of the change until this delay has expired; this gives the system time to stabilize before any flow limit checking takes place.

The flow check delay can be set , from 1 to 6 minutes, in 1 minute increments.

**Note:** *This SETUP function will be skipped if you have not enabled the flow features.*

EXAMPLE: You wish to set the flow check delay to 4 minutes.

Successively Press: **SETUP** until you see **FOELAY 2**  
PROGRAM

Press: **WED 4** **ENTER** you will see **FOELAY 4**  
PROGRAM

Press: **QUIT**

## TOTALIZER

This feature allows you to view and clear the total gallons used. (The Totalizer value can also be viewed by using the REVIEW mode.)





The total gallons is the total since the last time you cleared it.

**Note:** *The total gallons will automatically be cleared when you select a new pipe size (via the Pipe Setup feature).*

**Note:** *This SETUP function will be skipped if you have not enabled the flow features .*



EXAMPLE: You wish to determine how many gallons you use in a month.

At the beginning of the month:

Successively Press:  until you see   
 Press:  you will see   
 Press:  PROGRAM

**Note:** *If you hit SETUP while the words TOTAL/GALLONS are on the display you will miss this Setup feature because the controller will go to the next Setup feature.*

Then at the end of the month:

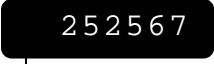
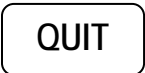
Successively Press:  until you see   
 followed by   
 Press:  PROGRAM  
 (this is your total gallons for the month)

**Note:** *The totalizer will reset to 0, after 9,999,999 gallons.*

### FLOW PERCENTAGE

This feature can be used to globally establish station flow upper limits. The flow percentage can be set from 5 to 80%. This feature can be used in two ways:

1. Assume limits need to be established for a new system and you wish to have all station flow limits to be 15% above their nominal value.

Then

- Set the flow percentage to 15%.
- Run Automatic LIMITS (see next section) for all stations.
- The new limits will be automatically saved (nominal measured flow + 15%) for each station.

- Your system has been operational for some time. Occasionally, one or more stations seemingly at random fail the flow upper limit. Upon physical inspection of the station(s) everything appears fine. Upon further investigation it is determined that there are large fluctuations in the static water pressure. It is desired to bump all stations from their existing 15% (above nominal) to 25% (above nominal).

Then

- Set the flow percentage to 25%.
- All station limits will now be recalculated to provide another 25% over the initial nominal readings.

**Note:** *This SETUP function will be skipped if you have not enabled the flow features.*

Example: Assume the initial measured flow (nominal value) was 40 GPM for a station. Because the flow percentage was originally 15% then the station upper limit as retained in the controller is 46 GPM ( $1.15 \times 40$ ). Now, setting the new flow percentage of 25% yields a new station limit of 50 GPM ( $1.25 \times 40$ ).

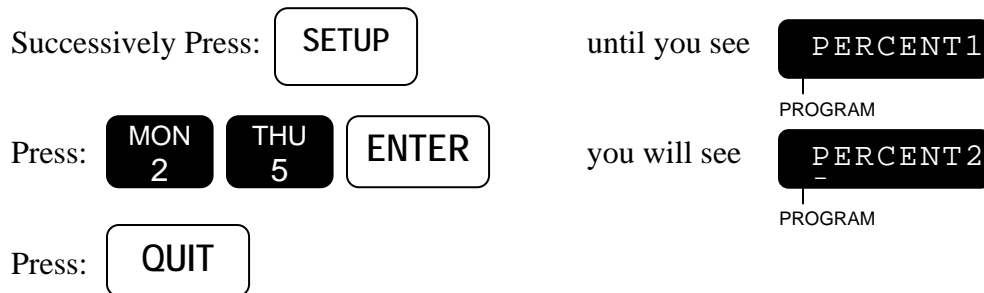

## LIMITS

This feature will allow you to set the station's upper flow limits by either using the LEARN mode or by setting them explicitly. The next 2 sections explain each of these methods.

**Note:** *This SETUP function will be skipped if you have not enabled the flow features.*

## STATION LIMITS USING LEARN MODE

This feature allows the controller to LEARN and set the station upper flow limits.

Controller operation:

- Each station is turned on one at a time. The amount of time it is on is determined by the flow check delay time (1 to 6 minutes).
- The nominal flow reading is established by averaging the measured flow for the last minute in which the station is on.
- The station upper limit is calculated taking the nominal value and adjusting upward by the flow percentage (previously established).

- The new limit is saved in memory (non-volatile RAM).

You just press Enter and the controller will automatically set the upper flow limits by LEARNING them.

EXAMPLE: You wish to setup the controller to LEARN and automatically set all the station upper flow limits. You think 30% is a good amount to add to the upper limits over and above what the controller measures.

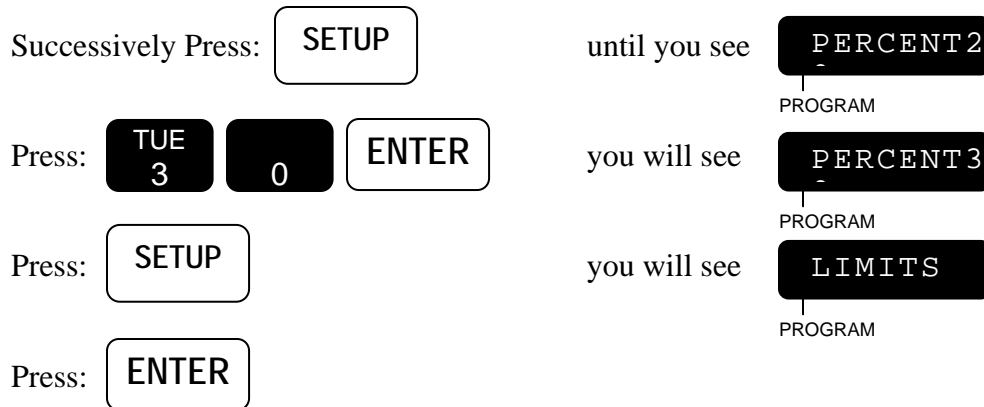

The controller will now LEARN and set up all the upper station flow limits. It will take the Flow Delay time for each station. So, if you have a 36 station controller and your Flow Delay time is 2 minutes, it will take 72 minutes. (If you want the controller to skip to the next station at any time, press MANUAL and the station which was skipped will not have its limit changed). During this time the LED will display which station is watering and the flow in GPM will be on the display.

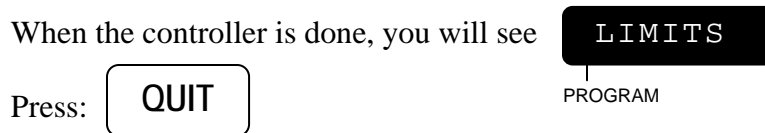

**Note:** While each station is watering, if you have selected a Normally Closed Master Valve, the Master Valve will come on also; if the station is in a program that has a pump assigned to it, the pump (Station 1) will also come on with the station.

**Note:** If you selected Pump for any program, Station 1 will be used for the Pump and the controller will not set an upper flow limit for Station 1.

## SETTING STATION LIMITS

This feature allows you to directly set a station's upper flow limit to any value. It is an alternate to using the LEARN mode described above. In this feature each station limit is set one at a time.

To use this feature:

1. Successively press SETUP until you see LIMITS in the display

2. Press the station number followed by ENTER.

3. You now have the opportunity to set the upper flow limit in one of 2 ways. Pressing Manual will toggle between the 2 ways.

- You can explicitly put in the limit followed by Enter.
- You can press Manual and the controller will start watering the station. During this time the flow rate will be displayed on the left and the limit will be displayed on the right. By pressing Enter you can accept the flow rate as the limit (adjusted up by the flow percentage):

**Note:** *The limit can be set to from 0 to 500 GPM. The set limit will be rounded to the nearest 2, so if for instance you set the limit to 55, when you come back and look at it later it will be 54.*

EXAMPLE 1: You wish to set the upper station flow limit of Station 15 to 44 GPM.

Successively Press: SETUP until you see LIMITS

Press: SUN THU ENTER you will see PROGRAM  
15 - 200

Press: WED WED ENTER you will see PROGRAM  
LIMITS

You can now continue to enter limits for other stations if you wish. When done,

Press: QUIT

EXAMPLE 2: You wish to review the upper station flow limit of station 15.

Successively Press: SETUP until you see LIMITS

Press: SUN THU ENTER you will see PROGRAM  
15 - 044

Press: ENTER (indicating that the limit for Station 15 is 44 GPM) to leave limit as is.

Press: QUIT

EXAMPLE 3: You want to watch Station 7 watering and when you feel it has stabilized you want the flow (adjusted up by the flow percentage) to be used to set the upper flow limit. Your flow percentage has previously been set to 30%.

Successively Press: **SETUP** until you see **LIMITS**  
PROGRAM

Press: **SAT 7** **ENTER** you will see **7-200**  
PROGRAM

Press: **MANUAL**

Station 7 will begin watering. To stop watering at any time, press MANUAL.

**Note:** *If you have selected a Normally Closed Master Valve, the Master Valve will come on also. If Station 7 is in any program which has a pump assigned to it, then the Pump (Station 1) will come on also.*

you will see **052 200**  
PROGRAM

The value on the left is the measured or (nominal) flow and the value on the right is a previously established limit (both in GPM). The flow display will update once every 10 seconds.

You now watch the display until you see that the flow has reached a stable value and you want to use that value (adjusted up by the flow percentage) for your limit.

Suppose the stable value is 45 GPM, then your display will be **045 200**  
PROGRAM

Press: **ENTER** you will see **LIMITS**  
PROGRAM

and your new limit will be 45 adjusted up by 30% which is 58 GPM.

**EXAMPLE 4:** You want to just turn Station 7 on and monitor its flow without changing its upper flow limit.

Successively Press: **SETUP** until you see **LIMITS**  
PROGRAM

Press: **SAT 7** **ENTER** you will see **7-200**  
PROGRAM

Press: **MANUAL**

Station 7 will begin watering and its flow will be displayed. The Master Valve and/or Pump may also be on depending on conditions as described in the previous example.

you will see **052 200**  
PROGRAM

The value on the left is the current flow and will update once every 10 seconds.

Station 7 will remain on and its flow will be monitored until you press MANUAL or QUIT.

when done monitoring,

Press: **MANUAL**

you will see

**7-200**

(to begin watering again you can press MANUAL again)

PROGRAM

Press: **QUIT**

**THIS PAGE INTENTIONALLY LEFT BLANK.**



## TROUBLESHOOTING

Symptom	Action
Display is blank	1. Ensure controller has power and all wires are properly connected.  2. Check secondary voltage of transformer for 24 VAC
No stations turn on automatically	1. Is the controller in Automatic Mode?  If No - Press <span style="border: 1px solid black; border-radius: 10px; padding: 2px 10px;">QUIT</span>  2. Ensure the Rain Switch is in the “Auto Watering” position.  3. Does * appear in left most position of display? Yes - Rain Sensor is enabled and is reading a wet condition (see SETUP)  4. Ensure that the Master Valve, Pump wiring and SETUP is correct (see page 9).  5. Activate Manual System Check (page 42) If station turns on, review programs: (page 39) <ul style="list-style-type: none"> <li>• Water Days</li> <li>• Station Runtimes</li> <li>• Percentage Valid</li> <li>• Start Times</li> </ul>
Display alternates with FAULT...PRESS...REVIEW	A problem with either flow or station field wiring has occurred (see page 43).
A station remains on	Place Rain Switch in “No Watering” position. If station remains on then: <ul style="list-style-type: none"> <li>• Check for dirt in valve’s solenoid which will cause the solenoid to stick</li> <li>• Check for obstructions in valve, or torn diaphragm</li> </ul> If station goes off then: <ul style="list-style-type: none"> <li>• Check station’s programmed watering time</li> <li>• Check program percentage</li> </ul>
Flow reading “000 GPM” when water flowing	Check installation/connections Figure 6 on page 13.
Display never shows “XXX GPM” when water flowing	Flow not enabled. • Check Flow Sensor Setup on page 53

## APPENDIX A

### RAIN MASTER FLOW SENSOR PART NUMBERS

Use the following table to determine the part number for your pipe size.

Pipe Size (inches)	Rain Master Flow Sensor Part Number
1.0	FS-100
1.25	FS-125
1.5	FS-150
2	FS-200
3	FS-300
4	FS-400

## INDEX

### A

Alarm.....	54
Automatic Mode .....	28

### C

Controller Advanced Features .....	5
Controller Basic Features.....	4
Controller Connections – Ac Power .....	9
Controller Connections – Valves And Field Wiring .....	11
Controller Placement.....	9
Cycle And Soak .....	35, 55

### D

Data Keys.....	22
Delay .....	52
Disabling Security Code .....	53

### E

Electrical Grounding For The Controller.....	10
Electrical Specifications.....	17
Eliminating Security Code.....	53
Enabling Security Code .....	53
Entering A New Security Code.....	52
Execute Keys.....	21

### F

Fault Detection Overview .....	45
Flow Check Delay.....	57
Flow Main Fault.....	46
Flow Percentage .....	58
Flow Sensor Features Enabled/Disabled .....	55
Flow Sensor Installation .....	15
Flow Station Fault.....	48
Flow Unscheduled Fault .....	47
Function Keys .....	20

<b>I</b>	
Independent Normally Closed Master Valve and Pump Operation .....	14
<b>K</b>	
Key Operations .....	19
<b>L</b>	
Limits .....	59
<b>M</b>	
Main Line Flow Limit.....	56
Manual Master Valve.....	44
Manual Program.....	43
Manual Station .....	43
Manual System Check/Syringe Cycle .....	44
Master Valve (MV).....	50
Master Valve And Pump Wiring Options.....	11
Master Valve And Pump Wiring Options Matrix.....	11
Monitoring Station Flow.....	45
Mounting The Controller .....	9
<b>N</b>	
Normally Closed Master Valve Operation .....	12
Normally Open Master Valve.....	14
Normally Open Master Valve and Pump Operation.....	15
<b>P</b>	
Percentage .....	38
Pipe.....	56
Program .....	31
Program Clear .....	32
Program Selection .....	31
Programmable Rain.....	29
Pump .....	51
<b>Q</b>	
Quick Stations (for a conventional program) .....	35
Quick Stations (for a cycle and soak program).....	37

**R**

Rain Mode.....	28
Remote Control Capability .....	17
Reviewing Programs And Totalizer.....	41

**S**

Security Code.....	52
Sensor.....	53
Sensor Wiring .....	16
Set Time .....	31
Setting Station Limits .....	60
Simultaneous Normally Closed Master Valve and Pump Operation .....	12
Skip Days .....	33
Stack Or No Stack.....	51
Start Times .....	40
Start Times And Automatic Program Overlap Protection.....	39
Station Limits Using Learn Mode.....	59
Stations ( for a cycle and soak program) .....	36
Stations (for a conventional program) .....	34
Stations And Watering Times.....	33

**T**

Tapping Wires To Locate Valves In The Field .....	16
Totalizer .....	57
Troubleshooting .....	65
Type Of Master Valve.....	50

**U**

Unscheduled Flow Limit.....	56
User Programmable Features (Setup) .....	6

**W**

Water Days.....	32
Watering Day Selections.....	32
Wiring Fault .....	46
Words and Terms Used in the Display .....	23

## RAIN MASTER LIMITED WARRANTY

Rain Master Irrigation Systems Inc. warrants to the first customer purchaser that this Rain Master brand product (the "product"), when shipped in its original container, will be free from defective workmanship, and materials and agrees that it will, at its option, either repair the defect or replace the defective product or part thereof at no charge to the purchaser for parts or labor for the time period set forth below.

This warrant does not apply to any appearance items of the product nor to any product the exterior of which has been damaged, or defaced, which has been subjected to misuse, abnormal service or handling, or which has been altered or modified in design or construction. (See additional exclusion below).

In order to enforce the rights under this limited warranty, the purchaser should ship or carry the product to a Rain Master authorized service depot, or send product prepaid to Rain Master at the address below (ensuring product is packaged correctly for shipment).

**For nearest location, call Rain Master Service Center 1-805-527-4498.**

This limited warrant described above is in addition to whatever implied warranties may be granted to purchasers by law. (All implied warranties including the warranty of merchantability, and fit for use are limited to the period(s) from date of purchase set forth below).

Neither the sales personnel of the seller nor any other person is authorized to make any warranties other than those described above, or to extend the duration of any warranties beyond the time period described herein.

The warranties described above shall be the sole and exclusive warranties granted by Rain Master Irrigation Systems Inc. and shall be the sole and exclusive remedy available to the purchaser. Correction of defects, in the manner and period of time described herein, shall constitute complete fulfillment of all liabilities and responsibilities of Rain Master to the purchaser with respect to the product, and shall constitute full satisfaction of all claims, whether based on contract, negligence, strict liability or otherwise.

In no event shall Rain Master be liable or in any way responsible, for any damages or defects in the product which were caused by repairs or attempted repairs performed by anyone other than a Rain Master service dealer or center. Nor shall Rain Master be liable or in any way responsible for an incidental or consequential economic or property damage. Some states do not allow the exclusion of incidental or consequential damages, so the above exclusion may not apply to you.

This limited warranty does not apply to improper installation or grounding, acts of God, such as lightning and/or power surges, floods, earthquakes, hurricane, tornados, vandalism etc.

Models HK and HK-T carry a 5 year limited warrant from date of purchase

All other Rain Master brand products carry a 2 year limited warranty unless otherwise specified.

### SERVICE

Should it be necessary to require servicing of your controller, contact your local Rain Master distributor or contact Rain Master at 1-805-527-4498 for a listing of distributors in your area.

When sending a controller or a component of the controller back to be serviced, ensure it is properly protected with a soft packaging material, and that the box will withstand normal shipping abuses. Enclose a complete description of the type of problem that is occurring, and be sure to put your name, address and phone number where you can be reached.

**WARNING:** This equipment has been tested and found to comply with the limits for Class A digital device pursuant to Part 15 of the FCC Rules. These limits are designed to provide reasonable protection against harmful interference when the equipment is operated in a commercial environment. This equipment generates, uses, and can radiate radio frequency energy and, if not installed and used in accordance with the instructions manual, may cause interference to radio communications. Operation of this equipment in a residential area is likely to cause interference in which case the user will be required to correct the interference at his own expense.

The user is cautioned that changes and modifications made to the equipment without approval of the manufacturer could void the user's authority to operate this equipment

1825-103 Surveyor Ave.  
Simi Valley, CA 93063

Tel (805) 527-4498  
Fax (805) 527-2813