

OS32C
Safety Laser Scanner



Quick Reference Guide

© OMRON Corporation 2013 All Rights Reserved.

Safety Precautions

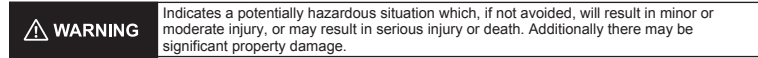
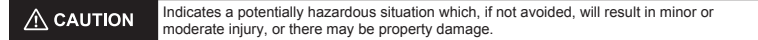
The Alert symbols and their meanings ensure safe use of the products. In order to use the OS32C safely, the precautions listed in this manual are indicated by alert symbols. The descriptions must be followed, failure to follow all precautions and alerts may result in an unsafe installation or operation. The following indications and symbols are used.

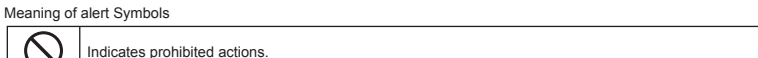
	Indicates a potentially hazardous situation which, if not avoided, will result in minor or moderate injury, or may result in serious injury or death. Additionally there may be significant property damage.
	Indicates a potentially hazardous situation which, if not avoided, will result in minor or moderate injury, or there may be property damage.

	Indicates prohibited actions.
	Indicates mandatory actions.

If more information is needed, refer to the OS32C user's manual (Z296-E1-07).

Alert Statements in this Manual



-  An OS32C is an electro-sensitive protective equipment designed to guard personnel working around hazardous machinery.
-  Whether a specific machine application and the OS32C system installation complies with safety regulations depends on the proper application, installation, maintenance and operation of the OS32C system. These items are the responsibility of the purchaser, installer and user.

- User**
-  The administrator is responsible for the selection and training of personnel to properly install, operate, and maintain the machine and its safeguarding systems.

An OS32C system should only be installed, verified and maintained by a qualified person. A qualified person is defined as "an individual who understands, is trained on, and demonstrates competence with the construction, operation or maintenance of the machinery and the hazards involved." (ANSI/PMMI B155.1-2006)

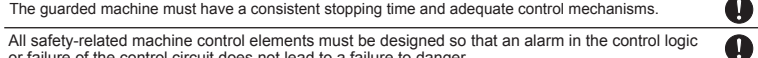
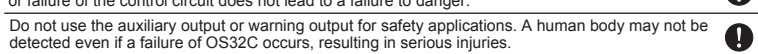
- The machine requirements**
-  The guarded machine must be able to stop anywhere in its cycle. Do not use an OS32C on a press with a full-revolution clutch.
 -  The guarded machine must have a consistent stopping time and adequate control mechanisms.

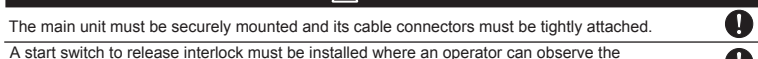
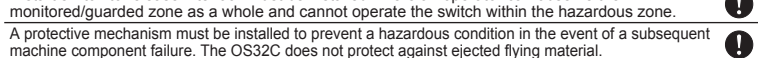
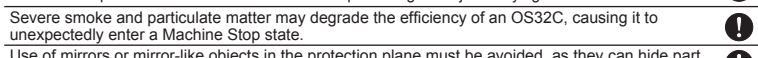
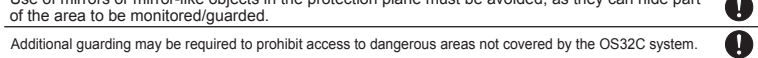
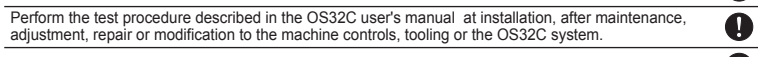
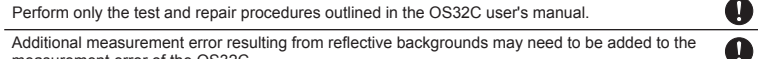
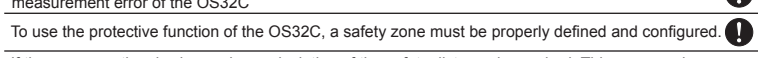
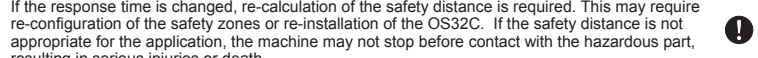
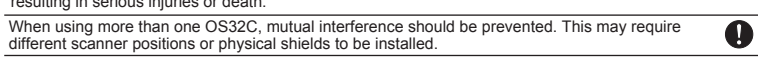
-  All safety-related machine control elements must be designed so that an alarm in the control logic or failure of the control circuit does not lead to a failure to danger.
-  Do not use the auxiliary output or warning output for safety applications. A human body may not be detected even if a failure of OS32C occurs, resulting in serious injuries.

- Installation**
-  The main unit must be securely mounted and its cable connectors must be tightly attached.
 -  A start switch to release interlock must be installed where an operator can observe the monitored/guarded zone as a whole and cannot operate the switch within the hazardous zone.
 -  A protective mechanism must be installed to prevent a hazardous condition in the event of a subsequent machine component failure. The OS32C does not protect against ejected flying material.
 -  Severe smoke and particulate matter may degrade the efficiency of an OS32C, causing it to unexpectedly enter a Machine Stop state.
 -  Use of mirrors or mirror-like objects in the protection plane must be avoided, as they can hide part of the area to be monitored/guarded.
 -  Additional guarding may be required to prohibit access to dangerous areas not covered by the OS32C system.
 -  Perform the test procedure described in the OS32C user's manual at installation, after maintenance, adjustment, repair or modification to the machine controls, tooling or the OS32C system.
 -  Perform only the test and repair procedures outlined in the OS32C user's manual.
 -  Additional measurement error resulting from reflective backgrounds may need to be added to the measurement error of the OS32C.
 -  To use the protective function of the OS32C, a safety zone must be properly defined and configured.
 -  If the response time is changed, re-calculation of the safety distance is required. This may require re-configuration of the safety zones or re-installation of the OS32C. If the safety distance is not appropriate for the application, the machine may not stop before contact with the hazardous part, resulting in serious injuries or death.
 - When using more than one OS32C, mutual interference should be prevented. This may require different scanner positions or physical shields to be installed.

To ensure a protection degree of IP65, DO NOT use this product without proper sealing of the cable connector, I/O block, and scan window.

If the external zone switching device momentarily exceeds the configured number of active zone set select inputs during the zone switch, an additional Zone Delay may be incurred in the event that wiring of a zone set select input fails. The external zone switching device must properly sequence so the configured number of active inputs is not exceeded in order to guarantee that failed zone set select input wiring will be detected within the normal Zone Switching Time.

If an insufficient Zone Delay is used for the actual worst case switching time of the installation, the scanner might start monitoring the wrong zone during the switching period. Also, if an insufficient Zone Delay is used for the actual worst case switching time of the installation, there might be a fault condition during the zone switching period.

If tstart (switching start time) is configured without consideration of TmaxReaction (total maximum reaction time), object detection within the new safety zone after switching and turning OFF of the safety outputs may be delayed.

Monitoring zone parameters are subject to a number of constraints that include projective consistency, maximum radius, and angle limits. As a result, an imported zone may not correspond exactly to the zone defined in the file. The user must visually verify the imported zone when the zone coordinate import process is complete. Refer to Checkout and Test Procedure Log in the OS32C user's manual.

Others

 **WARNING**
Do not modify the main unit of the OS32C. Do not replace or fix any component of the OS32C other than the ones specified in the user's manual. Doing so may result in a failure of the device to function correctly.

If there is any damage to the window, replace it as soon as possible. Otherwise it may result in a failure of the OS32C. Take preventive measures when performing replacement work so that dust does not enter the OS32C.

Always detach all cables from the OS32C before replacing the scan window. Otherwise the motor may start rotating, resulting in injuries.

The test outlined in this test procedure (See "Checkout and Test Procedure Log" in the OS32C user's manual) must be performed at time of installation, according to the employer's regular inspection program and after any maintenance, tooling change, set up, adjustment, or modification to the OS32C system or the guarded machine. Where a guarded machine is used by multiple operators or shifts, it is suggested that the test procedure be performed at each shift or operation change and also if there is a change in the OS32C operating mode or defined zone sets. Testing ensures that the safety laser scanner and the machine control system are working properly to stop the machine. Failure to test properly could result in serious injury to personnel.

If the OS32C is operated under automatic start, make sure that the machine stops and does not restart as long as an object is detected in a safety zone. Check the operation by placing a test piece into the safety zone. It is recommended to perform the test at least after a shift change or 24 hours of operation.

If the safety system or the machine fails any of these tests, do not run the machine. Immediately tag or lock out the machine to prevent its use and notify the appropriate supervisor.

This laser scanner may not be sold or imported into, or used in, the Federal Republic of Germany prior to December 1, 2013.

System and zone status parameters monitored over EtherNet/IP are to be used for diagnostic purposes only, and must not be used in safety-critical functions.

Measurement data monitored over EtherNet/IP are to be used for diagnostic purposes only, and must not be used in safety-critical functions.

 **CAUTION**
When transferring data from the PC to the OS32C and more than one OS32C is connected to the network, it is necessary to visually check the diagnostic code on the status/diagnostic display. It is recommended that the OS32C be installed in a position where the status/diagnostic display will be visible.

Take precautions to prevent dirt, dust or debris from entering the sensor and I/O block connectors. It is recommended that this be done on a clean workstation as contaminants may degrade the performance of the OS32C.

Adhesion of dust to the scan window may cause a false operation. The OS32C will require periodic cleaning of the scan window and dust detection surface.

Operation of the OS32C may be affected by light in the environment, such as incandescent light, strobe light and light from a photosensor using infrared light.

Operation of the OS32C may be affected by substances in the environment, such as fog, smoke, steam and other small particles.

Ensure the measurement report configuration matches the expected measurement data format.

System Components

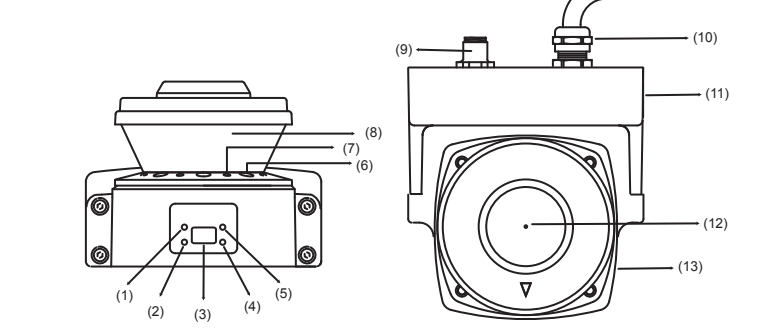

No.	Component	Function
(1)	RUN output indicator (green)	Will turn ON when safety zone is clear and OSSDs are ON.
(2)	Interlock Indicator (yellow)	Will turn ON when in interlock state, blink under lockout, and blink in case of a failure.
(3)	Status/Diagnostic Display	The scanner's status, configuration/operation, or failure is displayed
(4)	Warning Output Indicator (orange)	Will turn ON when the warning output is ON.
(5)	STOP output indicator (red)	Will turn ON when safety zone is blocked, OSSD are OFF or under interlock state.
(6)	Dust Ring	Dust detection cover with reflective surface, for dust accumulation detection
(7)	Individual Sector Indicators	Will turn ON when an intrusion is detected in the safety zone, 8 sectors total. Each sector = 33.75°.
(8)	Scan Window	The window where the laser light is emitted and received.
(9)	Communication Connector	Provides for Ethernet interface.*1
(10)	Power Connector	For power connections, 18-pin connector (pigtail). *1
(11)	I/O Block	Connector module
(12)	Center of Rotation	Indicates the location of the axis around which the laser irradiates from.
(13)	Sensor	Sensor Head; field replaceable.

*1: The communication and power connections can also be mounted on the left side of the I/O block.

OS32C Dimensions

Model (OS32C-BP) shown

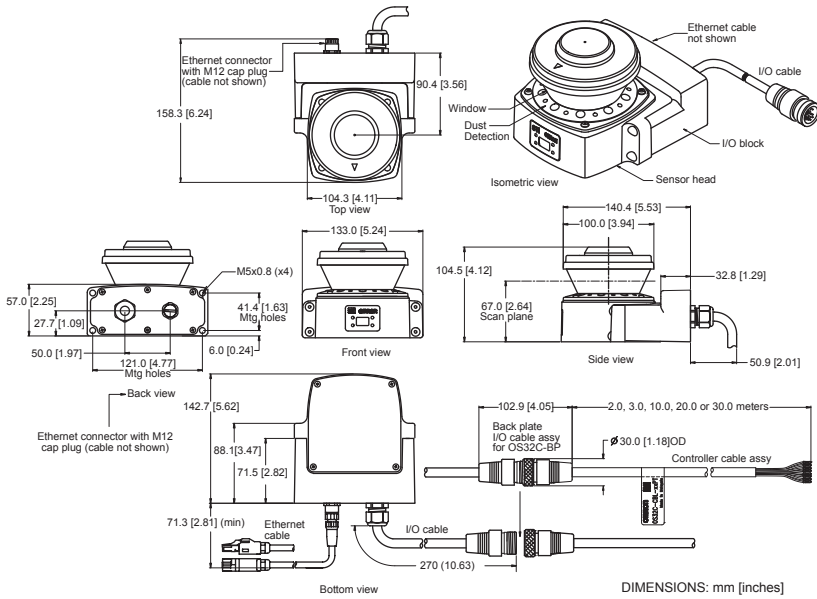

Rating/Performance

Sensor Type	Type 3 Safety Laser Scanner
Safety Category	Category 3, Performance Level d (ISO13849-1:2008)
Functional Safety of Electrical/Electronic/Programmable Electronic Safety-related Systems	SIL 2 (IEC61508)
Detection Capability	Configurable; Non-transparent with a diameter of 30, 40, 50, 70mm (1.8% reflectivity or greater)
Monitoring Zone	Monitoring Zone Set Count (Safety Zone + 2 Warning Zones) : 70 sets max.
Operating Range	Safety Zone : 1.75m (30mm res.), 2.5m (40mm res.), 3.0m (50mm or 70mm res.) Warning Zone : 10.0m
Maximum Measurement Error	100mm *1
Detection Angle	270°
Angular Resolution	0.4 degree
Laser Beam Diameter	6mm at optics cover, 14mm (typical) at 3m.
Laser Scan Plane Height	67mm from the bottom of the scanner (see "OS32C Dimensions" above for more detail)
Response Time	Response time from ON → OFF: From 80 ms (2 scans) to 680ms (up to 17 scans) Response time from OFF → ON: Configurable.
Zone Switching Time	From 20 to 320ms
Line voltage	24VDC +25%/-30% (ripple p-p 2.5V max.) *2
Power Consumption	Normal operation: 5Wmax., 4W typical (without output load)*3 Standby mode: 3.75W (without output load)
Emission Source (Wavelength)	Infrared Laser Diode (905nm)
Laser Protection Class	Class 1 : IEC/EN60825-1(2007) Class 1 : JIS 6802(2005) Class I : CFR21 1040.10, 1040.11
Safety Output (OSSD)	PNP transistor x 2, load current of 250mA max., residual voltage of 2V max., load capacitance of 2.2 μf max., leak current of 1mA max *3, *4, *5.
Auxiliary Output (Non-Safety)	NPN/PNP transistor x 1, load current of 100mA max., residual voltage of 2V max., leak current of 1mA max *4, 5, 7
Warning Output (Non-Safety)	NPN/PNP transistor x 1, load current of 100mA max., residual voltage of 2V max., leak current of 1mA max *4, 5, 7
Operation Mode	Auto Start, Start Interlock, Start/Restart Interlock
External Device Monitoring	ON: 0V short (input current of 50mA), OFF: Open
Start	ON: 0V short (input current of 20mA), OFF: Open
Zone Select	ON: 24V short (input current of 5mA), OFF: Open
Standby	ON: 24V short (input current of 5mA max.), OFF: Open
Connection Type	Power Cable: 18-pin mini-connector (pigtail) Communication Cable: M12, 4-pin connector
Connection with PC	Communication: Ethernet *6 OS Supported: Windows 2000, Windows XP, Windows Vista, Windows 7
Indicators	RUN Indicator : Green, STOP Indicator : Red, Interlock Indicator : Yellow, Warning/Auxiliary Output Indicator : Orange Status/Diagnostic Display: 2 x 7-segment LEDs Individual Sector Indicators: Red LED x 8
Protective Circuit	Protection against output load short and reverse power connection
Ambient Temperature	Operation: -10 to 50 deg. C, Storage: -25 to 70 deg. C
Ambient Humidity	Operation & Storage: 95%RH max., non-condensing
Ambient Operation Illumination	Incandescent lamp: Illumination on receiving surface 1500lx max. (an angle of laser scanning plane and disturbance light must be +/-5 degrees or more)
Insulation resistance	20Mega-ohm or higher (500VDC)
Dielectric withstand voltage	350VAC, 50/60Hz, 1 minute
Enclosure Rating	IP65(IEC60529)
Enclosure	Sensor Head: Die-cast aluminum Optics Cover: Polycarbonate I/O Block: Die-cast aluminum
Dimensions (WxHxD)	133.0 x 104.5 x 142.7mm (except cable)
Impact Resistance	98m/s² 1000 times for each of X, Y, and Z directions (IEC60068-2-29)
Vibration	10-55Hz double-amplitude of 0.7mm, 20 sweepings for X, Y, and Z directions (IEC60068-2-6)
Weight (Main Unit only)	1.3kg
Power Cable	Up to 30m
Communication Cable	Up to 100m for 100 BASE-T Cat 5 cable
Approvals	Certified by: TÜV Rheinland, UL Major Standards: IEC61496-1/-3 Type 3, ISO13849-1:2008 Category 3, UL508, UL1998

- *1. An additional measurement error may need to be added due to reflective backgrounds (See user's manual for details).
- *2. For power source specification, see Power Supply Unit in the OS32C user's manual.
- *3. Rated current of OS32C is 1.025A max. (OS32C 210mA + OSSD A load + OSSD B load + Auxiliary output load + Warning output load + Functional Inputs).
Where functional inputs are:
EDM input ... 50mA
Start input ... 20mA
Standby input ... 5mA
Zone X input ... 5mA x 8 (eight zone set select inputs)
- *4. Output voltage is Input voltage - 2.0VDC.
- *5. Total consumption current of 2 OSSDs, auxiliary output, and warning output must not exceed 700mA.
- *6. An ethernet cable with an M12, 4-pin connector is required.
- *7. Output polarity (NPN/PNP) is configurable via the configuration tool.

Mounting Considerations

 **CAUTION**
Operation of the OS32C may be affected by light in the environment, such as incandescent light, strobe light and light from a photosensor using infrared light.

Operation of the OS32C may be affected by substances in the environment, such as fog, smoke, steam and other small particles.

The following considerations should be taken into account when determining the mounting location for the OS32C. It is possible for ambient light to interfere with normal operation of the OS32C. Ambient light interference DOES NOT lead to a loss of safety, it may, however, cause false nuisance stops of the guarded equipment. Some installations may require that the OS32C be mounted in direct exposure to ambient light. In these situations you must assure that the separation between the scan plane of the OS32C and the light source be greater than +/-5°.

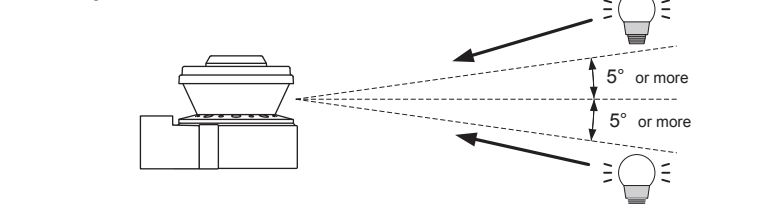

Configuring Multiple OS32C Scanners

The possibility exists that two OS32C may interfere with each other. To avoid this when using multiple OS32C in the same location, please review the following mounting recommendations.

- Adjust the scanners to offset the scanning plane by tilting the OS32Cs.
- Adjust the scanners to offset the scanning plane by mounting the OS32Cs at different heights.
- Adjust the scanners to different scanning planes and additional sampling scans (response time) on the OS32Cs.
- Install a barrier to block the direct path of possible signal crossing.

Offset Scanning Level by Tilting

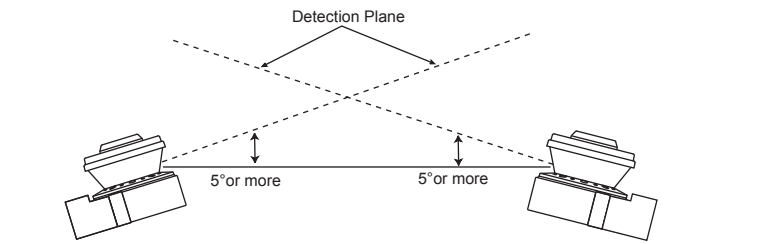

Offset Parallel Scanning Levels by Different Installation Height

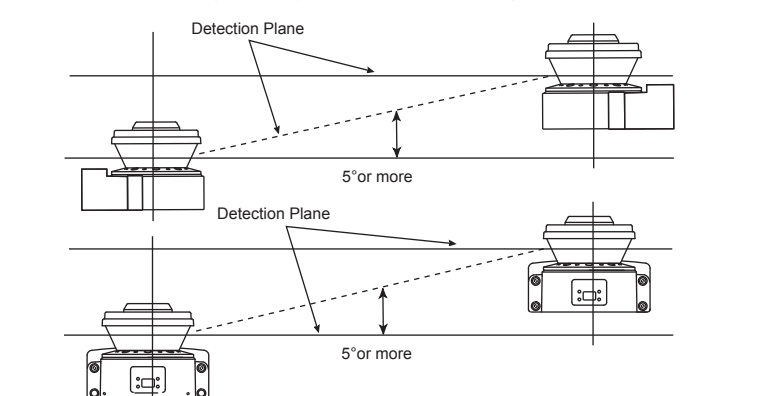

 CHECK
When installing the OS32Cs side by side, it is more effective to set their mounting heights differently. When adjusting the OS32C tilted, it may be more effective to adjust the OS32C downward depending on the condition of the outside light source (natural light or halogen light).

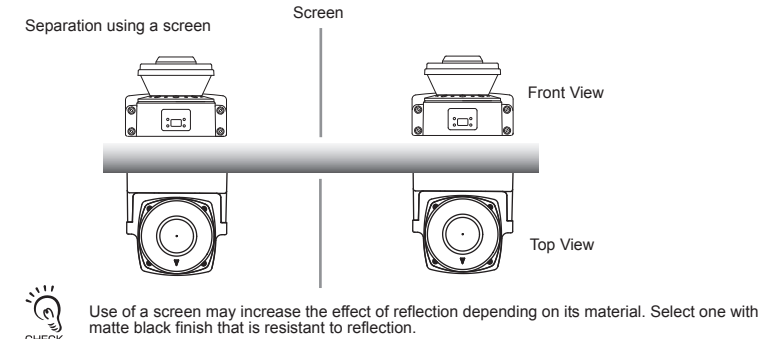

Stationary Installation

When using the OS32C to detect the hazardous area, the Start/Restart Interlock mode should be selected; the regulations applying to the machine must also be complied with.

Safety Distance (Required Depth of Safety Zone)

Always configure the safety zone in such a way that the machine comes to a standstill in a time less than that taken to reach the danger point of the machine after infringing (interrupting) the safety zone. The standard ISO 13855-2005 (EN 999-1998) must be used to calculate the minimum safety distance; according to ISO 13855-2005 (EN 999-1998), the minimum safety distance, S, from the danger zone area to the outer edge of the safety zone is calculated as follows:

$$S = (K \times T) + C + Z$$

where:
S = Minimum safety distance in mm measured from the danger area to the outer contour of the safety zone.

K = Movement or approach speed in mm/s (constant K = 1600 mm/s)

T = Delay between interruption of the safety zone and standstill of the machine in seconds consisting of the sum of t1, t2 and t3:

t1 = Response time of the OS32C

t2 = Rundown time of the machine (mechanical rundown, reaction time of control system)

t3 = additional time delay for use when multiple zones are used (t3 = 10 ms.)

C = Safety constant with C = 1200 mm - 0.4 x H (C ≥ 850); where

H = Distance of detection level from reference level in mm

Z = Additional safety factors (maximum measurement error) (Z = Z1 + Z2)

Z1 = The OS32C's maximum measurement error (100 mm)

Z2 = Additional error by reflective background

Refer to the OS32C user's manual for additional Error by Reflective Background.

Documentation of Configuration Parameters

The person responsible for the set-up must record the configuration parameters, print out and sign the report.

- Connect the printer to the PC.
- Select the menu "File/Print Configuration" in the configuration software.
- The report is printed out.
- Sign and date the report and file it in a known location which is always accessible.

Stationary Installation Example

An example of the installation of OS32C without undercut on the machine is shown below.

Installation on a Machine

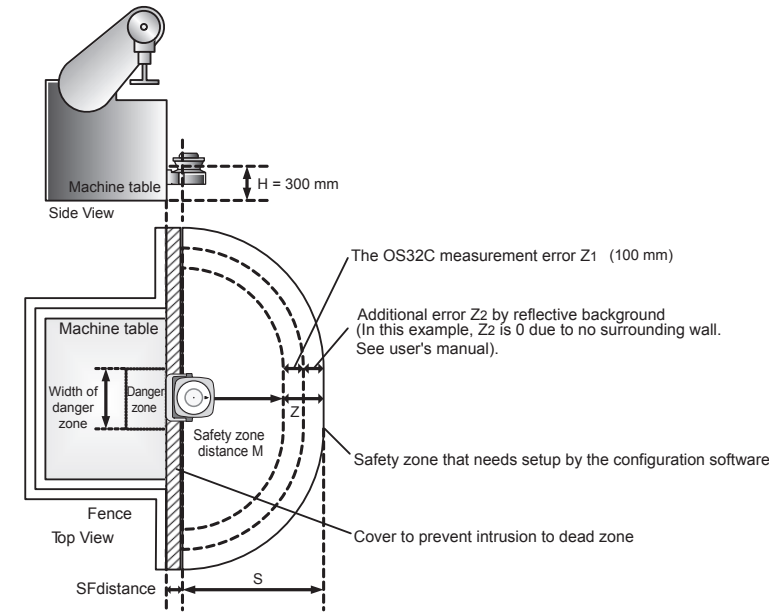

Specifications

K = 1600mm/s: Movement or approach speed (mm/s)

T = t1 + t2

t1 = 0.08s: Response time of OS32C (s)

t2 = 0.2s: Stop time including response time of machine (s)

C = 1200mm - 0.4xH (C ≥ 850mm): safety factor (mm)

H = 300mm: Distance of detected level from reference level (mm)

Z = Z1 + Z2

Z1 = 100mm: OS32C's measurement error (mm)

Z2 = 0mm: Additional error by reflective background (mm)

Mobile Installation for Automated Guided Vehicles (AGV)

Safety Distance (Safety zone depth required for safety zone)

For calculating the minimum safety distance for AGV, the standard IEC 61496-3 can be used. The safety distance, S, for use with an AGV should be calculated using the following formula:

S = Minimum safety distance in mm measured from the danger area to the outer contour of the safety zone.

Sp = Maximum stopping distance for AGV (mm)

Z = Additional safety factors (maximum measurement error)

With the conditions above, the minimum safety distance S is calculated as follows:

$$S = Sp + Z$$

$$Sp = (Vmax \times T) + Sbrake$$

$$Z = Z1 + Z2 + Zgc + Zbf$$

Vmax = Maximum speed of AGV in mm/s

T = Response time consisting of sum of t1, t2 and t3:

t1 = Response time of OS32C

t2 = Response time of AGV

t3 = additional time delay for use when multiple zones are used (t3 = 10 ms.)

Sbrake = Braking distance of AGV in mm based on manufacturer's document

Z1 = OS32C's measurement error (100mm)

Z2 = Additional error by reflective background

Refer to OS32C user's manual - Additional Error due to Reflective Background)

Zgc = Safety factor for lack of clearance between under surface of AGV and ground. See figure below.

Zbf = Safe factor for reduction of brake force of the AGV through wear and usage.

Safety Factor for Low Ground Clearance

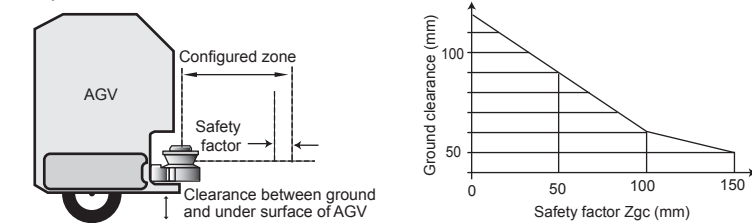

Safety Distance (Width Required for Safety Zone)

Sw = Minimum safety distance of safety zone width (mm)

Vw = Width of AGV (mm)

Z = Additional safety factors (maximum measurement error)

With the conditions above, the minimum safety distance Sw of safety zone width is calculated as follows:

$$Sw = Vw + 2 \times Z$$

Testing the Safety Area

WARNING

If the OS32C is operating in automatic start mode, make sure that the machine stops and not restart when the test object is in the safety zone. Check its operation by approach of a test object into a safety zone. It is recommended that this test be performed after a shift change or 24 hours of operation.

To test the OS32C's detection capability, guide the test object along the perimeter of the safety detection zone as shown in the figure below. The hazardous motion of the guarded equipment must stop immediately (within the pre-determined accepted stop times). While in Automatic Start Mode, the OS32C MUST remain in the machine stop state throughout the entire test. To test the OS32C, use a test object with a diameter appropriate for the selected resolution. (A test object does not come with the OS32C).

Testing a Horizontal Safety Zone

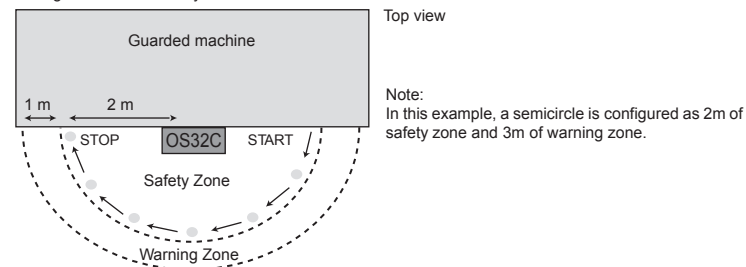

Verify that all indicators and displays are operating properly and correspond to their defined functions of the OS32C. Inspect the OS32C housing and the exit window for signs of damage or manipulation.

If the OS32C is used in a stationary guarding application, ensure that the safety zone(s) are clearly marked on the floor. For mobile applications, make sure that the vehicle stops moving within the limits set in the initial configuration.

If the OS32C fails any of these tests, lock out the guarded equipment and contact the factory supervisor immediately.

Wiring Connections

WARNING

Do not connect the OS32C to a power supply with more than 24VDC + 25% / -30%. Do not supply AC power to the OS32C, this may result in electrical shock.

For the OS32C to meet IEC 61496-1 and UL 508, its DC power supply unit must satisfy all of the following conditions:

- Within rated line voltage (24 VDC +25% / -30%)
- Complying with EMC directives (industrial environments)
- Double-insulation or reinforced insulation between primary and secondary circuits
- Automatic return for overcurrent protection
- Output retention time of 20 ms or longer
- Satisfying output characteristics requirements of Class 2 circuit or limited voltage/current circuit defined in UL508.
- Power supply complying with regulations and standards of EMC and safety country or a region where OS32C is used. (Example of electrical equipment in EU, a power supply must comply with EMC directives for low-voltage)

To prevent electrical shock, use double-insulation or reinforced insulation from hazardous voltage (such as 230 VAC).

Cable extensions must be within the specified lengths, otherwise it may result in a failure of the safety functions.

To use this product for a category 3 safety system, both safety outputs must be connected to the safety system. Configuring a safety system with only one safety output may result in serious injuries due to output circuit fault and a failure of the machine to stop.

Protection of Cable at Installation:

Care should be taken when installing the OS32C cable. The cable must be properly routed and secured to ensure that damage does not occur.

Functional Earth:

The OS32C system requires a functional earth connection.

Do not connect Functional Earth to a positive ground system. If it is connected to positive ground, the guarded machine to be controlled may NOT stop, resulting in severe operator injury.

Signal Connector Isolation:

The connectors used during installation **must** provide sufficient signal separation in order to prevent a short circuit condition of the input power and system signals.

- Basic connection (with single OS32C unit)
Category 3, Performance Level d(ISO13849-1)

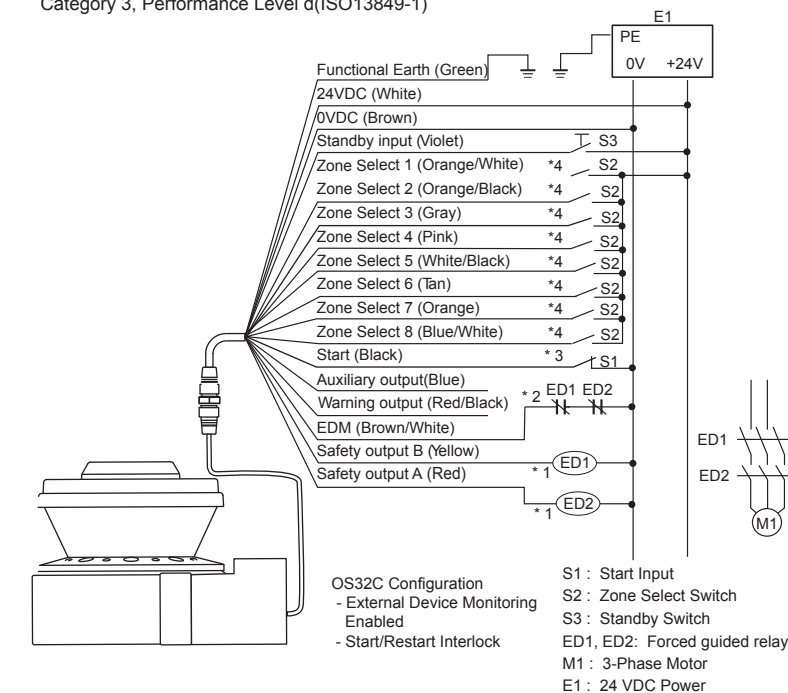

*1. The External Devices ED1 and ED2 are force-guided relays. (e.g. G7Z, G7SA or G7S)

*2. If the External Device Monitoring is not used, connect brown/white wires to 0V, and then turn OFF the External Device Monitoring with the configuration software.

*3. The Start Input must be a Normally Closed switch.

*4. For zone select switch setting, see Zone Set Input Selection. When using only one zone, no connection is needed for the zone select inputs.



This wiring example is for category 3.

OS32C Status Check

The OS32C has the status/diagnostic display on the front, which indicates configuration/error status of the OS32C.

	Diagnostic Code		Corrective Action
Normal Operation	88	Power up indication	-
	--	Normal operation (guarded machine stop)	-
	-- blinking at a slow rate	Standby mode (guarded machine stop). The rate of blinking depends on the mode.	-
	01	Interlock state (waiting for start input)	
	02	Configuration mode (guarded machine stop)	-
	80	Window contamination indication (guarded machine stop)	The window is dirty or scratched, clean or replace as necessary
Safety output fault	70	Incorrect number of active zone inputs (guarded machine stop)	Check zone set select input wiring, zone configuration selection, zone set select input switching time and zone delay configuration
	71	Invalid or undefined zone input combination but correct number of active zone inputs (guarded machine stop)	Check zone set select input wiring, zone configuration selection, zone set select input switching time and zone delay configuration
	□□	Refer to Status/Diagnostic Display Indication of the OS32C user's manual	
	30	Safety output fault	Check output connection and wiring
External device monitoring fault	32	Safety output A is short-circuited to 24V	
	33	Safety output B is short-circuited to 24V	
	34	Safety output A is short-circuited to 0V	
	35	Safety output B is short-circuited to 0V	
	40	EDM (external device monitoring) fault	Check output external device monitoring connection and wiring.
Other fault	41	External device monitoring fault before OSSD turning ON	Check the NC-contact status of the external device is changing state before the OSSDs turning ON.
	42	External device monitoring fault after OSSD turning ON	Check the NC-contact status of the external device is changing state after the OSSDs turning ON.
	43	External device monitoring fault during OS32C power on	Check the OS32Cs output configuration, connections and wiring.
	50	Affected by noise or disturbance light. Or internal fault.	If window was just replaced, perform window calibration. Check the environment if any noise or disturbance light is coming in. Or consult factory.
51	Mutual interference	Mounting Considerations of the OS2C user's manual	
52	Possible electrical noise interference or internal fault.	Check the environment for electrical noise sources or repair the unit. Or consult factory.	
53			
54			
55			
56			
57			
58			
59	The unit was possibly jarred or bumped.	Check the environment if any jarring or bumping occurs.	
60	Invalid configuration in unit	Reconfigure unit or double check current configuration.	
72	Incorrect number of active zone inputs (hard fault code after diagnostic code 70 above persists for more than 10 minutes)	Check zone set select input wiring and zone configuration selection.	
73	Invalid or undefined zone set select input combination, but correct number of active zone set select inputs.(hard fault code after diagnostic code 71 persists for more than 10 minutes)	Check zone set select input wiring and zone configuration selection.	
74	Standby input or zone inputs voltage too high	Check zone set select inputs or standby input wired at more than system power (24 VDC).	
75	Scanner chassis connected to power (24 VDC).	Scanner chassis should be grounded to 0 VDC .	
82	Window not detected or entire dust detection surface is dirty or blocked.	Check that the window is properly mounted and clean the dust detection surface.	
90	Internal temperature fault	The scanner internal temperature exceeds the operating limit. Add more ventilation.	

EUROPE

OMRON EUROPE B.V.
Wegalaan 67-69-2132 JD Hoofddorp, The Netherlands
Phone: 31-2356-81-300 Fax: 31-2356-81-388

NORTH AMERICA

OMRON SCIENTIFIC TECHNOLOGIES INC.
6550 Dumbarton Circle, Fremont, CA 94555-3605 U.S.A.
Phone:1-510-608-3400 Fax: 1-510-744-1442

ASIA-PACIFIC

OMRON ASIA PACIFIC PTE. LTD.
No. 438A Alexandra Road #05-05-(Lobby 2),
Alexandra Technopark, Singapore 119967
Phone: 65-6835-3011 Fax: 65-6835-2711

CHINA

OMRON(CHINA) CO., LTD.
Room 2211, Bank of China Tower, 200 Yin Cheng Zhong Road,
PuDong New Area, Shanghai, 200120, China
Phone: 86-21-5037-2222 Fax: 86-21-5037-2200

OMRON Corporation