

SINGER

307 G

For correct maintenance it is recommended that a good lubricating oil be used at all times. Effortless running, trouble-free operation and long life are thus assured.

For your 307 G machine use

SINGER*OIL

Type A or Type C, which is sold at all Singer Industrial Division addresses.

INSTRUCTIONS FOR USING

SINGER*

MODEL 307 G

combination zig-zag sewing machine for tailoring.

THE SINGER COMPANY

* A Trademark of THE SINGER COMPANY

Printed in U.S.A

Key to parts illustrated in Fig. 1

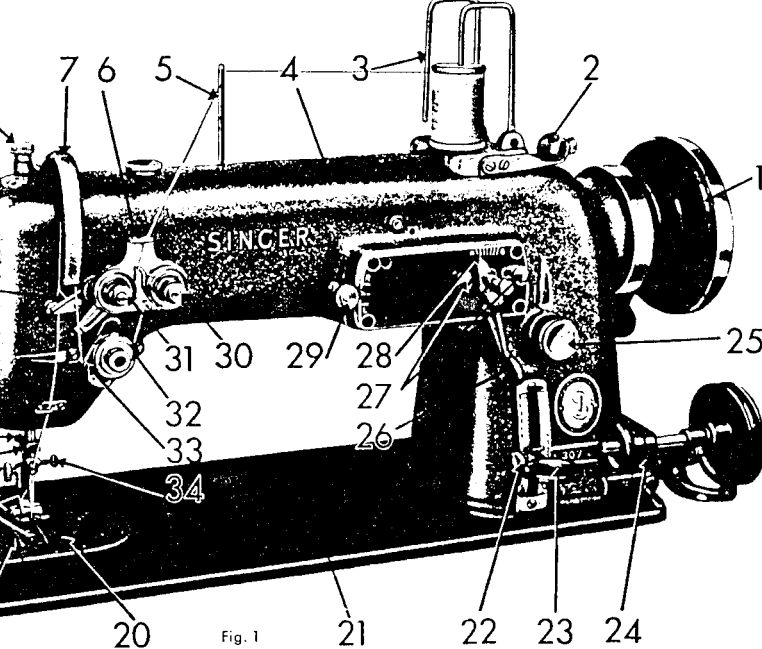

Fig. 1

- | | |
|--|---|
| 1. Machine pulley | 18. Sliding throat plate |
| 2. Bobbin thread guide with tension | 19. Feed dog |
| 3. Twin spool holder | 20. Throat plate |
| 4. Arm | 21. Bed |
| 5. Spool pin | 22. Stitch regulator stop screw |
| 6. Needle thread tension guide | 23. Stitch regulator with scale |
| 7. Thread take-up lever with guard plate | 24. Bobbin winder (treadle operated machines) |
| 8. Pressure regulating thumb screw | 25. Stitch regulator limit screw |
| 9. Face plate screw, upper | 26. Bight control lever |
| 10. Face plate | 27. Maximum bight stop screws |
| 11. Thread guide, upper | 28. Bight indicator scale |
| 12. Thread guide, lower | 29. Needle position lever |
| 13. Face plate screw, lower | 30. Needle thread tension |
| 14. Thread cutter | 31. Buttonhole tension |
| 15. Presser bar | 32. Thread tension spring disc |
| 16. Presser foot thumb screw | 33. Thread take-up spring |
| 17. Hinged presser foot | 34. Needle clamp |

Figure	Part No.	Description
1	506818	Hinged presser foot *
2	188740	Presser foot for guides
a	35002	Presser foot for extension
b	35005	R. H. guide, 2 cm long, deep guide edge
c	35006	R. H. guide, 2 cm long, shallow guide edge
d	35004	R. H. guide, 3 cm long, deep guide edge
e	35003	L. H. guide, 3 cm long, deep guide edge
f	188658	R. H. guide, 6 cm long, shallow guide edge
3	188657	Seam guide
4	50190--819	Seam guide thumb screw
5	503533	Oil can, filled
6	293--985	Allen wrench for belt guard screw
7	120378	Screwdriver, small
8	503505	Screwdriver, large

Also included in the accessories are:

6 needles* Cat. No. 3355 (135×17) sizes 14, 16 and 19; 5 bobbins*, instruction book and accessory case.

* The hinged presser foot, one Needle, Cat. No. 3355 (135 × 17) size 16, and one bobbin come installed when the machine is delivered.

All rights reserved to change accessories.

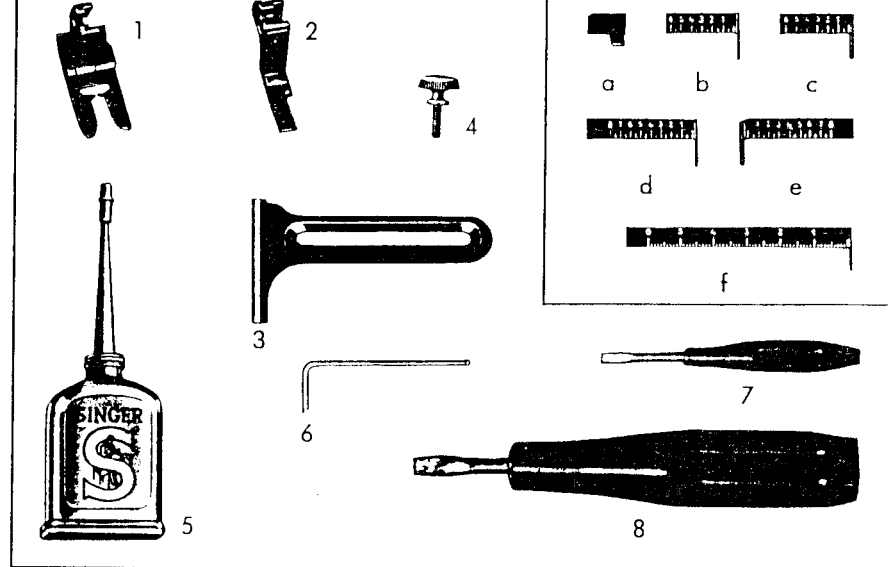

Fig. 2

Additional Accessories (Fig. 3) available at extra cost

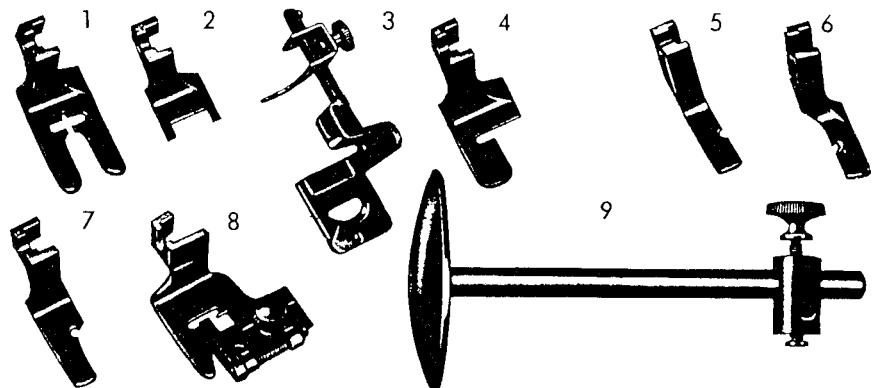

Figure	Part No.	Description as per Instruction Book	Description as per List of Parts
1	188661	Tacking Foot	Presser Foot (solid) for Zig-Zag Work
2	188659	Button sew-on Foot	Presser Foot (solid) for Button Sewing
3	506712	Straight Button Hole Foot	Presser Foot for Button Holes
4	188660	Presser Foot for Overedge stitching	Presser Foot (solid) for Edge Quilting
5	160347	Zipper and Cording Foot, right side	Presser Foot (Edge Stitching), needle hole on right side, for 1/4 in. stitching margin
6	160348	Zipper and Cording Foot, left side	Presser Foot (Edge Stitching), needle hole on left side, for 1/2 in. stitching margin
7	506808	Straight Seams Foot	Presser Foot (solid) for Straight Stitching
8	188697	Blind Stitch Foot	Presser Foot for Blind Stitching
9	503530	Spool Holder	Spool Holder

Air Tucking Attachment, Cpl., No. 506819 (Fig. 4)

available at extra cost

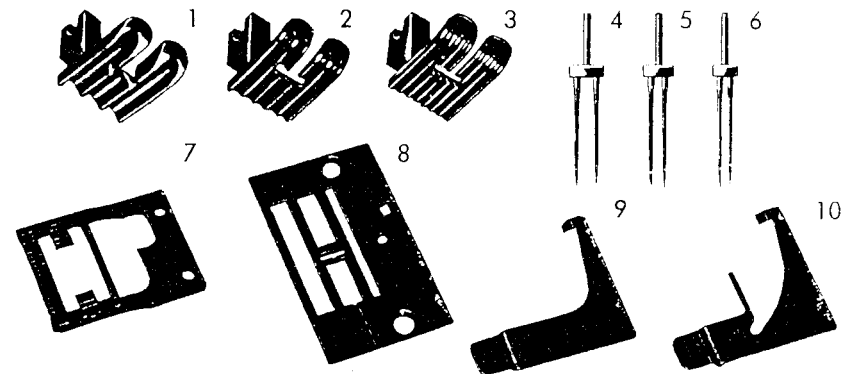

Figure	Part No.	Description as per Instruction Book	Description as per List of Parts
1	506709	Foot, for wide tucks	Air Tucking Foot (for wide tucks)
2	506704	Foot, for medium tucks	Air Tucking Foot (for medium tucks)
3	506705	Foot, for narrow tucks	Air Tucking Foot (for narrow tucks)
4	Cat. No. 3365		Twin Needle for Air Tucks (or for straight seams)
5	Cat. No. 3365		Twin Needle for narrow Air Tucks (or for 1.5 mm zig-zag work)
6	Cat. No. 3365		Twin Needle for medium Air Tucks (or for 2.5 mm zig zag work)
7	506820		Air Tucking Feed Dog
8	506821		Air Tucking Throat Plate
9	506822		Air Tucking Cover Plate
10	506823		Air Tucking Cover Plate with Tongue

Felling Attachment, Complete, No. 188724 (Fig. 5)

available at extra cost

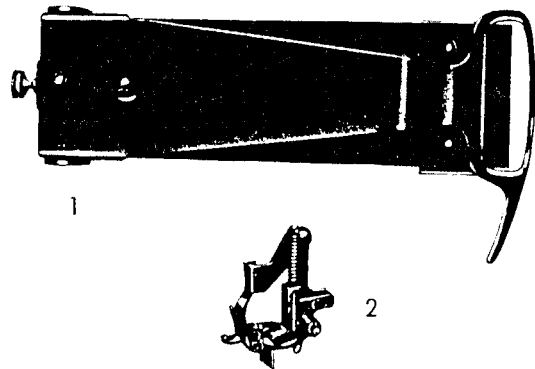

Figure	Part No.	Description as per Instruction Book	Description as per List of Parts
1	188723	Felling Guide	Feller Clamp
2	188710	Felling Foot (automatic)	Blind Stitch Foot

INDEX

I. General Instructions	10
II. Lubrication and Cleaning	24
III. Working with a straight stitch (Hinged foot)	28
IV. Working with a straight stitch (Presser foot with guide)	28
V. Working with a straight stitch (Zipper & Cording foot, R. H.)	32
VI. Zig-Zag stitching with the hinged foot and Applique	33
VII. Overedging	35
VIII. Bar Tacking	36
IX. Sewing on buttons	37
X. Blind stitching	38
XI. Applying interfacing	43
XII. Felling, lapels and collars (Blind stitching)	45
XIII. Making buttonholes	50
XIV. Air tucking	52
XV. Needle and Thread	56

I. General Instructions

Pulley Direction: The machine pulley must turn counter-clockwise, i. e. from right to left, in the direction of the operator.

Type of Needle: The machine uses SINGER needle (Cat. No. 3355 135 X 17). The correct choice of needle size to be used may be determined by checking the NEEDLE TABLE on the last page of this booklet.

Needle Quality: Imitation or inferior quality needles may contribute to excessive tearing of the threads, poor stitching and uneven, rough seams. It is recommended that SINGER needles be used exclusively for this machine. "SINGER Shops or Sewing Centers" carry a complete stock of all sizes, to suit your requirements.

To set the needle: Insert needle into needle clamp as far as it will go, with the long groove towards you. Then tighten needle clamp thumb screw. Incorrect needle position will cause poor stitching.

Placing of the thread spools (Fig. 6): For large size wooden spools and even larger, cross-wound spools use the twin-holding arms A and B. To insert spools, tilt hinged arms toward right. Smaller wooden spools or silk thread spools are to be placed over the forward spool pin C. In case large cones are to be used, support D is required, and is available as an optional accessory.

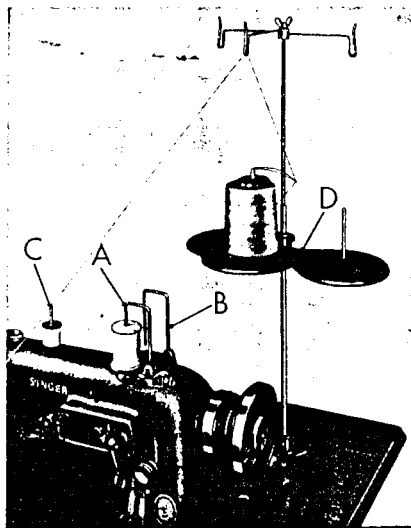

Fig. 6 Placing the thread spools

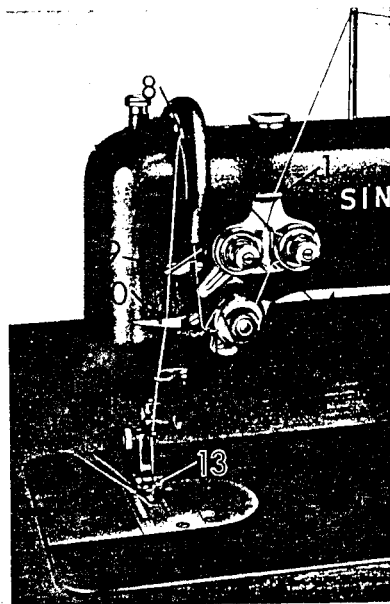

Fig. 7 Upper threading

Upper threading (Fig. 7): Raise the take-up lever to its highest point. Place spool of thread on spool pin, lead through eye on spool pin C, Fig. 6, then:

1. lead through thread tension guide 1
2. from left and under the curved pin 2
3. between tension discs 3, from left to right (the left tension is used exclusively for sewing buttonholes and air tucking).
4. over pin 4,
5. between tension discs 5, from right to left,
6. while holding thread spool, pull thread upwards into the loop of take-up spring 7
7. until it enters retaining fork 6
8. up and from right to left through eye in take-up lever 8,
9. down through thread guide 9,
10. further down, in front of guide 10 and through guide 11, into guide 12 on the needle clamp,
11. and finally from front to back through eye of needle, 13.

Bobbin winding, foot operated, (Fig. 8): On treadle operated machines equipped with a bobbin winder, illustrated in figure 8, release machine pulley, by holding same with left hand, and with right hand loosen stop motion screw, turning it counterclockwise. The thread spool is then placed on the nearest of the twin spool holders. Guide thread through hole 1, over bobbin tension 2, and down to the bobbin 3, on the winding spindle. Wind thread a few times around by hand.

Press latch 4 against bobbin. You are now ready to watch the winding operation which is done uniformly and automatically by the machine, no further steps being required. The bobbin winder will stop automatically when the bobbin is filled. When the operation is completed, re-tighten the stop motion screw on the machine pulley. Bobbins may be wound while machine is stitching, if so desired. In this case, it is not necessary to release the stop mechanism.

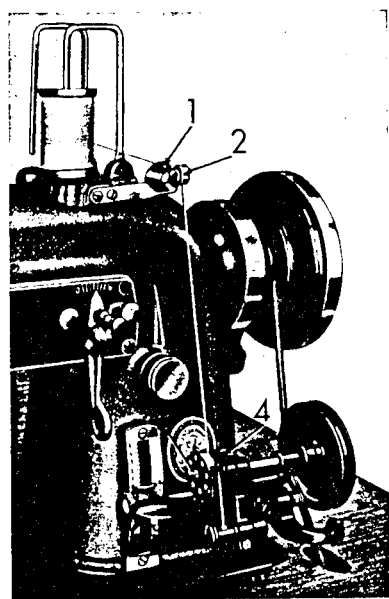

Fig. 8 Bobbin winding, treadle operated --

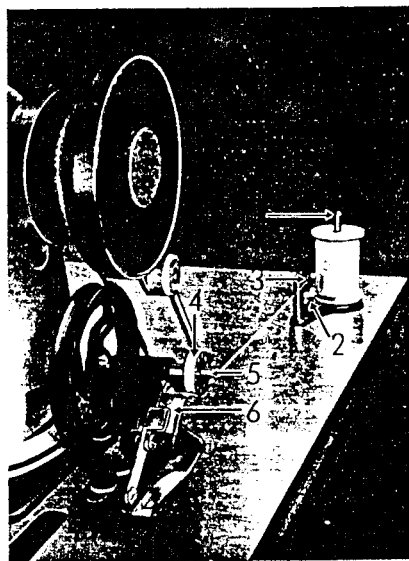

Fig. 9 Bobbin winding on electric machine

Bobbin winding on electric machine (Fig. 9): On electrically driven machines, where the bobbin winder, as illustrated in figure 9, has the spool holding pin affixed to the table top, the thread spool is placed on pin 1. Run thread through guide hook 2 from below, up and between the tension discs 3 of the spool holder, and from there on to bobbin 4 which has been placed on winding spindle 5. Press latch 6 down toward bobbin. Release machine pulley as previously instructed. As soon as the bobbin is filled, the winder will stop automatically. If the machine is equipped with thread stand D as shown in figure 6, guide thread from upper holding arm directly under guide hook 2 and from there follow the same steps as described above. When bobbin is wound, retighten stop motion screw on machine pulley. Bobbins may be wound while machine is stitching, if so desired. In this case, it is not necessary to release the stop motion mechanism.

Threading and replacing of bobbin case: Fig. 10 illustrates the replacing of bobbin into the bobbin case. Your attention is called to the thread, which, as shown, must run from right to left, over the top of the bobbin. Guide thread through the slot in bobbin case, then under the tension spring 1, as shown in fig. 11. Hold bobbin case in right hand, and as shown in fig. 12, grasp thread

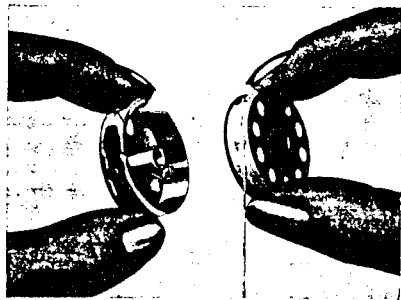

Fig. 10 Placing of bobbin into case

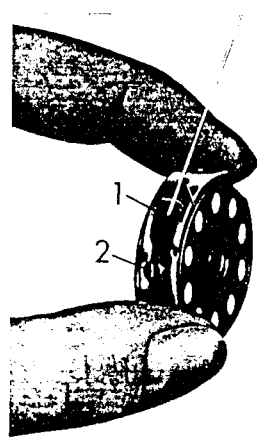

Fig. 11 Threading through tension spring

with right thumb and guide it through slot 2 and immediately following through slot 3 of the bobbin case so that the thread runs as shown in fig. 13.

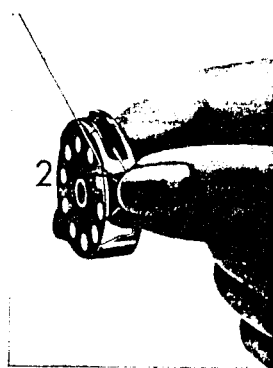

Fig. 12 Threading of bobbin case

On the model 307 G, the bobbin case is inserted from the rear. Grasp the fully threaded bobbin case between thumb and fore-finger of left hand at latch hinge point as shown in Fig. 13, making sure thread runs backward. Insert bobbin case from the rear so that it engages the post. Release the latch and press the bobbin case until it snaps into place.

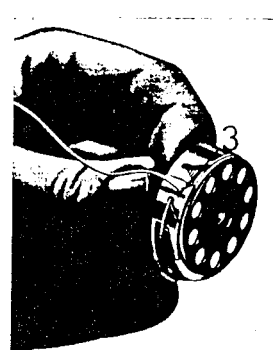

Fig. 13 Bobbin case correctly threaded

Obtain your supplies of sewing thread and silks from your nearest Singer store.
SINGER THREADS ARE QUALITY THREADS.

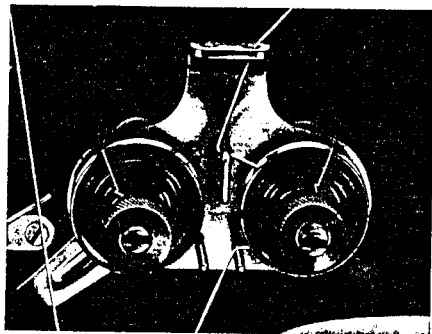

Fig. 14 Thread tensions

Thread tensions (Fig. 14): In order to permit versatility and rapid changes to different sewing operations, the machine is equipped with two different thread tensions for the upper thread:

1. The thread tension at the right for all normal sewing operations.

2. The buttonhole tension at the left which is also used for air tucking.

For perfect stitching, the tension on the needle and bobbin threads must be heavy enough to pull threads to center of material and make a firm stitch as shown in Fig. 15.



Fig. 15 Perfect straight stitching

In the unbalanced tensions in Fig. 16 the needle thread lies straight along the top side of the material, caused by too heavy tension on needle thread or too light tension on bobbin thread.

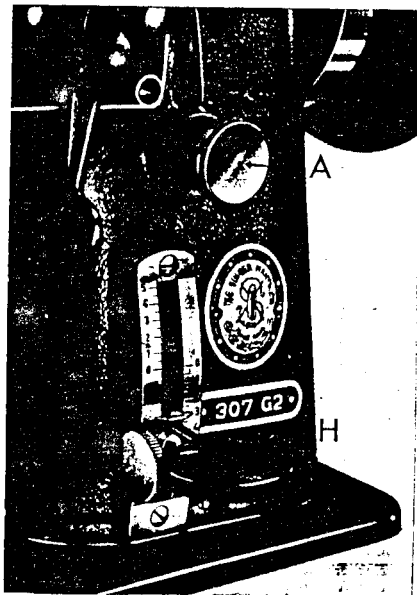

Fig. 16 Imperfect straight stitching

In the unbalanced tension shown in Fig. 17, the bobbin thread lies straight along the under side of material, caused by too light tension on needle thread or too heavy tension on bobbin thread.



Fig. 17 Imperfect straight stitching



The needle thread tension is obtained by turning the thumb nut K Fig. 14 in front of the tension discs. The tension on bobbin thread is regulated by screw 2 Fig. 11 on the tension spring on the outside of the bobbin case.

In both tension adjustments, a gradual turn to the right increases tension, while a turn to left decreases tension.

In most instances, adjusting the needle thread tension alone will provide a satisfactory stitch. The various required tensions for such special operations as bar tacking, felling, buttonhole sewing, etc. are fully described in the respective covering instructions throughout this booklet.

Length of stitch: To regulate length of stitch, adjustments are made by means of the stitch of lever H Fig. 18 in conjunction with stop screw A. Numbers on the stitch regulator scale S designate stitch length from 0 to 5 millimeters.

Fig. 18 Stitch lever with stop screw, scale and set screw

The stitch lever H is pushed upward by means of a spring tension. When in this position, the machine will stitch forward at the set stitch length. Setting to any desired stitch length may be accomplished by turning limit screw A. To shorten stitch, turn screw A clockwise. To lengthen, turn counterclockwise.

Reverse stitch: When stitch lever H is pushed all the way down, the machine will at the same stitch length, stitch backward. Should you desire to secure a seam at its end, to prevent it from unraveling, a short downward motion with stitch lever H will cause machine to make several stitches backward and forward, thus locking the seam.

During felling, long reverse stitching may be required, and in order to have both hands free, you will find switch lever U (Fig. 19) on the back of the

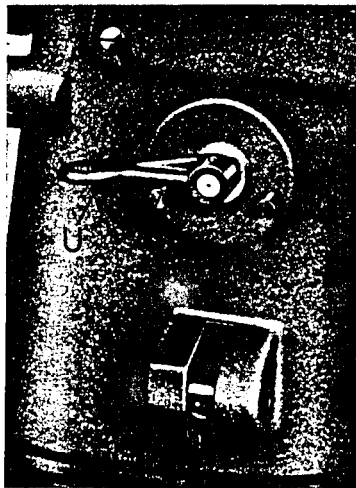

Fig. 19 Switch lever to release stitch lever tension spring

machine, which may be turned to the right as indicated by arrow.

This releases the stitch lever tension spring, which normally keeps the stitch lever up. With the spring tension thus released, you may now place the stitch lever in any desired position, fixing it by tightening set screw F Fig. 18. As soon as normal stitching is resumed, loosen set screw F Fig. 18 and move switch lever U Fig. 19 back to left.

Bight control: Settings are made as described in the following chapters, by means of levers A and B in Fig. 20.

For straight or zig-zag stitching, the bight control lever A is set accordingly, while needle position lever B provides any one of the three needle positions, left, center or right.

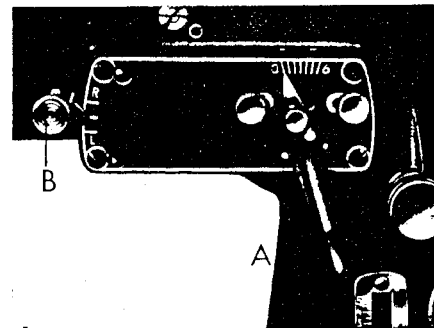
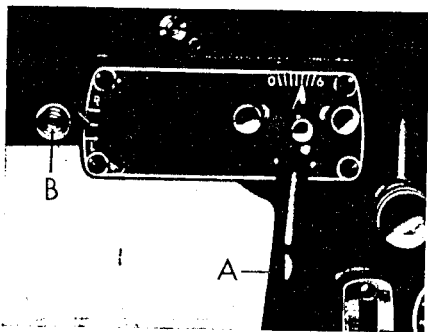

Fig. 20 Setting for straight stitching

Straight stitching: The positioning of bight control lever A at 0, as shown in Fig. 20, will provide a straight stitch. Needle position lever B is normally placed in its central position, as shown in Fig. 20.

Zig-Zag stitching: When bight control A is moved away from 0 to another position on the scale, as in Fig. 21, the machine will perform zig-zag-stitching. Each scale division is equivalent to one millimeter bight width, i. e. it is possible to zig-zag stitch up to six millimeters in width.

Central needle Position: For normal sewing, needle position lever is set at the middle of scale as shown in Fig. 21. The needle then swings equally to the left and right of center.



← Fig. 21
Setting for zig-zag stitch

As shown in Fig. 22, the portion A to C was sewn with central needle position. Portion A to B represents the straight seam in the middle, B to C zig-zag stitches of varying width, up to six millimeters maximum.

Fig. 22 →
Stitches with needle in the three different positions

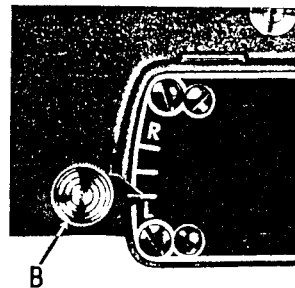
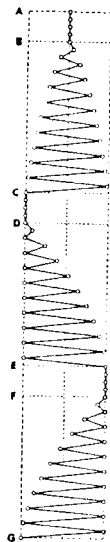

← Fig. 23 Left needle position setting

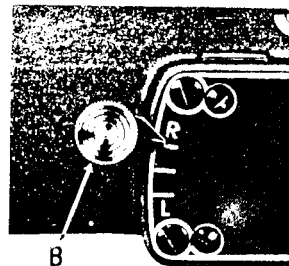

→ Fig. 24 Right needle position setting →

Left needle position: When needle position lever B is set all the way down, opposite L on the scale Fig. 23 after pushing its release button, the machine sews at the extreme left for straight stitching, portion C to D in Fig. 22, and as the bight control is changed from 0 to 6 the needle swings from the

extreme left, in zig-zag towards right, D to E in Fig. 22.

Left needle position is used while blind stitching, sewing buttonholes, sewing on buttons, hooks, eyelets as well as in felling operations.

Right needle position: When lever B is set all the way up, opposite R on the scale Fig. 24 the machine sews at the extreme right for straight stitching, E to F in Fig. 22 and as the bight control is changed from 0 to 6 the needle swings from extreme right, in zig-zag stitch towards left, F to G in Fig. 22.

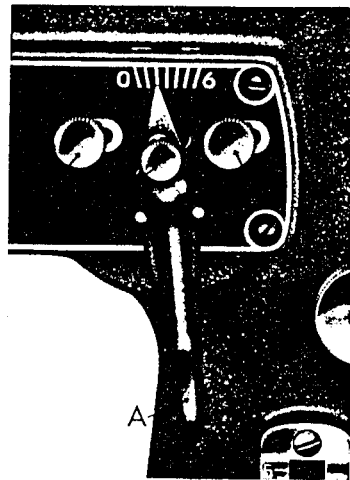

Fig. 25 Bight control lever stop screws

If, during buttonhole sewing, it is desired to limit the width of bight, simply loosen set screws C and D, Fig. 25.

Bight control lever stop screw (Fig. 25): Bight control A, as well as needle position lever B, may undergo position changes while stitching is in progress. Changes may be made, for instance, from straight stitching to zig-zag stitching, as well as changes from one width of bight to another.

Sliding the screws sideways, set for desired width of bight and retighten after setting. A quarter turn of thumb screw K, Fig. 25 will however release the set screw settings, and the bight lever will again range over its entire scale. If thumb screw K is given another quarter turn, the bight lever is promptly limited once more by the set screws.

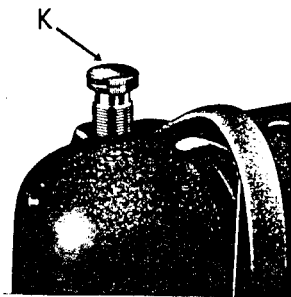

Fig. 26 Pressure regulating thumb screw

Presser Foot Pressure: Under average conditions, the pressure on the presser foot need not be

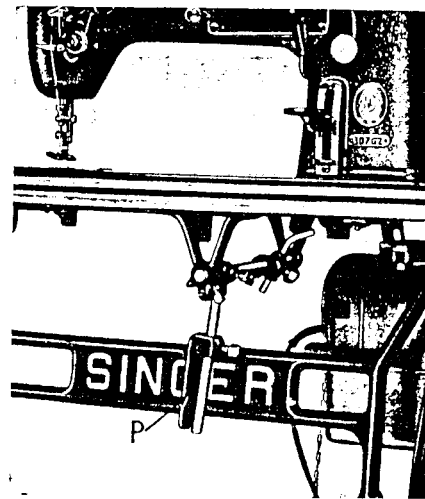

Fig. 27 The knee lifter lever

changed. With exceptionally thick and resilient fabrics the pressure may require to be increased. To do this, turn regulating thumb screw K, Fig. 26 down, into machine. To decrease pressure, turn screw upwards. Pressure should be adjusted so that the feed dog can move the fabric smoothly and uniformly, without the needle pulling the fabric up. Too heavy pressure will cause machine to labor.

Knee lift (Fig. 27): In order to lift the presser foot at the start or end of a seam, the machine is fitted with a knee lift device, built into the machine arm, of which only the lower part, under the table top is visible. By exerting pressure against the lever P, Fig. 27 with the right knee, the presser foot will lift up, thus leaving both hands free to handle the fabric.

II. Lubrication and cleaning

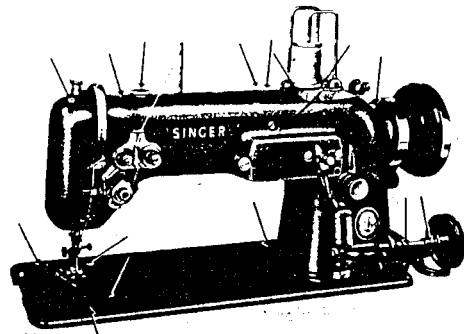

Fig. 28 Oiling points, front side

Oiling (Figs. 28 to 32): A zig-zag stitching machine has a greater number of moving parts and bearings than a regular sewing machine. Thus the number of oiling points is greater. It is important that the machine, when in continuous daily use, be lubricated frequently.

This will avoid noisy running at the same time assuring long life. In Figs. 28 to 32 all oiling points are marked by arrows. For the less accessible parts of the machine, specific lubricating instructions are contained herein. For the lubrication of the needle bar and surrounding moving parts Fig. 30, remove the face plate by loosening thumb screws 9 and 13, Fig. 1.

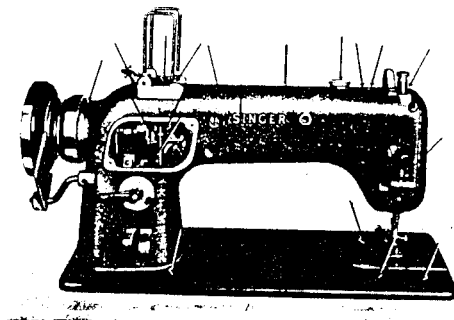
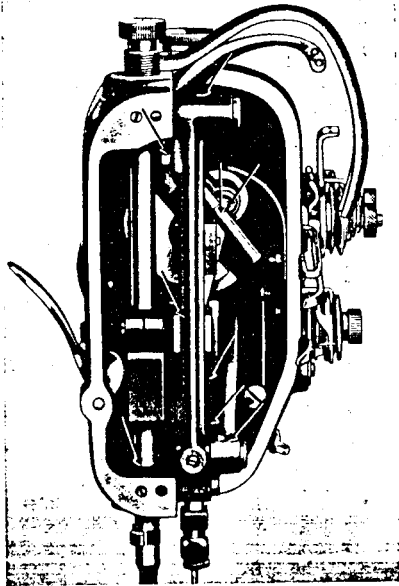

Fig. 29 Oiling points, rear side

The oiling points at the rear of the machine are shown in Fig. 29. Here, the arm side plate is to be removed (by removing both screws) so that the cam which transfers the bight movement over to the connecting fork may be oiled.

To reach those bearings not readily accessible through oiling points in the bed plate, the machine is to be tilted backwards. The points to be thus oiled are shown in Fig. 31.



It is particularly important to oil **daily** the sewing hook race. For this purpose the back of the hook is fitted with an oil-felt plug (shown in Fig. 32 at F) which must be oiled every day with one or two oil drops.

Cleaning: After each oiling, the machine should be wiped clean with a soft cloth. Feed dog and hook should also be frequently cleaned of all lint, dust, etc. The feed dog may be cleaned only after removal of the throat plate. At periodic intervals, or after the machine has been idle for a long time, a general cleaning should be performed. Drop generous amounts of cleaning paraffin into all oiling holes, then let machine run rapidly for some length of time. This will dissolve and flush out all old dirt and caked oil remnants.

← Fig. 30 Oiling points behind the face plate

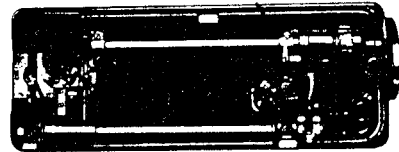

Fig. 31 Oiling points beneath the bed plate

After machine has been thoroughly cleaned, lubricate with fresh oil immediately. For proper lubrication, only recommended oils should be used. Oil of improper composition may have reduced lubricating effects. Such oils thicken and become gummy, causing the machine to labor and run with difficulty.

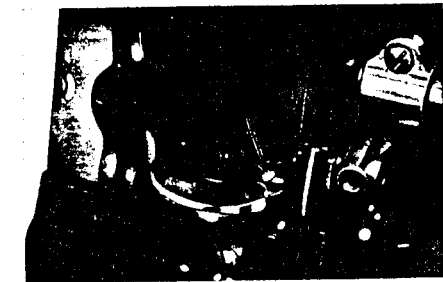

Fig. 32 Oiling of the hook

Glycerine should be avoided as lubricant. Although it does have lubricating properties, it also attracts moisture, causing rust formation on the oiled parts. The properly recommended grade of sewing machine oil is always available at all Singer Shops.

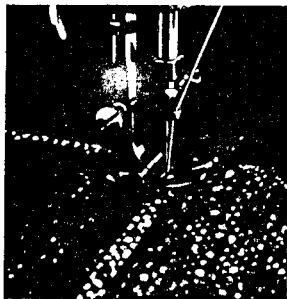

Fig. 33
The hinged presser foot crossing seams

III. Sewing with a straight stitch (Hinged presser foot)

Hinged presser foot: For most sewing operations, and especially for plain seams, the Hinged Presser Foot 1, Fig. 2 should be used.

Plain Seams: Normal stitching is performed with central needle position (see Fig. 20 for needle position and bight lever control settings) and by using the thread tension as shown in Fig. 14.

Seam crossings (Fig. 33): When sewing across other seams, coat hems etc., the hinged presser foot adapts itself to the changing fabric thickness, avoiding miss stitching and bunching of the material.

Use of the edge guide: When stitching hems in heavy fabrics, such as winter coats or suits, with the hinged presser foot, use of the edge guide 3, Fig. 2 will facilitate the guiding of the material. It is fastened to the bed by means of the tightening thumb screw 4, Fig. 2.

IV. Straight stitching (Presser foot with guides Fig. 2, No. 2, a to f)

The presser foot with guide 3, Fig. 2 is recommended for all straight stitching when seams are to run parallel at certain widths, or parallel to an edge. For stitching at very narrow widths, use extension (a), for broader widths use guides b to f.

The guide may be clamped behind the leaf spring, after raising lever 1, Fig. 34. The desired seam distance from the edge or from the next seam can be set easily through the scale etched on the guide. For parallel seams, a guide with a shallow edge should be used.

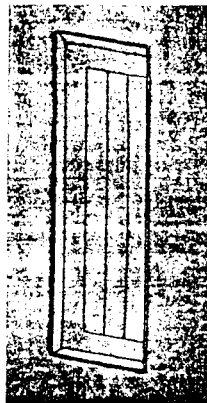

Fig. 35
Sport coat pocket flaps with top stitch decoration

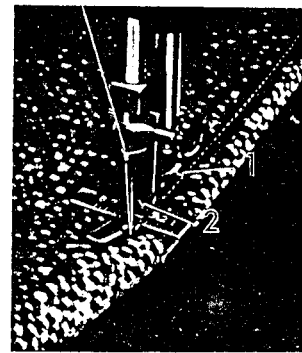

Fig. 34
Top stitching with presser foot and guide

Top stitching (Fig. 34): For top stitching of corners, pocket flaps, collars, belts, sleeve hems, jacket hems, etc., use a right-hand guide with a deep edge of appropriate length (unless due to the narrow edge, the accessory B becomes necessary).

Top stitching pocket flaps (Fig. 35). Here too, the presser foot with guides is suitable. In most instances a guide with a deep edge is indicated. Only thin fabrics require the use of the shallow edge.

Flat felled seam (Fig. 36): All side seams, sleeve, back and shoulder seams finished as flat felled seams can be made accurately with aid of this presser



Fig. 36 Flat felled seam

foot since both the first and second seams can be made with a guide. The choice will be governed in the same manner as in the case of the pocket flap.

For the second seam it may be convenient to use a left hand guide.

The left hand guide may also be used for the insertion of sleeves with flat felled seams.

Top stitching on sport coat hems (Fig. 37). On all top stitch seams the presser foot, in combination with a right hand guide, shallow edge, is to be used.

Quilting (Fig. 38): Presser foot when fitted with a long guide 2 f Fig. 2, is especially ideal for excellent quilting work.

30

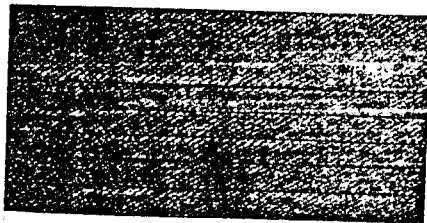

Fig. 37 Top stitching on coat hem

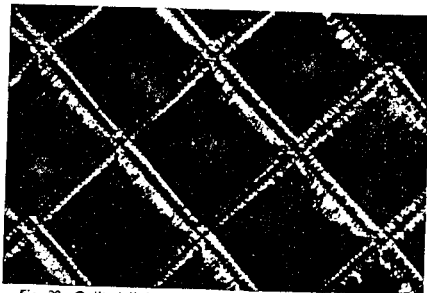

Fig. 38 Quilted lining made with the guide presser foot

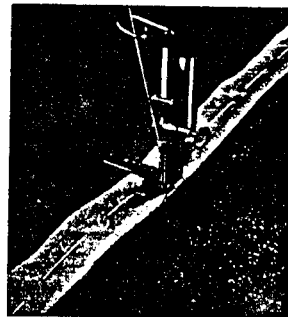

Fig. 39 Sewing on piping

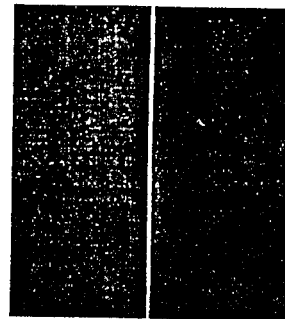

Fig. 40 Finished piping on uniforms, work clothes, etc.

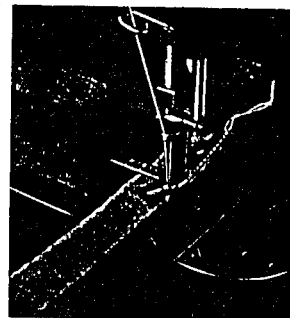

Fig. 41 Sewing on piping trim to an uniform trouser

Piping (Figs. 34—40): After pressing in the trouser crease, use a right hand guide with a deep edge, and with white bobbin thread sew on the piping. With a basting stitch, sew on the other half of the trouser leg, and, following the line of the white bobbin thread on the first seam, join the two halves of the trouser leg together. This presser foot will assure an accurate piping job, the width of which can be set exactly beforehand with a guide.

Piped trim on uniforms (Figs. 41—42). When sewing piping onto uniforms, this presser foot is to be used on both seams. When sewing on the piping, the guide with shallow edge assures constant width control between seam and trim edge. When making the second seam, i. e. top stitching the piping, it is advisable to use a guide with deep edge. In both instances the guides permit correct stitching in corners and curves.

31

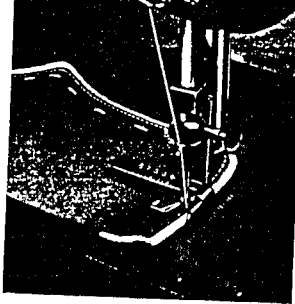

Fig. 42 Top stitching a piped edge

V. Sewing with a straight stitch (Right hand zipper and cording foot)

Sewing in zippers (Fig. 43):

The slit seam is basted together, then folded apart and pressed. The zipper is then basted on to the left side in such a position that the center of the zipper faces exactly the center line of the basted seam. The zipper is then sewn on closely to both sides, using the right hand zipper and cording foot 5, Fig. 3.

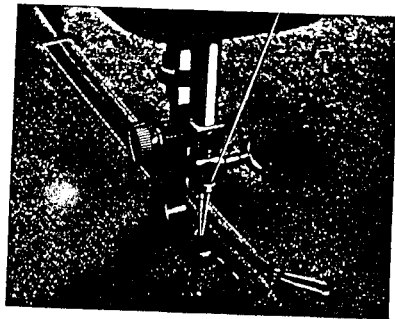

Fig. 43 Sewing in of a zipper →

If it is more practical not to turn the fabric around for the stitching on the opposite side, that seam can be sewn by using the left hand zipper and cording foot 6, Fig. 3.

VI. Overedging with a hinged presser foot (zig-zag stitching)

Needle position: All sewing operations described in this chapter are performed with the central needle position (lever B in center position as shown in Fig. 21).

Basting with zig-zag stitch (Fig. 44): When basting side seams of jackets and winter coats for fitting purposes, the machine basting with a zig-zag stitch is equivalent to hand basting, for it, too, joins two pieces of fabric lying flat on top of each other. Length of stitch and stitch width are governed by fabric thickness. Using a size 18 needle, pass the thread through thread tension as shown in Fig. 14. Both upper and lower threads should be the same size, as used in hand basting. Use light upper thread tension, to permit easy removal of basting stitches at the required time.

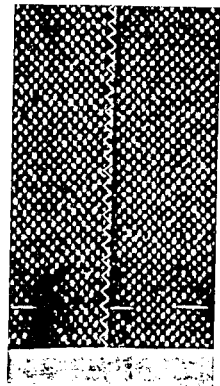

Fig. 44
Side seam

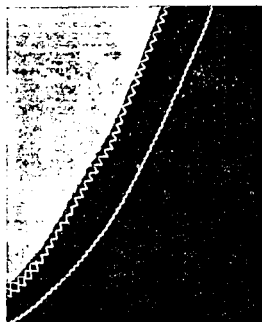

Fig. 45 Trouser seat seam



Fig. 47 Collar sewn on by zig-zag stitch

Trouser set seam (Fig. 45): In making the seat seam, a short zig-zag stitch may be used. This will accomplish sufficient elasticity of this particularly demanding seam without adding the usual second line of stitching.

Felling interfacing to outer garment (Fig. 46): Using a Zig-Zag stitch for felling the interfacing to the outer garment can be accomplished by a single seam instead of four lines of straight stitching, with the advantage that the edges are evenly joined. Set bight control lever at 5 millimeters, and stitch length at one to two millimeters. The thread used here will be the same as used in the subsequent operation of overcasting the interfacing or lining Fig. 67.

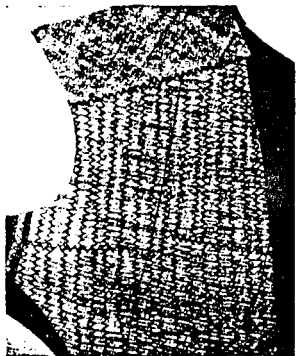

Fig. 46 Felling interfacing to outer garment

Sewing on a collar (Fig. 47): The sewing on of the undercollar to the garment is done by setting bight control at 2—3 millimeters and stitch length at 1—2 millimeters, using silk thread.

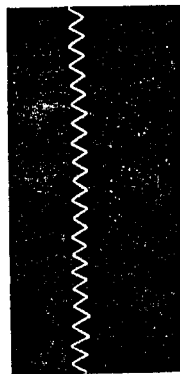

Fig. 48 Joining abutted edges

Joining abutted edges (Fig. 48): Butt joining of edges is rapidly performed with the zig-zag stitch. The possibilities are numerous. Just to mention a few: joining under-collar pieces, trimmings, belts of coats and jackets, sleeves and sleeve cuffs on coats, uniforms, etc.

Applique of emblems (Fig. 49): In this type of work, a very narrow bight is recommended and, of course, silk thread which matches the emblem.

VII. Overedging of seams

Presser foot: Use the presser foot for overedge stitching, 4 Fig. 3, either with or without the edge guide 3, Fig. 2.

Needle position: Lever B in central position as shown in Fig. 21.

Procedure (Fig. 50): Set the bight at 5 millimeters. Be sure that equally light upper and lower thread tensions are maintained to avoid raveling the edges. The greater the tendency of the material to pull threads, the shorter the stitch length the safer the seam.



Fig. 49 Applique of an emblem

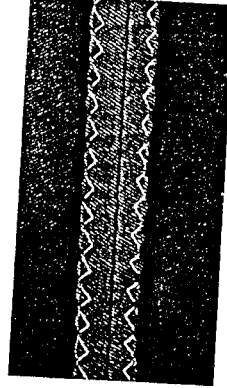

← Fig. 50
Overedging trouser seams

VIII. Bar tacking

Tacking foot 1 Fig. 3 is used for this operation, its sole being fitted with a groove to admit the raised height of the bar tack.

Setting for bar tacking: Central needle position Fig. 21 and a bight of 2—2½ millimeters. Stitch length should be sufficient to allow bight to go through interfacing, while permitting feed mobility. Use silk thread with tight thread tensions; a stitch length of ½ millimeter should be adequate. Choose needle size 16 or 18.

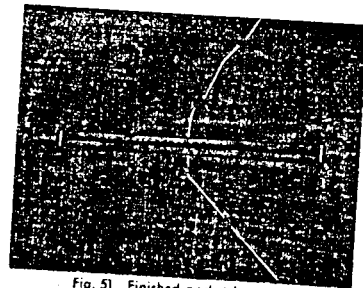

Fig. 51 Finished pocket bar tack

Sewing of bar tack (Figs. 51—52): First, straight stitch forward and back two or three times along the length of the desired bar tack. Gimp thread applied with a gimp needle, can be used as reinforcement for bar tacking, passing the thread through the wrong side and tying the ends together.

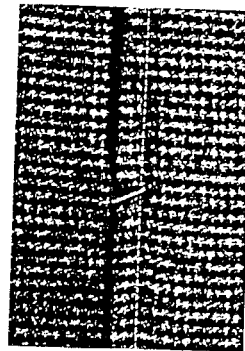

Fig. 52 Bar Tacking

It is recommended that at the start and finish of the bar tack, several stationary stitches be made with an 0 position of the bight control, to knot the start and end threads together and, at the same time, to tie in the gimp.

IX. Sewing on buttons

Procedure (Fig. 53): Attach button sew-on foot 2, Fig. 3 and use strong upper and lower thread (No. 40 or silk thread). Set bight for the distance between centers of the holes in the buttons, usually 4 millimeters, and the stitch length lever at 0 to make stationary stitch (see Fig. 18). Needle position control B, as in Fig. 23, is set for left needle swing. Drop needle through center of left hole. Then lower button sewing foot. Turn hand wheel over toward yourself until needle rises and commence stitching. Needle should enter each hole about six times. To fasten stitch, set bight at 0 and take three stitches in left hole of button.

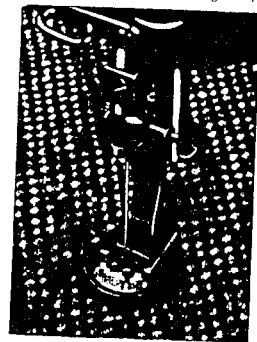

Fig. 53 Sewing on button

Button Sewing (Figs. 53 and 54): Suitable for most button sewing operations such as on suits, coats, jackets, uniforms, etc. Buttons may be sewn on with either cross or parallel stitch.

To sew on buttons with thread shank (Fig. 55): Follow steps as outlined above but hold either a pin, needle or thin wooden match between button and fabric, between holes, to deepen stitches and provide thread

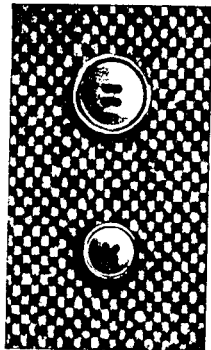

Fig. 54 Four-holed buttons.

shank. Finish shank by twisting thread around it for a few turns by hand. Snaps, hooks, eyelets etc. are sewn on in a similar fashion. At the end of each stitching, do not fail to fasten stitch by setting bight at 0.

X. Blind stitching

Blind Stitch foot: Use the blind stitch foot 8, Fig. 3 which has a spring guide. The blind stitch foot can be set for style and thickness of fabric, as well as stitch length by making an adjustment with the thumb screw on the guide.



Fig. 55 Sewing on button with thread shank

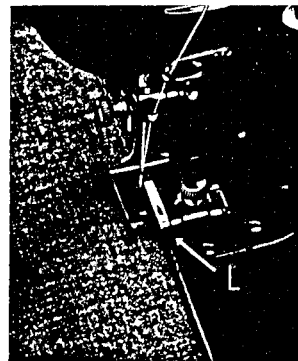

Fig. 56 Position of material in blind stitching

In most cases, the bight should be approximately 4 millimeters, with suiting less than 4 millimeters, and with heavy, easy-to-fray fabrics 5 millimeters. Accuracy of stitching is achieved by using a thin needle (size 14). Tensions are to be loose and silk thread is recommended for blind stitching. The various required stitch lengths are described in the following paragraphs.

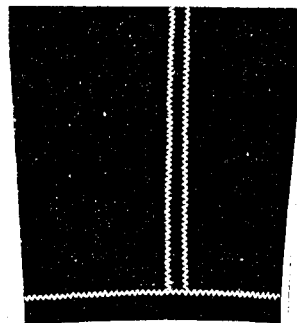

Fig. 57 Overcasting trouser cuffs

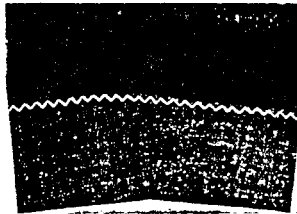

Fig. 58 Inner sleeve cuffing

Needle position: For all operations with the blind stitch foot, left needle position Fig. 23 is required.

Settings for blind stitching (Fig. 56): Fabric is lined up under the blind stitch foot as shown in Fig. 56.

Gauge L, Fig. 56 is to be set so that needle in its left stitch does not go through the fabric all the way, only deep enough for the stitches to take a good hold. The right stitch must be outside the underfold.

Overcasting trouser cuffs (Fig. 57): Blind stitching of cuffs on trouser bottoms as well as trouser seams is performed as shown in Fig. 56. The recommended stitch length in each case is 2 to 3 millimeters.

Sleeve cuffing (Fig. 58): Here, the inner lining often represents the upper, folded material. Stitch length 4 to 5 millimeters.

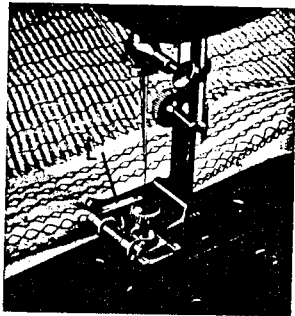

Fig. 59 Stitching the twill tape

Blind Stitching of twill tape (Figs. 59 and 60): Twill tape, when blind stitched to either an outer or an inner edge is always the lower sewing material Fig. 59. As usual, it is basted on before blind stitching. Stitch length should be 2 millimeters for outer edging, somewhat longer for inner edging. A finished operation is shown on Fig. 60. While stitching around a corner, needle is left inside fabric while turning the twill tape.

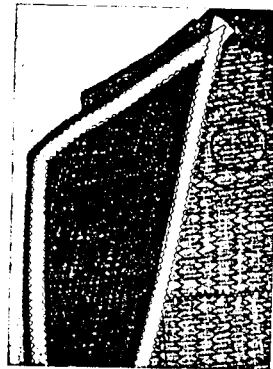
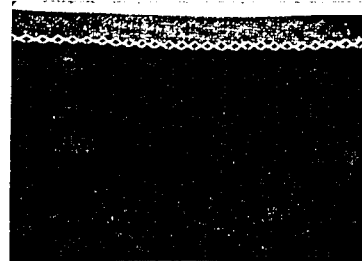

Fig. 60 Twill tape, finished

Attaching the upper collar (Figs. 61 to 63): The procedure used in attaching the collar is the same as previously described. The lower material here is the bent-over edge of the upper collar, while the lower collar is stitched on from above, Fig. 61. In this procedure (No. 1) the upper collar, before being blind stitched on, is basted on first. Thus the blind stitching becomes the final operation.



← Fig. 61
Collar attached
after procedure No. 1

Fig. 63 Collar finished and attached,
procedure No. 2



Fig. 62 →
Collar sewn on after
procedure No. 2

Another procedure (No. 2) for attaching the collar is seen in Figs. 62 and 63. The lower collar is stitched on to the edge of the upper collar (both right sides up) using the hinged presser foot and small zig-zag stitches. After being securely sewn on, the upper collar is turned around and blind stitched to the garment.

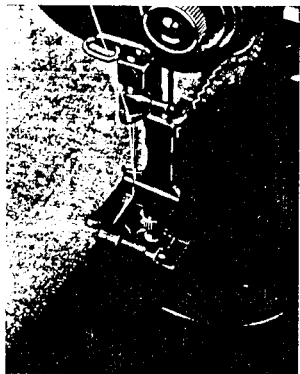

Fig. 64
Blind stitching of sleeve inner lining

Sleeve Inner Lining (Figs. 64 and 65): To blind stitch the inner sleeve lining to the sleeve cuff, bend over the upper material and guide along the blind stitch foot while the inner lining which is shown in Fig. 64 extends $1\frac{1}{2}$ to 2 centimeters, is positioned under the guide. The outer garment fabric is thus blind stitched to the inner lining.

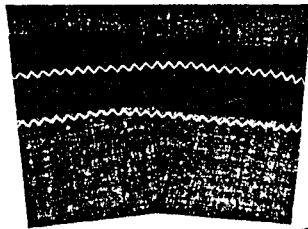
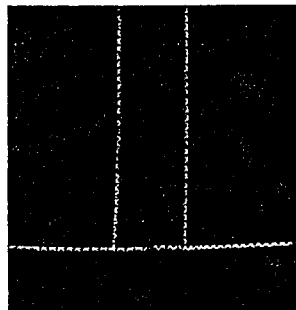

Fig. 65 Inner sleeve lining



Coat Hems (Fig. 66): For blind stitching of hems and seams on ladies coats and skirts the procedure is the same as described for trouser hems, except the bight should be set at 5 millimeters and a long stitch length should be used.

Fig. 66 Coat hem —

XI. Zig-Zag Stitching of the interfacing

Zig-Zag stitching the placket: This procedure is a great time saver and very simple when performed by machine instead of by hand.

Settings for stitching the placket to the interfacing: Use hinged presser foot 1, Fig. 2, stitch length 5 millimeters and bight control at 6 millimeters. Stitching is done with a soft, thin thread so that the stitches blend with the fabric.

Procedure when zig-zag stitching the placket (Figs. 67 and 68): Follow as shown in Fig. 46 and if desired, baste on placket to interfacing. The placket may be attached to either the inner or outer side of the interfacing, which should then be placed under the presser foot as shown in Fig. 67. Regardless of whether the placket is attached to the outer or, as in Fig. 68, the inner side of the interfacing, it is the inner interfacing side that must face up to achieve the correct curving of the material.

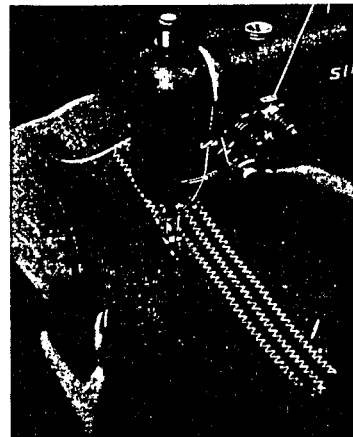

Fig. 67 How to guide the interfacing

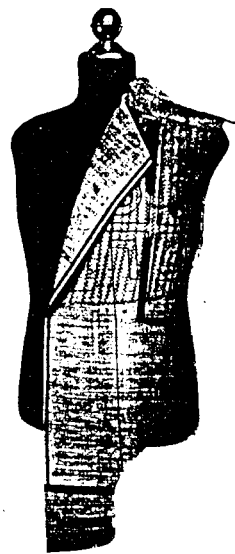

Fig. 68 Finished interfacing

As if doing it manually, the zig-zag stitching is done from the center of the placket outwards, stitching the length of the material first one side, then the other, by zig-zag stitching equally spaced, and which, to save time, can be sewn continuously. At the end of each seam, the material is turned around, and stitching is continued in the other direction. When finished, it is recommended to sew down the edges of the placket with a wide zig-zag stitch. This should be done from the side to which the placket is attached. Fig. 68 shows a finished interfacing job.

XII. Felling of lapels and collars (blind stitching)

Felling Attachment: To perform blind felling on lapels and collars, use the Felling Attachment, Fig. 5, consisting of a felling guide and automatic felling foot.

Needle and Needle Position: To work with this attachment, needle size 14 is recommended, as well as left needle position, Fig. 23. For thick fabrics use a correspondingly heavier needle; for thin fabrics, a size 11 needle.

To Change Position of the Needle Clamp (Fig. 69): Before starting blind felling, the needle clamp must have its position brought forward 45 degrees. Remove needle, loosen the pin and carefully remove needle clamp from needle bar. Replace clamp, with the needle-tightening thumb screw, Fig. 69 moved 45 degrees forward as shown. At this point the needle bar key must fit into the adjoining keyway. Then retighten pin. Replace needle, properly selected for blind felling, taking care to insert same with the long groove towards yourself.

Attaching the Felling Accessory (Fig. 70): After removing the slide plate, bend hinged upper part of felling attachment backwards, and set

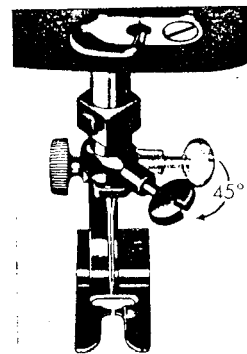
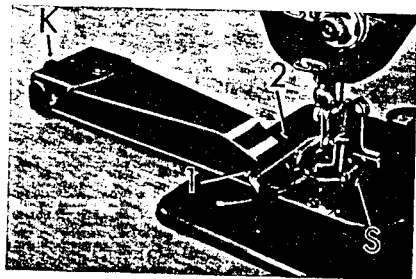

Fig. 69 Changing position of needle clamp

it into slit of throat plate. Secure with screws 1 and 2, under slight side pressure. To remove accessory simply loosen screws 1 and 2.

Setting the felling attachment (Figs. 70 and 71): The attachment and removal of the accessory is accomplished very simply and rapidly, and any changes in the basic setting of the felling accessory in relation to the needle are simple. The basic setting, determined by the thickness of lapel fabric, is that the needle blade should fit about one third of its diameter into the needle groove in the tip of the attachment. Fig. 71. The **needle point** in this setting is **close to the outer edge** of the attachment. This setting is accomplished by turning set screw K, Fig. 70, after releasing locking screw. For thick coat lapels, the



← Fig. 70
Attaching the
Felling Accessory

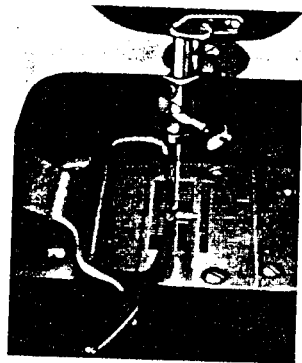
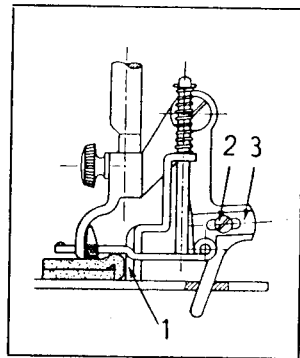

Fig. 71 →
Position of felling
guide in relation
to needle

set screw is turned back sufficiently to bring the **needle blade** close to the outer edge. In any case, the depth of bight should be sufficient to ensure that the needle gets a good hold on the outer garment.

Slight adjustments of the bight can be accomplished without changing the felling accessory setting, by minor manipulation of the needle position control for left needle swing, unless the bight setting is at its maximum.

The automatic felling foot (Figs. 70 and 72): When screwing in the automatic felling foot, sink its rudder lever S, Fig. 70 into the guide hole in the throat plate. The designation "automatic" refers to the ability of the felling foot to lift itself above the fabric during the feeding, permitting a free passage for all material.



The felling foot pressure plate 1, Fig. 72 should exert light pressure against the fabric every time the feed dog is under the throat plate. To accomplish this, loosen screw 2 and move sliding piece 3 together with the pressure plate 1 lightly against the fabric. Retighten screw 2. For each setting change of the felling accessory, the foot pressure plate must be readjusted as described above.

Thread. Since felling stitches should be almost invisible after pressing, use soft, fine upper thread. Silk thread may be used if desired.

← Fig. 72 Setting the felling foot pressure plate

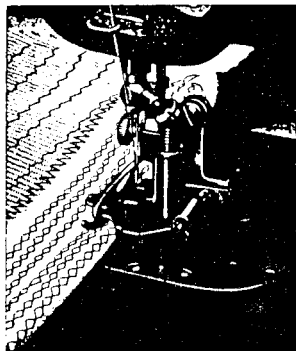

Fig. 73 Blind felling of a coat lapel

Tensions. Both tensions must be quite light. Correct tension is necessary for uniformity of stitch penetration.

Procedure with coat lapels (Figs. 73 and 74): As in manual felling, machine felling starts from the lapel break outwards. The left lapel is started from the top, the right one from the bottom, so that the first seam is forward. As shown in Fig. 73, place lapel under felling attachment and with bight set at 3 to 4 millimeters, stitch length at 2 to 3 millimeters, proceed with the felling stitches parallel to the lapel break. To save time use forward and reverse stitching but note, that it will be necessary to release the stitch lever tension spring, as described in detail on pages 18 and 19 and as illustrated in Fig. 19. After each run of felling, move the fabric on the upper lapel edge a bit further. However, if not too much emphasis is placed on appearance, continuous forward and reverse stitching can be made.

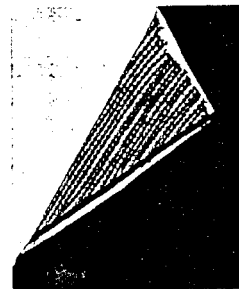

Fig. 74 Coat Lapel

The degree of roll is determined by the distance between the felling seams as well as thread tensions. Seams sewn close together with a tighter tension makes for a stronger roll. With light weight interfacing materials close stitching may adversely affect the pliability of the lapel.

For blind felling of lapels on heavy winter coats and other thick fabrics, the felling accessory must be set back, as described above, and the felling foot pressure plate adjusted accordingly. Fabric thickness determines settings for bight and stitch length, which should be set relatively high (about 4 to 5 millimeters).

Thread tension should be very slack. With extremely thick fabrics it may be preferable to use only a forward stitch.

Under collar (Fig. 75): Blind felling of under collars is done in the same manner as lapels, and with the identical settings. As usual, stitching starts from collar break outwards.



← Fig. 75 Under Collar

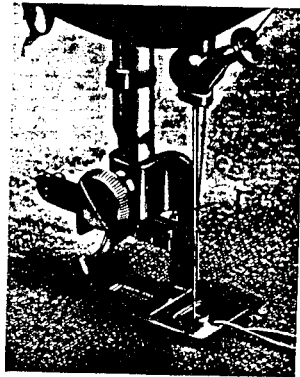

Fig. 76 Buttonhole Foot

XIII. Buttonhole sewing

Buttonhole Foot 3, Fig. 3, is fastened to the machine like any presser foot Fig. 76. The adjustable indicator Z on the gauge L behind the foot is used to set the buttonhole length and is also a guide for recalling previously used settings. This indicator must be set before sewing to the desired buttonhole length on the centimeter scale of the gauge. At the forward tip of the foot an eyelet for gimp thread has been provided.

Needle position: Should be left sewing for all buttonhole sewing.
Thread: The same thread as used for hand buttonhole sewing may be used. Buttonhole silk or gimp silk for the bobbin thread, and thread No. 40 for gimp buttonholes, as upper thread.

Tension and Threading (Fig. 77): A very tight upper thread tension is required (hence thread No. 40).

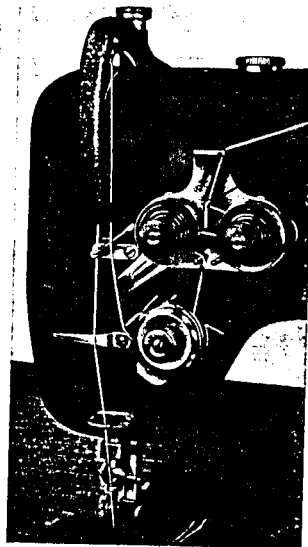

Fig. 77 Threading for buttonhole sewing

As shown Fig. 77, guide thread through both sewing and buttonhole tension. First thread the right (sewing) tension. Then guide the thread from above, around buttonhole tension and around pin 2. It is important that the thread is guided around pins 1 and 2 as shown in Fig. 77.

Bobbin thread tension should be slack, to allow the pulling up of the bobbin thread, necessary in the formation of raised or gimp buttonholes.

Stitch settings: Bight control at $2\frac{1}{2}$ mm. Stitch length to be set for very close stitches, although continuous smooth feeding must be maintained. Until the operator has acquired enough practice it is recommended to test each buttonhole on a trial basis with a piece of surplus fabric. This will save unnecessary slitting work.

Procedure: Mark position and length of buttonholes with marking chalk and baste-stitch around. With left needle position and bight at $2\frac{1}{2}$ millimeters, stitch the right hand side of buttonhole, at the end of which leave needle inside fabric, at point A, Fig. 78. Now, turn fabric around needle until the position as shown in Fig. 79 is achieved. Let needle come out of the fabric, change bight to 5 millimeters and continue stitching from point B, Fig. 80. Now comes the first barring, which, according to the buttonhole length, should be from 1 to 2 millimeters deep. Needle is left inside fabric at point C, Fig. 80, change bight back to $2\frac{1}{2}$ millimeters, and stitch the other side of the buttonhole, Fig. 81. At point D, stop again, leaving needle inside fabric, change bight to five millimeters and now proceed with the second barring, Fig. 82. Take three fastening stitches with bight set at 0.

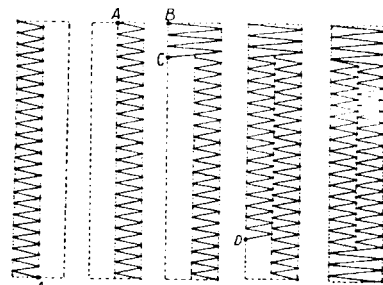

Fig. 78

Fig. 79

Fig. 80

Fig. 81

Fig. 82

For raised or gimp buttonholes, insert gimp thread through eyelet in front of buttonhole foot as shown in Fig. 76, and proceed as with regular buttonholes.

To make buttonholes with other gimps, such as used in ladies' tailoring, proceed in the same manner as above, but reduce the bobbin thread tension. The upper thread tension remains unchanged.

XIV. Air tucking

Air tucking accessories: To make air tucking, as used in ladies' dress-making, (shown in Fig. 84) the air tucking accessory set in Fig. 4 is required, available at extra cost.

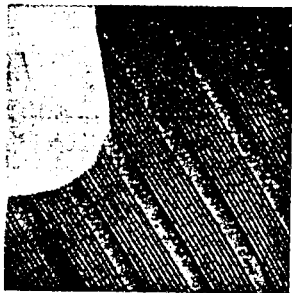

Fig. 84 Top of dress with air tucking



Fig. 83
Finished buttonholes on coat sleeve

Needle position: Bight control A must be set for 0 and needle position lever B on central when using twin needle for air tucks, 4, Fig. 4 (see Fig. 20). With twin needle for air tucks, 5, Fig. 4, a zig-zag work of 1.5 mm and with twin needle for air tucks, 6, Fig. 4, a zig-zag work of 2.5 mm can be performed.

Needle size: For most air tucking in dress and coat fabrics, needle size 14 is correct. Heavy needles are not recommended for air tucking.

Insertion of twin air tuck needle (Fig. 86): The twin air tuck needle is inserted in the same manner as the single needle. It is important to match the correct twin needle with each one of the three air tucking feet.



Fig. 85
Needle clamp with single needle

Upper threads: For the two upper threads, a thread that matches the fabric should be used. Its strength should depend on the fabric being sewn.

Bobbin thread: Should match upper thread.

Threading (Fig. 87): After placing the two spools of thread on the twin spool holder 3, Fig. 1, one of the threads is guided through the left tension and the left needle eye; the second thread through the right tension and right needle eye. Both threads run together through spool pin eye, tension guide, tension spring, tension spring disc, take-up lever, and thread guide.

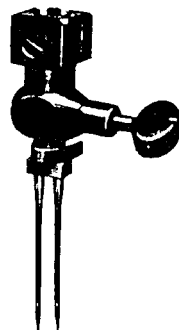

Fig. 86
Needle clamp with
inserted twin air
tucking needles

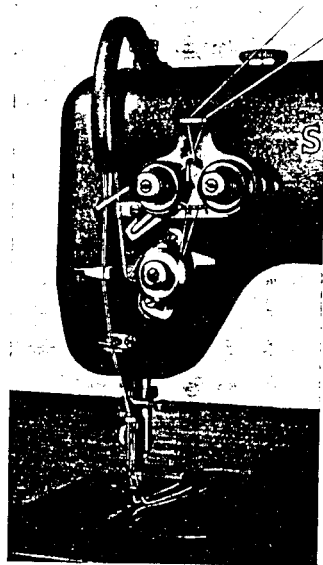

Fig. 87 Threading of both upper threads

Tensions: Should be set as if for plain sewing, both for the upper and bobbin threads. The bobbin thread should not pull the air tuck excessively, yet should provide enough support. The wider the air tuck and the looser the fabric, the slacker the bobbin thread tension should be.

Air tucking attachment (Fig. 4).

The air tucking foot for wide tuck (1) is commonly used in combination with the air tucking covering with tongue (10). In the case that a cord is to be sewn into the tucks the regular feed dog must be replaced by air tucking feed dog (7) and the regular throat plate by air tucking throat plate (8). Hereby, the hole in the centre feed row of the feed dog as well as the groove in the throat plate will serve as cord guide (Fig. 88).

The selection of the correct covering plate depends on the fabrics used and size of the tucks desired.

Throat plate and feed dog can then be left on the machine for all other operations.

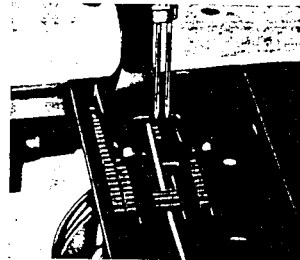

Fig. 88 Threading of cord thread

Inserting the air tucking covering plate with tongue.

Open bed slide and engage the downward bent tongue of the covering plate into the squared opening of the throat plate. The covering plate must rest evenly on the throat plate (as shown in Fig. 89). Close bed slide.

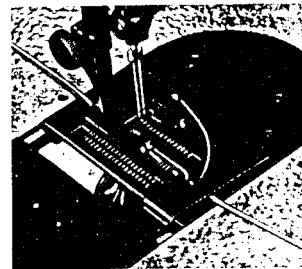

Fig. 89
Inserting the covering plate with tongue

Width and height of air tucks are of course governed by the type of fabric on which they are to be applied, but are also a matter of taste and fashion. It is advisable, before any actual air tucking is made, to try a few test tucks on a surplus piece of fabric. Should it be desired to make tucking that is to run in various directions, light fabrics should be tested to see whether they permit tucks running across or diagonally. Heavier fabrics usually present no problem in this respect. When making close running parallel air tucking (as in Fig. 84), the tuck sewn last will serve as a guide for the next, through the groove in the tucking foot sole.

XV. Needle and thread

Needle Cat. No. 3355 (135 × 17)

Needle size and thread for special jobs.

Type of Operation	Needle Size*	Type of Thread*
Sewing on collars	18, 19	Upper thread No. 50 — 70
Sewing on Badges or Emblems	18, 19	Upper thread No. 50 — 70
Felling Interfacing	18, 19	Upper thread No. 50 — 70
Air tucking (with optional accessories)		Upper thread No. 60 — 50
Blind Felling	11, 14, 16	Embroidery & Darning Thread 70 — 80
Basting with Zig-Zag stitch	18, 19	Basting cotton thread
Sewing on Buttons	18	Upper thread 40, Silk, Nylon
Sewing Buttonholes	18, 19	Upper thread 40, Silk, Gimp Thread
Interfacing with Zig-Zag stitch	16, 18	Upper thread 70 — 80
Bar Tacking	16, 18	Silk thread
Blind Stitching	14, 16	Silk thread
Overedging	16, 18	Upper thread 70 — 80

* Needle size and thread types will depend upon fabric. The above given classifications should serve merely as a guide for average conditions.

SINGER NEEDLES

available at all SINGER shops should be used in SINGER Machines.

Needles in Containers marked "FOR SINGER MACHINES" are NOT SINGER made needles.