

User Guide



ORBIT TP Easy Touch Panel & T021 Remote Control System

CONTENTS

1.	ITEMS INCLUDED BEFORE UNPACKING.....	2
2.	INTRODUCTION.....	3
3.	SPECIFICATION.....	4
4.	FUNCTION SCHEMA & INSTALLATION.....	5
5.	WIRING DIAGRAM.....	5
6.	WARNING.....	6
7.	OPERATION.....	7
8.	ORDER INFORMATION.....	10

ITEMS INCLUDED

Please make sure the below items were included when unpacking. If there is anything missing, please call your local dealer immediately.

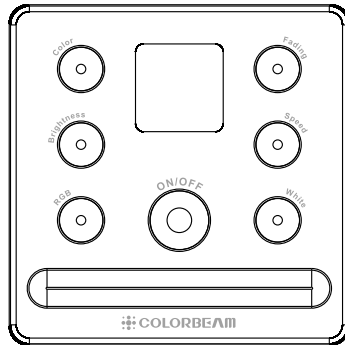

ORBIT TP

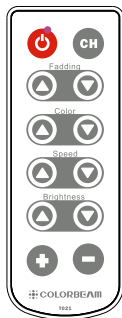

Remote Controller

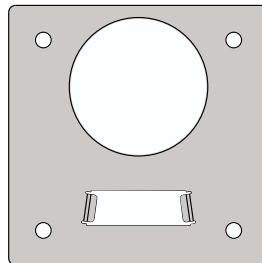

**Wall Fixed Plate
(1pcs.)**



**Screw
(4pcs.)**

INTRODUCTION



COLORBEAM design simple operation control system ORBIT TP and T021 remote control for ORBIT series lights, built in program with 3 channel modes (1 color channel mode, 3 color channel mode, 4 color channel mode) which is suitable with any led lighting fixture in the market.

The Orbit TP with 11 built in fixed color can be memories easily with adjustable the brightness and color, 7 built in fading mode can adjust the speed by user's preferences.

Features:

1. Easy wiring
2. Easy operation by touch panel
3. IR remote control
4. Friendly Interface
5. 3 Channel modes
6. 11-fixed color mode
7. 7-fading mode
8. RGB and WHITE adjusting
9. BRIGHTNESS and SPEED adjusting
10. Memory Capability

SPECIFICATION

Electrical

Input Power Voltage: 24 VDC, 0.08A (1.92W)

Remote Control Battery: Lithium Battery (model no. CR2025)

Communication: USITT DMX512-A address setting

Function

Power on / off

Channel mode (single color, 3colors, 4colors)

11 pre-set static colors

7 pre-set fading mode

RGB, White adjustment individual

Speed adjustment

Brightness adjustment

Storage function

Housing

Dimension (mm): ORBIT TP (L90 × W90 × H21.5)

T021 (L82.89 x W30.89 x H9.4)

Weight: ORBIT TP (138.5 g)

T021 (16.5 g)

Housing Material: ABS

Color: White

Listing

Certifications: CE / RoHS / WEEE

Fixture Warranty: 1 Year

DIMENSIONS

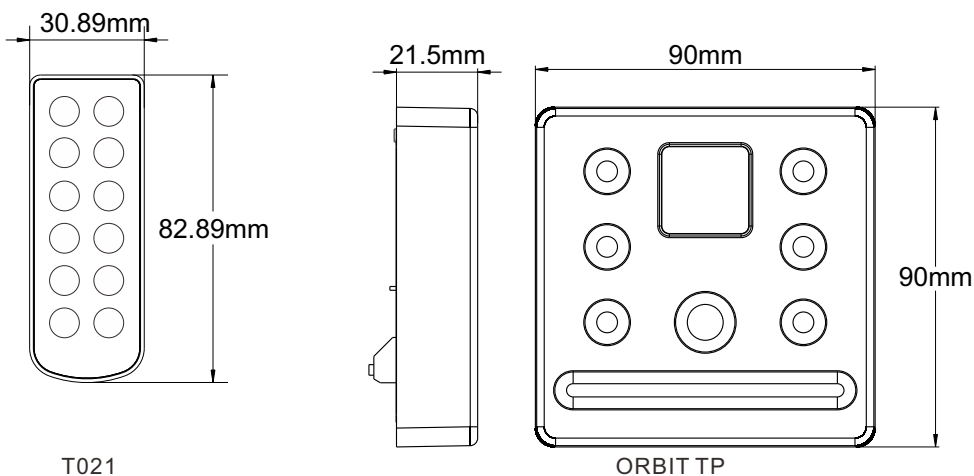

FUNCTION SCHEMA INSTALLATION

FUNCTION SCHEMA

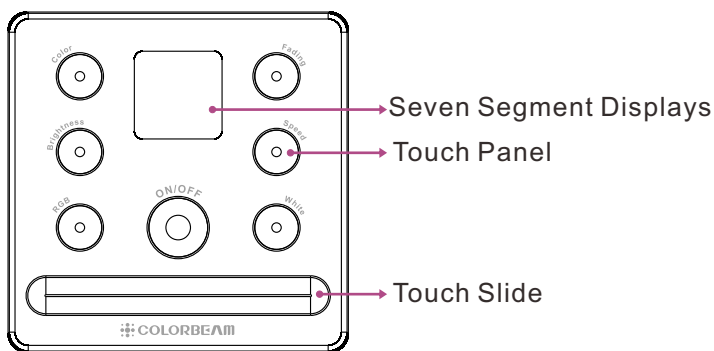
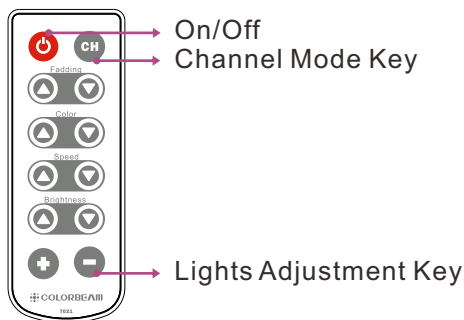

Terminal Block of Wiring

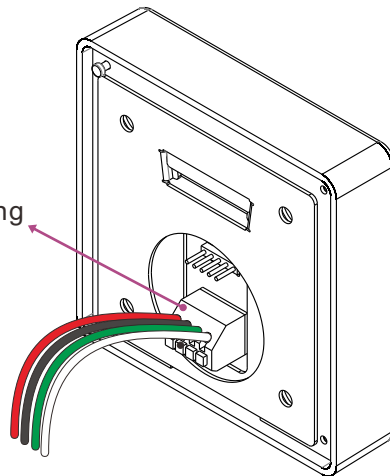

Wiring Information

Symbol	Cable Color	Description
D+	White	DMX+
D-	Green	DMX-
GND	Black	GROUND
DC+	Red	DC24V +

INSTALLATION

Please unplug from the mains before installation.

1. Pass the wires through the metal backplate, and tighten the plate on the wall with 4 screws.
2. Connect the wires to the customized terminal block in accordance with D+, D-, GND, DC+.
3. Place Orbit TP on the metal backplate.

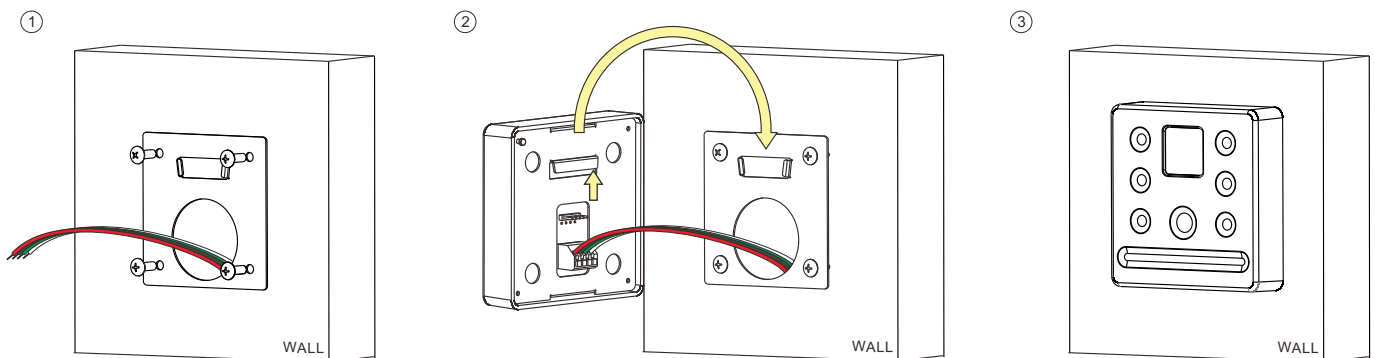

NOTICE:

1. Please notice the idea of the wiring for all Colorbeam fixture is in series connection.
2. The warranty will be invalid when the fixture is not under normal usage (including trimming the cable and do wiring by user).
Please contact with your sales representative for the detailed information if the trimming will be happen.

WARNING

Read the instructions carefully before you install or powering!



CAUTION!

Be careful with your operations.

You can suffer a dangerous electric shock when touch the wires inside the unit.

1. Safety Instructions

Every person involved with installation and maintenance of the this device has to :

-be qualified.

-following the instructions of manual

Please make sure that there are no obvious transport damages.

Please immediately contact the local dealers as the device is in fault operation or damage.

Damages caused by the disregard of this user manual or unauthorized modification to products are not subject to warranty.

Important

Keep this driver away from rain and moisture.

Unplug mains lead before opening the housing.

Make sure the plug is tightly connected with outlet.

Make sure all connector are connected properly.

Make sure the AC power that complies with local electrical codes.

Do not expose the device to heat source, corrosive, flammable or explosive area.

Do not block any of ventilation openings.

Do not open the device and try to repair the device personally.

2. Operation Determinations

The device must only be used indoor.



CAUTION!

For non-Colorbeam fixtures, refer to the wiring diagram for installation.

If the device has been exposed to drastic temperature fluctuation, do not switch it on immediately. The arising condensation water might damage your device. Leave the device switched off until it has reached room temperature.

Only operate the device after having checked the housing which is firmly closed and all screws are tightly fastened. Do not shake the device. Avoid brute force when installing or operating the device.

Operate the device only after having familiarized with its functions. Do not permit operation by persons who are not qualified for operating the device. Most damages are the result of unprofessional operation!

The maximum ambient temperature 40 degree must never be exceeded.

Please consider that unauthorized modifications on the device are forbidden due to safety reasons!

OPERATION

Attention: It is important to read this manual before you install or use this product.

ORBIT TP

•POWER ON/OFF

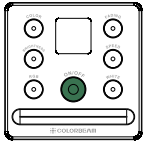

(1) Power ON/OFF

Press the circle with [ON/OFF] letter on the panel to turn the unit ON/OFF. The display will fade out when turning off the device. When the device is turned on, 『---』 will be displayed and it will start in the last used mode.

(2) Memory function

Memory function: The controller will automatically memories the last setting when turn off the unit and will continue to perform when turn on the unit again.

•CHANNEL MODE SETTINGS

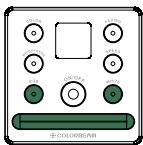

(1) Orbit TP is suitable for single color (1CH) / tri-color (RGB)(3CH) / four-color (RGBW) (4CH) fixtures. Please kindly note that the channels need to be set accurately before operations.

(2) Setting

Press [RGB] and [WHITE] on the device (panel) together and select the channels by slider while the device is turned off. The display will show 『---』 after finished the setting. After finished the setting, touch the button [ON/OFF] to start operating the device.

Channel Mode	First Light
1 Color CH Mode	1CH=W
3 Color CH Mode	1CH=R, 2CH=G, 3CH=B
4 Color CH Mode	1CH=R, 2CH=G, 3CH=B, 4CH=W

•RESET

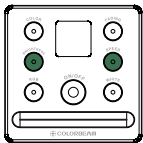

(1) This function is for user to reset to original setting from factory.

Make sure the panel device is in OFF condition and the display shown 『---』 . Touch and hold the [BRIGHTNESS] and [SPEED] together until 『---』 vanish and the display show 『C01』 . When see the display show 『C01』 means the resetting is success.

⚠ Note: T-021 can not operate the reset function.

(2) Original setting

MODE: 4 CH	FADING: F01	RGB: 000	C1: Red	BRIGHTNESS: 255
COLOR: C01	WHITE: 000	LIGHTS: 12	C2: Green	

•SLEEPING

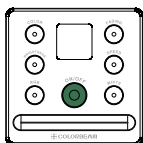

(1) Sleeping Mode

The display will fade out automatically to Sleeping Mode when there's no instruction from the touch panel after 60 sec. Under Sleeping Mode, the touch panel is functional but locked, and the LCD is off.

(2) Press [ON/OFF] button on the device twice to start operation. The LCD will show the last used mode when unlocked.

•DMX ADDRESS SETTING

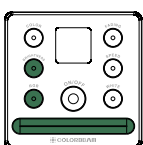

(1) Under the power off circumstances, Press [RGB] and [BRIGHTNESS] on the device (panel) at same time, and select the numbers of lights by gliding the slider. After finished setting, press the circle with [ON/OFF] letter to start operating.

(2) For DMX address setting, please refer user manual of dipswitch page of Orbit lighting include with package.

(3) The maximum channel number can be set up are 60 groups (1 DMX channel needed for single color led fixture / 3 DMX channel needed for tri-color led lighting fixture / 4 DMX channels needed for four-color led lighting fixtures).

(4) For DMX address setting, please refer to page 8, Fading setting.

OPERATION

4 COLOR CHANNEL MODE

•Fixed Color Effects

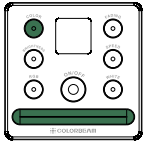

- (1) There are 11 built-in fixed colors. The fixed colors can be selected by gliding the slider on Orbit TP.
- (2) Adjust the hue spectrum value of fixed colors by touching the slider on Orbit TP, and pressing [COLOR] again to create custom colors. When see the display is blinking (one time) means the custom color is saved.
- (3) Operation Example

Condition: Adjust 『C01』 to light orange color under fixed COLOR mode :

- a. Touch the bottom[RGB]and select 『C01』 , using slider to select the number 30.
- b. Touch the bottom[WHITE]to mix the color, using slider to select the number 70.
- c. Touch the bottom[BRIGHTNESS]to adjust the brightness to get your favorite light orange color.
- d. When finish the above steps, touch bottom [COLOR] again to save the new color.

⚠ Note: COLOR mode is not functional under fixed COLOR mode.

•RGB

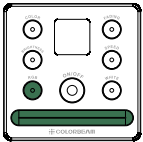

- (1) For a quick change of the color illumination in fixed COLOR mode, the colors can be adjusted touching the slider on Orbit TP.

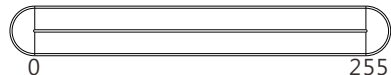

OFF Red Orange Yellow Green Blue Indigo Purple White

- (2)Memory function

Press [COLOR] again on Orbit TP, the changes will be saved and replaced the prime colors.

⚠ Note: SPEED mode is not functional under RGB mode.

•WHITE

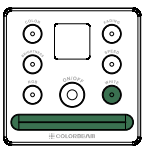

- (1) For a quick change of the intensity, it can be adjusted by gliding the slider on Orbit TP.

- (2)Memory function

Press [COLOR] again on Orbit TP, the changes will be saved and replaced the prime color.

⚠ Note: WHITE only can be applied in CH04 mode. T-021 can not operate this function

•FADING

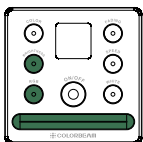

- ⚠ Before operate this FADING mode, please check every lighting fixtures has set the DMX address correctly.

- a. Under the power off circumstances, Press [RGB] and [BRIGHTNESS] on the device (panel) at same time, and select the numbers of lights by gliding the slider. After finished setting, press the circle with [ON/OFF] letter to start operating.
- b. For DMX address setting, please refer user manual of dipswitch page of Orbit lighting include with package.
- c. The maximum channel number can be set up are 60 groups (1 DMX channel needed for single color led fixture / 3 DMX channel needed for tri-color led lighting fixture / 4 DMX channels needed for four-color led lighting fixtures).
- d. DMX setting example:

OPERATION

Example 1

- a. Condition: Total 30 units with RGBW 4-color led, install in 5 groups, needed every 6 units in same address, total needed 5 DMX address number.
- b. DMX address setting
Group 1 (the first 6 units): DMX address setting 1
Group 2 (the second 6 units): DMX address setting 5
Group 3 (the third 6 units): DMX address setting 9
Group 4 (the fourth 6 units): DMX address setting 13
Group 5 (the fifth 6 units): DMX address setting 17.
(For DMX address setting, please refer user manual of dipswitch page of Orbit lighting include with package)
- c. The light group setting must be 5.
(For light group setting, please refer user manual page 10, T-021 instruction)

Example 2

- a. Condition: Total 4 units with tri-color led, every unit need one address, total need 4 DMX address number.
- b. Group 1 (the first unit): DMX address setting 1
Group 2 (the second unit): DMX address setting 4
Group 3 (the third unit): DMX address setting 7
Group 4 (the fourth unit): DMX address setting 10.
(For DMX address setting, please refer user manual of dipswitch page of Orbit lighting include with package)
- c. The light group setting must be 4.
(For light group setting, please refer user manual page 10, T-021 instruction)

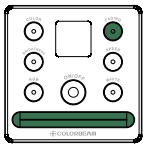

(1) There are 7 preset fading effects

- F01 Color fade: All the fixtures run the fixed colors in order simultaneously.
- F02 Cross fade: All the fixtures will be separated into two groups which based on odd and even numbers. Each group will run a smooth transition from one solid color to another sequentially.
- F03 Color Cavort: An animated color effect will chase in order from the first fixture to the last one.
- F04 Color Sweep: A smooth color transition will spread from the first fixture to the last one
- F05 Rainbow Cavort: A sequence of rainbow colors will chase from the first fixture to the last one in one direction.
- F06 Rainbow Sweep: A sequence of rainbow colors moving in one direction gradually.
- F07 Color fade: All the fixtures run the fixed color C1 and C2 in order simultaneously. example: C1→C2→C1→C2→C1→C2.

(2) The FADING effects can be selected by gliding the slider on Orbit TP.

(3) Memory function

In fading mode, the changes are saved automatically each time when enter a new value.

(4) Operation Example

Condition: Under the FADING mode, adjust BRIGHTNESS and SPEED of F01 .

- a. To adjust the brightness of F01 , touch the [BRIGHTNESS] bottom first, and slide the slider to get favorite brightness.
- b. To adjust the speed of F01, touch the [SPEED] bottom first, and slide the slider to get the favorite speed.
- c. The adjustment of BRIGHTNESS and SPEED will save automatically. Please do not touch [FADING] bottom again.

⚠ NOTE: RGB and White mode cannot be used in FADING mode, the display will shown 『---』 ; only the BRIGHTNESS and SPEED can be adjusted.

NOTE: In FADING mode, the lowest brightness value can only be adjust to the 100(adjust range: 100~255).

OPERATION & ORDER INFORMATION

•SPEED

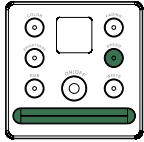

- (1) In FADING mode, it can adjust from value 1-20 for the desired color.
- (2) For a quick change of the speed in FADING mode, the colors can be adjusted by gliding the slider on Orbit TP.

•BRIGHTNESS

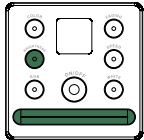

- (1) For a quick change of the brightness in COLOR and FADING mode, the colors can be adjusted by touching the slider on Orbit TP.
- ⚠ NOTE: In FADING mode, the lowest brightness value can only be adjust to the 100 (adjust range: 100~255).

3 COLOR CHANNEL MODE

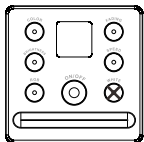

- (1) In 3 color channel mode, only WHITE can't be display. The other functions are the same as 4 Color channel Mode.

1 COLOR CHANNEL MODE

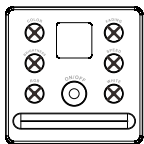

- (1) In 1 color channel mode, only the slider can adjust BRIGHTNESS . 『---』 will be shown when press other button.

T-021

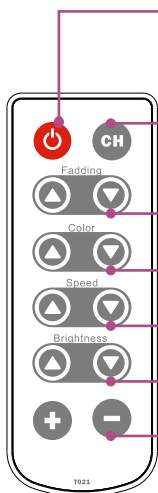

- 1、 Press the button 「」 to turn on/off the device.
- 2、 When the device is in the Sleeping Mode, please press [ON/OFF] on the T021 remote for 6 seconds to start operation.
- 1、 Press 「」 to see the present channel mode.
- 2、 To adjust the channel mode, press 「」 and hold the button still for 3 seconds until the display flickering then select the channel mode. After finished setting, press 「」 to operating the device.
- Press 「」 and 「」 to select the fading mode.
- Press 「」 and 「」 to select the fixed color.
- Press 「」 and 「」 to adjust the fading speed.
- Press 「」 and 「」 to adjust the brightness.
- 1. Press and to adjust the light group setting in any condition except Fixed Color Mode [C--].
- 2. In Fixed Color Mode, press and to select colors from 1 to 255 for a quick change. Press [COLOR or] again to save the settings.

ORDER INFORMATION FORM

CONTROLLER		
ITEM	SPEC.	PART NUMBER
ORBIT TP	-----	GOBC0111
ACCESSORY		
ITEM	SPEC.	PART NUMBER
ORBIT Extension Cable - 4 Cord Cable with bare wire	1M	D03-994001-002
ORBIT Extension Cable - 4 Cord Cable with terminal block	2M	D03-154002-002
ORBIT - 4 Cord Cable with Y type	30cm	D03-154000-001

COLORBEAM CO. LTD.

314, 3F., No. 87, Minguang E. Rd.,

Taoyuan City, Taiwan 33052

TEL : +886 3 335 7716

FAX : +886 3 331 3386

E-MAIL : sales@colorbeam.com

W : www.colorbeam.com
