

cooking collection

Instructions for use and warranty details

Built In Oven
Model No.: OMF6021

 **kLEENmaid**

Dear Customer,

Thank you and congratulations for choosing Kleenmaid.

Your new appliance has been designed and meticulously tested to ensure that it meets all your culinary requirements, and has been carefully manufactured using top quality materials to give you years of reliable performance.

For best results, carefully read the instructions on how your new appliance is to be installed. Correct installation will avoid delays and unnecessary service call costs.

Once installation is complete, please read this instruction manual carefully and get to know the controls and the features of your new Kleenmaid appliance. These simple instructions will enable you to achieve excellent results from the very first time you use it.

Again, congratulations and thank you for choosing The Best You Can Own.

KLEENMAID

GENERAL WARNINGS

This product is in compliance with the EU 2002/96/EEC Directive.

The crossed out “wheeled bin” symbol on the appliance indicates that at the end of its life-span, the product, as it has to be separately treated from domestic waste, must be conferred to a differential collection centre for electric and electronic appliances or redelivered to the dealer at the time of purchasing a new equivalent appliance.

The user is responsible, at the time of disposal, for taking the device to the appropriate collection point. Failure to do so shall result in punishment in accordance with the current legislation on waste disposal.

Proper differentiated collection is necessary so that the obsolete device can be sent on for environmentally friendly recycling, treatment and dismantling, in order to avoid any possible negative environmental impact or health risk and to permit re-use of the constituent materials.

More detailed information about available systems for collection may be obtained from the local waste disposal services, or from the shop where the device was purchased.

The manufacturer declines all civil or criminal liability in the event of poor or improper installation of the device.

The manufacturer also reserves the right to make any necessary and useful amendments to its products without prior notice.

Dispose of the various packaging materials in compliance with the applicable local Standards.

Carefully read this instruction manual prior to installing or using this device, in order to have all the necessary information for correct installation, maintenance and use of the same.

It is essential for this instruction manual to be kept together with the device for its entire life-span, also in case of transfer to other persons.

This appliance has been designed for domestic use and only for the cooking and heating of food. Any other use, different to that indicated in this manual must be considered improper and consequently dangerous.

The product is in compliance with the 89/109/EEC European Directive as it is destined to come into contact with food products.

This household appliance is compliant with the provisions of the European Community Directives

- **LOW VOLTAGE DIRECTIVE – 2006/95/EC**
- **ELECTROMAGNETIC COMPATIBILITY DIRECTIVE – 2004/108/EC**

The product identification data is stated on the relevant plate applied on the front of the oven. **The plate must never be removed.**

Installation must only be carried out by qualified staff in compliance with the local regulations in force

and following the indications in this manual.

Important: do not lift or pull the oven with your hands.

In case of malfunctioning, disconnect the appliance from the electric mains (do not pull the power supply cable to disconnect the plug) and contact the authorised original spare parts technical after-sales centre.

Do not, in any case, attempt to repair the device.

Correct use of the oven

- This appliance is not intended for use by persons (including children) with reduced physical, sensory or mental capabilities, or lack of experience and knowledge, unless they have been given supervision or instruction concerning use of the appliance by a person responsible for their safety.
- Children should be supervised to ensure they do not play with the appliance. - The use of the device is only intended for adults, keep children out of reach
- The appliance produces heat both in the functioning phase and due to inertia, even when just turned off. Do not touch parts inside the oven during these phases and limit contact with the external parts. Keep children away from the appliance when operating. The accessible parts can become very hot.
- To insert or extract containers or accessories from the oven, always use suitable protective gloves.
- Use only containers able to resist to high temperatures
- Do not leave the appliance unattended during cooking operations that may release greases or oils that may catch fire.
- Never cover the walls or lower part of the oven with sheets of aluminium foil or other objects such as pans or trays. This could damage the oven.
- Do not use the oven to store objects when it is not in use, otherwise damage could be caused to both the oven and the objects when the appliance is switched on.
- Do not sit on or place weight on the open door and do not hang weights on the handle as to do so could damage the product and cause malfunctions.
- Before maintenance or cleaning, isolate the power supply from the oven and, if just used, wait for it to cool.
- Pay attention to the flow of air that leaves the oven when the door is opened when the same is hot.
- Do not use jets of steam for cleaning, which could reach and damage electrical parts.
- If the supply cord is damaged, it must be replaced by the manufacturer, its service agent or similarly qualified persons in order to avoid a hazard. **Attention, this appliance must be earthed in compliance with the standards in force.**

For installation of the oven see the “installation instructions” chapter

Correct use of the oven

- Pre-heat the oven for the strictly necessary time only
- Open the door only when necessary to avoid unnecessary heat losses
- Keep the gaskets clean and efficient to avoid heat dispersion which can cause damage
- Always turn off the oven when no longer in use
- To reduce the formation of condensate owing to the humidity in food, it is always necessary to pre-heat the oven before introducing the foodstuffs. However formation of condensate on the door glass or on the walls of the oven does not compromise its functioning and will tend to disappear with the cooking.

Prior to oven commissioning:

Disconnect the power from the appliance.

Remove all internal packaging and accessories from the oven. Clean the internal surfaces with hot water or neutral detergent (see “maintenance and cleaning” paragraph). Rinse thoroughly with a damp cloth. Wash all oven accessories in the same way and dry everything thoroughly.

Attention:

- Never use this device to warm the premises
- Do not obstruct the passage of cooling air by blocking the ventilation holes of the room and ducts on the appliance.
- Before installation, check that the local power supply is compatible with the data indicated on the product label.
- During use, do not touch the heating elements inside the oven.
- The accessible parts can become very hot during use, it is recommended to keep children out of reach.

Contents

User instructions,	6
First use,	6
Control panel,	7
Instructions for use:	
– conventional cooking,	7
– fan cooking,	7
– defrosting,	7
– grill cooking,	8
Timer touch control,	9
Setting the clock,	9
Minute counter,	9
Cooking time,	9
End of cooking time,	9
Programming automatic cooking,	10
Adjusting beep volume,	10
Light replacement,	11
Removing the oven door,	12
Installation instructions,	15
Flush fitting,	15
Electrical connections,	16

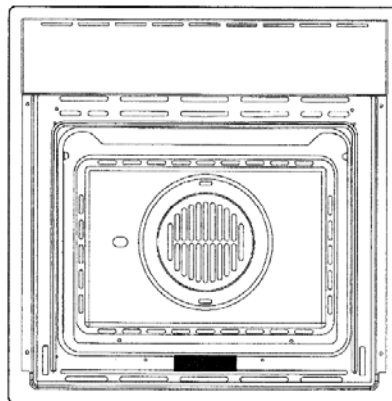

IMPORTANT

The oven's data plate is accessible even with the oven fully installed. The plate is visible simply by opening the door. Always quote the details from it to identify the appliance when ordering spare parts.

User instructions

Important:

Before using the oven for the first time, allow it to operate empty and at maximum temperature for about 1 hour. Ventilate the room well, possibly by opening the windows. This will allow evacuation of the combustion fumes of manufacturing residues such as grease, oil and resin.

Control panel

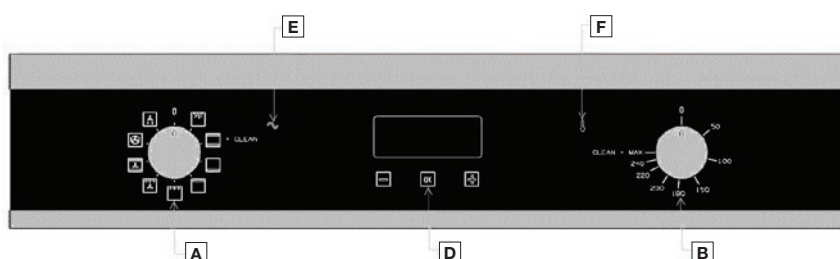

A = Thermostat

D = Clock / Programmer

B = Function selector

E = Red Power Indicator LED

F = Yellow operating LED

Power indicator LED (Red light)

When on, it indicates that the oven is live and on.

Oven operating LED (Yellow light)

When this LED turns on it means the oven is in the pre-heating phase. When it turns off it means the oven has reached the set temperature. When it blinks intermittently it means that the temperature inside the oven is maintained constantly at the value set on the thermostat.

Oven temperature thermostat:

The oven thermostat controls the desired cooking temperature for all oven functions including grilling. Turn the knob clockwise until the mark aligns with the desired setting between 50° and 270°C.

Function switch or selector

This switch activates the desired cooking function.

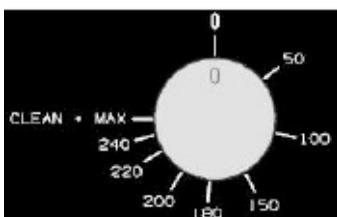
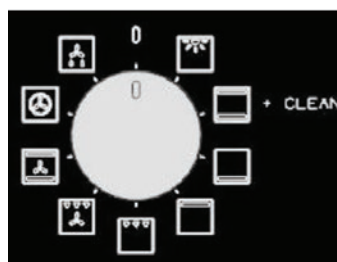

Control panel functions

Function symbols on the selector



Oven is Off.



Oven light.



Top and bottom heating elements.
Thermostat setting from 50°C to MAX.
Also used for CLEAN function.



Top heating element.
Thermostat setting from 50°C to MAX.



Bottom heating element.
Thermostat setting from 50°C to MAX.



Intensive cooking.
Upper + lower heating elements + fan.



Circular heating element with fan.
Thermostat setting from 50°C to MAX.



Grill element.
Thermostat setting from 50°C to MAX.



Grill element with fan (GRATIN).
Thermostat setting from 50°C to MAX.



Defrosting fan.
(See page 8)

Other functions

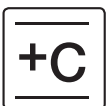

Assisted cleaning.
See 'Using the CLEAN function'.
(See page 11)

Instructions for use



The oven light can be turned on independently at any time in the case of models with this symbol. The light stays on also with other functions.

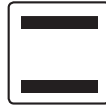

Traditional static cooking + CLEAN FUNCTION

With the simultaneous heat distribution coming from above and below, this function is for baking food that requires slow cooking with the constant addition of liquids. Ideal for any type of roast, bread, cakes and biscuits in general. Use only one shelf for this type of cooking. Otherwise the temperature will not be distributed properly.



Upper cooking

This function activates the heat element at the top. The intense heat diffused from above is excellent for finishing off the baking of food that is cooked on the inside but not entirely on the surface.



Lower cooking

In this case the bottom heating element starts working. Unlike cooking with the upper cooking method, this function is recommended for perfecting the cooking of dishes that are already cooked on the surface but require further cooking in the centre. The intense heat from below is excellent for roasting meat which is not so tender.



Intensive cooking

The activation of the top and bottom heat elements together with the fan ensures even distribution of the intense heat produced. The hot air circulating inside the oven evenly cooks and browns different dishes, on one or more levels, that require similar temperatures. In meat roasts the optimised heat distribution allows cooking at lower temperatures which reduces the loss of juices. This helps to keep the meat tender and minimises any decrease in weight.

Please note that quick heating requires the oven to work at the maximum power declared for this model (see table page 17)



Ventilated cooking

This cooking function allows differing types of foods to be placed on several levels without mixing their flavours, and the evenly circulated hot air allows even baking.



Electric grill

Use the grill to brown foods.



Ventilated electric grill

This function permits grilling in a softer manner thanks to the use of forced air. Forced circulation of air inside the oven increases heat penetration in food and prevents burning on the surface. Consult the "Use of the Grill" paragraph.



Defrost

Only the fan is functioning without any heating element. This function can be used to defrost and/or dry the food to be cooked, only with the movement of air circulating at ambient temperature. This permits the defrosting of dishes without altering their taste or appearance.

It is recommended that food to be cooked is placed in the oven after the oven has been pre-heated.

This appliance is provided with a tangential fan for cooling the control panel and the oven door handle. This fan starts working a few minutes after the start of cooking, when the oven reaches a certain temperature (the time varies according to ambient conditions and oven settings) and also avoids the overheating of the cabinet housing. Hot air will continue to be expelled below the control panel after the oven is switched off, and until the temperature of the oven falls to a normal level.

POSITION OF THE INTERNAL GRILLS FOR SPECIFIC COOKING

Frozen cakes, Long roasts, Turkey, Cakes, Meat Steak well done: Position n. 1 and 2 from bottom

Cakes, Sandwich Load, Toast, Casserole, Wholemeal bread, Meat: Position n. 2 from bottom.

Biscuits, Fine cut meat: Position n. 2 and 3 from bottom.

For Browning with Grill: Position n. 3 from bottom.

These cooking positions are indicative and can be interpreted on the basis of your own experience.

USE OF THE GRILL

To optimise Grill cooking, switch on the grill oven and pre-heat for at least 10 minutes. Introduce the dish inside the oven in the nearest position to the Grill, depending on the type of food to cook. The grill should only be used on each dish for a maximum of 15 minutes at a time.

With the grill it is possible to cook fish, vegetables, small spits and various types of meat, with the exception of lean game meat. Finely cut meat and fish must always be grilled very quickly greasing them slightly with oil using a suitable brush and always placed on the grill. In turn, the grill must be placed nearest to the upper heating element, proportionally to the thickness of the dish, to avoid burning it on the surface and not cooking it enough inside. Only salt the meat after cooking or it will be less juicy. Never prick food during cooking, not even to turn them. Their juice would run making the grilled food dry.









Meat can be arranged in suitable containers or cooked directly on the grill. In the latter case, always pour some water in the drip pan then insert it in the guides under the grill. This prevents the grease in the dripping pan from burning and creating bad odours.

Attention: during use of the Grill, the accessible parts can overheat. It is therefore advisable to keep children at a safe distance.

Never prick food during cooking, not even to turn it. The juice would be released, making the grilled food dry.

Timer touch control

Symbols

	Clock
	Timer
	Oven active
	Cooking time
	Cooking end time
	Number decrease
	Number increase
	Automatic
Man	Manual
	Safety lock

This programmer has touch sensors which are used by pressing lightly in the area indicated by the **+**, **-** and **OK** symbols

Setting the clock

Once the power is connected, the  symbol and the flashing **12:00** numbers appear on the display. The fixed **h:min** symbol also appears, which indicates the time in hours and minutes. By touching any of the **- OK +** symbols, all indicators stop flashing, except the symbol. It is now possible to adjust the time. If no action is taken after a few seconds, this symbol will also stop flashing.

While the  symbol flashes, it is possible to adjust the time by pressing the **- +** symbols. Adjustment is possible from 0&24h in h:min format. By holding the **-** or **+**, the change continues and increases in speed. After a few seconds of not pressing the buttons the time is set. Any adjusting of the time while an automatic program is active will cause the program to be cancelled.



Program select/cancel

A program is selected by touching the **OK** symbol lightly and then scrolling the menu. The illuminated **Man** symbol indicates that the oven is ready for use in manual mode. To display or change a program, press **OK** and scroll this data to modify it, if desired. To cancel a program, set the time value to **0:00**. If power is removed from the oven for more than 5 seconds, any programs previously set will be cancelled.

Manual cooking

For manual cooking, do not use the programmer (the **Man** symbol is illuminated) but only using the temperature and oven function selector knobs. The **TIMER** function can be used while the programmer is in either manual or automatic mode.

Semi-automatic cooking (with cooking end time set)

Touch the **OK** symbol lightly until the  appears. Set the desired cooking time end by pressing the **+ -** symbols. After a few seconds the  symbol switches off, the time re-appears and the **A** and  symbols re-appear. Now turn the two knobs to the desired temperature and cooking function. When the end time is reached, the acoustic signal indicates the end of cooking, the **Man** symbols starts to flash and the oven switches off. Turn both knobs to the off position. Press any symbol to cancel the acoustic signal. Touch **OK** again to exit programming mode. If no action is taken, the acoustic signal is cancelled automatically after about 6 min. A program can be modified at any time by varying the set times. Programming can be cancelled by setting the cooking duration to **0:00**





Symbols

	Clock
	Timer
	Oven active
	Cooking time
	Cooking end time
	Number decrease
	Number increase
	Automatic



Man Manual

 Safety lock

Automatic functioning (with delayed cooking start)

Press the **OK** symbol until the flashing  appears, set the desired cooking time (with **+** **-**). Using **OK** again, go to the flashing  symbol and set the desired cooking end time. The  symbol switches off after a few seconds, the time will re-appear and the **A** symbol switches on. Now turn the two knobs to the desired temperature and cooking function. The oven remains off and will activate automatically, the  symbol lights up to show that a program is set. When the cooking end time is reached the **Man** symbols starts to flash, the oven switches off and the acoustic signal warns that cooking has ended. Turn both knobs to the off position. Touch any symbol to cancel the acoustic signal. Press **OK** again to exit programming mode. If no action is taken, the acoustic signal is cancelled automatically after about 6 min. A program can be modified at any time by varying the set times. Programming can be cancelled by taking the cooking end time to **0:00** Example: it is 11:30, the cooking time necessary is 30 minutes and cooking is set to end at 13:00. The oven will switch on at 12:30 and switch off at 13:00.

Timer function (minute minder)

Press repeatedly on the **OK** symbol until the flashing  symbol appears with **0:00 (min:sec)**. By pressing the **+** or **-** symbols, set the desired time (up to a maximum of 99 min). After a few seconds the programmer will start to count down on the display. The time set can be modified directly at all times by pressing the **+** **-** symbols. When the set time is reached the  symbol starts to flash and the acoustic signal begins. Touch any button to stop the acoustic signal. After a few seconds the clock will re-appear and the  symbol switches off. Set the timer to **0:00** to cancel this function. This function can be used during manual cooking.

Acoustic signal (beeper)

The acoustic signal continues at the end of a program for about 6 minutes. To interrupt it touch any one of the buttons **+** **OK** **-** . The loudness of the signal can be set to three different sound levels in the following way: press **OK** until the letter **L** appears followed by the level currently set (from **L1** to **L3**). Touch the **+** or **-**] symbols to set the desired level. The previous screen returns after a few seconds.

Deleting the program

To delete a program, take the duration of this program to **0:00**. The programmer will return to the manual setting ready for manual cooking or setting a new program.

Safety for children or against accidental operation

It is an additional function that allows to block access to the functionality of the electronic programmer keys both when the oven is running and as prevention with the oven is off. To activate this function, press the **+** button for about 5 seconds, (the  symbol is activated). This prevents children or others from accidentally operating the programmer or starting the oven. De-activate the lock in the same way. Acoustic signals can still be cancelled in the normal way even while the lock is active. If attempts are made to otherwise use the programmer with the lock activated, two warning beeps are emitted and the lock symbol flashes several times to warn that the lock is activated.

ATTENTION: in manual cooking mode (**Man**) activation of the lock does not allow the oven or the timer functions to be used. The lock must be deactivated to change an active program. It remains active even after a power-cut during which programmer is powered off. When power is restored, de-activate the lock before attempting to use the programmer.

Replacing the oven light

To prevent electric shocks and/or damage to persons, read and follow the procedure given below:

WARNING: Ensure that the appliance is switched off before replacing the lamp to avoid the possibility of electric shock.

Ensure that the oven and the light bulb are cold and then remove the protection cover A

Do not touch the hot bulb with a damp cloth, the bulb may break.

Replace the light bulb with another suitable one of 25 W for 220 - 230 V with attachment type E14 suitable for high temperatures.

In case the protection cap is damaged or broken, do not use the oven until the cap has been replaced or re-inserted correctly and safely.

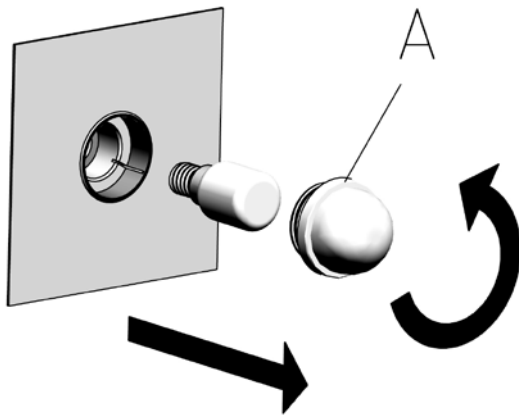

Using the CLEAN function

This oven interior has a unique oleophobic (oil repellent) finish which allows assisted cleaning at much lower temperatures and energy consumption than in pyrolytic ovens. The CLEAN function may be used at any time the oven is not being used for cooking.

1. It is recommended for ease of cleaning but not required that the wire grills, trays, racks and rack holders be removed from the oven and stored in a safe location. If the oven is hot use a thick cloth or oven mitt to do this.
2. Use the timer touch control to set the cooking time to 30 minutes (00:30). Do not set a finish time (immediate start).
3. Set both cooking function and temperature selections to CLEAN. The CLEAN function will commence immediately.
4. When the acoustic signal sounds, set both cooking function and temperature selections to "0" (OFF).
5. Open the oven and allow to cool for 15 minutes.
6. Use a slightly damp cloth to wipe clean the enamel interior of the oven while still warm.
7. If they were removed, return the rack holders, racks, trays and wire grills to desired locations.

Instructions for removing and replacing the door

To remove

1. Open the oven door completely.
2. Insert a 3mm diameter metal rod (not supplied) through the holes in each hinge (see the diagram).
3. Close the oven door with the rods inserted.
4. Hold the door with a hand on each side and lift it up slightly and away from the oven, which will remove the hinges from the slots in the frame of the oven. Never lift the door by its handle.
5. Do not remove the rods from the hinges while the door is off the oven

To replace

1. Re-installation is the reverse of the above procedure.
2. Hold both sides of the door at the centre and insert the ends of the hinges into the slots in the oven frame.
3. Open the door completely and remove the rods from both hinges.
4. Close the door and make sure that it fits evenly against the door seal and is aligned with the side edges.

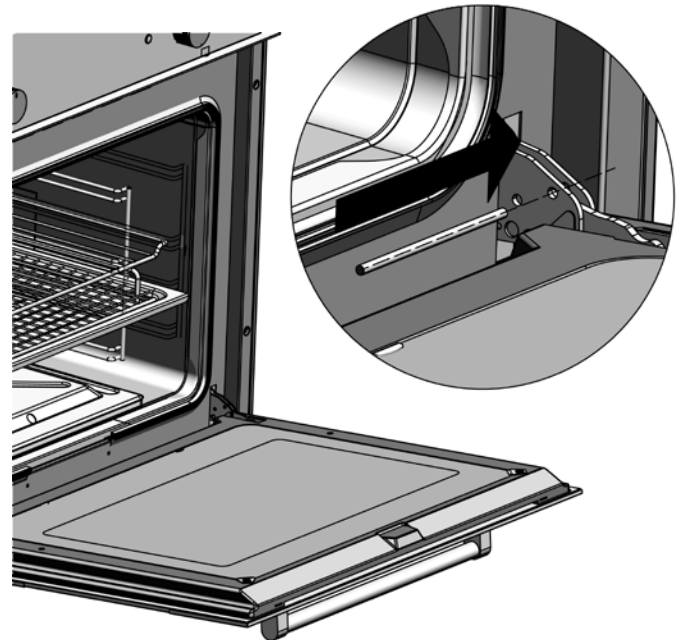

Removing the glass inside the oven door

General notes

To make it easier to clean the door, you can remove the glass inside it. To take it out, follow the instructions below according to the door model mounted on the oven.

Important: To remove the internal glass you need to remove the door from the oven (see paragraph on “Removing the oven door”) and place it on a steady surface that ensures the necessary steps are conducted safely.

Attention: Do not use any kind of blunt or sharp tool that may break the glass or damage the door.

Pay attention to which way you place the glass surfaces when you put them back, as they cannot be turned around. If they are not positioned correctly, this may affect the operation of the oven or even seriously damage the appliance.

Door model with profiles (remove the door from the oven)

For this door model, along with the outer glass, you can also take out the intermediate glass (in models fitted with one)

Remove the oven door, unscrew the 4 clamping screws of the steel plates C (fig. 5) that lock the glass surfaces into place. The glass surfaces can now be removed by slipping them out. Carry out the same steps in reverse order to place

back the glass surfaces. Take the utmost care to ensure they are in the right order and are placed the right way round (the clear glass must be towards the inside and the position of the lettering on the glass surfaces must be as in (fig. 6). Also make sure the protective gaskets are positioned correctly. Some models have a glass anchoring clip that must be repositioned correctly (fig.7) by keeping the clip D against the painted strip on the upper part of the door and inserting the intermediate glass E and inner glass F into place (as shown in the figure)

Before mounting back the door, make sure the glass is firmly secured into place

CAUTION! THE REMOVAL AND INSTALLATION MUST BE CARRIED OUT ACCURATELY AND WITH THE HIGHEST CARE IN ORDER TO AVOID BREAKING OF THE GLASS

Attention: Do not remove the hinge locking hooks from their seat when the door is not mounted in the oven. Do not close the hinges without the weight of the door as it causes a violent closing of the springs.

Do not rest weights on the door and do not hang them on the handle, they might damage the product and cause malfunctioning. Moreover, do not use the oven until the oven door has been re-mounted correctly.

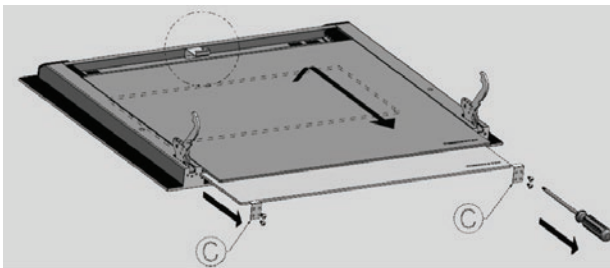

fig. 5

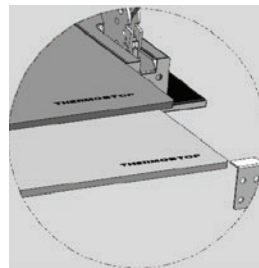

fig. 6

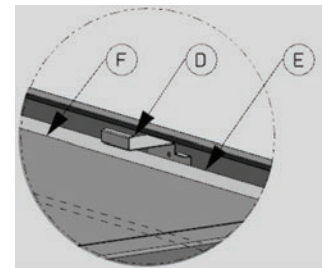

fig. 7

Maintenance and cleaning

Disconnect the electric power supply before performing any type of maintenance on the product

Do not clean the device with steam cleaners.

Do not use rough, abrasive materials or sharp metal scrapers to clean the oven door, as they can scratch or damage the surfaces and cause the glass to break. Do not use acid products (like anti-scaling agents) as they can damage the enamelled parts.

Turn off the heating elements, wait for the internal parts of the oven to cool down before touching or cleaning them.

Pay greater attention to the cooking grills. Clean the oven with care. When cleaning with a wet sponge or soft cloth, take all due care if the surface is hot as it will produce steam and you will risk scalding yourself. Moreover, some detergents create noxious fumes on contact with the heat.

Periodic maintenance

Regularly check the state of the rubber gasket located around the oven opening. It guarantees the correct functioning of the oven. If gasket damage is noted, contact the nearest technical after-sales centre.

Cleaning the surfaces

The enamelled or stainless steel parts must be treated with caution. Use water or specific products, accurately drying with a soft cloth. **Do not use abrasive products.** In case of tough deposits on enamelled parts, use a plastic sponge or similar, soaked in hot water and vinegar. It can become very difficult to remove food residues or stains from oils, sugars, fats, etc. if they are not immediately removed after use of the oven. It will make removing them easier if the internal parts of the oven are cleaned while they are still warm.

Due to an increasing presence of new products on the market it is not possible to establish a list of items suitable for cleaning this device. Read the manufacturer instructions carefully to verify the possible use of the detergent.

Removing/mounting the lateral guides

Proceed as follows to release the lateral guides:

take the guide by lifting it up at the front and pull it towards the inside of the oven (**fig.1**) so that the guide's hook comes out from the slot on the oven's wall.

now pull the guide towards you and lift it by taking it out from its housing at the back (**fig.2**).

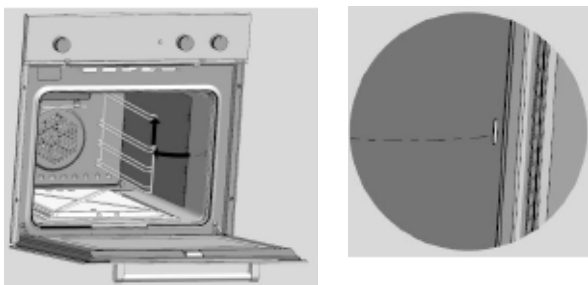

fig. 1

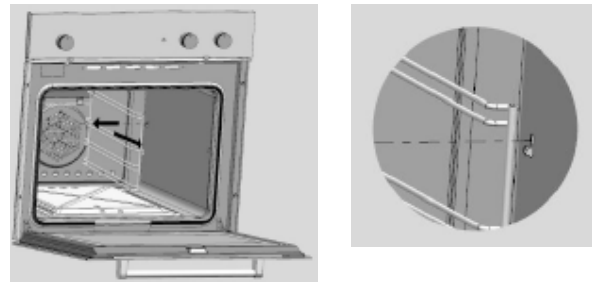

fig. 2

To place back the guides, carry out the steps in reverse order. Always make sure you do not damage the enamel on the oven's walls.

Removing/mounting the sliding guides

There are right and left sliding guides, which means they are not interchangeable on both sides of the oven.

Proceed as follows to remove the sliding element from the lateral guide:

release the lateral guide from the oven together with the sliding element, as reported in the paragraph above.

Place the guide on a flat surface. Now exert some pressure from top down near the couplings in the sliding element (**fig. 3 step 1**). When the couplings underneath come out from the rod of the lateral guide, the sliding element has been released and can be removed. (**fig. 3 step 2**).

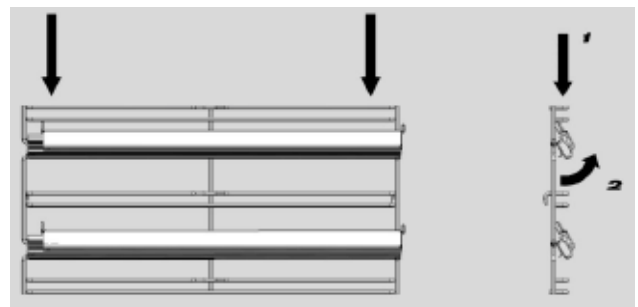

fig. 3

To place back the sliding element, position the upper hooks on the special rods of the lateral guide. Always make sure the sliding element is moving towards the outside of the oven when it is taken out. Now press the sliding element downwards (**fig. 4 step 1**) so that it is coupled onto the lower rods (**fig.4 step 2**).

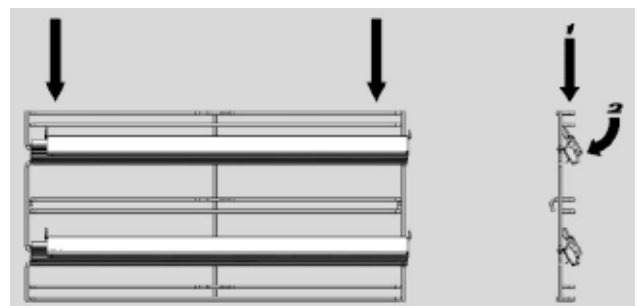

fig. 4

Drip pan insertion (removable guide rails version)

CAUTION use specific hand protection devices if these operations are performed with a hot oven, as the drip pan can be very hot.

With the sliding guides fully inside the oven, insert the drip pan by making the rear side rest at approximately half the length of the slides, and keeping its front slightly lifted (fig.1p).

In this position, push the drip pan until the guide rear end stop is reached; now, put into place the entire drip pan (fig.2p).



Fig.1p



Fig.2p



Fig.3p

Make sure that the holes of the drip pan front are placed inside the end stops of the sliding guide (fig.3p).

To remove the drip pan, pull it towards you and leave it on the side sliding guides until they are fully removed; then, lift it by holding it firmly.

GRILL INSERTION (REMOVABLE GUIDES VERSION)

CAUTION use specific hand protection devices if these operations are performed with a hot oven, as the grill can be very hot.

With the sliding guide rails fully inside the oven, insert the grill by making its rear (side with the rear rod) rest at approximately half the length of the guide rails, and keeping its front slightly lifted (fig.1g).

In this position, push the grill until the rear end stop is reached; now, put into place the entire grill (fig.2g).



Fig.1g



Fig.2g

Make sure that the grill front is placed inside the end stops of the sliding guide rail (fig.3g).



Fig.3g

To remove the grill pan, pull it towards you and leave it on the side sliding guides until they are fully removed; then, lift it by holding it firmly.

Installation instructions

The installation and technical assistance must only be performed by qualified staff. Carefully read the safety instructions in this manual before using the oven. Incorrect installation, maintenance, assistance and use can cause serious damage/injury to persons or objects

This product must be installed as instructed in this manual and in compliance with National Standards and local regulations in force.

Do not lift or pull the oven from the door handle and do not force or load weights when this is open.

The purchaser is responsible for installation. Assistance provided by the manufacturer due to incorrect installation is excluded from the warranty.

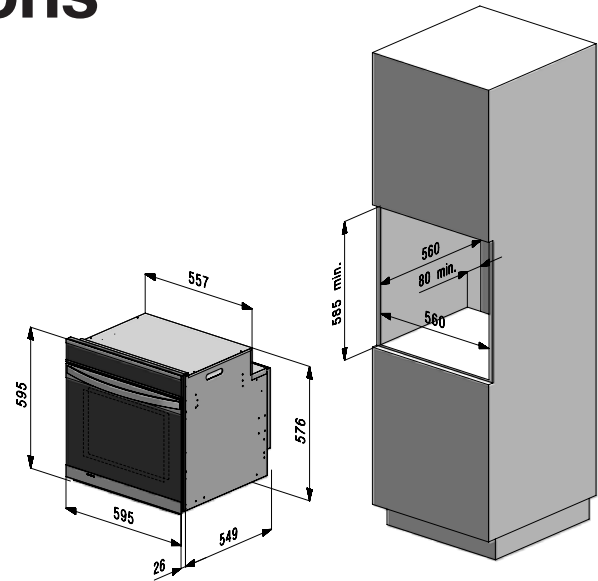

Features of the cabinet

The technical requisites of the cabinet are the following;

- The cabinet and its components must be able to withstand temperatures of up to 90°C without presenting deformities and/or surface defects.
- The cabinet must enable the free passage of the oven connections.
- All household kitchen units must be protected with fire-resistant material in accordance with the standards in force.

Inserting the oven in the cabinet

It is important that all operations relating to installation of the device are carried out by qualified staff. The oven can be installed in a column or below the worktop of a kitchen cabinet.

Built-in measurements

The dimensions of the opening to be made in the cabinet for fitting the oven are indicated in figures. Ensure that the cabinet where the oven is to be installed, is able to support the weight of 30 kg. For the opening in the cabinet follow the dimensions in the respective figure.

It is necessary to create an opening in the rear part of the bottom of the cabinet or in the oven support shelf, to allow sufficient air to circulate for the cooling of the oven during functioning.

Ensure the oven is safely installed inside the cabinet. Use screws to fix the oven to the front face of the cabinet.

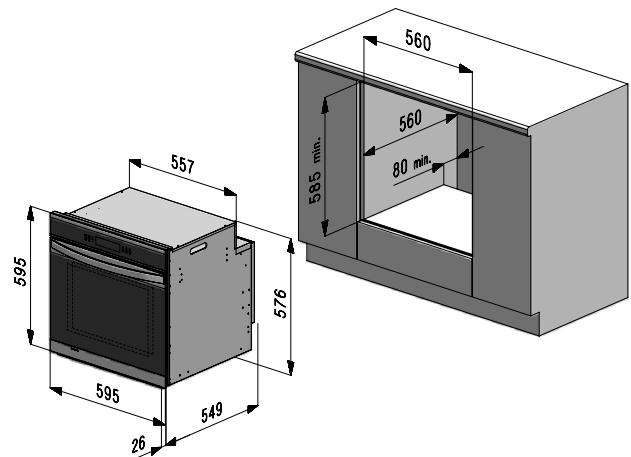

Electric connection of the oven

FIXED WIRING:

Ensure the electric current has been disconnected before connecting the oven to the electric mains.

The oven requires single-phase alternate current 220-230-240 V~ 50-60 Hz, using flexible cable. Ensure the household power supply can support the electric load of the device. (see serial plate). The electric safety of this appliance is only assured if the same is correctly connected to a system having efficient earth connection, according to the legal Standards in force.

In case of permanent connection to the electric mains, apply a bipolar switch dimensioned to the corresponding load, with opening for each contact of at least 3 mm in accordance with the current local regulations.

The installer must ensure that the switch is suitable for the power absorbed by the oven as indicated on the serial plate.

The switch must be easily accessible. Disconnection of the appliance from the electrical supply by the user must be allowed for.

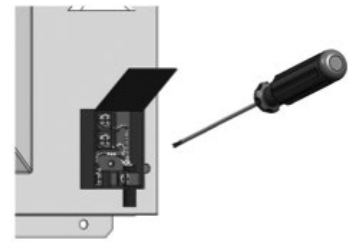
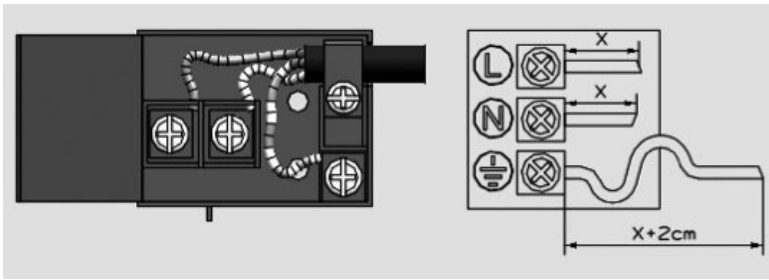

Assembly/replacement of the power supply cable

If the supply cord is damaged, it must be replaced by the manufacturer, its service agent or similarly qualified persons in order to avoid a hazard.

The electric cable must be kept locked to the terminal box by the cable fix, so that it cannot come out. Connect the line cable to terminal **L**, the neutral cable to terminal **N** and the yellow/green cable to the earth terminal \perp . The yellow/green cable must be longer than the other two by at least 20 mm.

Ensure the electric cable does not pass near or come into contact with the surfaces reaching a temperature above 75°C.

Earth connection

Installation, connection and earthing of the electric system must comply with the Australian standard requisites and meet the provisions of the local Standards in force.

This household appliance requires an earthing connection for protection against short-circuits or other electrical faults. It must, therefore, be connected via appropriate electric wiring and isolating switch.

ATTENTION:

DISCONNECT THE ELECTRIC POWER SUPPLY BEFORE PERFORMING TECHNICAL ASSISTANCE OR MAINTENANCE ON THE PRODUCT.

In case of replacement of the electric cable, ensure the use of an electric cable certified according to the Standards in force and suitable to the technical features of the product.

Use only flexible cables:

cable type H05RR-FH 3 x 1.5, H05VV-F 3G1.5

Technical assistance and spare parts

Spare parts

Only authorised components can be used for the appliance repairs. Do not repair or replace any oven component not recommended by this manual. All interventions and repairs must be carried out by authorised technical staff.

To request a spare part, indicate the following data:

- 1) Model of oven (**MOD.**) and production number (**N.L.**), found on the product label positioned on the lower front part of the oven and on the first page of the booklet.
- 2) Description and number of the spare part, technical information available only to the authorised assistance service.
- 3) Last, indicate the details of the distributor that sold the oven and the details of your nearest after-sales assistance centre.

Technical assistance

In case your oven requires technical assistance and/or spare parts, contact the dealer or the authorised technical assistance centre nearest to you.

In this case also it is necessary to state all the appliance data on the aluminium product label, such as: model (**MOD**) lot number (**N.L.**), etc, label placed on the lower part of the oven facade or on the first page of the instructions booklet.

ELECTRIC DATA FOR TYPE AND MODEL									
Voltage 220-230-240 V ~ 50/60 Hz									
			FI-60						
Total power	W		2200						
Top resistance	W		800						
Grill resistance	W		1800						
Base resistance	W		1200						
Circular resistance	W		2200						
Oven light	W		25						
Oven fan	W		30						
Tangential fan	W		20						
Spit	W		-						
EXTERNAL DIMENSIONS									
Width	cm		59,5						
Height	cm		59,5						
Depth	cm		55						
INTERNAL DIMENSIONS									
Gross volume	litres		82						
Grill cooking area	cm ²		726						

Warranty and Service

Domestic Warranty – Full three year warranty

In addition to all statutory rights which you, the Purchaser, have under relevant laws in respect of this appliance, during the first three years of ownership as the original purchaser of this Kleenmaid appliance, Compass Capital Services trading as Kleenmaid guarantee that any fault caused by defective material or workmanship becoming apparent will be rectified free of charge with reference to parts and labour, provided that all service is performed during normal working hours by Kleenmaid or their designated Agents. Where the appliance is installed outside the normal servicing area of the above, the Purchaser must pay for the cost of transporting the appliance to and from the Agent or the Agent's travel cost to and from the purchaser's home.

Commercial Warranty – One year warranty

When this appliance is installed in a commercial application, in addition to all statutory rights which you, the Purchaser, have under relevant laws in respect of this appliance, during the first one year of ownership as the original purchaser of this Kleenmaid appliance, Compass Capital Services trading as Kleenmaid guarantee that any fault caused by defective material or workmanship becoming apparent will be rectified free of charge with reference to parts and labour, provided that all service is performed during normal working hours by Kleenmaid or their designated Agents. Where the appliance is installed outside the normal servicing area of the above, the Purchaser must pay for the cost of transporting the appliance to and from the Agent or the Agent's travel cost to and from the purchaser's home.

What these warranties do not cover

Compass Capital Services trading as Kleenmaid is not responsible for any damage or malfunction unless caused by a defect in material or workmanship. This includes but is not limited to abuse, misuse, improper installation and transportation damage. Compass Capital Services trading as Kleenmaid is not responsible for consequential damages from any malfunction.

This warranty does not cover wear or breakage of consumable items such as door seals, replacement of light globes or glass breakage due to impact. In case of fractured glass do not use your appliance.

Purchaser's responsibility

The Purchaser must make the appliance available for servicing and shall bear any costs incurred for any de-installation and/or re-installation required to make the appliance available for servicing. Compass Capital Services trading as Kleenmaid is not liable for any consequential damage incurred during de-installation or re-installation.

Warranty registration and Proof of Purchase.

Please complete warranty details below and retain together with your proof of purchase document.

When requesting service under this warranty the Purchaser agrees that Proof of Purchase of their Kleenmaid appliance will be necessary in order to make the warranty valid. Inability to provide Proof of Purchase even though this warranty is in place will not bind Compass Capital Services trading as Kleenmaid to repair the appliance at no charge under this warranty and will require the Purchaser to pay for the service costs in full.

Model Number _____ **Date of purchase** _____

For service assistance visit

www.kleenmaidhelp.com.au

Other products available in the Kleenmaid range of appliances

- | Washing machines
- | Clothes dryers
- | Dishwashers
- | Ovens
- | Cooktops
- | Steam ovens
- | Microwave ovens
- | Built in espresso
coffee machines
- | Rangehoods
- | Freestanding ovens

Compass Capital Services Pty Limited
trading as Kleenmaid
ABN 96138214525

Level 2, 204 Botany Road
Alexandria NSW 2015

E: help@kmaid.com.au
www.kleenmaid-appliances.com.au

 **kLEENmaid**