

Progeny Vantage Panoramic X-ray System



User Guide

For Vantage units manufactured during or after October 2012



Contents

- Contents 2
- 1 Regulatory Information 4
 - Indications for Use 4
 - Contraindications 4
 - Warnings and Precautions 5
 - Compliance with Applicable Standards 7
 - Certified Components 8
 - Device Labeling 9
 - Optional Cephalometric Extension Labeling 10
 - EC Declaration of Conformity 11
 - EMC Statement 13
 - Authorized Representatives 13
- 2 Introduction 14
 - Product Description 14
 - Disclaimer about the Manual 14
 - Symbols and Conventions 15
 - Obtaining Technical Support 16
- 3 System Overview 17
 - About the Vantage System 17
 - About the Panoramic X-ray Device 17
 - About the Optional Cephalometric Extension 19
- 4 Projection Summary 23
 - Overview 23
 - Panoramic Standard Projection 24
 - Panoramic Pediatric (Pedo) Projection 24
 - Panoramic Enhanced Projection 25
 - TMJ Projection 25
 - Panoramic Bitewing Projection 26
 - Cephalometric AP/PA Projection 26
 - Cephalometric Lateral Projection 27
- 5 System Walkthrough 28
 - Touch Control Panel 28
 - Tools for Patient Positioning 47
 - Cephalometric Positioning Tools 52
 - Entry and Exit, and Ready for Imaging Positions 53
 - Demo Mode 53
- 6 Preparing to Receive the Image 54
 - About Imaging Software 54
 - Using Progeny Imaging Software 54
 - Using Other Software 57
- 7 Getting Started 59
 - Turning the Vantage System On 59
 - Setting the Technique Factors 60
 - Configuring Device Options 63
 - Configuring the Touch Control Panel 64
- 8 Positioning the Patient 65
 - About Patient Positioning and Image Quality 65
 - Preparing the Patient 65

| | |
|--|-----|
| Setting the Height of the Vantage System..... | 66 |
| Inserting the Chin Rest and Bite Guide | 67 |
| Inserting the TMJ Positioner | 68 |
| Adjusting the Positioning Wands | 68 |
| Using the Positioning Lasers | 69 |
| Cephalometric Positioning (Option) | 73 |
| Using the Demo Mode | 77 |
| 9 Acquiring a Panoramic Image..... | 78 |
| Acquiring an Image..... | 78 |
| 10 Acquiring a TMJ Image | 81 |
| About the TMJ Image | 81 |
| Acquiring a TMJ Image..... | 81 |
| 11 Acquiring a Cephalometric Image..... | 84 |
| Acquiring an Image..... | 84 |
| 12 Recalling the Last Image..... | 87 |
| About Image Preview..... | 87 |
| Recalling the Last Image | 87 |
| 13 Troubleshooting | 89 |
| Characteristics of a Quality Panoramic Image | 89 |
| Characteristics of a Quality Cephalometric Image | 90 |
| Resolving Image Problems..... | 92 |
| 13 Maintenance..... | 95 |
| Regular Maintenance..... | 95 |
| Cleaning and Disinfecting..... | 95 |
| 14 Error Messages..... | 96 |
| Message Overview | 96 |
| Messages and Actions..... | 98 |
| Message Center Interactive Screen | 100 |
| 15 Technical Data Sheet..... | 101 |
| Vantage System Function Checklist..... | 101 |
| System Specifications Sheet | 103 |
| Appendix | 104 |
| X-Ray Tube Information..... | 104 |

1 Regulatory Information

In this Chapter

- Indications for Use
- Contraindications
- Warnings and Precautions
- Compliance with Applicable Standards
- Certified Components
- Device Labeling
- EC Declaration of Conformity
- EMC Statement
- Authorized Representatives

Indications for Use

Statement of Indications for Use

The indications for use of the Progeny Vantage Panoramic X-ray System are to provide dental radiographic examination and diagnosis of diseases of the teeth, jaw, and oral structures. When the system is equipped with the Cephalometric option, the system will also provide cephalometric radiographic examinations for the use in orthodontic treatment planning and evaluation.

Guidelines for Patient Selection

The guidelines for use of the Progeny Vantage Panoramic Extraoral X-ray System are described in the “ADA/FDA Guide to Patient Selection for Dental Radiographs.” This device is to be operated only for the intended use as indicated by prescription of a qualified dental practitioner.

Contraindications

None known at this time.

Warnings and Precautions

Radiation Safety

Only qualified and authorized personnel may operate this equipment observing all laws and regulations concerning radiation protection.

- The operator during X-ray production must remain 2 m (6 ft.) from the focal spot and the X-ray beam for protection.
- Full use must be made of all radiation safety features on the equipment.
- Full use must be made of all radiation protection devices, accessories, and procedures available to protect the patient and operator from X-ray radiation.

Electrical Safety

- Only qualified and authorized service personnel should remove covers on the equipment.
- This equipment must only be used in rooms or areas that comply with all applicable laws and recommendations concerning electrical safety in rooms used for medical purposes, e.g., IEC, US National Electrical Code, or VDE standards concerning provisions of an additional protective earth (ground) terminal for power supply connection.
- Before cleaning or disinfecting, this equipment must always be turned off.
- The Progeny Vantage X-ray System is ordinary medical equipment without protection against ingress of liquids. To protect against short-circuit and corrosion, no water or any other liquid should be allowed to leak inside the equipment.

Explosion Safety

This equipment must not be used in the presence of flammable or potentially explosive gases or vapors, which could ignite, causing personal injury and/or damage to the equipment. If flammable disinfectants are used, the vapor must be allowed to disperse before using the equipment.

Damage and Injury

Do not place permanent or non-mobile structures beneath the device. Device movement may result in damage to the device or structure, or in injury to the operator or patient.

Cleanliness

To prevent cross contamination, always clean the patient contact areas and always install a fresh protective sheath over the bite guide before positioning a patient. The sheath recommended for this application is the TIDI Products, part number 21008.

Laser Safety

Do not stare into the beam. Do not place eyes closer than 100 mm. This equipment contains class 2 lasers of 3 mW output at 650 nm. The beam is a 40° fan line. The lensing on the laser is not removable. Laser on time does not exceed 100 seconds.

CAUTION! Use of procedures other than those contained within this manual may result in exposure to damaging laser light.

Compliance with Applicable Standards

Radiation Protection

The certified components of the Progeny Vantage Panoramic Dental X-ray System comply with Radiation Performance Standards 21 CFR, Subchapter J, at the time of manufacture.

Performance Standards

| Standard | Content |
|----------------------------|---|
| IEC 60825-1:2001 | Safety of Laser Equipment |
| IEC 60601-1 | Medical electrical equipment - Part 1: General requirements for basic safety and essential performance |
| IEC 60601-1-1 | Medical electrical equipment - Part 1-1: General requirements for safety - Collateral standard: Safety requirements for medical electrical systems |
| IEC 60601-2-7 | Medical electrical equipment - Part 2-7: Particular requirements for the safety of high-voltage generators of diagnostic X-ray generators |
| IEC 60601-2-28 | Medical electrical equipment - Part 2-28: Particular requirements for the safety of X-ray source assemblies and X-ray tube assemblies for medical diagnosis |
| IEC 60601-1-3 | Medical electrical equipment – Part 1-3: General requirements for radiation protection in diagnostic X-ray equipment |
| IEC 60601-1-2 | EMI/RFI |
| CAN/CSA 22.2 No. 601.1-M90 | Canadian standard for medical electrical equipment |
| IEC 60601-2-32: 1994 | Medical electrical equipment - Part 2-32: Particular requirements for the safety of associated equipment of X-ray equipment |

Certified Components

| Component | Reference Number |
|---|-------------------------|
| Pan tubehead assembly | 60-A1014 |
| Pan collimator assembly | 60-A2009 |
| Pan X-ray control assembly | 60-A2035 |
| Ceph (Option) sensor assembly | 60-A1004 |
| Ceph (Option) secondary collimator assembly | 60-F4051 |

Device Labeling

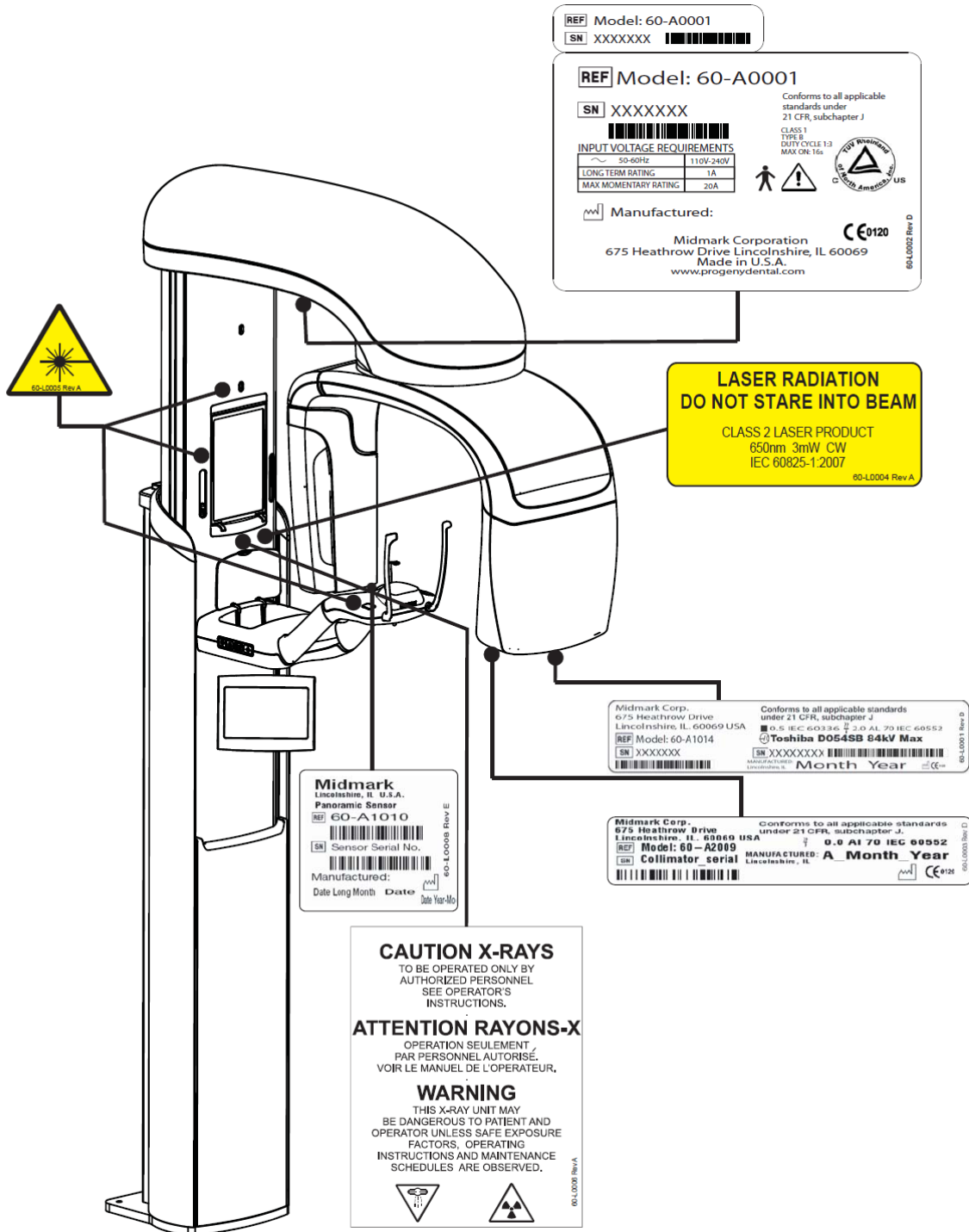

60-L0007 Rev C

Optional Cephalometric Extension Labeling

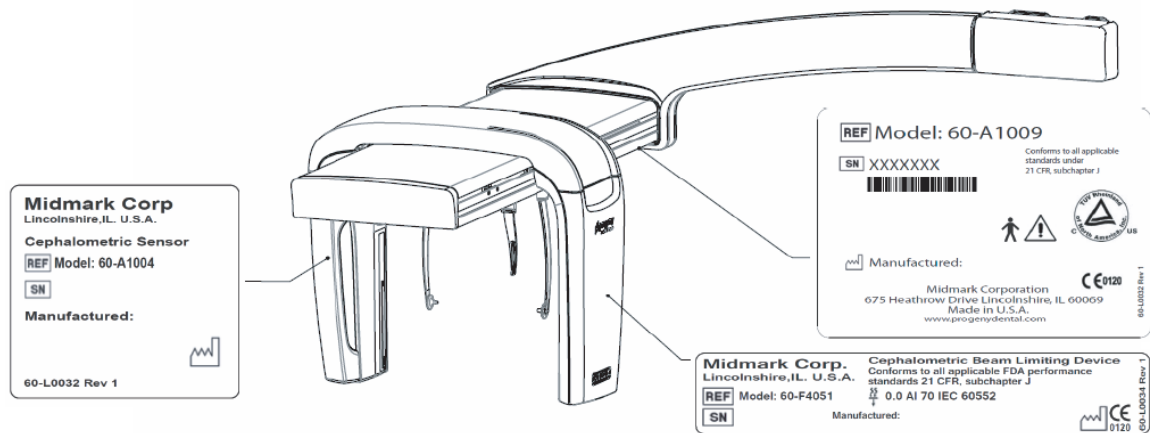

EC Declaration of Conformity

| Name and Description of Product | Progeny Vantage Panoramic Dental X-ray System |
|---------------------------------|---|
| | Catalog V5000 US Domestic Market Model 60-A0001 system |
| | Catalog V5100 Export Market Model 60-A0001 system |
| | Catalog: V5050 Progeny Vantage Panoramic with Ceph Sensor, Domestic Model: 60-A0008 |
| | Catalog: V5150 Progeny Vantage Panoramic with Ceph Sensor, Export Model : 60-A0008 |
| | Catalog: V5000C Progeny Vantage Panoramic with Cephalometric Extension, 2 Sensor System, Domestic Model: V5000 + C6000 |
| | Catalog: V5100C Progeny Vantage Panoramic with Cephalometric Extension, 2 Sensor System, Export Model: V5100 + C6000 |
| | Catalog: V5050C Progeny Vantage Panoramic with Cephalometric Extension, 1 Sensor System, Domestic Model: V5050 + C4000 |
| | Catalog: V5150C Progeny Vantage Panoramic with Cephalometric Extension, 1 Sensor System, Export Model: V5150 + C4000 |
| | Catalog: C6000 Cephalometric Extension with Sensor Model: 60-A1009 |
| | Catalog: C4000 Cephalometric Extension without Sensor Model: 60-A1019 |
| | Catalog: Ceph Sensor only Model: 60-A1004 |
| | Catalog: Panoramic Sensor Model: 60-A1010 |
| | Class: IIb |

| | |
|--|--|
| Reference Numbers to which Conformity is Declared | The following regulatory documents apply: UL 2601-1 IEC 60601-1-2 IEC 60601-1-3 IEC 60601-2-7 IEC 60601-2-28 IEC 60601-2-32 IEC 60825-1 Medical Device Directive ISO 13485 Machinery Directive |
| Declaration | Midmark Corporation declares that the products described herein meet all the applicable Essential Requirements of the EC Medical Device Directive 93/42/EEC in Annex I. For Class IIb products described herein, the product is manufactured, inspected, tested, and released in accordance with the approved quality assurance system established in accordance with ISO 13485 and Annex II of the EC Medical Device Directive under the Supervision of the SGS United Kingdom Ltd., a Notified Body. |
| Contact | Technical Support Midmark Corporation Phone: 888-924-3800 (Press 3) (U.S. and Canada) +1 847-415-9800 (Press 3) (International) Fax: 847-415-9810 techsupport@progeny dental.com Hours: 8:00 a.m. – 5:00 p.m. CT |

EMC Statement

Information Regarding Potential EMC Interference and Advice for Avoidance

- Magnetic and Electrical fields are capable of interfering with the proper performance of this device. For this reason, make sure that all external devices operated in the vicinity comply with the relevant EMC requirements.
- Mains power quality should be that of a typical commercial or hospital environment.
- Power frequency magnetic fields should be at levels characteristic of a typical location in a commercial or hospital environment.
- If the above criteria cannot be verified, precautions shall be taken when using this equipment as the device may inadvertently operate.

Authorized Representatives

North America

MIDMARK CORPORATION
675 Heathrow Dr.
Lincolnshire, Illinois 60069 U.S.A.
Phone: 888-924-3800 (Press 3) (U.S. and Canada)
+1 847-415-9800 (Press 2) (International)
Fax: 847-415-9810

Europe

CE Partner 4U
Esdoornlaah 13
3951DB Maarn
The Netherlands
Phone: +31.343.442.524
Fax: +31.343.442.162

2 Introduction

In this Chapter

- Product Description
- Disclaimer about the Manual
- Symbols and Conventions
- Obtaining Technical Support

Product Description

The Progeny Vantage Panoramic X-ray System is an easy to use and easy to install digital panoramic X-ray system.

The panoramic X-ray provides a broad overview of the teeth, jaw, and oral structure of the entire mouth. The X-ray image supplies information about the teeth, upper and lower jawbone, sinuses, and other hard and soft tissues of the head and neck. The panoramic digital receptor is contained in a C-arm that moves around the patient's head.









The Vantage System has many applications that include evaluation of third molars, evaluation of patients with past and present TMJ (temporomandibular joint) problems, patients who require full or partial removable dentures, dental implants, or braces, those who are at risk or suspected of having oral cancer or other tumors of the jaw, those who have impacted teeth, and those who have had any recent trauma to the face or teeth (i.e., can help identify a fractured jaw).

The optional Cephalometric Extension allows for lateral and PA views of oral structures. The ceph digital receptor is mounted on a transit rail which scans horizontally during ceph examinations. Cephalometric images are typically useful in orthodontic evaluation and treatment.

Disclaimer about the Manual

Midmark pursues a policy of continual product development. Although every effort is made to produce up-to-date product documentation, this publication should not be regarded as an infallible guide to current specifications. We reserve the right to make changes without prior notice. The original language of this manual is English.

Symbols and Conventions

| Symbol | Explanation |
|---|--|
|  | Type B: Protection against electric shock (IEC 60601.1-1988). |
|  | Consult written instructions in the User Guide. |
|  | ATTENTION RAYONS-X: OPERATION SEULEMENT PAR DU PERSONNEL AUTORISE. VOIR MANUEL DE L'OPERATEUR. |
|  | WARNING X-RAY THIS X-RAY UNIT MAY BE DANGEROUS TO PATIENT AND OPERATOR UNLESS SAFE EXPOSURE FACTORS AND OPERATING INSTRUCTIONS ARE OBSERVED. |
|  | X-RAY EMISSION |
| L | Mains HOT WIRE |
| N | Mains NEUTRAL WIRE |
|  | Earth Ground |
|  | LASER RADIATION DO NOT STARE INTO BEAM CLASS 2 LASER PRODUCT. 650 nm, 3 mW |
|  | Power off (circle) Power on (line) |

Obtaining Technical Support

For Technical Support, contact:

MIDMARK CORPORATION
675 Heathrow Drive
Lincolnshire, Illinois 60069 U.S.A.
Phone: 888-924-3800 (Press 3) (U.S. and Canada)
+1 847-415-9800 (Press 2) (International)
Fax: 847-415-9810
techsupport@progenydental.com

Hours: 8:00 a.m. – 5:00 p.m. CT

3 System Overview

In this Chapter

- About the Vantage System
- About the Panoramic X-ray Device

About the Vantage System

The Progeny Vantage Panoramic X-ray System consists of the panoramic X-ray device, the exposure button, and the Progeny client software which is installed on computer system(s) within the dental office network. These computer systems are not provided by Progeny Dental.

About the Panoramic X-ray Device

The panoramic X-ray device consists of the telescoping column, the overhead assembly, the patient positioning table, and the touch control panel.

Telescoping Column

The telescoping column has two main parts: the fixed section and the moving or telescoping section. The fixed section contains the actuator to control up and down movement of the panoramic X-ray device. The telescoping section mounts the patient positioning features. Optical sensors in the telescoping section define the maximum and minimum extension of the column.

Overhead Assembly

The overhead assembly consists of an overhead arm and C-arm. The overhead arm supports the C-arm, which rotates. The C-arm includes the tubehead and the removable sensor. The tubehead produces the X-ray beam, and the sensor is a digital image receptor.

Patient Positioning Table

The patient positioning table guides and supports the patient's head during acquisition of panoramic X-ray images by means of the chin rest, bite guide, and positioning wands. The positioning control on the side of the patient positioning table has 4 buttons for the operator to control the up/down movement of the telescoping column, to apply and release the positioning wands, and to turn on positioning lights. The patient positioning table also contains a storage compartment.

Touch Control Panel

The touch control panel is mounted on the fixed column section under the patient positioning table. It is the main user interface for taking X-ray images with the Vantage System and is activated by touch.

Exposure Button

The exposure button is used by the operator to take the X-ray. The basic configuration consists of an exposure button connected to the panoramic X-ray device by a coil cord.

Bite Guide

A bite guide helps the patient keep his or her jaw correctly positioned. Additional bite guides may be obtained from Progeny. Always install a fresh protective sheath over the bite guide before positioning a patient. The sheath for this application is the Progeny part number 60-S0027.

Chin Rest

An easily removable chin rest fits into an opening on the patient positioning table. Additional chin rests may be obtained from Progeny.

TMJ Positioner

A TMJ positioner for TMJ X-rays fits into the patient positioning table. TMJ positioners are included with the Vantage.

Emergency Stop Switch

The stop switch, mounted under the left side of the patient positioning table near the telescoping column, is for use by the patient. Depressing the button will immediately halt all motor movement. Touching the control panel surface will also abort any movement. The button can be released by turning the knob.

About the Optional Cephalometric Extension

The Cephalometric Extension consists of the support arm, the cephalometric scanning mechanism and the cephalometric sensor.

Support Arm

The support arm is an aluminum casting that mounts to the panoramic column's inner (mobile) component. It mounts via a support casting that allows vertical adjustment of the position of the cephalometric mechanism. The arm can be mounted either to the right, or to the left of the column.

Cephalometric Scanning Mechanism

The cephalometric scanning mechanism is comprised of the rail and the transit assembly. The rail supports the transit mechanism, and houses the motor and bearings that cause the transit mechanism to move. The transit assembly mounts the cephalometric sensor and the secondary collimator, and maintains the alignment of the sensor and secondary collimator to the panoramic tubehead.

The rail also supports the cephalostat, used to position the patient. The cephalostat is comprised of two otic positioning posts which adjust to conform to the width of the patients head, and a nasion locator, which adjusts vertically and laterally to align the patients head. The entire cephalostat rotates in 22.5° increments to support many cephalometric imaging positions.

Cephalometric Sensor

The cephalometric sensor is similar in appearance to the panoramic sensor, but houses within a 21cm long digital detector instead of the 14cm digital detector used for normal panoramic exam. The cephalometric sensor can be used in place of the panoramic sensor, but the panoramic sensor will not operate as a cephalometric sensor.

Vantage System Panoramic X-ray Device

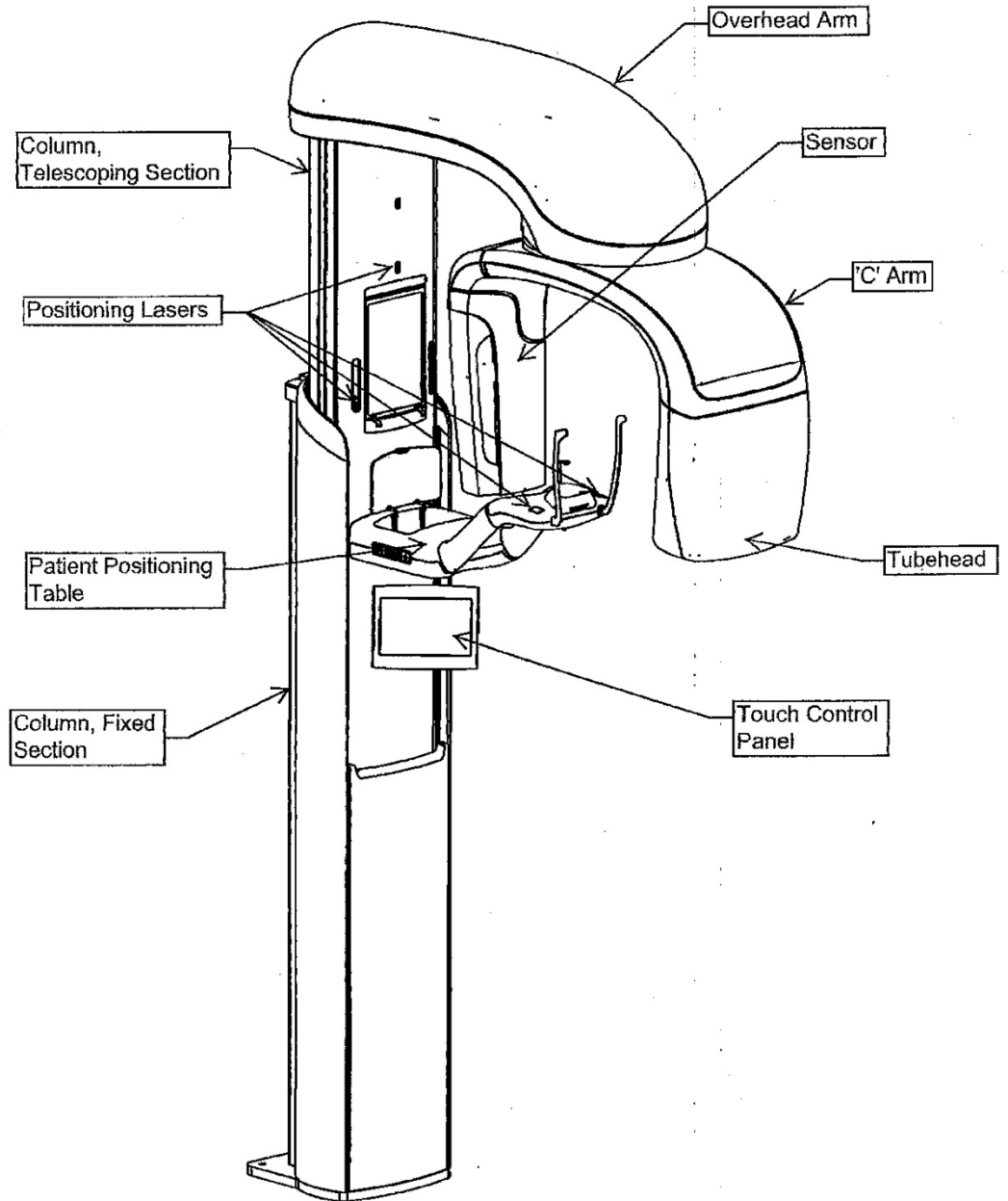

Vantage System Patient Positioning Table

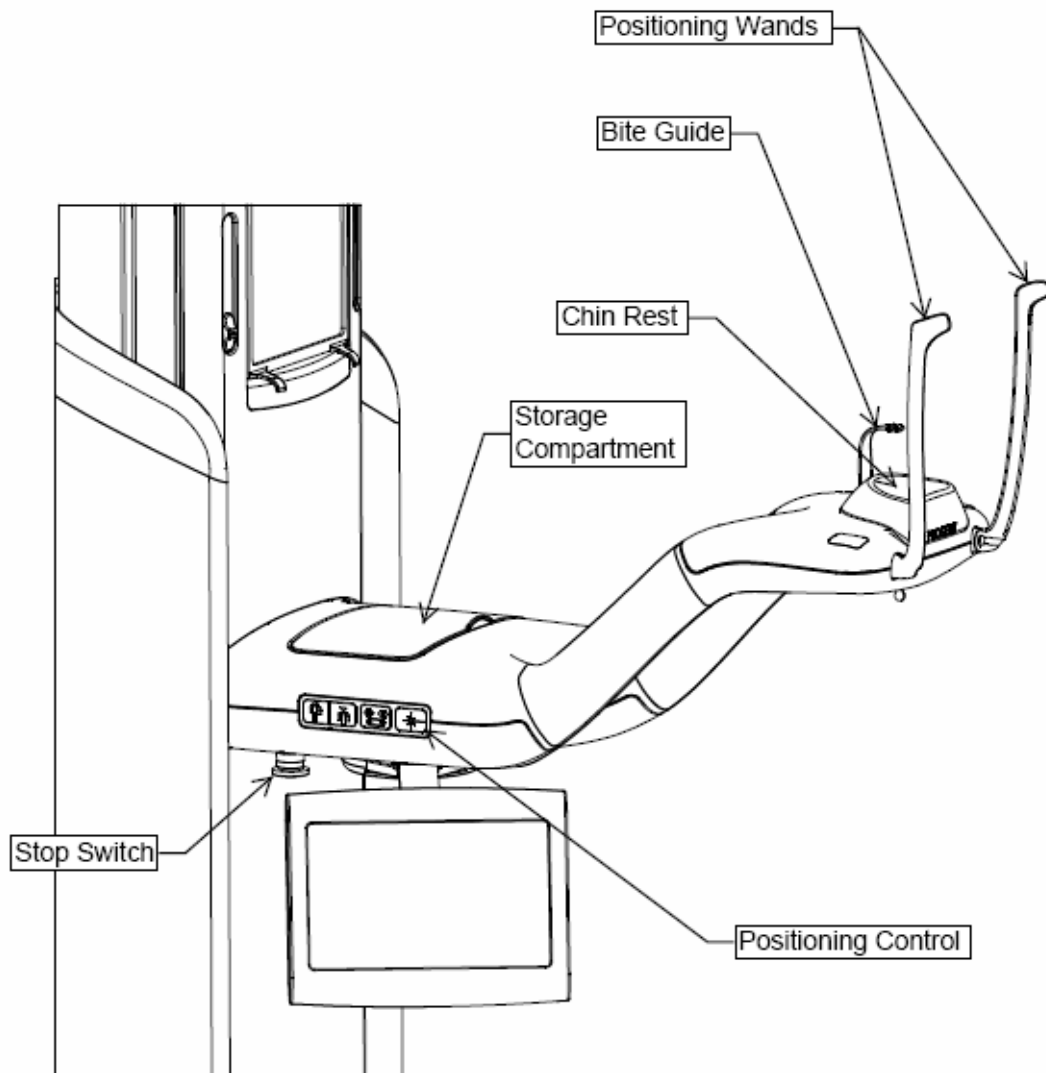

Optional Cephalometric Extension

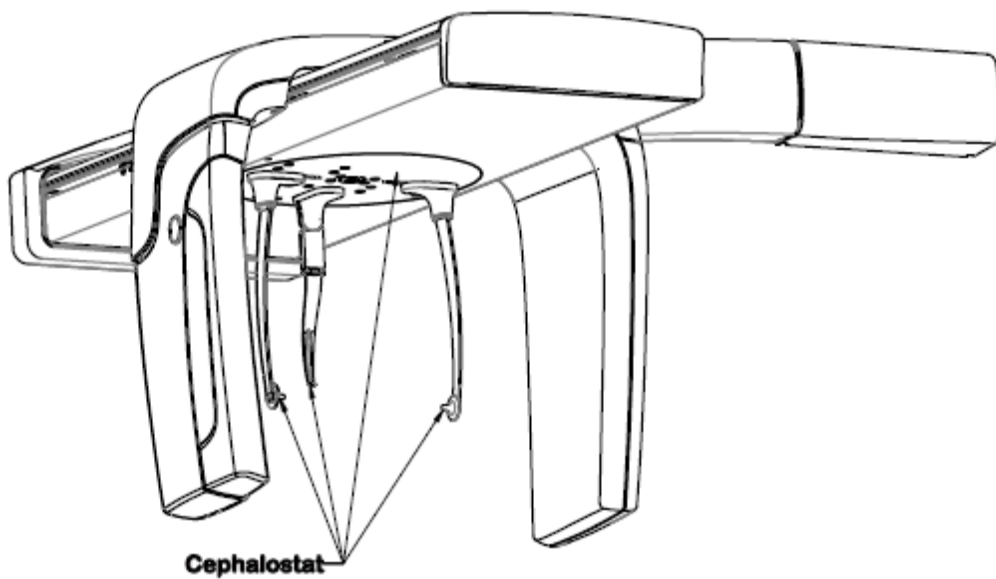
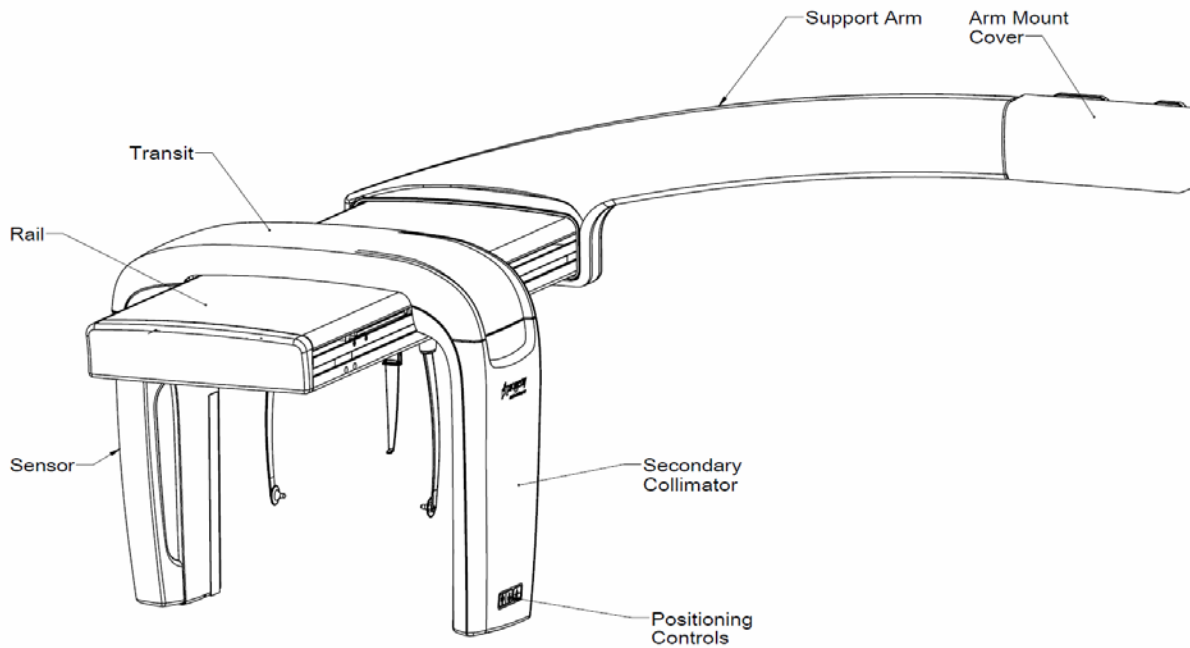

4 Projection Summary

In this Chapter

- Overview
- Panoramic Standard Projection
- Panoramic Pediatric Projection
- Panoramic Enhanced Projection
- Temporomandibular Joint (TMJ) Projection
- Bitewing Projection
- Cephalometric Projections (option)

Overview

The Progeny Vantage Panoramic X-ray System offers multiple projections: a panoramic standard projection, panoramic pediatric (pedo) projection, panoramic enhanced projection with enhanced orthogonality, panoramic bitewing projection, and a temporomandibular joint (TMJ) image.

The Panoramic magnification is a constant 1.2 horizontal and vertical, +/- 0.05. For both panoramic and TMJ images, the basic image size is a standard 300 x 150 mm.

The optional Cephalometric extension offers multiple pre-programmed projections: AP/PA, and right and left Lateral projections. Other cephalometric projections can be made by orienting the cephalostat as needed.

The magnification is a constant 1.1 horizontal and vertical, +/- 0.05. For AP/PA projections, the basic image size is a 180 by 210mm. For Lateral projections, the available sizes are 240 by 210mm and 300 by 210mm

Panoramic Standard Projection

The panoramic standard projection has the traditional path and angles of the X-ray beam. If the patient is a child or very small adult, it is recommended to use the child setting for the exposure where the width of the exposed area is reduced.

Panoramic Standard Projection

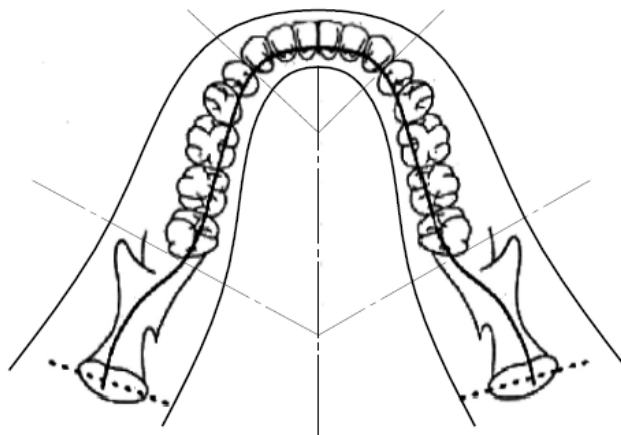

Panoramic Pediatric (Pedo) Projection

The panoramic pediatric Pedo projection is a subset of the panoramic standard projection, with a reduced field projection to limit the patient exposure to radiation.

To identify a Pedo projection, select Child as the Patient Size.

Panoramic Pedo Projection

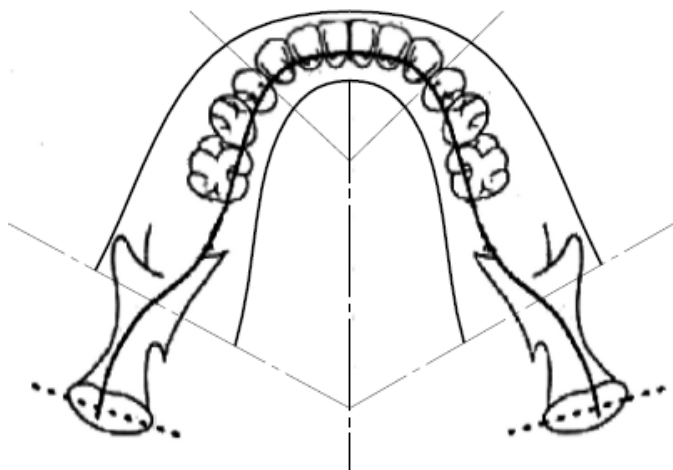

Panoramic Enhanced Projection

In the panoramic enhanced projection, the basic imaging geometry is the same as in the panoramic standard projection except that it includes only the dentition. The panoramic enhanced projection, with the X-ray perpendicular to the jaw, is an improved orthogonal program, and is useful for implant planning.

Panoramic Enhanced Projection

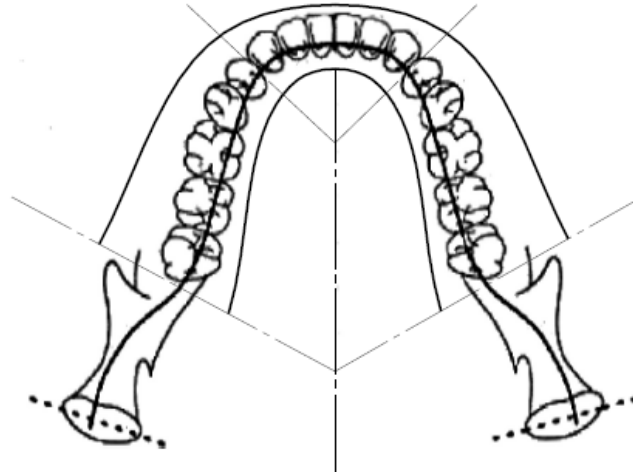

TMJ Projection

The TMJ projection provides exposures of patient's left and right temporomandibular joints.

TMJ Projection

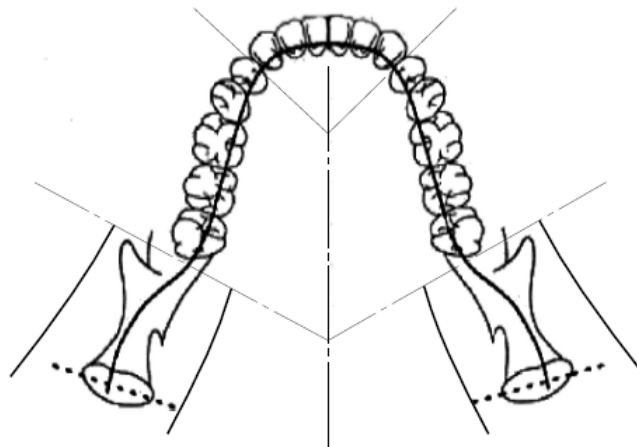

Panoramic Bitewing Projection

In the panoramic bitewing projection, the basic imaging geometry is the same as in the panoramic enhanced projection except that it reduces the vertical collimation to cover only the bitewing portion of the dentition. The panoramic bitewing projection, with the X-ray perpendicular to the jaw, is an improved orthogonal program, useful for bitewing analysis.

Panoramic Bitewing Projection

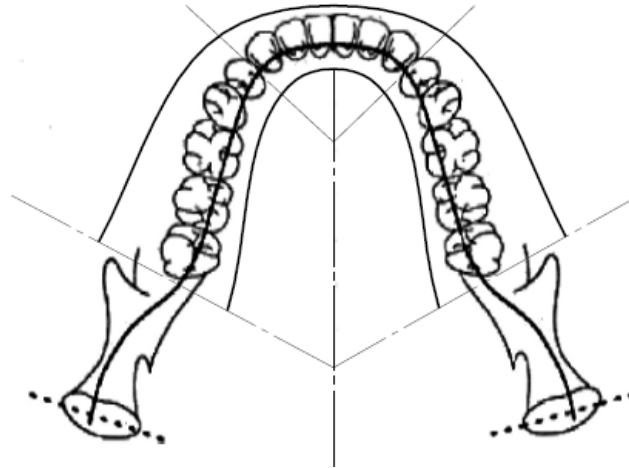

Cephalometric AP/PA Projection

The AP/PA projection is used for orthodontic evaluations. It is performed by rotating the cephalostat so that the nasion marker is toward the sensor (PA) or away from the sensor (AP.)

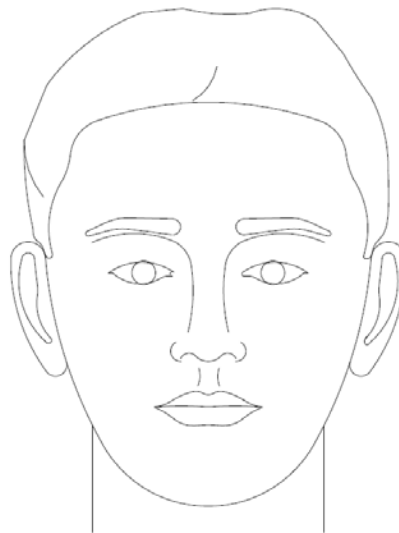

Cephalometric Lateral Projection

The Lateral projection is achieved with the cephalostat positioned with the Otic posts in line with the x-ray tube head. The position of the nasion indicates whether a left or right lateral is produced.

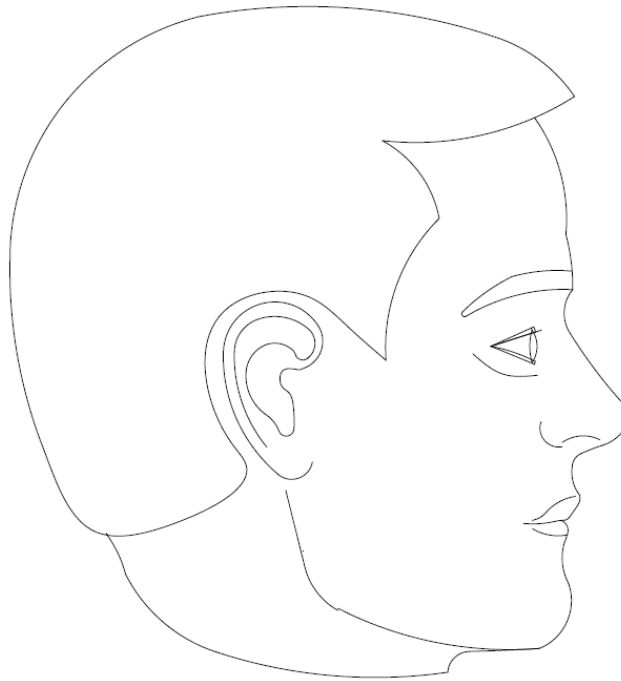

5 System Walkthrough

In this Chapter

- Touch Control Panel
- Tools for Patient Positioning
- Entry, Exit, and Ready for Imaging Positions
- Demo Mode
- Cephalometric (Option) Positioning Tools

Touch Control Panel

The Touch Control panel is the main operator tool for image acquisition. It is mounted on the telescopic column of the Vantage System, and can be swung to either side of the column to make it easier to use.

Touch Control Panel

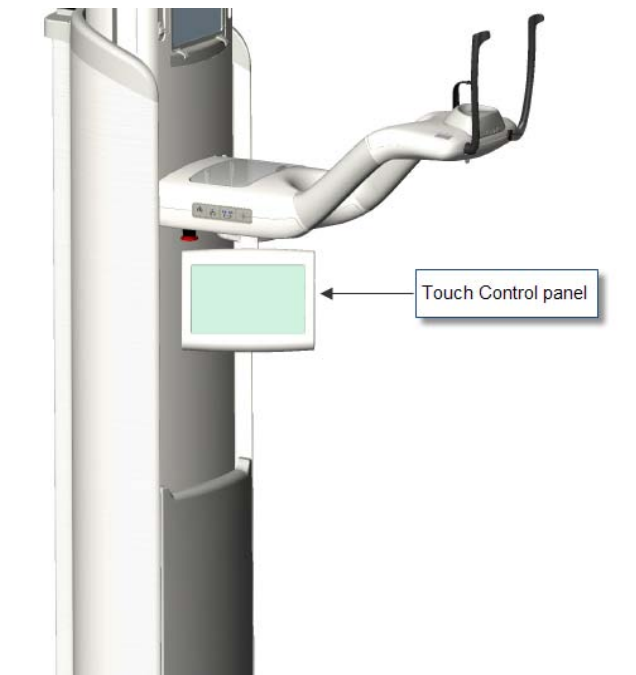

Software on the Touch Control Panel

The user interface software runs on the Touch Control panel. For safety reasons, patient positioning can only be done from the Touch Control panel.

The Touch Control panel displays information pertinent to the current image being acquired. The screen is activated by touch. You tap a button to move to another screen, or you tap an icon to select a value.

The screens and features relating to image acquisition are described next:

- Acquisition Setup screen
- Options screen
- Image Preview screen
- System Center screens
- kV and mA Properties screen
- Profile Properties screen
- Calibration Files screen
- Backup & Restore screen
- VantageTrust screen
- Service screen (Password)

Acquisition Setup Screen

The Acquisition Setup screen is the principal screen used to acquire an image. At the upper left corner is the patient name and dental office. The other information on this screen - the technique factors – is the information you customize for each patient's X-ray.



The technique factors define the intensity and duration of the X-ray. Technique factors include the settings of the projection type, segmentation, patient size, jaw size, and kiloVolt (kV) and milliAmpere (mA) values. *For more information, see Setting Technique Factors in Chapter 7.*

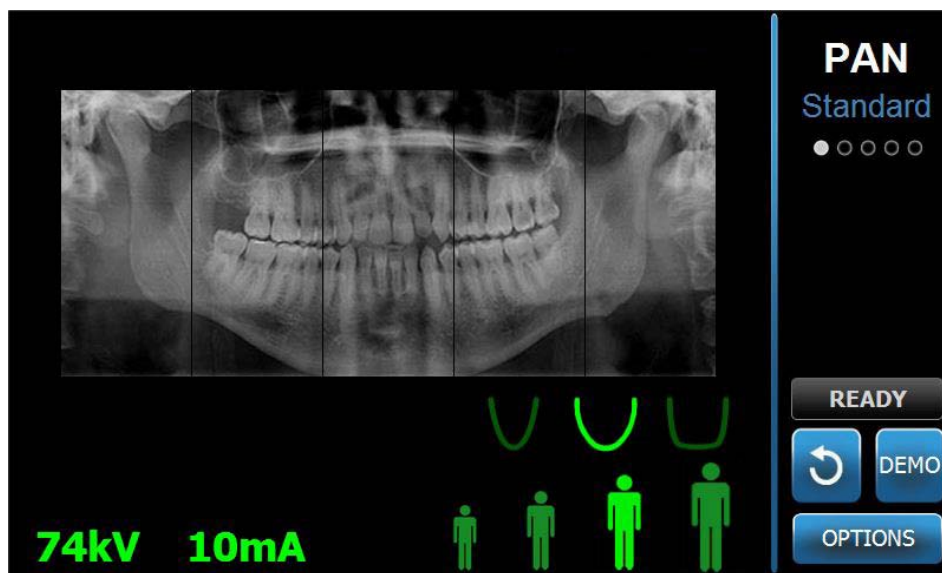





Acquisition Setup screen

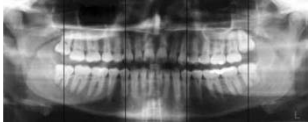

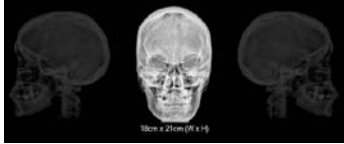



The following table describes the information and functions on the Acquisition Setup screen. The order of the options in the table is not indicative of the entry order.

Options on the Acquisition Setup Screen

| Option | Description |
|---|--|
| Projection  | Four projections are available: Pan Standard (for both adult and child), Pan Enhanced, Pan Bitewing, and TMJ. |
| Patient size  | The Vantage System has four patient sizes, each with its own default kV and mA settings. The patient sizes are Child, Small Adult, Adult, and Large Adult. Adult is the default patient size. |
| Jaw Size  | The jaw size setting determines the form of the focal trough. The three sizes - narrow, normal, and wide - accommodate patients with different jaw shapes and sizes. |
| Segmentation  | By default, the Vantage System images the entire jaw. You can use the segment panels to restrict the image to one or more contiguous segments. The segment panel is dark when unselected, and light when selected. For a TMJ projection type, the Vantage System automatically selects the outermost two segments and does not allow changes. For a Pan Enhanced projection type, the Vantage System automatically selects the innermost three segments, and does not allow changes. |

| Option | Description | | | | | | | | | | | | | | | | | |
|--|--|--------------|----------------|--|----------|----------|-------|----|---|-------------|----|----|-------|----|----|-------------|----|----|
| <p>Ceph Image Type</p>  | <p>The Cephalometric projection is chosen by the position of the Cephalostat. The corresponding selection is highlighted on the acquisition screen, along with the image size. If no selection is highlighted, then the Cephalostat is in a non-standard position.</p> | | | | | | | | | | | | | | | | | |
| <p>kV and mA</p>  | <p>The kiloVolt (kV) and milliAmpere (mA) values that appear are the default Voltage and Current values for the selected patient size, as configured on the Profile Properties screen.</p> <p>The default values appear as green and change to yellow when a value is no longer the default value. You might see one value in green and the other in yellow, indicating that the yellow value is no longer the default value.</p> <p>This table shows the initial default values of the kV and mA settings.</p> <table border="1" data-bbox="821 831 1386 1113"> <thead> <tr> <th rowspan="2">Patient Size</th> <th colspan="2">Default Values</th> </tr> <tr> <th>kV Value</th> <th>mA Value</th> </tr> </thead> <tbody> <tr> <td>Child</td> <td>66</td> <td>8</td> </tr> <tr> <td>Small adult</td> <td>72</td> <td>10</td> </tr> <tr> <td>Adult</td> <td>76</td> <td>10</td> </tr> <tr> <td>Large adult</td> <td>80</td> <td>10</td> </tr> </tbody> </table> | Patient Size | Default Values | | kV Value | mA Value | Child | 66 | 8 | Small adult | 72 | 10 | Adult | 76 | 10 | Large adult | 80 | 10 |
| Patient Size | Default Values | | | | | | | | | | | | | | | | | |
| | kV Value | mA Value | | | | | | | | | | | | | | | | |
| Child | 66 | 8 | | | | | | | | | | | | | | | | |
| Small adult | 72 | 10 | | | | | | | | | | | | | | | | |
| Adult | 76 | 10 | | | | | | | | | | | | | | | | |
| Large adult | 80 | 10 | | | | | | | | | | | | | | | | |
| <p>Ready for Imaging</p>  | <p>The Ready for Imaging button has a dual purpose. It moves the Vantage System to either the Ready for Imaging position or the patient entry position, depending on its current position. If the Vantage System is not already in the patient entry position, tapping the Ready for Imaging button moves it there.</p> <p>When you tap this button, the status indicator flashes "WAIT" to indicate a moving status while the Vantage System moves to the Ready position for image acquisition.</p> | | | | | | | | | | | | | | | | | |
|  | <p>If no sensor is connected and you are <i>not</i> in Demo mode the Ready for Imaging button will indicate no sensor is detected and prevent motion of the machine</p> | | | | | | | | | | | | | | | | | |
| <p>Demo</p>  | <p>The Demo button turns on Demo mode. In this mode, all functions of the Vantage device are available, but no X-rays are emitted.</p> | | | | | | | | | | | | | | | | | |
| <p>Options</p>  | <p>The Options button opens the Options window where you can configure the default values for the Vantage System. <i>For more information, see Options Screen in this chapter.</i></p> | | | | | | | | | | | | | | | | | |

| Option | Description |
|---|--|
| Exposure Time  | This indicator displays the patient Exposure Time, in seconds. |
| Cool Down Time  | When the Vantage device is in cool down mode, the Cool Down Time replaces the Exposure Time. |

| Option | Description |
|--|--|
| Est. Dose | <p>To assist medical personnel and the patient to make informed decisions, the Vantage System displays an estimated dose for the selected image survey to be executed. The estimated dose is shown as <i>Dose-Area Product (DAP)</i> in SI units of $\text{mGy}\cdot\text{cm}^2$.</p> <p>The displayed value is calculated based on a model for the Vantage performance and is not calibrated.</p> <p>WARNING: Use the displayed <i>estimated DAP</i> values only as guidance to the level of X-Ray exposure before the actual irradiation. Do not use the displayed <i>estimated DAP</i> value when a precise dose reading is expected. Instead, use calibrated equipment to measure the actual dose of interest during the X-Ray irradiation.</p> |
| Status Indicator  | <p>When the status indicator displays Ready in green, the Vantage System is ready for imaging. When Ready is gray, the Vantage System is in the exit position. When Ready is yellow, the Vantage System is in the entry position. When Ready is red, the system is in an unknown position, as at initial power up, and moving to find the home position.</p> <p>When a flashing Wait appears, the Vantage System is in motion.</p> <p>When Safe appears, the Vantage System is busy checking components, and is in transition to another screen. This state is temporary. If it lasts more than 5 minutes, restart the Vantage System.</p> <p>When Offline appears, the Vantage System is not connected to the workstation.</p> |
| Cuspid Light Reminder  | <p>When the Vantage moves into patient entry position a reminder is indicated on the top of the acquisition screen to remind you to use the cuspid light.</p> |

Options Screen

As delivered, the Touch Control panel comes with default settings for images and is completely ready to use. The Options screen is used to change any of the default settings or configure differently the behavior of the Touch Control panel. For example, you can use the Options screen to set the peak kiloVolt (kV) and milliAmpere (mA) values for each patient size.



The Options screen is accessed through the Options button on the Acquisition Setup screen.

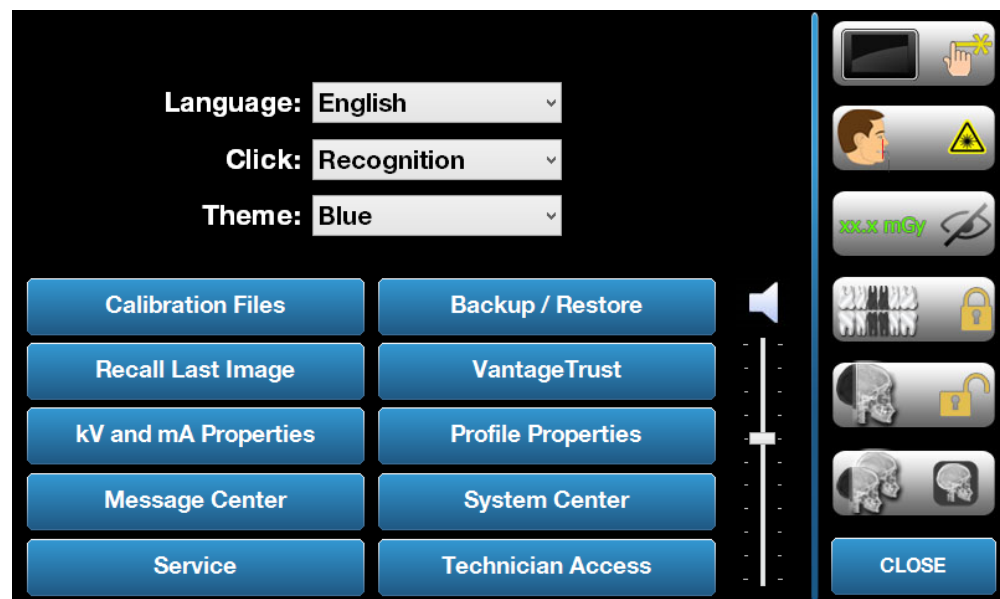



Options Screen



The following table describes the information and functions of the Options screen.

Options on the Options Screen

| Option | Description |
|---|--|
| Click | The dropdown menu lets you decide what type of sound is heard when you tap a button on the Touch Control panel. The options include standard Microsoft Windows™ sounds. |
| Language | The dropdown menu lets you select a language. English is the default language. |
| Audio Level  | The slider button controls the volume of the Click sound. Moving the slider to the bottom makes the sound less audible; moving it to the top makes it more audible. |
| Calibration Files | This button is used to install sensor calibration files on the Vantage System |
| Backup / Restore | This button is used to backup and restore your user settings to/from the Vantage System. |
| Recall Last Image | This button is used to retrieve and redisplay the most recent image acquired. The most recent image is always stored until another image is acquired, or until the Vantage System is turned off. |
| VantageTrust | This button is used to view your current VantageTrust settings. |
| kV and mA Properties | This button is used to set the minimum and maximum kiloVolt (kV) and milliAmpere (mA) values for radiation. |
| Message Center | This button allows you to interactively view messages for specific components of the Vantage Panoramic system. |
| Profile Properties | This button is used to set the default kV and mA values and the jaw size for each patient size. |
| System Center | This button provides access to information on the sensor type, serial number, and number of images taken since the last sensor controller reset. |
| Service | This button is used for maintenance or when a service technician works on the system. It is password protected. |
| Technician Access | This button is used to prepare the machine for a technician to access the Vantage System remotely |
| Slide On/Off  | This toggle button allows you to choose tap or sliding motion to select the projection and one or more segments on the segmentation panel. The button is circled in green when the slide selection is activated. |
| Segment Lock | This toggle button allows you to lock the segments in the |

| Option | Description |
|---|---|
|  | acquisition screen to prevent accidental segment de-selection |
| <p data-bbox="483 359 747 422">Cuspid Light Reminder</p>  | This toggle button allows to enable and disable the cuspid light reminder on the acquisition screen |
| <p data-bbox="483 560 747 592">mGray icon</p>  | This button is used to enable and disable the dose display. |
| <p data-bbox="483 728 747 791">Ceph Segmentation Lock</p>  | This button activates or deactivates the Ceph Lateral segmentation lock |
| <p data-bbox="483 917 747 980">Ceph Segmentation Default</p>  | This toggle button sets the default Ceph Lateral segmentation (image size) |

Recall Last Image

After an X-ray image has been acquired, or when you tap the Recall Last Image button on the Options screen, an Image Preview appears. This Image Preview remains on the screen of the Touch Control panel until you tap the OK button. Be sure to verify that the image acquired is the one desired for the patient.

If you just powered on the Vantage System, and you tap the Recall Last Image button, a non-diagnostic image may appear. This image may not be useful for diagnostic purposes.

Image Preview



System Center

The System Center will allow access to three screens to display system information. The 3 screens are Sensor, Real Time Controller, and VantageTouch Panel. The information in these screens allows the user to verify system revision information and usage information. The information provided is shown in the following screen displays:

Sensor Screen

This screen is informational, and displays the type, serial number, and other information about the currently connected sensor.

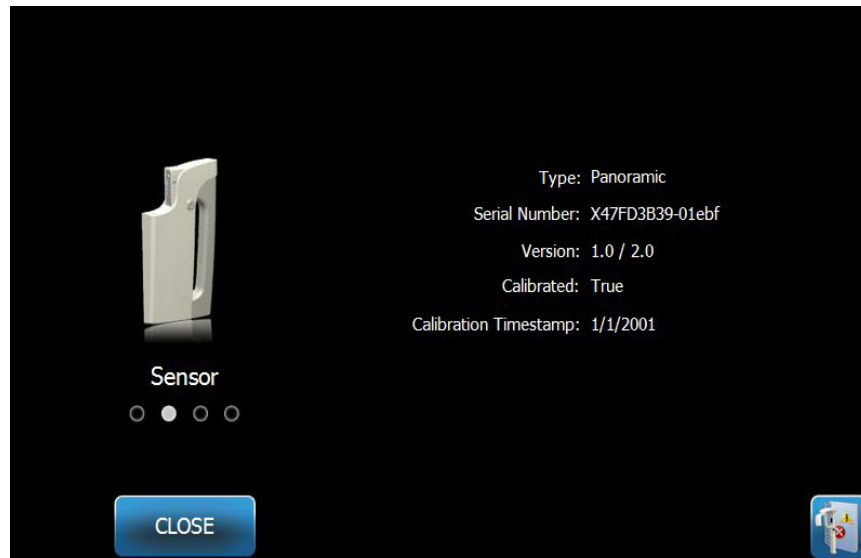

Real Time Controller Screen

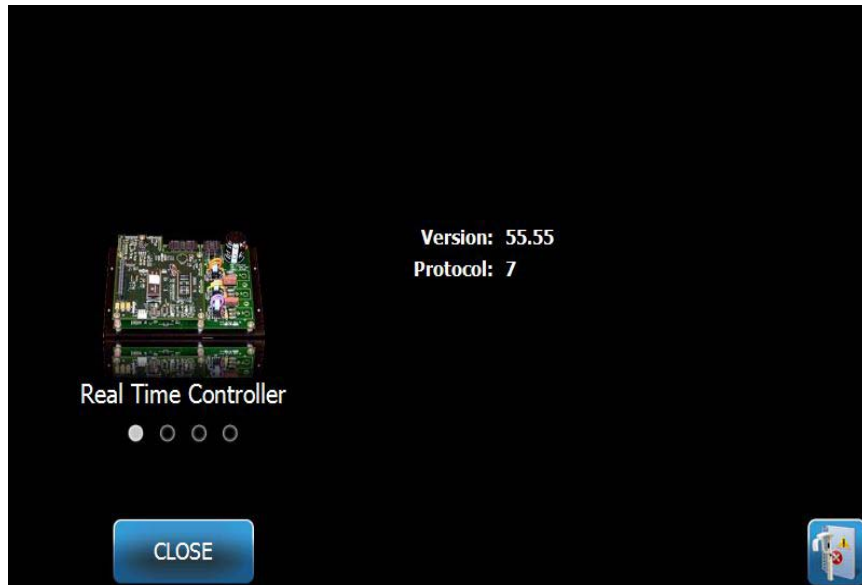

VantageTouch Panel Screen

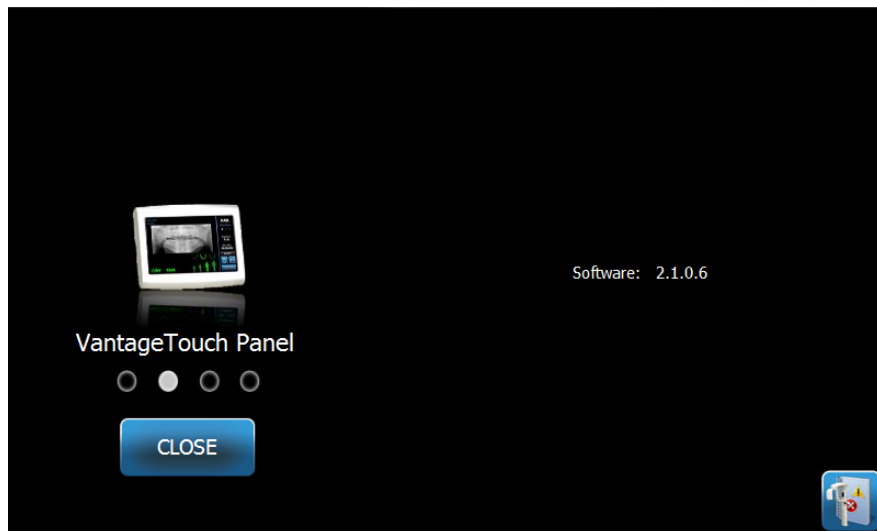

kV and mA Properties Screen

The kV and mA Properties screen provides the user with the ability to limit the minimum and maximum Voltage (kV) and Current (mA) that can be selected for Pan and TMJ images on the Touch Control Panel. Tapping the kV and mA Properties button on the Options screen opens the kV and mA Properties screen.

kV and mA Properties Screen

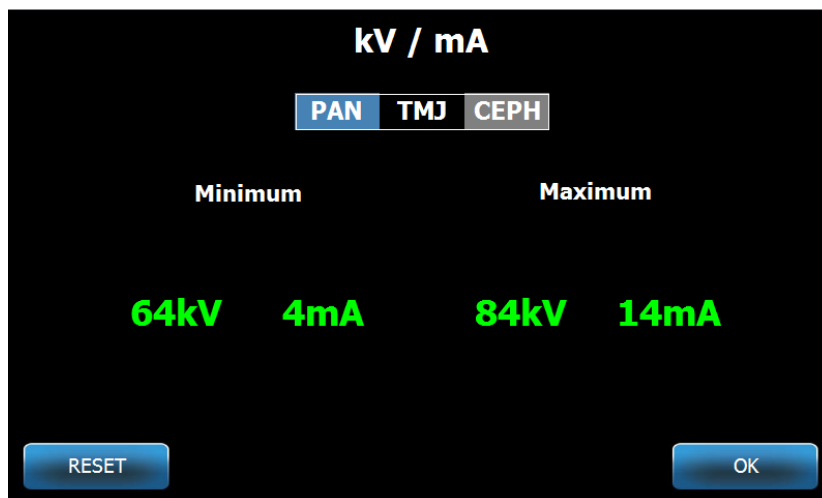

Profile Properties Screen

The Touch Control panel comes with default values for each patient size and is completely ready for use. With the Profile Properties screen, you can modify these values. The default values appear when you select PAN or TMJ and a patient size on the Acquisition Setup screen.

For Pan images, for each patient size, you can define the kV and mA peak values and the jaw size. The kV and mA values must fall within the range already defined on the kV and mA Properties screen. For TMJ images, you can define the kV and mA peak values for each patient size.

When you tap Profile Properties on the Options screen, the Profile Properties screen opens.

Profile Properties Screen

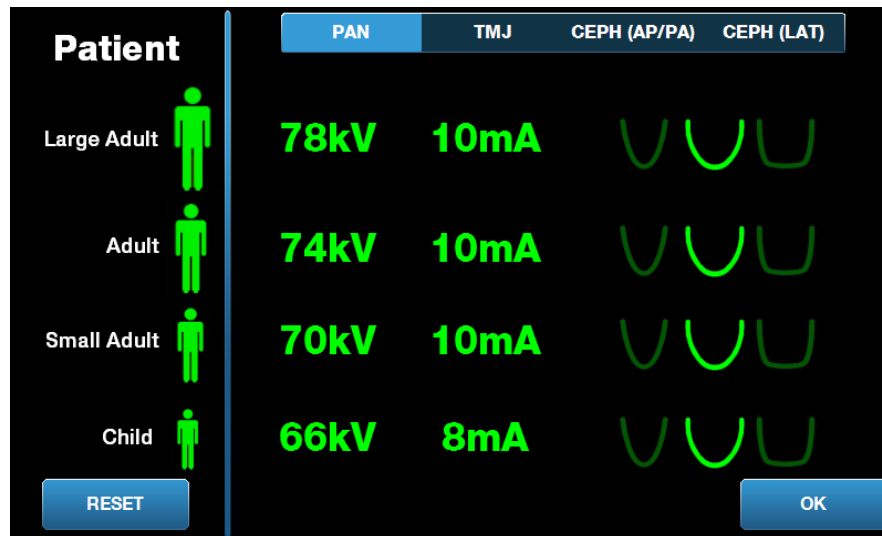

The following table describes the information on the Profile Properties screen.

Profile Properties Screen

| Option | Description |
|--------------------------------|---|
| PAN/TMJ/CEPH AP/PA CEPH LAT | Select the type of image for which you are setting defaults. |
| Patient | All values are set for a specific patient size. This is where you select the patient size to edit. |
| kV and mA Values | Each patient size can have unique kV and mA values that will be used in image acquisition. These values can be further defined for Pan, TMJ, Ceph AP/PA and Ceph Lateral projections. |
| Jaw Profile | For Pan images, you can customize the patient size further by specifying a jaw size: Narrow, Normal, and Wide. |

Calibration Files Screen

The Calibration Files screen is used to load calibration files for Vantage sensors. Any time a new sensor is added you will need to load the calibration files to use it. You can also remove old calibration files by using the list at the bottom of this screen.

When you tap Calibration Files on the Options screen, the Calibration Files screen opens.

Calibration Files Screen

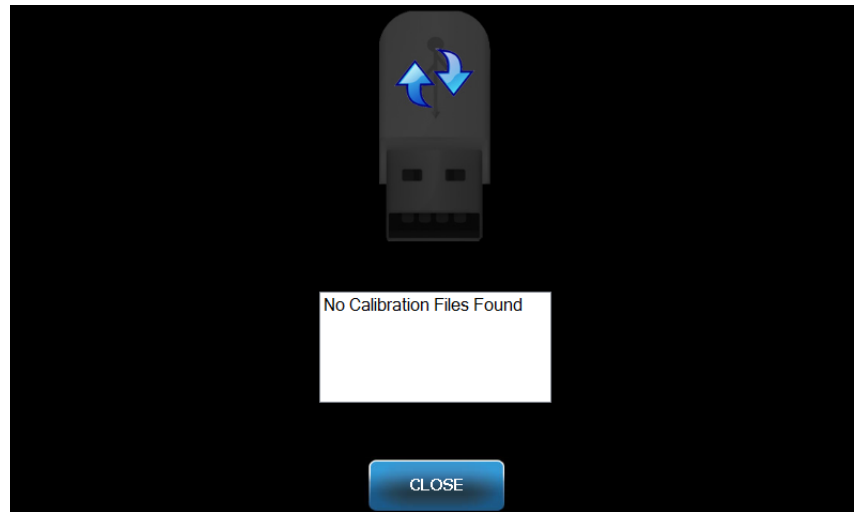

The following table describes the information on the Profile Properties screen.

Calibration Files Screen

| Option | Description |
|-----------------------|---|
| USB Drive | Displays the state of the USB drive plugged into the Control Panel. |
| Calibration File List | Lists all of the calibration files already in the Control Panel. |

Backup / Restore Screen

The Backup / Restore screen is used to backup and restore technique factors, sensor calibration files, and VantageTrust information.

When you tap Backup / Restore on the Options screen, the Backup / Restore screen opens.

Backup / Restore Screen



The following table describes the information on the Backup / Restore screen.

Backup / Restore Screen

| Option | Description |
|---------------|---|
| USB Drive | Displays the state of the USB drive plugged into the Control Panel. |
| Backup Arrow | Displayed going from the Vantage to the USB drive creates or overwrites a backup that already exists. |
| Restore Arrow | Displayed going from the USB drive to the Vantage restores an existing backup to the system. |
| Confirmation | Before a backup or restore occurs a confirmation appears prior to beginning the action. |

VantageTrust Screen

The VantageTrust screen is used to view information about your VantageTrust account.

When you tap VantageTrust on the Options screen, the VantageTrust screen opens.

VantageTrust Screen

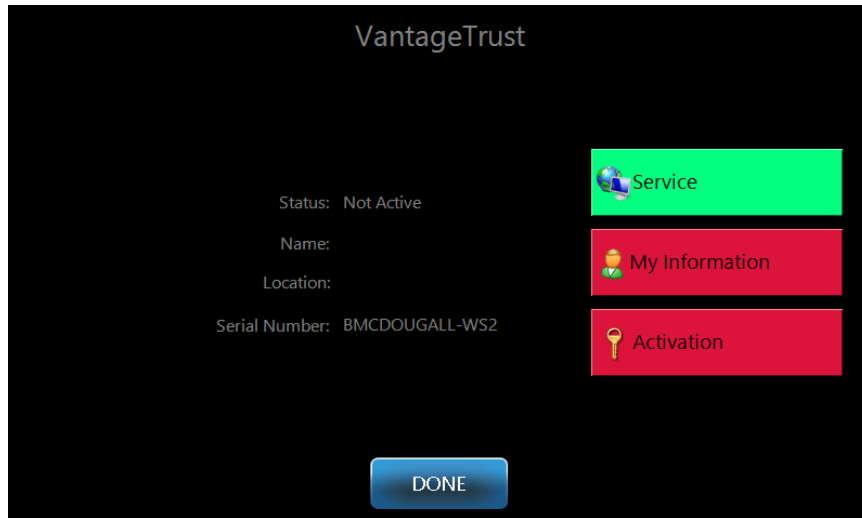

The following table describes the information on the VantageTrust screen.

VantageTrust Screen

| Option | Description |
|----------------------|--|
| Status | The current status of the VantageTrust account. |
| Name | The registered practice name. |
| Location | The registered practice location. |
| Serial Number | Your Vantage serial number. |
| Service Light | Indicator for accessibility of the VantageTrust service online |
| My Information Light | |

Service Screen

The Service screen is a diagnostic and troubleshooting tool, and is used by Service technicians. The Service screen is password protected. When you tap Service on the Options screen, the Service Password screen opens.

Service Password Screen

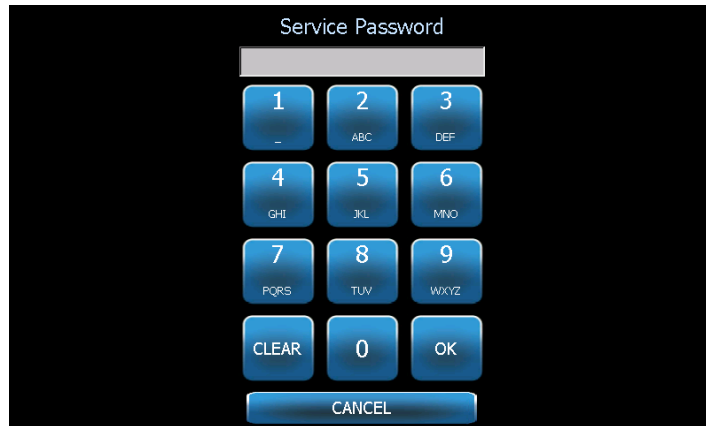

Tools for Patient Positioning

Having the patient correctly positioned for a panoramic X-ray is extremely important for the quality of the image. The size and shape of the area most sharply defined on the image depends on the correct positioning of the patient.

The Progeny Vantage Panoramic X-ray System has built-in tools that make correct positioning quick and easy to accomplish. These tools include:

- control buttons for column height
- the patient positioning table with chin rest, bite guide, and positioning wands
- the laser positioning system with the Frankfort plane laser, mid-Sagittal laser, and Cuspid laser.

Control Buttons for Column Height

The telescoping column of the Vantage System supports the patient positioning table with the chin rest, the bite guide, and the positioning wands. The height of this column and the patient positioning table is easily adjusted from the Control Button panel located on either side of the patient positioning table. A second set of controls are available on the Ceph Extension option for easier Ceph positioning.

Control Button Panel Showing Up/Down Buttons

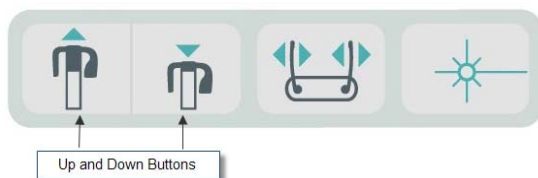

Patient Positioning Table with Chin Rest, Bite Guide, and Positioning Wands

The chin rest, bite guide, and positioning wands are crucial elements for properly positioning the patient. The chin rest attaches to the patient positioning table, and the bite guide attaches to the slot in the chin rest. The positioning wands, together with the chin rest and bite guide, help align the patient's head for the exposure, and control side to side movement.

When removing the chin rest and bite guide, the bite guide must be removed first by pulling upward. Then the chin rest may be lifted out of the Positioning Table.

Patient Positioning Table with Chin Rest, Bite Guide, and Positioning Wands

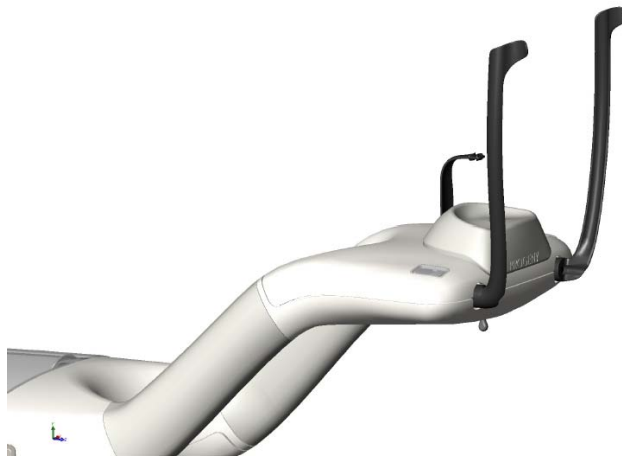

Laser Positioning System

The Progeny Vantage Panoramic X-ray System uses three highly precise lasers to position the patient: Frankfort plane laser, mid-Sagittal laser, and Cuspid laser. Each laser has a very specific function in the proper alignment of the patient and the production of a high quality image.



CAUTION! Class 2 Laser radiation. Do not stare into the beam. 650 nm, 3 mW

Location of Lasers

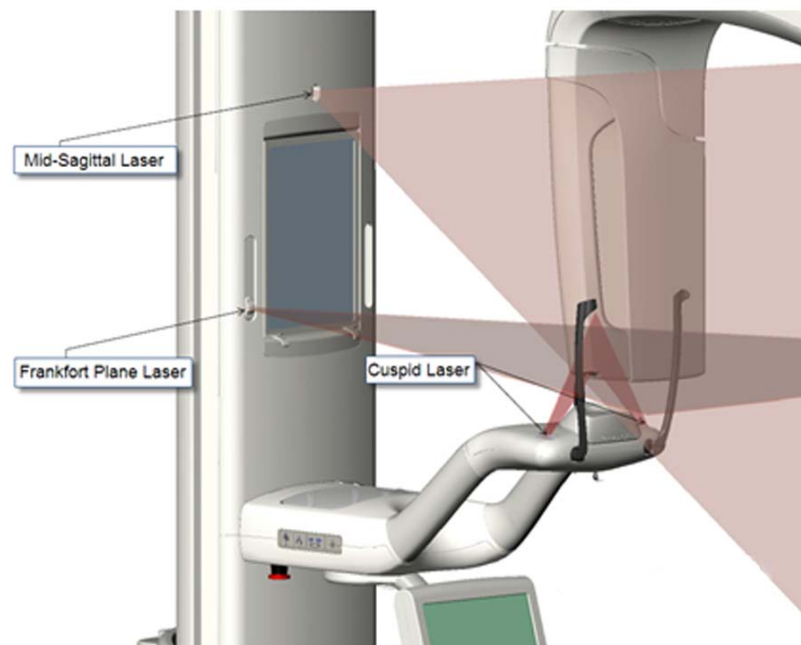

Cuspid Laser Adjustment

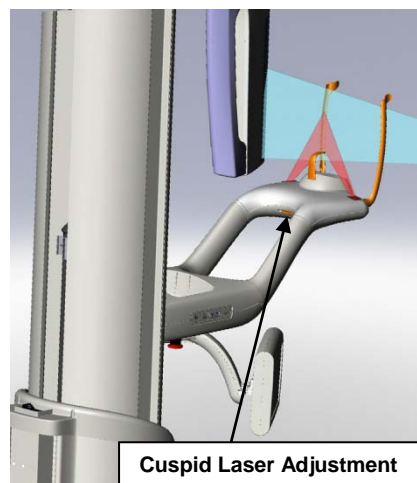

Frankfort Plane Laser

The Frankfort plane laser is used to align the horizontal tilt of the patient's head. A slider button on the front of the telescoping column moves the laser.

Frankfort Plane Laser Slider Button

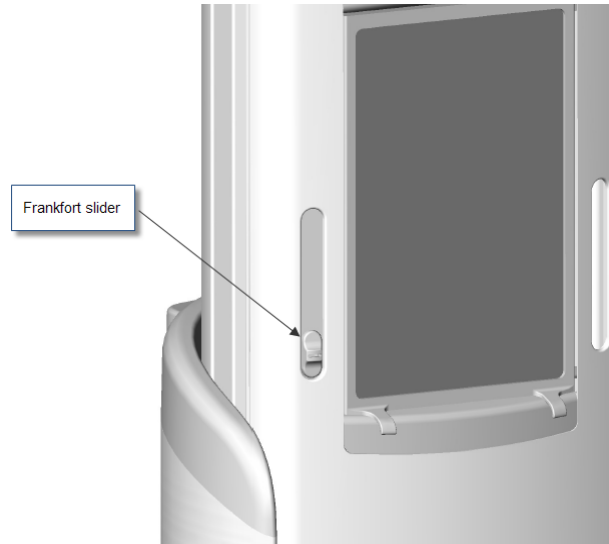

The illustration, Alignment with the Frankfort Plane Laser, is an example of the positioning of the Frankfort Plane laser on the patient's head.

Alignment with the Frankfort Plane Laser



This laser is used to align the patient's head.

Mid-Sagittal Laser

The mid-Sagittal laser is used to center the patient on the patient positioning table. It is a fixed laser.

Alignment with the Mid-Sagittal Laser

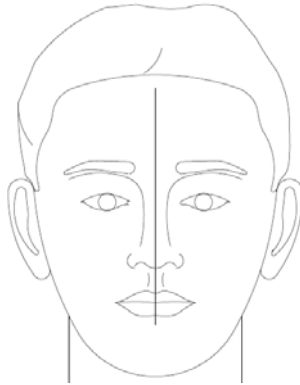

Cuspid Laser

The Cuspid laser is used to align the focal trough, the area most sharply defined on the X-ray. You use the adjustment knob under the patient positioning table to move the Cuspid laser to the proper alignment.

Alignment with the Cuspid Laser

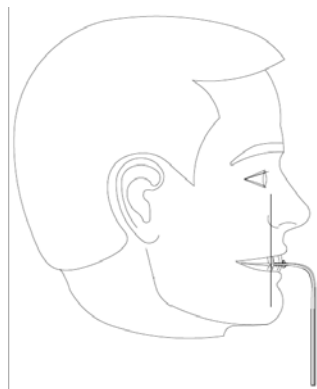

Cephalometric Positioning Tools

Having the patient correctly positioned for a Cephalometric X-ray is extremely important for the quality of the image.

The Progeny Vantage Cephalometric X-ray System has built-in tools that make correct positioning quick and easy to accomplish. These tools include:

- control buttons for column height
- Easy to use, and comfortable Cephalostat

Control Buttons for Column Height

The telescoping column of the Vantage System supports the Cephalometric assembly from which the Cephalostat depends. The height of this column and the Cephalostat is easily adjusted from the positioning controls on the Secondary Collimator, or from the Positioning Control Button panel located on the side of the patient positioning table.

Cephalostat

The cephalostat has three distinct functions. First, the cephalostat as a whole can be rotated to identify the type of cephalometric projection desired (lateral left or right, AP, and PA). Secondly, the otic posts are a gentle positioning aid to help keep the patient in the proper, stationary position during the examination. Finally, a nasion marker is provided to aid the location of this soft tissue area on resulting radiographs (a ruler is also embedded in the marker for measurement purposes).

Entry and Exit, and Ready for Imaging Positions

The overhead arm on the Vantage System has an entry, exit, and ready for imaging position.

- In the entry position, the overhead arm is nearly centered to the patient table to allow the patient to enter the Vantage System.
- In the exit position, the overhead arm is slightly off to the side of the patient positioning table to allow the patient to exit the Vantage System.
- In the Ready for Imaging position, the overhead arm is close to the patient positioning table and ready to begin image acquisition.

Status Indicator

The Status Indicator is color-coded for the position of the overhead arm. When **Ready** is yellow, the Vantage System is in the entry position. When **Ready** is gray, the Vantage System is in the exit position. When **Ready** is green, the Vantage System is ready for imaging. When **Ready** is red, the system is in an unknown position, as at initial power up, and moving to find the home position.

Demo Mode

The Demo mode allows the operator to simulate the movement of the Vantage System as it runs through an actual imaging cycle. No X-ray image is taken during the demo. Using the Demo mode helps patients see how the Vantage System moves, and what to expect during the actual acquisition of an image. This in turn may allow the patient to be more at ease during the X-ray and to move less, thereby increasing the likelihood of a good image, and a lower level of X-ray exposure.

For a patient who is fearful of the process, you might ask the patient to stand back from the Vantage System and watch as it simulates an X-ray. For most patients, you can run the Demo mode after you have positioned them for their X-ray, just before you initiate the X-ray.

6 Preparing to Receive the Image

In this Chapter

- About Imaging Software
- Using Progeny Imaging Software
- Using Other Software

About Imaging Software

The imaging software, running on the workstation, is used to view and store the images made using the Progeny Vantage Panoramic X-ray System. The imaging software also provides the Vantage Panoramic X-ray System with patient name and practice name.

There are several types of imaging software. In this manual, Progeny Imaging software and Progeny TWAIN software are addressed. If different imaging software is used, consult the manual that came with the software to make full use of its capabilities.

Using Progeny Imaging Software

Follow the steps below to use the Progeny Imaging software.

1. Open the Progeny Imaging software.

Progeny Imaging Icon



- When the Login - Progeny Imaging screen appears, enter your username and password, and then click the Login button.

Progeny Imaging Login Screen

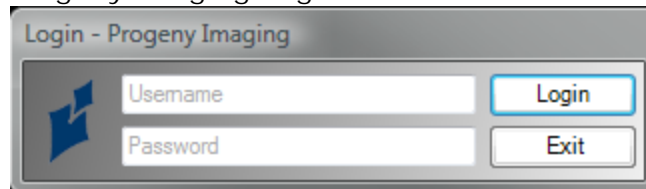

- Select "Default Pan" in the device selection box at the top of the screen.

Progeny Imaging Screen - Device Selection



- To display the list of patients, click Patient > Open from the menu at the top.

Progeny Imaging Screen - Open the Patient List

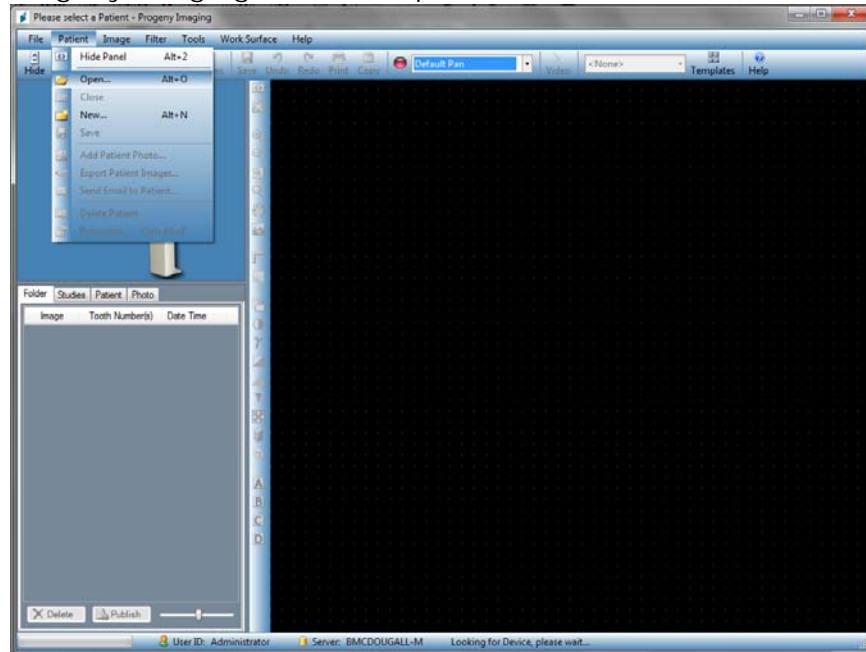

5. On the Select Patient screen, select the patient, and then click the Open button. The patient information appears on the workstation and the Touch Control panel.

Progeny Imaging Screen – Select a Patient

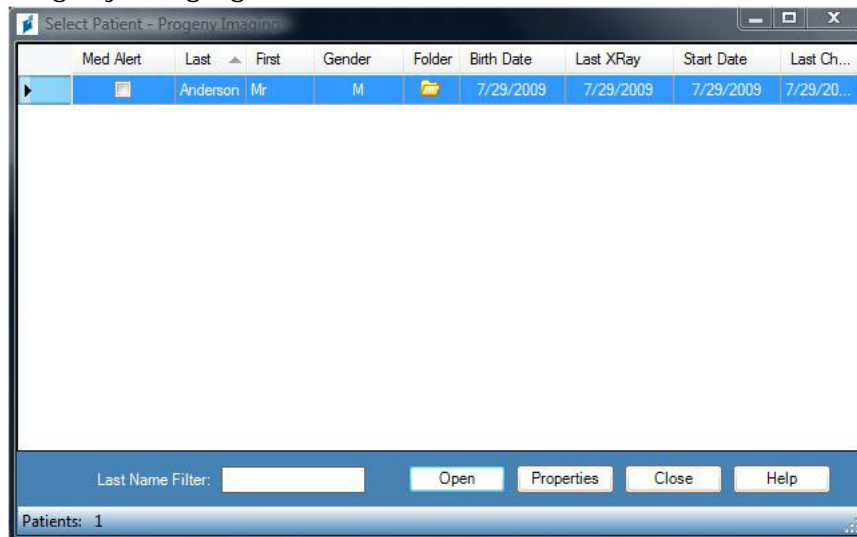

6. Follow the Vantage procedures to position the patient and acquire an image.

Using Other Software

The Progeny Vantage Panoramic X-ray System can also interface with other imaging and practice management software using the Progeny TWAIN interface.

1. Open the TWAIN option in the software being used, and choose the Progeny TWAIN device. The Progeny TWAIN window appears.

Progeny TWAIN Screen

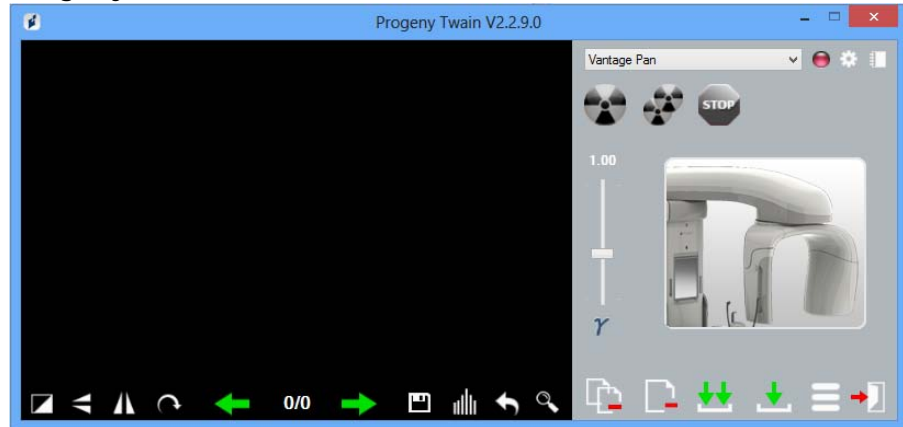

2. Select the device "Progeny Vantage Pan" from the device dropdown menu.

Progeny TWAIN Screen - Select a Device



3. To view image information, click the yellow notepad button. The Notes window appears.

Progeny TWAIN Notes Screen

**Note:**

Image technique information appears in the window. The patient name can be entered for reference in the TWAIN application, but it is not passed on to the imaging application.

4. Enter image information, such as patient name, and then click the Close button when finished.
5. Follow the Vantage procedures to position the patient and acquire an image.
6. After acquiring an image, return to the Progeny TWAIN window.

Progeny TWAIN Screen with Transfer Buttons

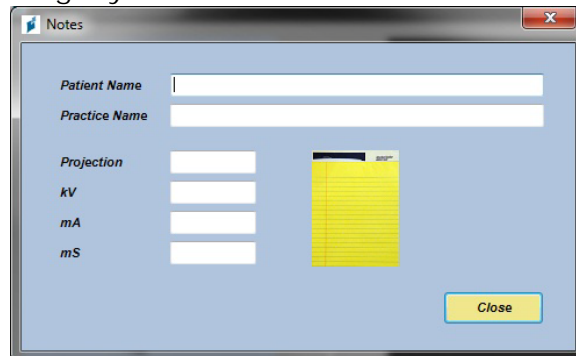
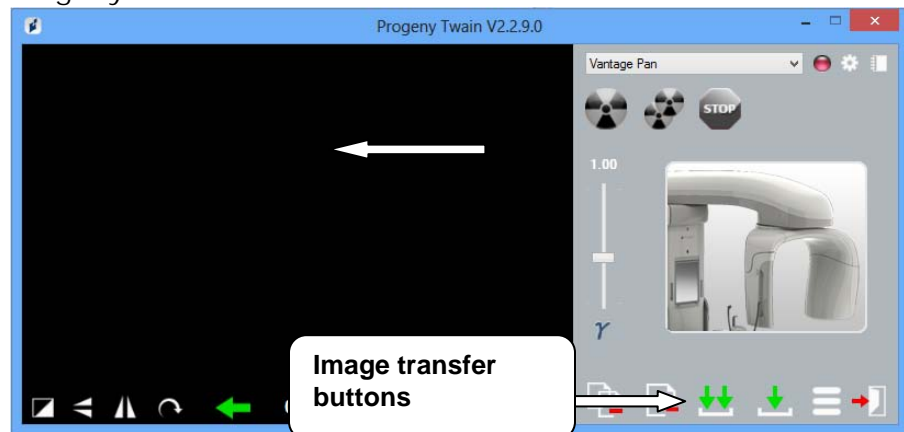

7. Use the Transfer buttons to download images to the 3rd party software.
 - Transfer - downloads the last acquired image.
 - Transfer All - downloads all newly acquired images.

7 Getting Started

In this Chapter

- Turning the Vantage System On
- Setting the Technique Factors
- Configuring Device Options
- Configuring the Touch Control Panel
- Calibrating the Touch Control Panel

Turning the Vantage System On

1. To turn on the Vantage panoramic device, press the On/Off switch located at the back of the stationary column on top of the box of connections.

Vantage Panoramic Device with On/Off switch

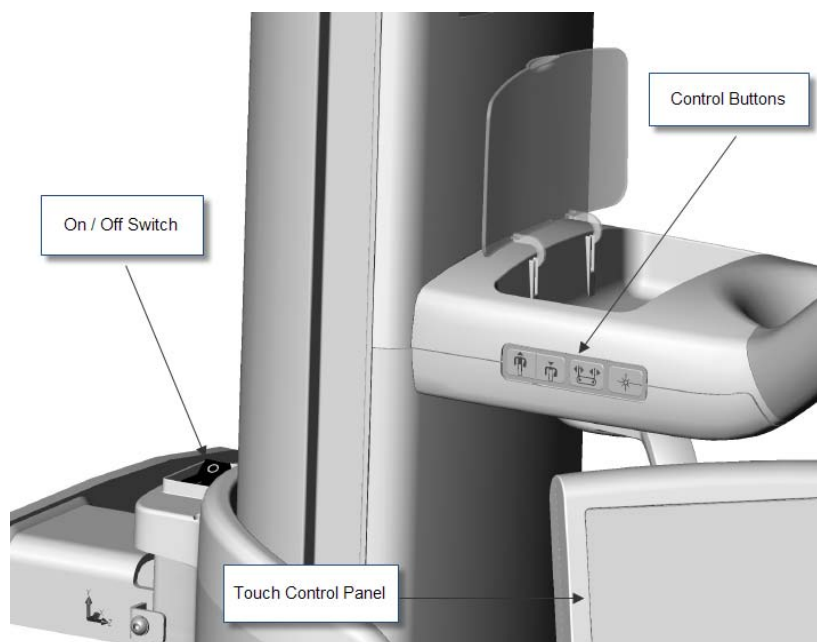

When you turn on the Vantage panoramic device, the Touch Control panel displays a “Start Up” screen. The Vantage panoramic device goes through a self diagnostic procedure as part of the startup process.

Setting the Technique Factors

The technique factors are the exposure factors, defining the intensity and duration of the X-ray. The technique factors are the projection type, segmentation, patient and jaw sizes, and kiloVolt (kV) and milliAmpere (mA) values. You set the technique factors on the Acquisition Setup screen. *For more information, see the Acquisition Setup screen in Chapter 5.*

Projection Type

Select one of four projections: Pan Standard, Pan Enhanced, Pan Bitewing or TMJ. The method of selection (tap or slide) is set using the Slide On/Off button on the Options screen. *For more information, see the Options screen in Chapter 5.*

1. Select the Projection icon until the desired projection type appears.

Pan Standard Projection Icon

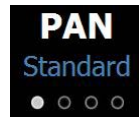

2. To view a different projection type, select the icon again.
3. For a Pan Pediatric (Pedo) projection, select Pan Standard projection and then select the Child patient size.

Segmentation

By default, the Vantage System images the entire jaw. To select specific areas to image, you use the segment panels or the projection types, which automatically select segments. The method of selection (tap or slide) is set using the Slide On/Off button on the Options screen. *For more information, see the Options screen in Chapter 5.*

1. To turn a segment panel off, simply select any segment. The segment turns dark to indicate it is not selected.
2. Select the segment again to turn it back on.

Segmentation Panel

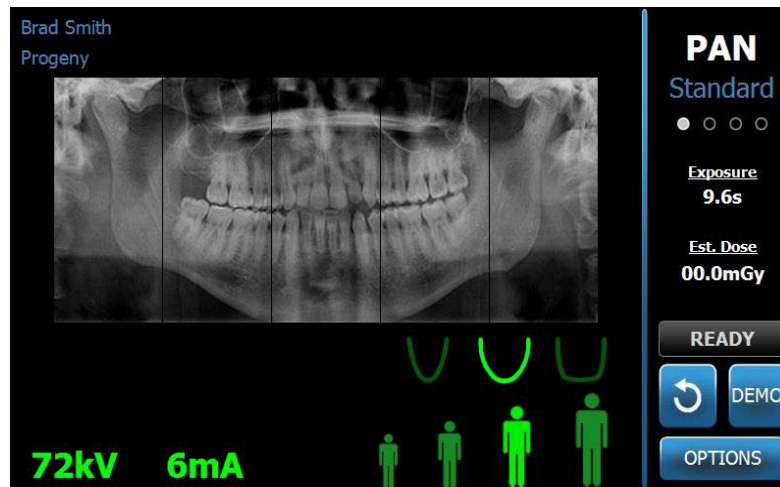

Patient Size

The patient sizes are Child, Small Adult, Adult, and Large Adult. Adult is the default patient size. Changing the Patient size sets the kV and mA values to the default setting for that patient size, as defined on the Profile Properties screen. *For more information, see Profile Properties Screen in Chapter 5.*

1. To change from Adult, simply tap the desired icon.
2. To select the Child patient size, tap the smallest patient size.
By default, the jaw size changes to “Narrow” to indicate that the width of the exposed area will be reduced.

Patient Size Icon



Jaw Size

The jaw size is dependent on the patient size and the settings from the Profile Properties screen. *For more information, see the Acquisition Setup screen and the Profile Properties Screen, both in Chapter 5.*

Jaw Size Icon



1. To select the jaw size, tap the corresponding icon for Narrow, Normal, and Wide jaw sizes.
The selected jaw size turns bright green.
2. If you change the patient size after selecting a jaw size, the jaw size may change as well. Simply reselect the correct jaw size for the new patient size.

kV and mA Values

All kV values quoted in this manual are peak values. You can increase or decrease kV and mA values up to their maximum values as defined on the kV and mA Properties screen. A default value is green and changes to yellow to indicate the value is no longer the default value.

kV and mA Icon



1. To change a value, tap the kV value or the mA value. Up and down arrows appear above the value selected.
2. Tap the up or down arrow as often as needed to reach the desired value.

The Default kV and mA Values table identifies initial values used with the Progeny Vantage Panoramic X-ray System.

Default kV and mA Values

| Patient Size | Default Values | |
|--------------|----------------|----------|
| | kV Value | mA Value |
| Child | 66 | 8 |
| Small Adult | 70 | 10 |
| Adult | 74 | 10 |
| Large adult | 78 | 10 |

If any of the following conditions apply, you may wish to consider adjusting the kV and mA peak values:

- If the patient has heavy soft tissue and/or bone structure about the face and neck, use the next higher kV and/or mA setting.
- If the patient is small and has narrow facial bone structure, use the next lower kV and/or mA setting.
- If the patient is edentulous, use the next lower kV and/or mA setting.

Configuring Device Options

The Profile Properties screen allows you to change default settings for the patient.

1. On the Options screen, tap the Profile Properties button. The Profile Properties screen appears.

Profile Properties Screen

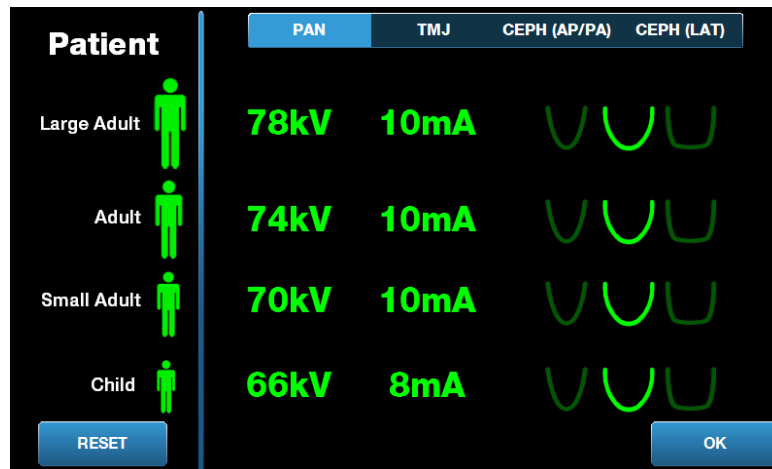

2. Tap Pan, TMJ CEPH (AP/PA) or CEPH (LAT).
3. For each patient size to be changed, tap the appropriate patient icon.
4. To modify a default kV and/or mA value, tap the value and adjust it using the up/down arrows.
5. When setting Pan defaults, tap a different jaw profile for the patient.
6. When finished, tap the OK button to save the changes, or tap Reset to return to the previous default values.

Configuring the Touch Control Panel

The Touch Control panel is configured and calibrated, and ready to use upon arrival. You may want to refine the configuration for the following options: Click sound, Language, Audio Level, Touch Calibration, and Slide on/off.

1. Tap the Options button on the Acquisition Setup screen, and the Options screen appears.

Options Screen

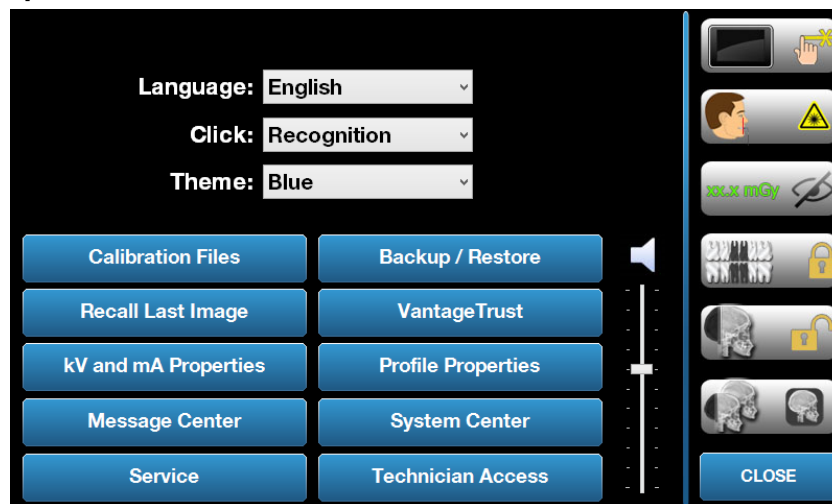

2. To change the sound, tap anywhere on the Click field and select a sound from the dropdown menu.
3. To change the language, tap anywhere on the Language field and select a language other than English, the default.
4. To adjust the volume, drag the Audio Level slider button left or right to the proper volume.
5. To calibrate the Touch Control panel, tap the Touch Calibration and follow the on-screen instructions.
6. To toggle the Slide on/off, click the circle icon with a hand in it.
7. Click the Close button to return to the Acquisition Setup screen.

8 Positioning the Patient

In this Chapter

- About Patient Positioning and Image Quality
- Preparing the Patient
- Setting the Height of the Vantage System
- Inserting the Chin Rest and Bite Guide
- Inserting the TMJ Positioner
- Adjusting the Positioning Wands
- Using the Positioning Lasers
- Cephalometric Positioning (Option)
- Using the Demo Mode

About Patient Positioning and Image Quality

Having the patient correctly positioned for a panoramic X-ray is extremely important for the quality of the image. The patient's positioning relative to the focal trough (the area of sharpest definition) determines the quality of the resulting image.

The Vantage System enables you to position patients quickly and easily with its up/down buttons, chin rest, positioning wands, and precision positioning lasers.

Preparing the Patient

1. Describe to the patient what needs to occur to acquire a successful image. Include an overview of the imaging process, and what you will be asking the patient to do.
2. Ask the patient if they would like you to run the Demo, a simulation of the imaging process.
3. Request that the patient remove earrings, eye glasses, and mouth or facial piercings, as well as a jacket or bulky sweater while you prepare the Vantage System and set technique factors.

Setting the Height of the Vantage System

You adjust the height of the patient positioning table so that the chin rest is approximately the same height as the patient's chin.

Patient Positioning Table

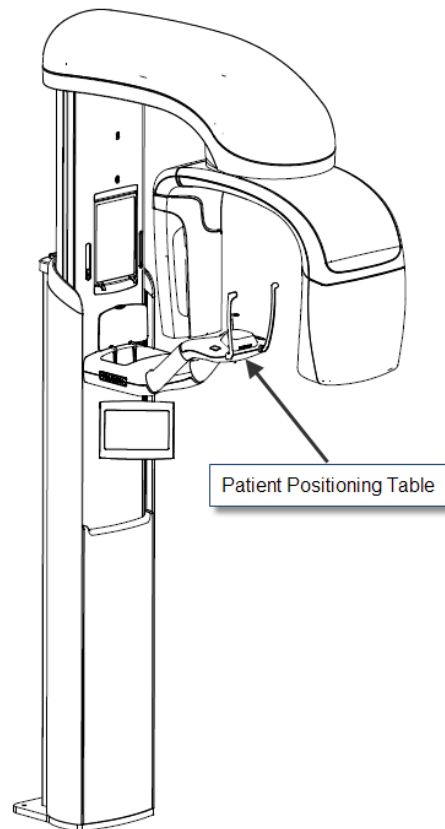

1. Visually compare the height of the patient's chin with the chin rest on the patient positioning table.
2. Using the up/down control buttons on the side of the patient positioning table, adjust the height of the Vantage System until the cup of the chin rest is approximately level with the patient's mouth.

Tip The vertical column moves slowly at first, and then faster.

Up/Down Control Buttons



Inserting the Chin Rest and Bite Guide

The chin rest and bite guide are used to position a patient for all Pan Standard, Pan Enhanced, and Pan Pedo projections.

1. Mount the chin rest on the patient positioning table.
2. Insert the bite guide into the slot at the back of the chin rest. The bite guide aligns the jaws front to rear.
3. Install a sheath on the bite guide prior to patient positioning.
4. Slowly, using the up/down control buttons, raise the Vantage System until the cup of the chin rest is approximately level with the patient's mouth.
5. Ask the patient to step forward to the Vantage System, grasp the handles and put their chin in the chin rest.

Chin Rest and Bite Guide Positioning



6. Ask the patient to gently bite down on the protective sheath covering the bite guide. Make sure the teeth are located between the ridges of the bite guide.

Teeth Positioning on the Bite Guide

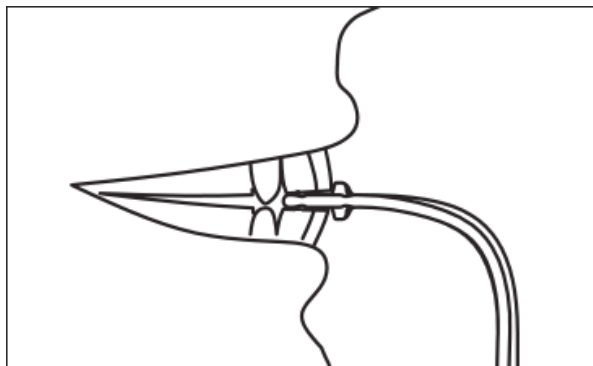

Removing the Chin Rest and Bite Guide

When removing the chin rest and bite guide, the bite guide must be removed first by pulling upward. Then the chin rest may be lifted out of the Positioning Table.

Inserting the TMJ Positioner

The TMJ positioner is used to position a patient for TMJ projections. All other steps for positioning the patient are the same as for other projections.

1. Replace the chin rest and bite guide on the patient positioning table with the TMJ positioner.

TMJ Positioner



TMJ Positioner Mounted on the Patient Positioning Table

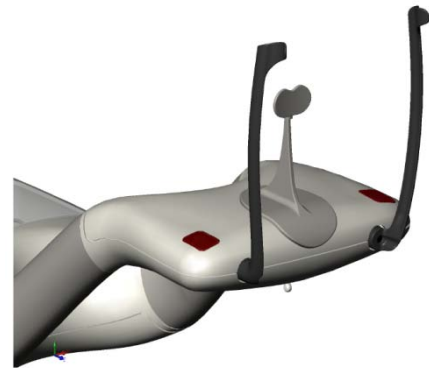

2. Slowly, using the up/down control buttons, raise the Vantage System until the TMJ positioner is approximately level with the patient's mouth.
3. Install a sheath on the TMJ positioner prior to patient positioning.
4. Ask the patient to step forward to the Vantage System and grasp the handles.
5. Position the patient so the TMJ positioner presses against the upper lip at the base of the nose.

Adjusting the Positioning Wands

1. Press the open and close wand button to move the wands in and out from the patient's head. The button is on the Button Control panel, shown here.

Open and Close Wands Button

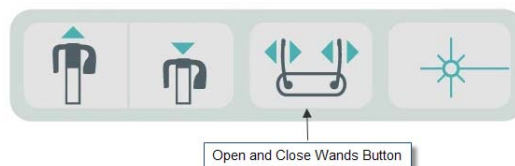

2. Press the button until the wands rest firmly on the patient's head in the temple area.

Using the Positioning Lasers

The Progeny Vantage Panoramic X-ray System has three lasers to help position the patient: Frankfort laser, mid-Sagittal laser, and Cuspid laser.

Positioning Lasers

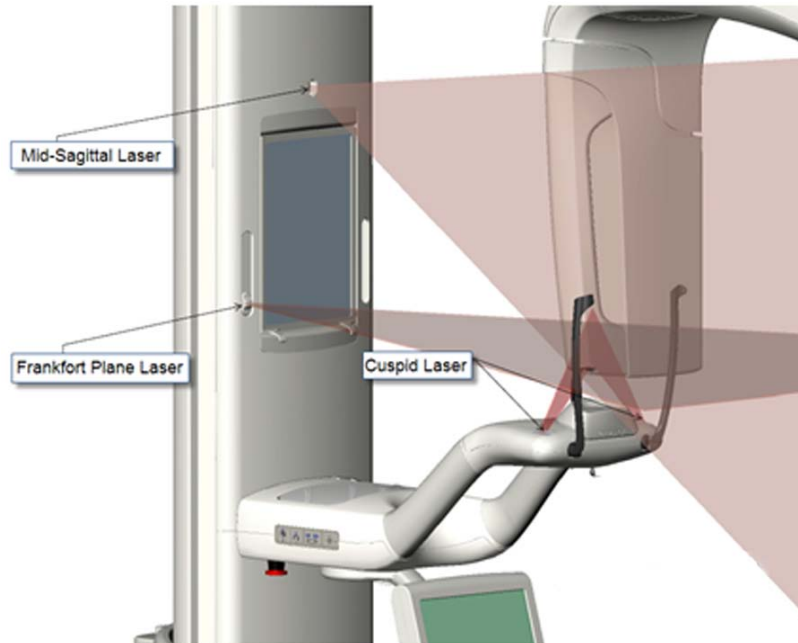

Cuspid Laser Adjustment

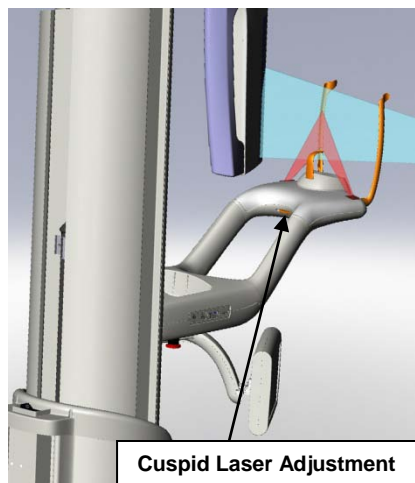

1. Turn on the positioning lasers using the laser on/off button on the patient positioning table.

Positioning Laser On/Off Button



CAUTION! Class 2 Laser radiation. Do not stare into the beam. 650 nm, 3 mW

2. Have the patient grasp the handles on the patient positioning table and step forward.

Mid-Sagittal Laser

To properly center the patient, use the fixed mid-Sagittal laser to check the lateral positioning of the patient.

1. Make sure the teeth are located between the ridges of the bite guide to ensure the jaws are aligned front to rear and side to side.
2. Center the laser beam on the bridge of the nose so it passes through the center of the upper lip.
3. If the laser is not centered, gently move the patient's head until it is centered.

Mid-Sagittal Laser

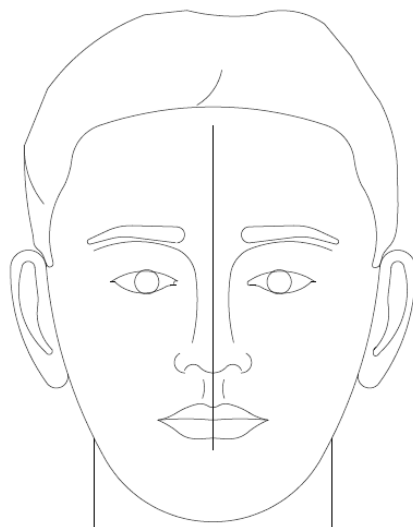

Frankfort Plane Laser

To properly align the tilt of the patient's head, two types of adjustments are needed.

- The Frankfort slider button moves the laser up and down on the patient's head to align with the external auditory meatus.
- The up and down control buttons raise and lower the patient positioning table and adjust the tilt of the patient's head and align with the bottom of the optical orbit.

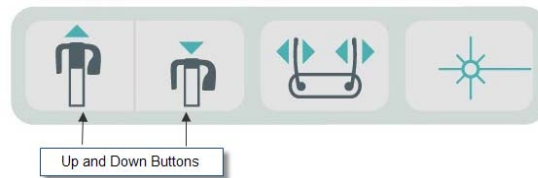

1. Align the laser with the external auditory meatus by moving the Frankfort Plane slider button up and down on the vertical column.
2. Use the up and down control buttons to align the lower part of the optical orbit with the Frankfort Plane laser. See the Frankfort Plane Laser illustration that follows.

Frankfort Plane Laser

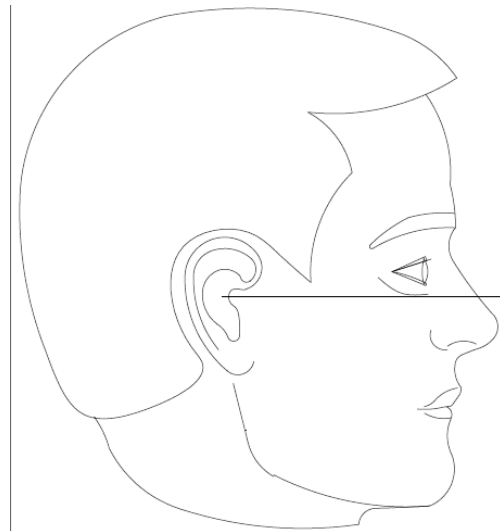

Cuspid Laser

The Cuspid laser helps to align the focal trough.

1. Make sure the teeth are located between the ridges of the bite guide to ensure the jaws are aligned front to rear and side to side.
2. Move the adjustment knob under the patient positioning table until the laser beam aligns with the anterior edge of the Cuspid teeth.
3. Have the patient smile. See the Cuspid Laser illustration that follows.

Cuspid Laser

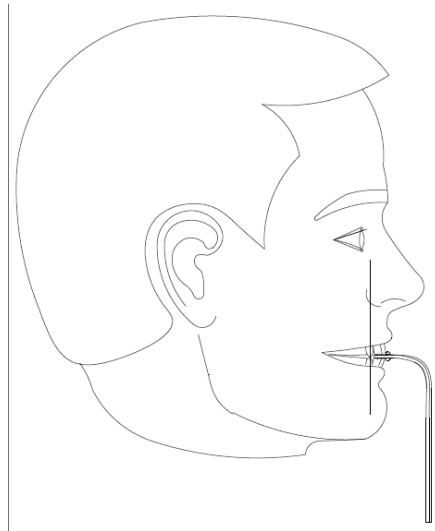

Positioning an Edentulous Patient

1. Use TMJ positioner to locate the patient.
2. Place cotton rolls between the anterior gums to space the jaws.
3. Line the Cuspid laser up slightly to the rear of the upper anterior gum line.

Cephalometric Positioning (Option)

The same general instructions at the beginning of this Chapter apply to cephalometric positioning. The patient should be placed in a comfortable standing position close to the cephalostat device.

Setting the Height of the Vantage System

Adjust the height of the cephalostat until the ear posts are approximately the height of the patient's otic canal.

Cephalostat

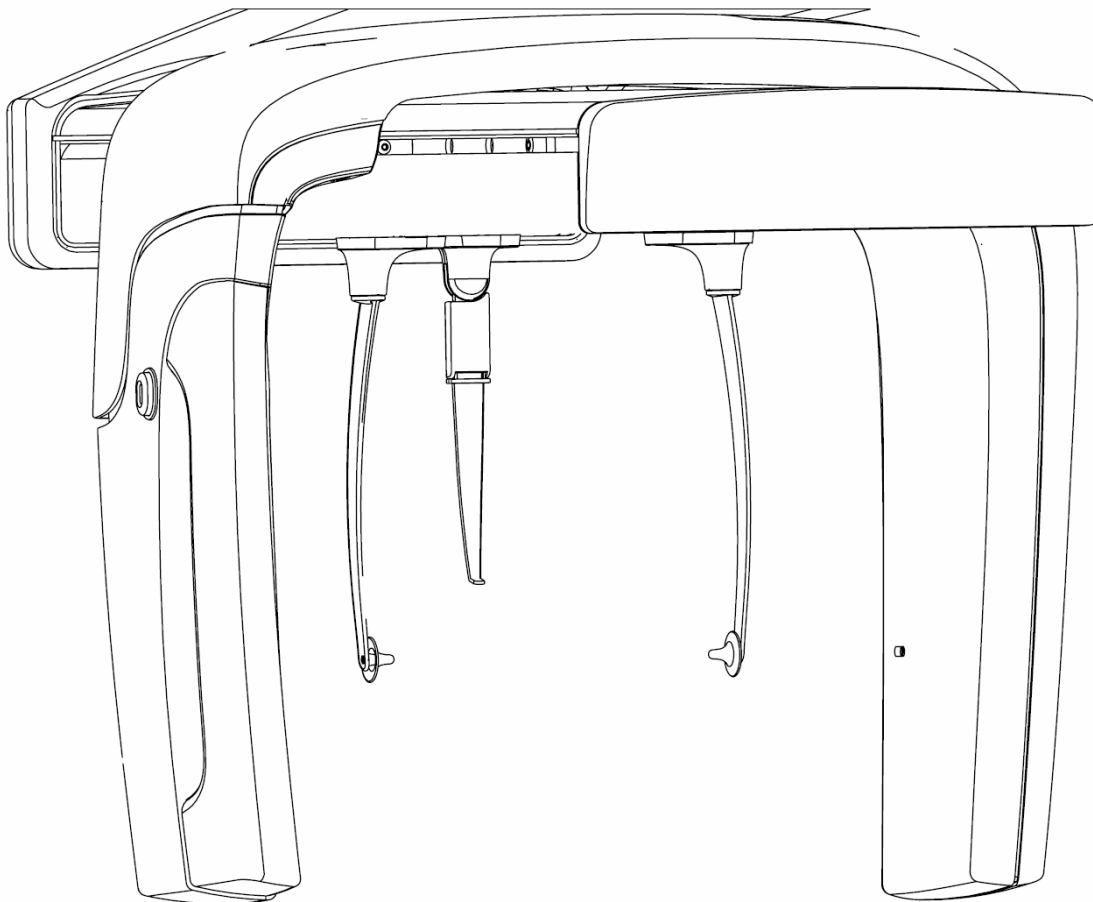

1. Visually compare the height of the patient's otic canal with the cephalostat ear posts.

- Using the up/down control buttons on the secondary collimator, or on the side of the patient positioning table, adjust the height of the Vantage System until the ear posts are approximately level with the patient's otic canal.

Tip The vertical column moves slowly at first, and then faster.

Up/Down Control Buttons

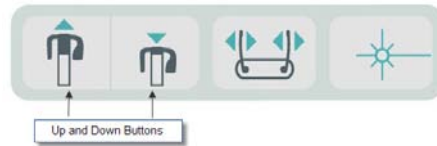

Adjusting the Otic Posts and Nasion

- Grasp one of the Otic Posts at the top and move it in or out as needed to position or release the patient. Both posts will move together. The posts are designed so that they will not move except when grasped at the top.
- Grasp the Nasion and slide it vertically until it aligns with the bridge of the patient's nose. Slide the Nasion toward the patient's nose until the tip contacts the bridge of the nose. For projections where the Nasion is not needed it will rotate about the base out of projection area.

Review Patient Head Orientation

- The patient's head position should be reviewed to make sure it is correct along 3 axes:
 - From a side lateral view, the Frankfort plane (bottom of orbit to Otic Posts) should be level horizontally.
 - From a frontal view, the patient's face should be straight forward, without any twisting.
 - Also from the front, ensure the patient's head is not tilted, but vertically straight.

AP/PA Projection

The AP/PA projection is achieved with the cephalostat positioned with the nasion toward the tubehead (AP), or opposite the tubehead (PA).

- Rotate the Nasion marker up
- Rotate the cephalostat into the PA position
- Place the patient within the cephalostat
- Make sure the Frankfort Plane is level
- Ask the patient to close the mouth

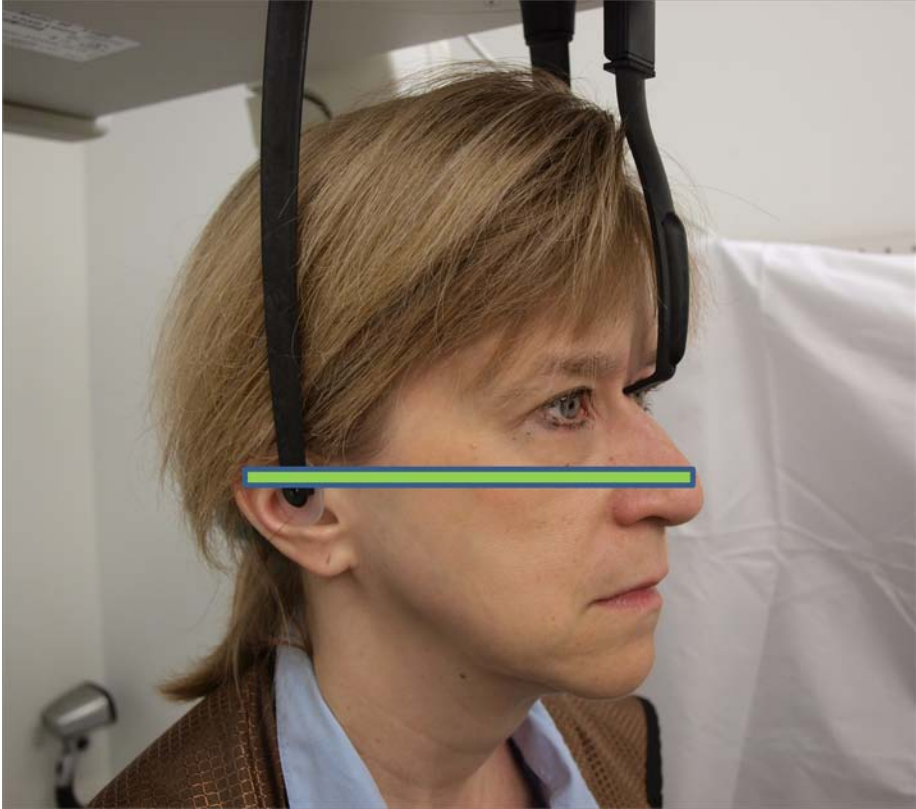

Lateral Projection

The Lateral projection is achieved with the cephalostat positioned with the Otic posts in line with the x-ray tube head.

- Rotate the Nasion marker up
- Rotate the cephalostat in the Lateral position
- Place the patient within the cephalostat
- Make sure the Frankfort Plane is level
- Move the Nasion marker tip to the patients nasion
- Ask the patient to close the mouth

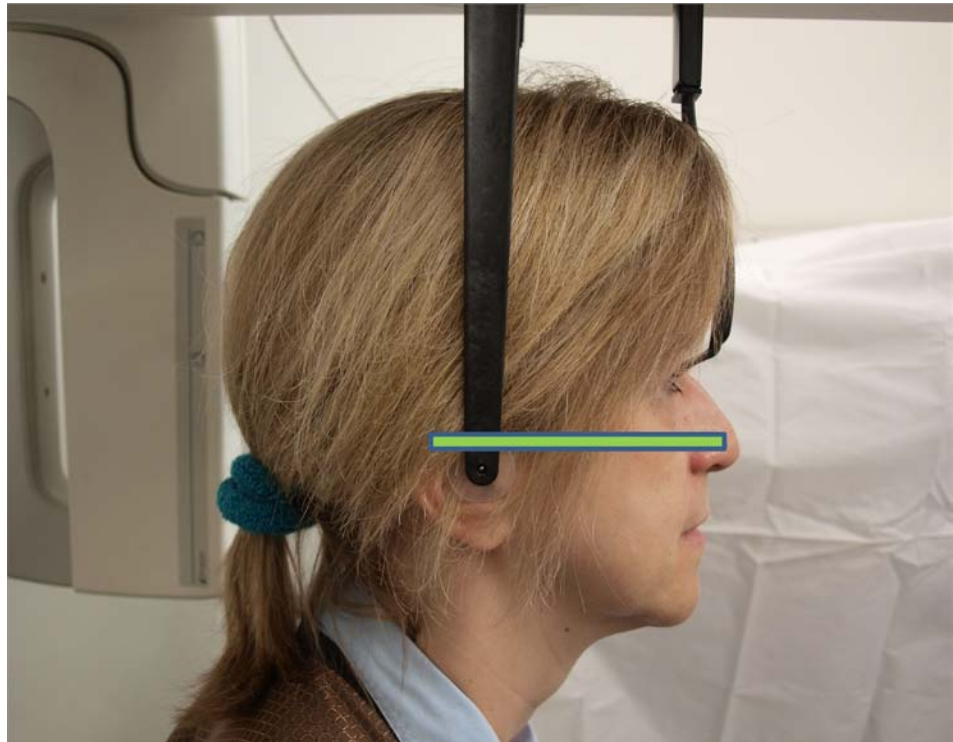

Using the Demo Mode

The Demo mode allows demonstration of device function without emission of radiation. Demo mode is activated using the Demo button on the Acquisition Setup screen on the Touch Control panel. When the sensor is not connected, the system automatically enters Demo mode.

1. On the Acquisition Setup screen of the Touch Control panel, tap the Demo button.

Acquisition Setup screen showing Demo Button



2. Tap the Demo button again to return to the image acquisition mode.

9 Acquiring a Panoramic Image

In this Chapter

- Acquiring an Image

Acquiring an Image

1. Make sure the Vantage System is in the Patient Entry position. If not, tap the Ready for Imaging button on the Touch Control Panel Acquisition Setup screen.
2. Verify the correct patient name appears at the top left of the Acquisition Setup screen.

Acquisition Setup screen

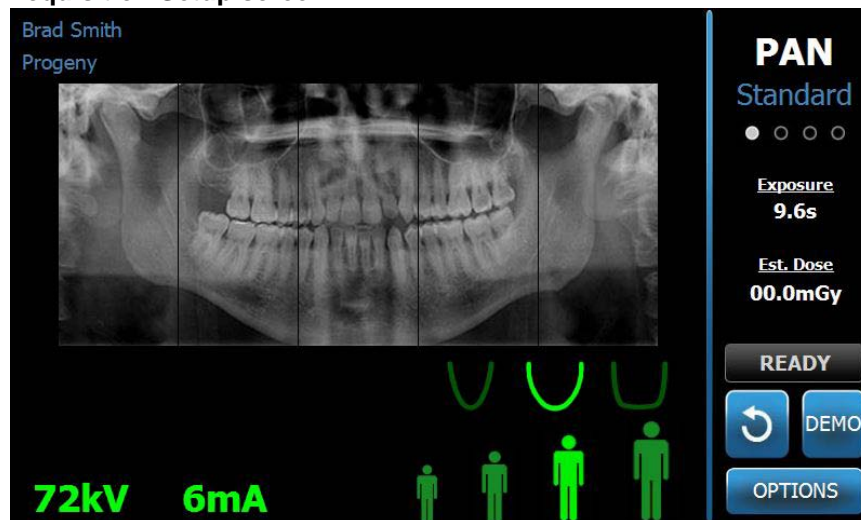

3. Adjust the height of the Vantage System to the approximate height for the patient using the up/down control buttons on the side of the patient control table.
4. Select the technique factors. *For more information, see Setting the Technique Factors in Chapter 6.*
5. Position the patient. Use the steps and information in "Positioning the Patient".
6. If the patient requested an X-ray simulation, tap the Demo button on the Acquisition Setup screen. When Demo mode is active, position the patient (if desired), and proceed as if an actual image is being taken. When done, tap Demo again to turn off the Demo mode.

7. After the patient is properly positioned, request that the patient swallow, place their tongue on the roof of their mouth, and remain as motionless as possible until the device stops moving and the audio signal sounds.
8. To begin image acquisition, tap the Ready for Imaging button on the Touch Control panel.
The status indicator flashes "WAIT" to indicate a moving status while the Vantage System moves to the ready position.

Ready for Imaging Button



9. Step back at least 2 m (6 ft.), and press and hold the exposure button until the Vantage System stops moving.

Exposure Control Button



10. When the Image Preview appears on the Touch Control panel, verify the image acquired is the one desired for the patient.

Image Preview Screen



11. Tap OK to close the image window.
12. Help the patient exit the Vantage System.

Early Release of the Exposure Button

If the exposure button is released before the Vantage System stops moving, this message appears: "Procedure was interrupted before completion."

1. Click OK on the Message window and wait for Vantage System to recover and to determine if the Image Preview appears.
2. If it does, verify the accuracy of the image.
3. If there is no image or the displayed one is inaccurate, retake the image.

10 Acquiring a TMJ Image

In this Chapter

- About the TMJ Image
- Acquiring a TMJ Image

About the TMJ Image

The temporomandibular joint (TMJ) image is actually a compilation of two images. One image is acquired with the mouth closed, and one with the mouth open. The order is not important. Either the open mouth or closed mouth image can be done first, but both must be done.

The resulting image, appearing after the second TMJ image is acquired, depicts four image segments, two outer segments and two inner segments. The outer two segments are from the first TMJ image acquired, and the inner two segments are from the second TMJ image acquired.

Acquiring a TMJ Image

Acquiring a TMJ image is very similar to acquiring a pan image, with two differences: the TMJ positioner is used instead of the chin rest, and the actual image acquisition is longer because two images are acquired.

1. Attach the TMJ positioner to the patient positioning table.
2. Make sure the Vantage System is in the Patient Entry position. If not, tap the Ready for Imaging button on the Touch Control Panel Acquisition Setup screen.
3. Verify the correct patient name appears at the top left of the Acquisition Setup screen.

Acquisition Setup Screen

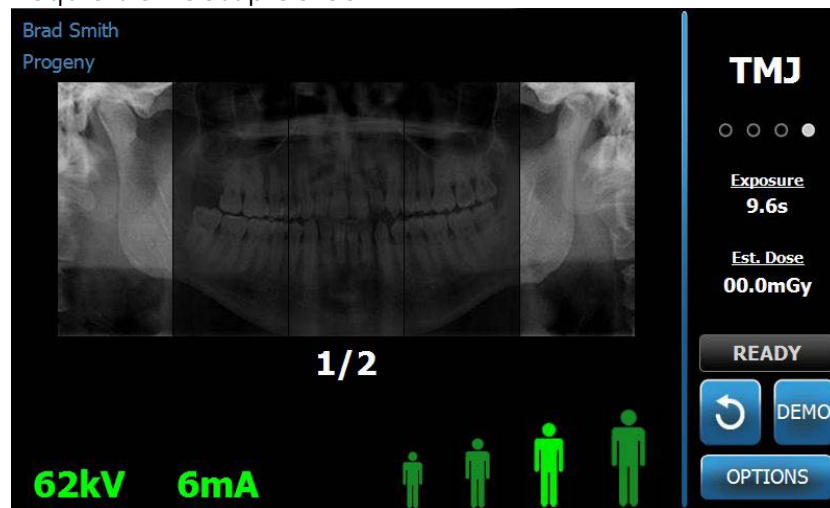

4. Adjust the height of the Vantage System to the approximate height for the patient using the up/down control buttons on the side of the patient control table.
5. When you select the technique factors, be sure to select the TMJ projection. *For more information, see Setting the Technique Factors in Chapter 6.*
6. Position the patient. Use the steps and information in “Positioning the Patient”.
7. If the patient requested an X-ray simulation, tap Demo on the Acquisition Setup screen. When Demo mode is active, position the patient (if desired), and proceed as if an actual image is being taken. When done, tap Demo again to turn off the Demo mode.
8. After the patient is properly positioned, request that the patient remain as motionless as possible until the device stops moving and the audio signal sounds.
9. Remind the patient that two exposures are needed for a TMJ image.
10. To begin image acquisition, tap the Ready for Imaging button on the Touch Control panel.
The status indicator flashes “WAIT” to indicate a moving status while the Vantage System moves to the ready position.

Ready for Imaging Button



11. Step back at least 2 m (6 ft.), and press and hold the exposure button until the Vantage System stops moving.

Exposure Control Button



12. Tap OK to close the image window.
13. Alert the patient that you are taking the second TMJ image. (Note: If you need to cancel the TMJ sequence, press the red "X" on the screen.)
14. Tap the Ready for Imaging button.
15. Step back again at least 2 m (6 ft.), and press and hold the exposure button until the Vantage System stops moving.
16. When the Image Preview appears on the Touch Control panel, verify the image acquired is the one desired for the patient.
17. Tap OK to close the image window. The Cool Down time appears on the Acquisition Setup screen.

Cool Down Time on Acquisition Setup Screen

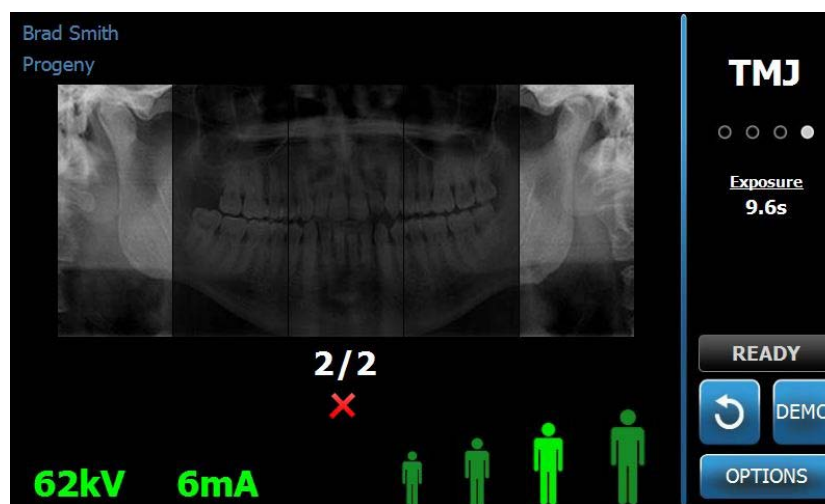

18. Help the patient exit the Vantage System.

Early Release of the Exposure Button

If the exposure button is released before the Vantage System stops moving, this message appears: "Procedure was interrupted before completion."

1. Click OK on the Message window and wait for Vantage System to recover and to determine if the Image Preview appears.
2. If it does, verify the accuracy of the image.
3. If there is no image or the displayed one is inaccurate, retake both TMJ images.

11 Acquiring a Cephalometric Image

In this Chapter

- Acquiring a Cephalometric Image

Acquiring an Image

1. Make sure the Vantage System is in the Patient Entry position. If not, tap the Ready for Imaging button on the Touch Control Panel Acquisition Setup screen.
2. Verify the correct patient name appears at the top left of the Acquisition Setup screen.

Acquisition Setup screen



3. Adjust the height of the Vantage System to the approximate height for the patient using the up/down control buttons on the secondary collimator, or on the side of the patient control table.
4. Select the technique factors. *For more information, see Setting the Technique Factors in Chapter 6.*
5. Position the patient. Use the steps and information in "Positioning the Patient".

6. If the patient requested an X-ray simulation, tap the Demo button on the Acquisition Setup screen. When Demo mode is active, position the patient (if desired), and proceed as if an actual image is being taken. When done, tap Demo again to turn off the Demo mode.
7. After the patient is properly positioned, request that the patient swallow, place their tongue on the roof of their mouth, and remain as motionless as possible until the device stops moving and the audio signal sounds.
8. To begin image acquisition, tap the Ready for Imaging button on the Touch Control panel.
The status indicator flashes "WAIT" to indicate a moving status while the Vantage System moves to the ready position.

Ready for Imaging Button



9. Step back at least 2 m (6 ft.) away from the tubehead but not toward the patient, and press and hold the exposure button until the Vantage System stops moving.

Exposure Control Button



10. When the Image Preview appears on the Touch Control panel, verify the image acquired is the one desired for the patient.

Image Preview Screen

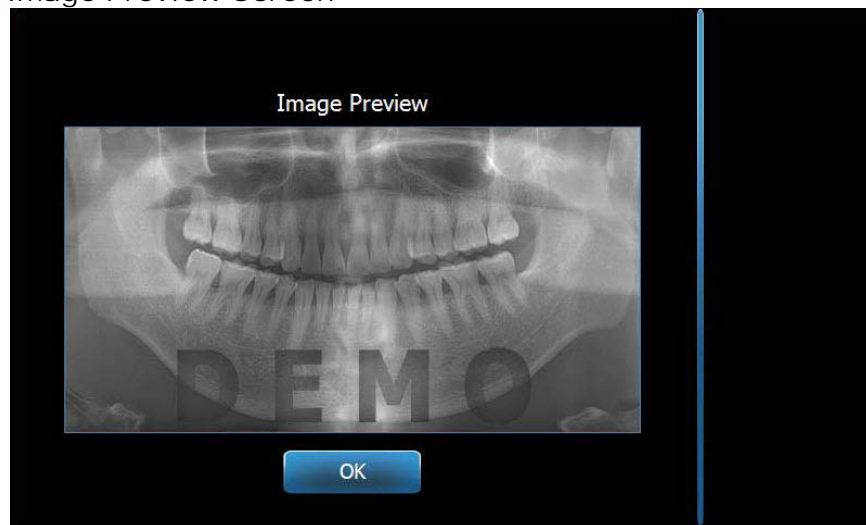

11. Tap OK to close the image window.

12. Help the patient exit the Vantage System.

Early Release of the Exposure Button

If the exposure button is released before the Vantage System stops moving, this message appears: "Procedure was interrupted before completion."

13. Click OK on the Message window and wait for Vantage System to recover and to determine if the Image Preview appears.
14. If it does, verify the accuracy of the image.
15. If there is no image or the displayed one is inaccurate, retake the image.

12 Recalling the Last Image

In this Chapter

- About Image Preview
- Recalling the Last Image

About Image Preview

The Vantage System retains the most recent image acquired in memory until the Vantage System is shut down, or until another image is acquired. Then that image becomes the image in memory. This image can be recalled at any time.

Recalling the Last Image

When you need to retransmit the most recently acquired image, the Recall Last Image button on the Options screen allows you to do this.

1. Tap the Options button on the Acquisition Setup screen, and the Options screen appears.
2. Tap the Recall Last Image button. The Image Preview screen appears.

Recall Image

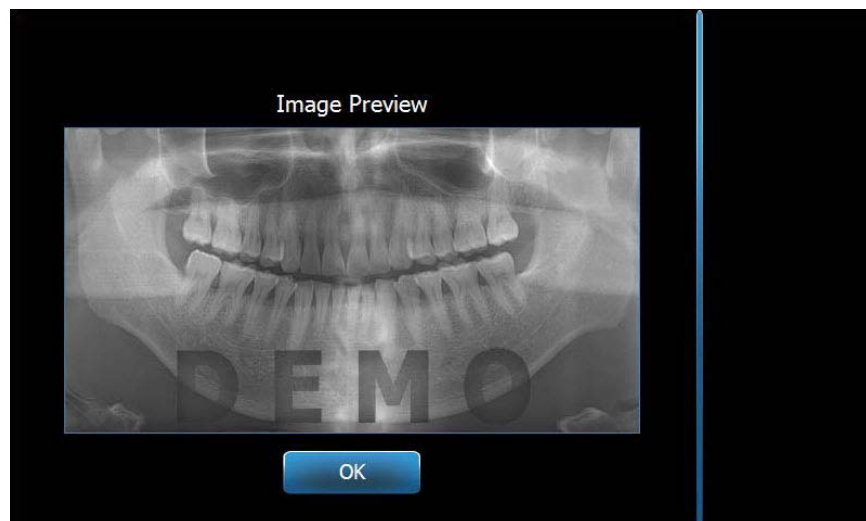

3. When you are finished previewing the image, tap the OK button.

Note

If you just powered on the Vantage System, and you tap the Recall Last Image button, a non-diagnostic image may appear. This image may not be useful for diagnostic purposes.

13 Troubleshooting

In this Chapter

- Characteristics of a Quality Image
- Characteristics of a Quality Cephalometric Image
- Resolving Image Problems

Characteristics of a Quality Panoramic Image

A quality panoramic image will look like the following image, and have the following characteristics:

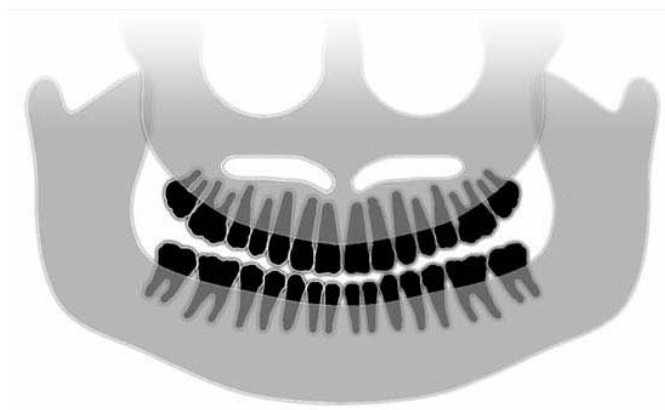

- Symmetry of structures about the midline.
- Slight downward tip of the occlusal plane or smiling appearance.
- Good density, visibility, and sharpness of all structures.
- Spine and ramus ghost artifacts should be minimal.

Characteristics of a Quality Cephalometric Image

The Cephalometric x-ray examination is employed to measure the relationships between intracranial landmarks. These anatomical structures, identified within the radiograph, become one of the components necessary in developing a treatment plan. In order to maximize visibility, the practitioner must verify placement of the Otic Posts and Nasion Locator. During patient positioning, the Midsagittal Line and, Frankfort Plane must be preserved.

Among the landmarks to be visualized, we have:

- Sella (S) – midpoint of the sella turcica
- Nasion (N) – most anterior point of the frontonasal suture
- “A” Point (A) – deepest point on the maxillary profile, between the anterior nasal spine and the alveolar crest
- “B” Point (B) – deepest point on the concavity of the mandibular profile, between the alveolar crest and the point on the chin
- Posterior Nasal Spine (PNS) – the tip of the posterior nasal spine
- Anterior Nasal Spine (ANS) – anterior point of the bony nasal spine
- Gonion (G) – the most posterior, inferior point on the angle of the mandible
- Menton (M) – lowermost point of the mandibular symphysis
- Pogonion (Pog) – most anterior point on the bony chin
- Porion (Po) – the highest point on the bony external acoustic meatus
- Orbitale (Or) – most inferior point of the orbit
- Articulare (Ar) – the point of intersection of the projection of the surface of the condylar neck and the inferior surface of the basi-occiput
- Basion (Ba) – the most posterior inferior point of the midline on the basi- occiput

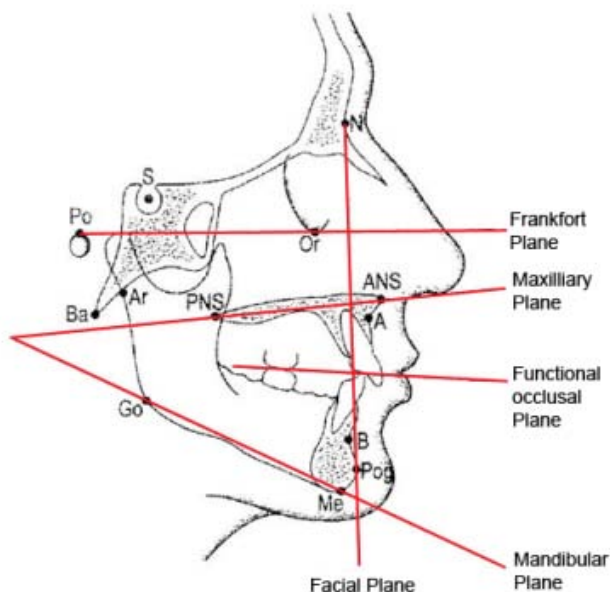

These landmarks are used to develop a visualization of key “Planes” of interest. The planes are identified as:

- The **Frankfort Plane**, which is a line drawn from the Porion to the Orbitale
- The **Facial Plane**, the line between the nasion and the pogonion
- The **Maxillary Plane** – a line from the anterior nasal spine to the posterior nasal spine
- The **Mandibular Plane** - the line between the gonion and the menton
- The **Occlusal Plane** – dental contact surfaces

Several commercially available application programs have been developed to assist the clinician through the process of marking these planes. It is suggested that the clinician become familiar with these and, other anatomical landmarks as the treatment plan and, the anatomy included with the treatment plan, are beyond the scope of this manual.

Resolving Image Problems

The table that follows offers examples of problem images, their characteristics, and steps to take to resolve the problem.

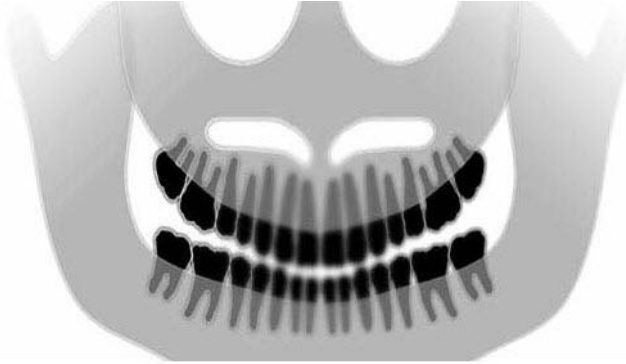
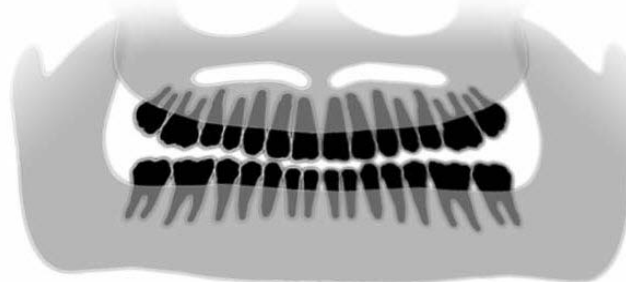
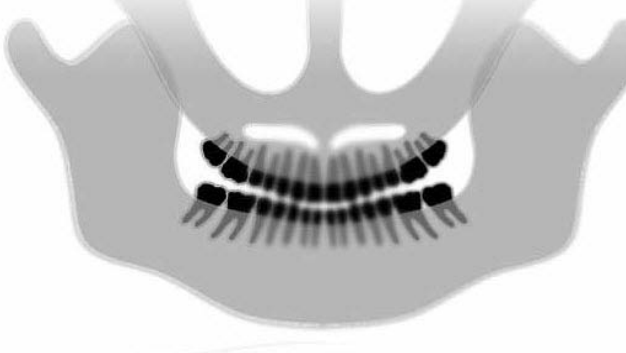
| Problem Images | Characteristics and Solutions |
|---|---|
|  | <p>Identifying Problem Characteristics:</p> <p>Occlusal plane “smile” opens upward</p> <p>Resolving the Problem:</p> <p>Patient’s head is tilted down</p> <p>Use the Frankfort plane laser to properly align the horizontal tilt of the patient’s head.</p> |
|  | <p>Identifying Problem Characteristics:</p> <p>Occlusal plane “smile” opens down. Anterior teeth are above posterior.</p> <p>Resolving the Problem:</p> <p>Patient’s head is tilted upward.</p> <p>Use the Frankfort plane laser to properly align the horizontal tilt of the patient’s head.</p> |
|  | <p>Identifying Problem Characteristics:</p> <p>Anterior teeth are narrow and blurred. Significant spinal image</p> <p>Resolving the Problem:</p> <p>Patient is positioned too far forward.</p> <p>To ensure correct positioning, position the patient with the anterior teeth placed firmly between the ridges of the bite guide.</p> |

Problem Images

Characteristics and Solutions

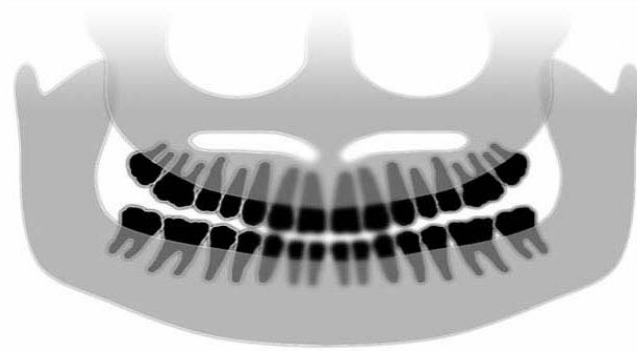

Identifying Problem Characteristics:

Anterior teeth are overly large and blurred.
Condyles may be cut off.

Resolving the Problem:

Patient is positioned too far to the rear.
To ensure correct positioning, position the patient with the anterior teeth placed firmly between the ridges of the bite guide.

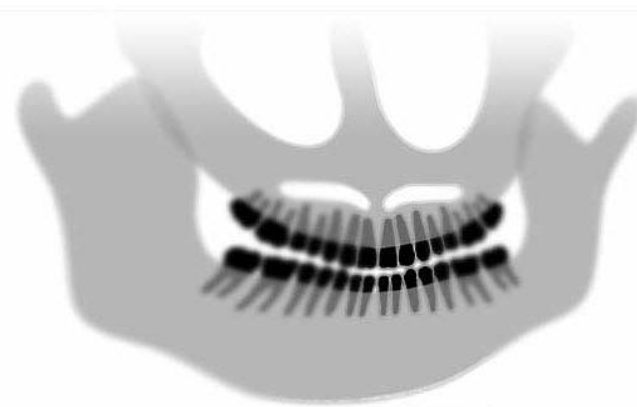

Identifying Problem Characteristics:

Unequal magnification from right to left side.
Patient's right side is too large.

Resolving the Problem:

Patient's head is rotated to the right.
Make sure bite guide is centered on incisors and bite wands are in contact with patient's head. Confirm with mid-Sagittal laser.

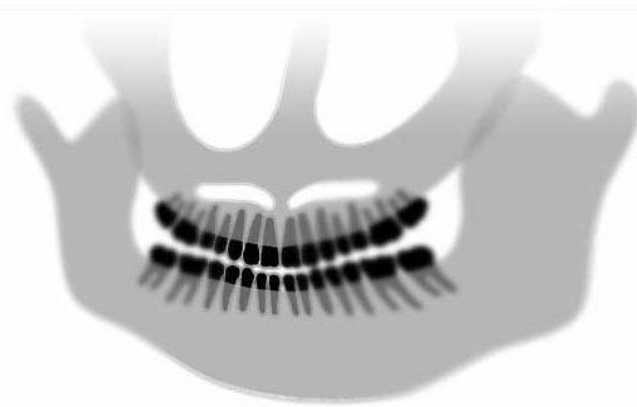

Identifying Problem Characteristics:

Unequal magnification from left to right side.
Patient's left side is too large.

Resolving the Problem:

Patient's head is rotated to the left.
Make sure bite guide is centered on incisors and bite wands are in contact with patient's head. Confirm with mid-Sagittal laser.

Play, looseness in the system

Poor Contrast, Lack of Detail, Fuzzy

General Image Troubleshooting

The diagnostic image must allow the clinician to recognize the required objects of interest. Visualization is accomplished by attention to several factors. Among the significant tools we have are sharpness, brightness (optical density), contrast, and angulation (shape distortion).

Sharpness – Most causes of image unsharpness have been eliminated by the design of the Vantage. The focal spot size has been reduced to the minimum obtainable, the rigid structure dampens vibrations and, the distance between the patient and, the digital sensor has been held to a minimum. In order to reach maximum obtainable sharpness, the patient must remain stationary during the examination and, if possible, suspend respiration.

Brightness (optical density) – Collected images which appear too dark may require an adjustment to the image management program filter settings or, a reduction in the milliampere setting on the x-ray generator. Images which appear too light may require an adjustment to the image management program filter settings or, an increase in the milliampere setting on the x-ray generator.

Contrast - Collected images which present with lower than desired contrast may require an adjustment to the image management program filter settings or, a decrease in the kilovoltage setting on the x-ray generator. Images which present with higher than desired contrast may require an adjustment to the image management program filter settings or, an increase in the kilovoltage setting on the x-ray generator.

Angulation (shape distortion) – As the information collected within the image will appear in a two dimensional format, anatomical landmarks may become superimposed due to poor positioning. In the case of the lateral Cephalometric examination, it will be necessary to verify the concentric alignment of the patient's ear canals. During the review of the PA projection, lateral symmetrical alignment is required. In either case, the Midsagittal Line and, Frankfort Plane must be preserved.

13 Maintenance

In this Chapter

- Regular Maintenance
- Cleaning and Disinfecting

Regular Maintenance

In the interest of equipment safety, a regular maintenance program must be established. This maintenance program should consist of cleaning and disinfecting as well as annual system function checking. It is the owner's responsibility to arrange for this service and to assure that the personnel performing this are fully qualified to service Progeny Dental X-ray equipment.

Cleaning and Disinfecting

The Progeny Vantage Panoramic X-ray System requires disinfection. The cleaning and disinfecting methods described here protect operators and patients in a manner that is safe for the equipment.

Cleaning Compounds

Progeny Dental recommends the use of a broad spectrum surface disinfectant/cleaning product, such as Cavicide™, or chemical equivalent.

Cleaning Methods

Between each patient, perform the following cleaning and disinfecting steps.

1. Remove gross bio-burden from the chin rest, bite guide, handles and structure with a disposable towel moistened with water.
2. Dry the chin rest, bite guide, handles and structure with disposable towels.
3. Wipe the chin rest, bite guide, handles and structure with the disinfectant/cleaning product following the manufacturer's instructions.
4. Clean any remaining disinfectant/cleaning product from the component with water. This additional step prevents possible product discoloration or corrosion.
5. Dry the patient contact areas with disposable towels.

CAUTION! The Progeny Vantage Panoramic X-ray System is not waterproof. Use only moistened, not saturated, towels.

14 Error Messages

In this Chapter

- Message Overview
- Messages and Actions
- Message Center Interactive Screen

Message Overview

The Vantage Panoramic system displays informational messages and system messages. When the system encounters a problem, the message window appears on the Touch Control Panel. The message window includes a description of the problem, the OK button, and the Message Center icon.

Informational Message

This message is distinguished from the System Message by its blue header, and the wording, "MESSAGE". The Informational Message indicates that the Vantage system can still be used, although all functions may not be available.

Example of an Informational Message

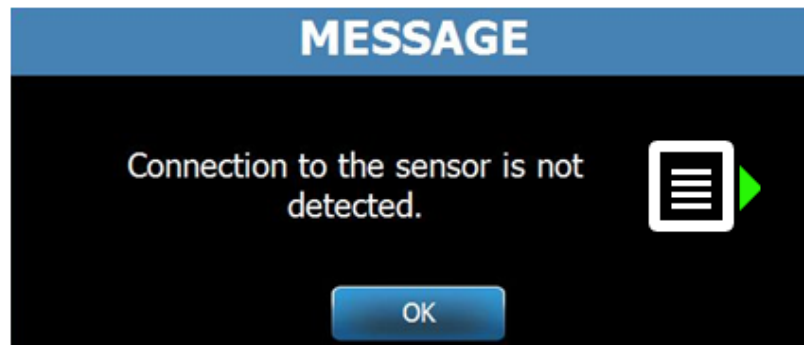

System Message

This message is distinguished from the Informational Message by its green header, and the wording, “SYSTEM”. The System Message identifies a system-wide error. The Vantage system cannot be used until the problem is resolved.

Example of a System Message



Exiting a Message Window

When a message window pops up, you have two options:

- Tapping the Message Center icon  takes you to the Message Center window. *For more information, see Working with the Message Center in this chapter.*
- Clicking **OK** closes the message window.

Messages and Actions

Before following the actions of a specific message, some general steps are very helpful:

- Verify the Vantage device is powered up, and the Progeny client software is running on a computer system running on the same network as the Vantage..
- If appropriate, use the Recall Last Image to retransmit the last image. *For more information, see Recalling the Last Image in chapter 11.*
- Cycle the power on the device off and on once.

The following table identifies the text of each message and specific actions you can take for that message.

| Message Text | Action |
|---|--|
| Connection to the device is not detected. | 1. Call Technical Service. |
| Connection to the sensor is not detected. | 1. Click OK. 2. Wait for Vantage System to recover. 3. Detach and re-attach the sensor. 4. Wait for the sensor to get ready, approximately one minute. 5. If message persists, call Technical Service. 6. If desired, run the Vantage System in Demo mode with no radiation emitted. <i>For more information, see Using the Demo Mode in chapter 8.</i> |
| Control Panel has encountered a protocol error. | 1. Call Technical Service. |
| Device Controller has encountered an error. | 1. Press OK on Message screen. 2. Wait for Vantage System to recover. 3. If message re-appears, restart the Vantage system. 4. If message persists, call Technical Service. |
| Image transmission is incorrect. | 1. Click OK. 2. Wait for Vantage System to recover, and to determine if Image Preview appears. 3. If it does, verify the accuracy of the image. 4. If there is no image or the displayed one is inaccurate, retake the image. |
| Procedure was interrupted before completion. | Message appears when the exposure button is released before the device stops moving. 1. Click OK. 2. Wait for Vantage System to recover, and to determine if Image Preview appears. 3. If it does, verify the accuracy of the image. 4. If there is no image or the displayed one is inaccurate, retake the image. |

| Message Text | Action |
|---|--|
| Sensor has encountered a calibration error. | <ol style="list-style-type: none"> 1. Call Technical Service. 2. If desired, run the Vantage System in Demo mode with no radiation emitted. <i>For more information, see Using the Demo Mode in chapter 8.</i> |
| Sensor has encountered a malfunction. Please replace the sensor. | <ol style="list-style-type: none"> 1. Click OK. 2. Wait for Vantage System to recover. 3. Detach and re-attach the sensor. 4. Wait for the sensor to get ready, approximately one minute. 5. If message persists, call Technical Service. 6. If desired, run the Vantage System in Demo mode with no radiation emitted. <i>For more information, see Using the Demo Mode in chapter 8.</i> |
| Sensor has encountered an error. | <ol style="list-style-type: none"> 1. Click OK. 2. Wait for Vantage System to recover. 3. Detach and re-attach the sensor. 4. Wait for the sensor to get ready, approximately one minute. 5. If message persists, call Technical Service. 6. If desired, run the Vantage System in Demo mode with no radiation emitted. <i>For more information, see Using the Demo Mode in chapter 8</i> |
| System cannot execute selected function. Please try again. | <ol style="list-style-type: none"> 1. Click OK. 2. Wait for Vantage System to recover. 3. Repeat the action taken. 4. If the message recurs, restart the Vantage System. 5. If the message persists, call Technical Service. |
| System has encountered an error. Current procedure was interrupted due to time-out. | <ol style="list-style-type: none"> 1. Click OK. 2. Wait for Vantage System to recover from the condition. |

Message Center Interactive Screen

The Message Center screen is an interactive Touch Control Panel screen that displays messages for various components of the Vantage Panoramic system. Touching a component on the screen highlights the messages for that component.

Interactive Message Center Screen

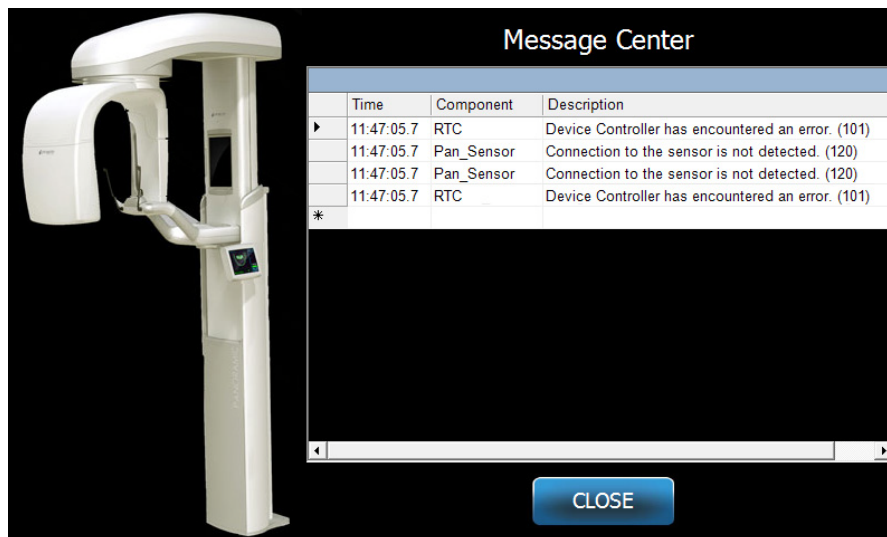

To access the Message Center:

- On the Acquisition Setup screen, tap the Options button, then tap the Message Center button.
- On a Safe or Offline screen, tap the Message Center icon.

Message Center Icon



15 Technical Data Sheet

Vantage System Function Checklist

Perform the tasks on this checklist to verify electrical, mechanical, and software readiness of the Vantage Panoramic X-ray System.

System Readiness Checklist

| <input checked="" type="checkbox"/> | Task Area | Description |
|-------------------------------------|--------------------------------------|---|
| | Floor and Wall | Ensure that the wall support is adequate and that the system is securely attached to the wall and floor. For freestanding units, the structure must be firmly attached to the floor. |
| | Mechanical Safety | Inspect the structure for mechanical integrity of the telescoping column. Inspect the condition of the main drive lead screw, bearings, overhead attachment and pivot points, C-arm attachment and pivot points, and the patient table attachment. |
| | Electrical Safety | Verify integrity of the power line and its connections, and the connection to earth ground. |
| | Labels | Ensure that all certified components bear labels that include the model and serial number, date of manufacture, and a statement of certification. |
| | Diagnostic Source Assembly | Under the tubehead cover, evaluate the condition of the following items: collimator attachment, collimator blade mechanism, electrical connections, and mechanical attachment of the tubehead and collimator to the structure. Check for oil leaks. |
| | Power Switch | Verify that the switch is working and that the operator panel illuminates when the power switch is in the ON position. |
| | Operator Panel / Touch Control Panel | A few seconds after power up, the splash screen should appear. The screen should display the status when the Vantage Client software is started. The panel must switch to the main screen when the VantageTouch software and all related devices are up and running. The panel functions must respond to interrogation. |
| | Movement Control Switches | Verify wand positioning and column vertical drive. |
| | Laser Operation and alignment | The mid-Sagittal, Frankfort plane, and Cuspid lasers operate on demand by way of the activation switches on the patient table. Verify alignment through the use of the laser test fixtures. |

| | |
|---------------------------------|---|
| Exposure Switch | Verify that the exposure switch is functioning properly. To make an exposure, follow the procedures outlined in this manual. |
| Exposure Indicators | Make several exposures. Verify that the visual radiation indicator illuminates and that the audible radiation indicator generates a tone. |
| Premature Exposure Termination. | During an exposure, release the exposure switch before the normal end of the panoramic sweep. All movement must cease, the x-ray output must stop, and the visual and audible indicators must end. |
| Error Messages | During normal operation, the appearance of any error message must be investigated and corrected. Error messages may occur due to operator error or machine malfunction. Contact Progeny Technical Support with any questions. |
| X-ray Generator Inspections | Perform complete panoramic trial exposures. Absence of error messages demonstrates proper generator operation. |
| Beam alignment Verification | Verify alignment between x-ray source and image receptor. |
| Sensor Operation | Perform a trial examination on the test phantom. Evaluate the outcome of this trial exam. Sufficient contrast, sharpness and penetration must be evident in the image. |
| Focal Trough Verification | Perform a trial examination on the test phantom. Evaluate the outcome of this trial exam. The focal trough must be located in the predicted position. |
| User Information | The User manual should remain in the possession of the primary system operator. Replacement copies are available through Progeny Technical Support. |
| Imaging Software | Make sure the imaging software is running and available. |

System Specifications Sheet

| | | |
|--|----------------------------|--|
| X-ray Generator | Constant Potential | Microprocessor controlled voltage and current. |
| X-ray Tube | Toshiba | D-054SB 1750W max. DC. |
| Focal spot size | 0.5 mm ² | Conforms to IEC 60336/2005 |
| Total Filtration | Min. 3.2 mm Al | |
| Anode Voltage | Panoramic | 54-84 kVp +/- 10% |
| Anode Current | Panoramic | 4-14mA +/- 20% 14 mA max. 1140 watts max. |
| Scan Time | Panoramic Cephalometric | 2.5 – 16 seconds as indicated +/- 10% 9-15.6 seconds +/- 10% |
| SID | Panoramic Cephalometric | 500 mm (20") Left 1,680 mm (66.1"), Right 1,707 mm (67.2") |
| Magnification | Panoramic Cephalometric | Constant 1.2 horizontal and vertical +/- 0.05 Constant 1.1 horizontal and vertical +/- 0.05 |
| Image pixel size | 96 by 96 μm | 2 by 2 binning for 96 μm by 96 μm output pixel size. |
| CCD active area | Panoramic Cephalometric | 6.144 mm x 146 mm (0.25" x 5.8") 6.144mm x 221 mm (0.25" x 8.7") |
| Image field | Panoramic Cephalometric | 14 x 30 cm (5.8 x 12") 21 x 30 cm (8.2 x 12") |
| Pixels/exposure | Panoramic Cephalometric | 3072 x 6250 16 bits per pixel 4608 x 6250 16 bits per pixel |
| CCD data rate | | 4 Mwords/Sec. 8 Mbytes/Sec. |
| MaxImage data size | Panoramic Cephalometric | 19.2 MBytes 28.8 MBytes |
| Attenuation Equivalent of Image Receptor | | 0.4 mm Al |
| Maximum Heat Dissipation into Surrounding Air | | 0.3 BTU |
| Line Voltage | | 110-240 VAC +/- 10% 50/60 Hz |
| Duty Cycle | | 1:30 |
| Operating Temperature | | +10° C/+35° C (+50° F/+95° F) |
| Storage Temperature | | -35° C/+66° C (-31° F/+150° F) |
| Maximum Altitude | | 3650 m (12,000 ft.) |

Appendix

X-Ray Tube Information

Tube can be either Toshiba D-054SB or Kailong KL29SB (rating charts are the same).

Maximum Rating Charts (Absolute maximum rating charts)

Constant potential high-voltage generator

Nominal Focal Spot Value: 0.5

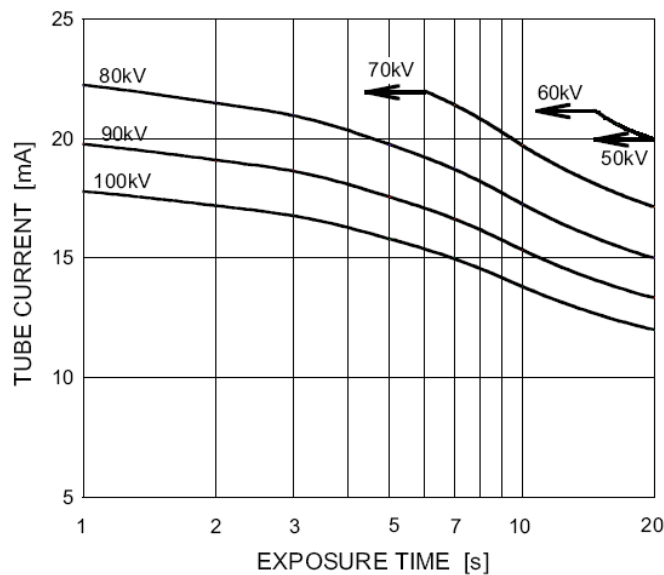

Anode Thermal Characteristics

