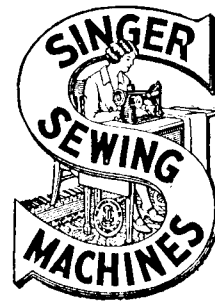


Form 18695
October, 1933
PRINTED IN U. S. A.

LIST OF PARTS



MACHINES

Nos. 147-50 and 147-51

THE SINGER MANUFACTURING COMPANY

INSTRUCTIONS FOR OILING

These machines are equipped with an oiling system which automatically delivers the proper amount of oil to the principal bearings of the machine.

Oil in a reservoir in the arm is picked up by a scoop on the connecting rod, and lubricates the various bearings inside the arm by splash. A cup within the arm catches some of this oil, and connecting pipes and wicks distribute it to the principal bearings outside the arm.

In order that this system may operate, it is absolutely necessary that the instructions be observed to the letter.

Caution: Use only a good grade of medium oil (Singer Cloth and Leather Oil). Do not use a light oil such as Stainless Oil.

A machine new from the factory, or one that has not been operated for some time, must be serviced as specified in Form 18558. (Instructions for Using and Adjusting Singer Sewing Machines Nos. 147-50 and 147-51).

Genuine Singer Needles should be used
in Singer Machines.
These Needles and their Containers
are marked with the
Company's Trade Mark "SIMANCO." 1

Needles in Containers marked
"For Singer Machines"
are not Singer made needles. 2

INDEX

	PAGE
ACCESSORIES	30
BELT GUARD	30
BENCH STAND	30
FOOT LIFTER PARTS	31
KNEE LIFTER PARTS	31
MACHINE BASE	32
" " OIL DRAIN JAR	32
" No. 147-50	7
" " 147-51	19
NUMERICAL LIST OF PARTS	35
OBSOLETE PARTS	34
THREAD UNWINDER	33

INSTRUCTIONS FOR ORDERING

In ordering from this list, use **ONLY** the part NUMBER in the **FIRST** column.

The number stamped on a Sewing Machine Part is in every case the number of the single part only.

Every combination of parts sent out as such has its specific number, which, although not stamped on the parts, must be used when ordering the combination.

Each number always indicates the **SAME PART** in whatever list it appears, or for whatever machine.

The letters after some of the numbers indicate the style of finish only, as follows:

- A—Hardened, Polished, Nickel Plated and Buffed
- B—Polished, Nickel Plated and Buffed
- C—Hardened Only
- D—Polished Only
- E—Soft, Not Polished
- F—Hardened and Polished
- H—Blued
- J—Nickel Plated Only
- K—Hardened and Nickel Plated
- L—Brass Plated
- M—Oxidized
- N—Japanned, Dull
- P—Japanned, Bright
- R—Merlized
- T—Copper Plated
- T. A.—Hardened, Polished, Copper and Nickel Plated and Buffed
- T. B.—Copper and Nickel Plated and Polished
- T. J.—Copper and Nickel Plated Only
- T. K.—Hardened, Copper and Nickel Plated
- T. M.—Copper Plated and Oxidized
- T. L.—Copper and Brass Plated
- U—Zinc Plated
- V—Silver Plated
- W—Polished and Nickel Plated
- Y—Black Nickel Plated Only
- Z—Chromium Plated
- Z. B.—Polished, Nickel Plated, Buffed and Chromium Plated
- Z. J.—Nickel and Chromium Plated

These letters **MUST BE USED** when they appear in the list; and **AFTER** the number **as** in the list.

In this series:

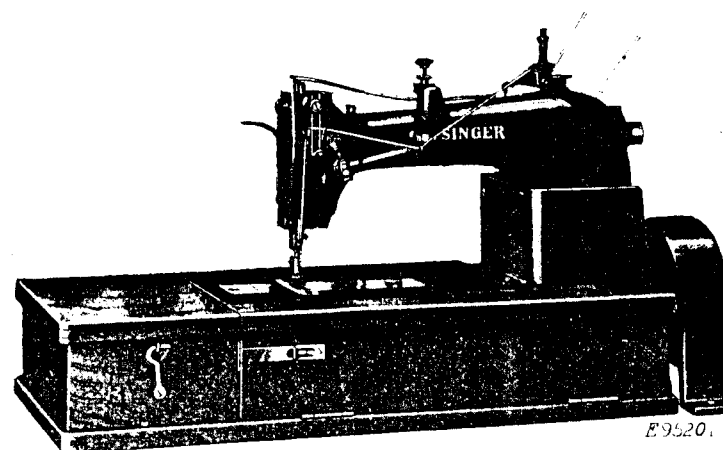
- 1 to 1500 and 50001 to 51500 are Screw Numbers
- 1501 to 1800 and 51501 to 51800 are Nut Numbers
- 1801 to 2000 and 51801 to 52000 are Roller Numbers
- 2001 to 50000 and 52001 and upward are numbers of Machine Parts

The figures in the second column refer only to the plates, illustrating the parts, and are **NOT TO BE USED** in ordering.

Parts marked with an asterisk (*) are furnished only when repairs are made at factory.

LIST OF PARTS COMPLETE

FOR



MACHINE No. 147-50

FOR GENERAL WORK IN LIGHT WEIGHT FABRICS. ONE NEEDLE, ONE LOOPER. SHORT NEEDLE BAR AND LOOPER STROKE. THE LOOPER IS ARRANGED SO THAT IT MAY BE THROWN OUT OF POSITION FOR CONVENIENCE IN THREADING. AN IMPROVED OILING SYSTEM AUTOMATICALLY OILS ALL OF THE PRINCIPAL BEARINGS OF THE MACHINE. BALANCE WHEEL NO. 64259. DIAMETER OF BELT GROOVE 2 INCHES. SPEED UP TO 4300.

NO.	PLATE	NAME
*68427	—	Arm, upper and lower (solid) with 948b, 15404, 68483, two 15405 and four 131022.
68428	9917	Arm Bottom Cover.
68429	9917	“ “ “ Gasket (cork).
1057e	20503	“ “ “ Screw.
68350	9922	“ Oil Cup, for oiling Arm Rock Shaft Front Bearing.
68430	9922	Arm Oil Cup, for filling oil reservoir. . .
54648	9922	“ “ “ Oil Pad (braided cotton)
131293	—	“ Rock Shaft.
131294	—	“ “ “ 131293 with 1235F and 131295.

NO.	PLATE	NAME
1309c	20504	Arm Rock Shaft Adjusting Screw.....
131056	20504	" " " " " Washer
68433	9916	" " " " Bushing (back).....
68434	---	" " " " " " 68433 with 52045.....
68435	9916	Arm Rock Shaft Bushing (back) Cap
131095	9916	" " " " " " "
		Washer (fibre).....
52045	9922	Arm Rock Shaft Bushing (back) Oil Pad (wick).....
446c	20503	Arm Rock Shaft Bushing (back) Set Screw.....
68436	9916	Arm Rock Shaft Bushing (intermediate)
68437	---	" " " " " "
		68436 with 52045.....
52045	9922	Arm Rock Shaft Bushing (intermediate) Oil Pad (wick).....
423c	20503	Arm Rock Shaft Bushing (intermediate) Set Screw.....
131072	9916	Arm Rock Shaft Crank, back (ball bearing, solid) with two 50083c.....
50083c	20503	Arm Rock Shaft Crank (back) Set Screw.....
131295	---	Arm Rock Shaft Crank (front) with 853c
127838	---	" " " " " Pin.....
54105	9916	" " " " Flanged Bushing (front)
52045	9922	" " " " " " "
		Oil Pad (wick).....
453c	20503	Arm Rock Shaft Flanged Bushing (front) Set Screw.....
1235F	20503	Arm Rock Shaft Oil Plug Screw.....
42365	9922	" " " " Pad (braided cot- ton) for oiling Back Bearing.....
54969	9922	Arm Rock Shaft Oil Pad (braided cot- ton) for oiling Intermediate Bearing
*68440	20508	Arm Rotary Shaft.....

NOTE: When No. 68440 is required for repairs,
the Loper Driving Shaft and Feed Lifting
Eccentric must be returned to the factory
to be adjusted to the new part.

68441	---	Arm Rotary Shaft 68440 with 640E, 54450, 68459, 68470, 68482 and 131016.....
68442	20520	Arm Rotary Shaft Bushing (front).....
761E	20503	" " " " " Set Screw.....

NO.	PLATE	NAME
68443	9917	Arm Rotary Shaft Bushing (inter- mediate).....
68444	---	Arm Rotary Shaft Bushing (inter- mediate) 68443 with 41128.....
41128	9922	Arm Rotary Shaft Bushing (inter- mediate) Oil Pad (braided cotton)...
422c	20503	Arm Rotary Shaft Bushing (inter- mediate) Set Screw (long).....
50084c	20503	Arm Rotary Shaft Bushing (inter- mediate) Set Screw (short).....
54450	20520	Arm Rotary Shaft Collar with two 1258c.....
1258c	20524	Arm Rotary Shaft Collar Set Screw....
68445	9917	" " " " Flanged Bushing....
68446	---	" " " " " " 68445 with 42367.....
42367	9922	Arm Rotary Shaft Flanged Bushing Oil Pad (braided cotton).....
159E	20503	Arm Rotary Shaft Flanged Bushing Screw.....
42367	9922	Arm Rotary Shaft Front Bearing Oil Pad, lower (braided cotton).....
54218	9922	Arm Rotary Shaft Front Bearing Oil Pad, upper (braided cotton).....
57974	9922	Arm Rotary Shaft Oil Pad (braided cotton) for oiling Back Bearing.....
56006	9922	Arm Rotary Shaft Oil Pad (braided cotton) for oiling Intermediate Bear- ing.....
144D	20503	Arm Rotary Shaft Screw.....
131276	20526	" Side Cover (oil vent).....
131278	---	Arm Side Cover (oil vent) complete, Nos. 286J, 131276, 131277 and 131280
131277	20526	Arm Side Cover Cap.....
131280	20520	" " " " Steady Pin.....
286J	20503	" " " " Thumb Screw....
68448	9917	" " " " Gasket (cork).....
1057J	20503	" " " " Screw.....
64259	20508	Balance Wheel, 2 in. pulley, with two 51283c.....
51283c	20503	Balance Wheel Set Screw.....
68449	20508	Cloth Plate for 131081.....
131259	---	" " for 131262.....
68368	9918	" " Slide (left).....
131050	9918	" " " " Spring.....
725J	20503	" " " " " Screw....

NO.	PLATE	NAME
131051	----	Cloth Plate Slide (left) complete, Nos. 68368, 131050 and two 725j.....
54014	20527	Cloth Plate Slide (right) for 54015.....
131260	20527	" " " " " 131261.....
38419	20504	" " " " " Spring.....
725j	20503	" " " " " Screw..
54015	----	Cloth Plate Slide (right) complete for 131081, Nos. 38419, 54014 and two 725j.....
131261	----	Cloth Plate Slide (right) complete for 131262, Nos. 38419, 131260 and two 725j.....
131081	----	Cloth Plate complete for 38486, Nos. 54015, 68419 and 131051.....
131262	----	Cloth Plate complete, for binding, for 131255, Nos. 131051, 131259 and 131261.....
1011F	20503	Cloth Plate Screw (left).....
50396F	20503	" " " (right).....
131130	20508	" " Thread Guard.....
1235F	20503	" " " " " Screw (lower)
1095F	20521	" " " " " (upper)
68452	9916	Crank Connecting Rod (rod only).....
*68453	----	" " " " Cap (lower)....
896E	20503	" " " " " Screw
*54018	----	" " " " " (upper)....
1057E	20503	" " " " " Screw
*68454	----	" " " " End Bearing (lower).....
*68455	----	Crank Connecting Rod End Bearing (upper).....
68456	9916	Crank Connecting Rod Head (lower), Nos. 68453, 68454 and two 896E.....
68457	9916	Crank Connecting Rod Head (upper), Nos. 54018, 68455 and two 1057E....
1722E	20503	Crank Connecting Rod Nut (lower)....
1723E	20503	" " " " (upper)....
68458	9916	Crank Connecting Rod complete, Nos. 1722E, 1723E, 68452, 68456 and 68457
68459	----	Crank Connecting Rod 68458 with 131072.....
68460	9918	Face Plate (lower half).....
68461	9918	" " " " (Gasket (cork) ..
330D	20503	" " " " " Screw.....
68462	9918	" " (upper half).....
29234	20504	" " " " " Position Plate
1053E	20501	" " " " " " " Screw.....

NO.	PLATE	NAME
286D	20503	Face Plate (upper half) Thumb Screw.
68463	9918	Feed Bar.....
68464	9918	Feed Bar complete, Nos. 50429c, 54648, 68463, 68467 and two 207E.....
131197	9918	Feed Bar Hinge Pin (eccentric).....
59343	20520	" " " " Collar with 735c..
735C	20523	" " " " " Set Screw..
54648	9922	" " Oil Pad (braided cotton).....
134258	9918	" " Slide Block.....
134259	9918	" " " " 134258 with 68495 and 134260.....
68495	9922	Feed Bar Slide Block Oil Pad (wick)...
134260	9922	" " " " " Retainer
68467	9918	" " Wearing Plate.....
207E	20503	" " " " " Screw.....
68468	9918	" Connecting Rod with 1057E, 68469, 131090, 134260 and two 896E.....
*68469	----	Feed Connecting Rod Cap.....
68470	----	" " " 68468 with 68474
896E	20503	" " " Cap Screw.....
1057E	20503	" " " Clamping Screw..
68471	9918	" " " Cover.....
176j	20503	" " " " Screw.....
131090	9922	" " " Oil Pad (wick)....
134260	9922	" " " " " Retainer
54177	20525	" Dog, 16 teeth (16 teeth to the inch) for 38486.....
54249	20525	Feed Dog, 20 teeth (16 teeth to the inch) for binding, for 131255.....
157j	20503	Feed Dog Screw.....
50429c	20503	" " Stop Screw.....
*68473	----	" Eccentric.....
*54455	----	" " Body.....
51061c	20503	" " " Set Screw.....
7071	20520	" " Clamping Washer.....
217j	20503	" " " " " Screw
68474	9918	Feed Eccentric (adjustable) complete, Nos. 217j, 1103c, 7071, 54455, 68473 and two 51061c.....
1103c	20503	Feed Regulating Screw.....
131240	20502	" Rocking Frame with two 453c....
131196	----	" " " 131240 with 59343, 68464 and 131197.....
57234	20502	Feed Rocking Frame Hinge Pin.....
57235	20520	" " " " " Bushing
453c	20503	" " " " " " " Set Screw.....

NO.	PLATE	NAME
453C	20503	Feed Rocking Frame Hinge Pin Set Screw.....
25618	20522	Guide.....
286D	20503	" Thumb Screw.....
131079	20521	Looper (closed eye).....
54027	20521	" Carrier with two 175E.....
175E	20521	" " Adjusting Screw.....
54227	20521	" " Connection.....
54228	20521	" " " Shaft.....
68478	20521	" " " " Sleeve (eccentric).....
51263D	20521	Looper Carrier Connection Shaft Sleeve Cap Screw.....
128419	9922	Looper Carrier Connection Shaft Oil Pad (braided cotton).....
68479	20521	Looper Carrier Driver with 68480 and four 175E.....
*68480	—	Looper Carrier Driver Cap.....
175E	20521	" " " " Screw.....
*68481	20502	Looper Driving Shaft and Feed Lifting Eccentric with two 64315.....

NOTE: When No. 68481 is required for repairs, the
Arm Rotary Shaft must be returned to the
factory to be adjusted to the new part.

*68482	—	Looper Driving Shaft and Feed Lifting Eccentric 68481 with 54027, 54227, 54228 and 68479.....
*68483	—	Looper Driving Shaft and Feed Lifting Eccentric Bracket with 761E.....
948D	20503	Looper Driving Shaft and Feed Lifting Eccentric Bracket Screw.....
68484	20502	Looper Driving Shaft and Feed Lifting Eccentric Bushing.....
131028	20524	Looper Driving Shaft and Feed Lifting Eccentric Bushing Oil Plug.....
761E	20503	Looper Driving Shaft and Feed Lifting Eccentric Bushing Position Screw....
68497	9922	Looper Driving Shaft and Feed Lifting Eccentric Front Bearing Oil Pad (wick).....
64315	20524	Looper Driving Shaft and Feed Lifting Eccentric Oil Hole Plug.....
640E	20503	Looper Driving Shaft and Feed Lifting Eccentric Screw.....
54035	20521	Looper Holder with 1120c.....
51119J	20503	" " Screw.....

NO.	PLATE	NAME
1120c	20521	Looper Set Screw.....
68485	20502	" Throw-out Handle with two 443c.....
68486	20502	Looper Throw-out Handle Plunger....
43503	20504	" " " " Spring
443c	20503	" " " Set Screw....
54036	20523	Needle Bar (hollow) with 857c.....
131291	—	" " Bushing (lower).....
1133E	20523	" " " " Set Screw..
64320	20523	" " " (upper).....
1133E	20523	" " " " Set Screw
68488	20523	" " Connecting Link and Thread (upper) Controller.....
68489	20523	Needle Bar Connecting Link Hinge Stud (hollow).....
68490	—	Needle Bar Connecting Link Hinge Stud 68489 with 861c and 131270.....
1520J	20523	Needle Bar Connecting Link Hinge Stud Nut.....
131270	20523	Needle Bar Connecting Link Hinge Stud Nut Oil Pad (wick).....
861c	20523	Needle Bar Connecting Link Hinge Stud Oil Plug Screw.....
853c	20523	Needle Bar Connecting Link Hinge Stud Set Screw.....
68491	20523	Needle Bar Connecting Stud with 211F and two 187E.....
187E	20523	Needle Bar Connecting Stud Clamping Screw.....
54037	20522	Needle Guard.....
54038	20522	" " Holder.....
176J	20503	" " " Screw.....
217c	20503	" " " Screw.....
857c	20523	" " Set Screw.....
68492	9921	Oil Pipe (back of arm) with 49191 and 68497, for oiling Feed Rocking Frame Hinge Pin Front Bearing.....
68493	9921	Oil Pipe (back of arm) Clamp.....
176E	20503	" " " " " " Screw.
68494	9921	" " " " " " Connection with 49189, 68495 and two 198E, for oiling Feed Rocking Frame Hinge Pin Back Bearing.....
*19189	—	Oil Pipe (back of arm) Connection Cap
198E	20524	" " " " " " " " Screw.....

NO.	PLATE	NAME
68495	9922	Oil Pipe (back of arm) Connection Oil Pad (wick).....
68496	9921	Oil Pipe (back of arm) Coupling.....
1733	20524	" " " " " Nut (brass).....
68497	9922	Oil Pipe (back of arm) Oil Pad (wick)...
*49191	---	" " " " " Sleeve.....
68498	9921	" " (front of arm) with 131089 and two each 1733 and 49191, for oiling Looper Driving Shaft and Feed Lifting Eccentric Front Bearing (copper tubing).....
131112	9921	Oil Pipe (front of arm) with 68497 and 131003, for oiling Feed Bar Slide Block.....
68500	9921	Oil Pipe (front of arm) with 1733, 49191, 131084 and 131089, for oiling Arm Rotary Shaft Front Bearing (copper tubing).....
131001	9921	Oil Pipe (front of arm) with 68497 and 131003, for oiling Feed Connecting Rod.....
131257	---	Oil Pipe (front of arm) complete, Nos. 68498, 68500, 131001 and 131112....
131002	9921	Oil Pipe (front of arm) Connection with 131049 and two 198E, for oiling Looper Throw-out Device.....
131003	9921	Oil Pipe (front of arm) Connection with 49189 and two 198E, for 131001 and 131112.....
131084	9921	Oil Pipe (front of arm) Connection with 131085 and two 198E, for 68500.....
*49189	---	Oil Pipe (front of arm) Connection Cap for 131003.....
*131049	---	Oil Pipe (front of arm) Connection Cap for 131002.....
*131085	---	Oil Pipe (front of arm) Connection Cap for 131084.....
198E	20524	Oil Pipe (front of arm) Connection Cap Screw.....
131004	9921	Oil Pipe (front of arm) Coupling (center).....
131004	9921	Oil Pipe (front of arm) Coupling (left).....
*131086	---	Oil Pipe (front of arm) Coupling (right).....

NO.	PLATE	NAME
131087	9921	Oil Pipe (front of arm) Coupling (right) 131086 with 131088.....
*131088	---	Oil Pipe (front of arm) Coupling (right) Oil Lead.....
1733	20524	Oil Pipe (front of arm) Coupling Nut (brass).....
68497	9922	Oil Pipe (front of arm) Oil Pad (wick) for 131001 and 131112.....
131089	9922	Oil Pipe (front of arm) Oil Pad (wick) for 68498 and 68500.....
*49191	---	Oil Pipe (front of arm) Sleeve.....
64330	20502	Presser Bar with 25303.....
25303	20523	" " Ball, size 1/4 in.....
131006	20523	" " Bushing (lower).....
1133E	20523	" " " " Set Screw.
38456	20523	" " " (upper).....
1133E	20523	" " " " Set Screw.
54039	20522	" " Guide Bracket with 453c, 640j and 1963.....
640j	20503	Presser Bar Guide Bracket Adjusting Screw.....
11173	20522	Presser Bar Guide Bracket Guide.....
447c	20522	" " " " " Set Screw.....
1963	20522	Presser Bar Guide Bracket Roller and Stud.....
453c	20503	Presser Bar Guide Bracket Set Screw...
57257	20504	" " Lifter.....
50592c	20504	" " " Hinge Screw.....
1250c	20504	" " " Stop Screw.....
131007	20522	" " Lifting Bracket with 462c..
131008	20522	" " " " Connection
61075	20522	" " " " " Connecting Pin.....
462c	20522	Presser Bar Lifting Bracket Connection Connecting Pin Set Screw.....
131009	20502	Presser Bar Lifting Lever.....
68184	20502	" " " " Extension (back).....
161j	20504	Presser Bar Lifting Lever Extension (back) Screw.....
131010	20502	Presser Bar Lifting Lever Extension (front).....
176j	20503	Presser Bar Lifting Lever Extension (front) Screw.....
802D	20504	Presser Bar Lifting Lever Hinge Screw.
38467	20502	" " Spring (flat).....

NO.	PLATE	NAME
38468	20524	Presser Bar Spring Stud.....
26276	20525	" Foot Hinge Pin.....
46056	-----	" " Plate.....
46057	-----	" " Shank.....
46058	20525	Presser Foot (hinged) complete, Nos. 26276, 46056 and 46057.....
190j	20524	Presser Foot Screw.....
574w	20524	Pressure Regulating Thumb Screw.....
1539w	20524	" " " " Lock Nut.....
131025	20524	Slack Thread Controller.....
51242	20524	" " " Clamp.....
190j	20524	" " " " Screw..
54041	20524	" " Regulator.....
54042	20524	" " " Holder with 175E and two 50150c.....
175E	20521	Slack Thread Regulator Holder Champ- ing Screw.....
131012	20524	Slack Thread Regulator Holder Shaft
24292	20524	" " " " "
1019c	20524	Collar with 1019c.....
1019c	20524	Slack Thread Regulator Holder Shaft Collar Set Screw.....
54044	20521	Slack Thread Regulator Holder Shaft Crank (forked) with 1253c.....
1253c	20522	Slack Thread Regulator Holder Shaft Crank Set Screw.....
50150c	20524	Slack Thread Regulator Set Screw.....
131012	20502	Tension (under thread) Bracket.....
691F	9924	" " " " Screw..
2102	9924	" " " Disc.....
51570c	9924	" " " Regulating Thumb Nut.....
50326c	9924	Tension (under thread) Screw Stud
59539	-----	" " " " " 50326c with 51570c.....
59534	9924	Tension (under thread) Spring.....
59537	9924	" " " " Bushing (large).....
59538	9924	Tension (under thread) Spring Bushing (small).....
57076	9924	Tension (under thread) Thread Guide (double).....
54045	20527	Tension (upper thread) Bracket.....
376j	9924	" " " " Screw..
2102	9924	" " " Disc.....
51570c	9924	" " " Regulating Thumb Nut.....

NO.	PLATE	NAME
32572	9924	Tension (upper thread) Releasing Disc.
54988	9924	" " " " Pin..
54046	20527	" " " " Shaft
54047	9924	" " " " " Crank with 624c.....
54048	9924	Tension (upper thread) Releasing Shaft Crank Link.....
624c	9924	Tension (upper thread) Releasing Shaft Crank Set Screw.....
68261	9924	Tension (upper thread) Releasing Shaft Spring.....
131011	9924	Tension (upper thread) Releasing Shaft Spring Position Plate.....
316c	9924	Tension (upper thread) Releasing Shaft Stop Screw.....
1547J	9924	Tension (upper thread) Releasing Shaft Stop Screw Nut.....
50326c	9924	Tension (upper thread) S c r e w S t u d
59539	-----	" " " " " 50326c with 51570c.....
59535	9924	Tension (upper thread) Spring.....
59537	9924	" " " " Bushing (large).....
59538	9924	Tension (upper thread) Spring Bushing (small).....
57076	9924	Tension (upper thread) Thread Guide (double).....
53225	9924	Thread (under) Eyelet (back).....
190j	20524	" " " " Screw..
131080	20524	" " " (front).....
131014	20524	" " Take-up with two 51334c
51334c	20524	" " " Set Screw.....
38478	20524	" " " Staple with two each 590b and 38481.....
131157	20527	Thread (under) Take-up Staple Bracket with 460c.....
965D	20504	Thread (under) Take-up Staple Bracket Screw.....
46041	20520	Thread (under) Take-up Staple Spring
190j	20524	" " " " " Screw.....
38481	20524	Thread (under) Take-up Staple Thread Guard.....
590D	20524	Thread (under) Take-up Staple Thread Guard Screw.....

NO.	PLATE	NAME
131096	20520	Thread (under) Take-up Stripper.....
190j	20524	“ “ “ “ Screw
131016	20520	“ “ “ Thread Guard (brass).....
64356	20520	Thread (under) Take-up Thread Guard Steady Pin.....
460c	20520	Thread (under) Take-up Thread Guard Steady Pin Set Screw.....
38484	20520	Thread (upper) Eyelet.....
190j	20524	“ “ “ “ Screw.....
54193	20520	“ “ “ Take-up.....
54194	20520	“ “ “ Plate.....
68164	20520	“ “ “ “ Spring....
1449j	20520	“ “ “ “ “ Screw
54195	—	Thread (upper) Take-up complete, Nos. 1449j, 54193, 54194 and 68164.....
211f	20523	Thread (upper) Take-up Set Screw.....
38486	20525	Throat Plate for 54177.....
131255	20525	“ “ “ binding, for 54249....
742f	20504	“ “ “ Screw.....
*15404	—	Trade Mark.....
15405	—	“ “ “ Rivet.....

Genuine Singer Needles should be used
in Singer Machines.
These Needles and their Containers
are marked with the
Company's Trade Mark "SIMANCO." 1

Needles in Containers marked
"For Singer Machines"
are not Singer made needles. 2

LIST OF PARTS COMPLETE FOR MACHINE No. 147-51

FOR SEAMING PANTS, KNICKERS, PLAY SUITS, LIGHT AND MEDIUM OVERALLS, UPHOLSTERY, SEAT COVERS, KNIT UNDERWEAR, BATHING SUITS, MATTRESS WORK, WORK SHIRTS, FLANNEL OR HEAVY MATERIAL, FABRIC GLOVES, ETC. ONE NEEDLE, ONE LOOPER. NEEDLE BAR STROKE 1 7/8 INCHES. THE LOOPER IS ARRANGED SO THAT IT CAN BE THROWN OUT OF POSITION FOR CONVENIENCE IN THREADING. AN IMPROVED OILING SYSTEM AUTOMATICALLY OILS ALL OF THE PRINCIPAL BEARINGS OF THE MACHINE. BALANCE WHEEL NO. 64259. DIAMETER OF BELT GROOVE 2 INCHES. SPEED UP TO 4000.

NO.	PLATE	NAME
*68427	—	Arm, upper and lower (solid) with 948D, 15404, 68483, two 15405 and four 131022.....
68428	9917	Arm Bottom Cover.....
68429	9917	“ “ “ Gasket (cork).....
1057E	20503	“ “ “ Screw.....
68350	9922	“ Oil Cup, for oiling Arm Rock Shaft Front Bearing.....
68430	9922	Arm Oil Cup, for filling oil reservoir....
54648	9922	“ “ “ Oil Pad (braided cotton)..
131293	—	“ Rock Shaft.....
131294	—	“ “ “ 131293 with 1235f and 131295.....
1309c	20504	Arm Rock Shaft Adjusting Screw.....
131056	20504	“ “ “ “ “ Washer
68433	9916	“ “ “ Bushing (back).....
68434	—	“ “ “ “ “ 68433 with 52045.....
68435	9916	Arm Rock Shaft Bushing (back) Cap
131095	9916	“ “ “ “ “ “ Washer (fibre).....
52045	9922	Arm Rock Shaft Bushing (back) Oil Pad (wick).....
446c	20503	Arm Rock Shaft Bushing (back) Set Screw.....
68436	9916	Arm Rock Shaft Bushing (intermediate)
68437	—	“ “ “ “ “ “ 68436 with 52045.....

NO.	PLATE	NAME
52045	9922	Arm Rock Shaft Bushing (intermediate) Oil Pad (wick).....
423c	20503	Arm Rock Shaft Bushing (intermediate) Set Screw.....
131072	9916	Arm Rock Shaft Crank, back (ball bearing, solid) with two 50083c.....
50083c	20503	Arm Rock Shaft Crank (back) Set Screw.....
131295	—	Arm Rock Shaft Crank (front) with 853c.....
127838	—	Arm Rock Shaft Crank (front) Pin.....
54105	9916	“ “ “ Flanged Bushing (front)
52045	9922	“ “ “ “ “ “ Oil Pad (wick).....
453c	20503	Arm Rock Shaft Flanged Bushing (front) Set Screw.....
1235F	20503	Arm Rock Shaft Oil Plug Screw..
42365	9922	“ “ “ “ Pad (braided cotton) for oiling Back Bearing.....
54969	9922	Arm Rock Shaft Oil Pad (braided cotton) for oiling Intermediate Bearing.....
*131104	20508	Arm Rotary Shaft.....
NOTE: When No. 131104 is required for repairs, the Looper Driving Shaft and Feed Lifting Eccentric must be returned to the factory to be adjusted to the new part.		
131105	—	Arm Rotary Shaft 131104 with 640c, 54450, 68459, 131108, 131111, 131184 and 131194.....
68442	20520	Arm Rotary Shaft Bushing (front).....
761E	20503	“ “ “ “ “ Set Screw.....
68443	9917	Arm Rotary Shaft Bushing (intermediate).....
68444	—	Arm Rotary Shaft Bushing (intermediate) 68443 with 41128.....
41128	9922	Arm Rotary Shaft Bushing (intermediate) Oil Pad (braided cotton)...
422c	20503	Arm Rotary Shaft Bushing (intermediate) Set Screw (long).....
50084c	20503	Arm Rotary Shaft Bushing (intermediate) Set Screw (short).....
54450	20520	Arm Rotary Shaft Collar with two 1258c.....

NO.	PLATE	NAME
1258c	20524	Arm Rotary Shaft Collar Set Screw.
68445	9917	“ “ “ Flanged Bushing
68446	—	“ “ “ “ “ “ 68445 with 42367.....
42367	9922	Arm Rotary Shaft Flanged Bushing Oil Pad (braided cotton).....
159E	20503	Arm Rotary Shaft Flanged Bushing Screw.....
42367	9922	Arm Rotary Shaft Front Bearing Oil Pad, lower (braided cotton).....
54218	9922	Arm Rotary Shaft Front Bearing Oil Pad, upper (braided cotton).....
57974	9922	Arm Rotary Shaft Oil Pad (braided cotton) for oiling Back Bearing.....
56006	9922	Arm Rotary Shaft Oil Pad (braided cotton) for oiling Intermediate Bearing
144D	20503	Arm Rotary Shaft Serw.....
131276	20526	“ Side Cover (oil vent).....
131278	—	Arm Side Cover (oil vent) complete, Nos. 286J, 131276, 131277 and 131280
131277	20526	Arm Side Cover Cap.....
131280	20520	“ “ “ “ Steady Pin.....
286J	20503	“ “ “ “ Thumb Screw....
68448	9917	“ “ “ Gasket (cork).....
1057J	20503	“ “ “ Screw.....
64259	20508	Balance Wheel, 2 in. pulley, with two 51283c.....
51283c	20503	Balance Wheel Set Screw.....
68449	20508	Cloth Plate for 131081.....
131259	—	“ “ “ 131262.....
68368	9918	“ “ Slide (left).....
131050	9918	“ “ “ “ Spring.....
725J	20503	“ “ “ “ “ Screw...
131051	—	Cloth Plate Slide (left) complete, Nos. 68368, 131050 and two 725J.....
54014	20527	Cloth Plate Slide (right) for 54015.....
131260	20527	“ “ “ “ “ 131261....
38419	20504	“ “ “ “ Spring.....
725J	20503	“ “ “ “ “ Screw..
54015	—	Cloth Plate Slide (right) complete for 131081, Nos. 38419, 54014 and two 725J.....
131261	—	Cloth Plate Slide (right) complete for 131262, Nos. 38419, 131260 and two 725J.....
131081	—	Cloth Plate complete for 38486, Nos. 54015, 68449 and 131051.....

NO.	PLATE	NAME
131262	-----	Cloth Plate complete, for binding, for 131255, Nos. 131051, 131259 and 131261.....
1011F	20503	Cloth Plate Screw (left).....
50396F	20503	" " " (right).....
131130	20508	" " Thread Guard.....
389F	20503	" " " " Screw (lower)
50473F	20503	" " " " " (upper)
68452	9916	Crank Connecting Rod (rod only).....
*68453	-----	" " " " Cap (lower)....
896E	20503	" " " " " Screw
*54018	-----	" " " " " (upper)....
1057E	20503	" " " " " Screw
*68454	-----	" " " " End Bearing (lower).....
*68455	-----	Crank Connecting Rod End Bearing (upper).....
68456	9916	Crank Connecting Rod Head (lower), Nos. 68453, 68454 and two 896E.....
68457	9916	Crank Connecting Rod Head (upper), Nos. 54018, 68455 and two 1057E....
1722E	20503	Crank Connecting Rod Nut (lower)....
1723E	20503	" " " " (upper)....
68458	9916	Crank Connecting Rod complete, Nos. 1722E, 1723E, 68452, 68456 and 68457
68459	-----	Crank Connecting Rod 68458 with 131072.....
68460	9918	Face Plate (lower half).....
68461	9918	" " " " Gasket (cork)...
330D	20503	" " " " Screw.....
68462	9918	" " (upper half).....
29234	20504	" " " " Position Plate
1053E	20501	" " " " " " " " Screw.....
286D	20503	Face Plate (upper half) Thumb Screw..
68463	9918	Feed Bar.....
68464	9918	Feed Bar complete, Nos. 50429c, 54648, 68463, 68467 and two 207E.....
131197	9918	Feed Bar Hinge Pin (eccentric).....
59343	20520	" " " " Collar with 735c....
735c	20523	" " " " " Set Screw..
54648	9922	" " Oil Pad (braided cotton).....
134258	9918	" " Slide Block.....
134259	9918	" " " " 134258 with 68495 and 134260.....
68495	9922	Feed Bar Slide Block Oil Pad (wick)...
134260	9922	" " " " " " Retainer

NO.	PLATE	NAME
68467	9918	Feed Bar Wearing Plate.....
207E	20503	" " " " " Screw.....
131106	20527	" Connecting Rod with 1057E, 131090, 131107, 134260 and two 896E.....
*131107	-----	Feed Connecting Rod Cap.....
131108	-----	" " " " 131106 with 54025.....
896E	20503	Feed Connecting Rod Cap Screw.....
1057E	20503	" " " " Clamping Screw..
68471	9918	" " " " Cover.....
50152J	20521	" " " " " Screw.....
131109	20520	" " " " " Spacing Washer.....
131090	9922	Feed Connecting Rod Oil Pad (wick)...
134260	9922	" " " " " Retainer
54177	20525	" Dog, 16 teeth (16 teeth to the inch) for 38486.....
54249	20525	Feed Dog, 20 teeth (16 teeth to the inch) for binding, for 131255.....
157J	20503	Feed Dog Screw.....
50429c	20503	" " Stop Screw.....
*54024	-----	" Eccentric.....
*23729	-----	" " Body.....
51061c	20503	" " " " Set Screw.....
7071	20520	" " Clamping Washer.....
217J	20503	" " " " " Screw
54025	20527	Feed Eccentric (adjustable) complete, Nos. 217J, 1103c, 7071, 23729, 54024 and two 51061c.....
1103c	20503	Feed Regulating Screw.....
131240	20502	" Rocking Frame with two 453c....
131196	-----	" " " " 131240 with 59343, 68464 and 131197.....
57234	20502	Feed Rocking Frame Hinge Pin.....
57235	20520	" " " " " " Bushing
453c	20503	" " " " " " " " Set Screw.....
453c	20503	Feed Rocking Frame Hinge Pin Set Screw.....
25618	20522	Guide.....
286D	20503	" Thumb Screw.....
131133	20521	Looper (closed eye).....
131134	-----	" 131133 with 229J and 131135...
54027	20521	" Carrier with two 175E.....
175E	20521	" " Adjusting Screw.....
54227	20521	" " Connection.....
51228	20521	" " " " Shaft.....

NO.	PLATE	NAME
68478	20521	Looper Carrier Connection Shaft Sleeve (eccentric).....
51263D	20521	Looper Carrier Connection Shaft Sleeve Cap Screw.....
128419	9922	Looper Carrier Connection Shaft Oil Pad (braided cotton).....
68479	20521	Looper Carrier Driver with 68480 and four 175E.....
*68480	—	Looper Carrier Driver Cap.....
175E	20521	“ “ “ “ Screw.....
131110	20527	“ Driving Shaft and Feed Lifting Eccentric with two 64315.....
NOTE: When No. 131110 is required for repairs, the Arm Rotary Shaft must be returned to the factory to be adjusted to the new part.		
131111	—	Looper Driving Shaft and Feed Lifting Eccentric 131110 with 54027, 54227, 54228 and 68479.....
*68483	—	Looper Driving Shaft and Feed Lifting Eccentric Bracket with 761E.....
948D	20503	Looper Driving Shaft and Feed Lifting Eccentric Bracket Screw.....
68484	20502	Looper Driving Shaft and Feed Lifting Eccentric Bushing.....
131028	20524	Looper Driving Shaft and Feed Lifting Eccentric Bushing Oil Plug.....
761E	20503	Looper Driving Shaft and Feed Lifting Eccentric Bushing Position Screw....
68497	9922	Looper Driving Shaft and Feed Lifting Eccentric Front Bearing Oil Pad (wick)
64315	20524	Looper Driving Shaft and Feed Lifting Eccentric Oil Hole Plug.....
640E	20503	Looper Driving Shaft and Feed Lifting Eccentric Screw.....
54035	20521	Looper Holder with 1120c.....
51119J	20503	“ “ Screw.....
131135	20521	“ Needle Guard with 46105.....
46105	20521	“ “ “ Pin.....
229J	20521	“ “ “ Screw.....
1120c	20521	“ Set Screw.....
68485	20502	“ Throw-out Handle with two 443c.....
68486	20502	Looper Throw-out Handle Plunger....
43503	20504	“ “ “ “ Spring
443c	20503	“ “ “ “ Set Screw....

NO.	PLATE	NAME
54036	20523	Needle Bar (hollow) with 857c.....
131291	—	“ “ Bushing (lower).....
1133E	20523	“ “ “ “ Set Screw.
64320	20523	“ “ “ (upper).....
1133E	20523	“ “ “ “ Set Screw.
68488	20523	“ “ Connecting Link and Thread (upper) Controller.....
68489	20523	Needle Bar Connecting Link Hinge Stud (hollow).....
68490	—	Needle Bar Connecting Link Hinge Stud 68489 with 861c and 131270....
1520J	20523	Needle Bar Connecting Link Hinge Stud Nut.....
131270	20523	Needle Bar Connecting Link Hinge Stud Nut Oil Pad (wick).....
861c	20523	Needle Bar Connecting Link Hinge Stud Oil Plug Screw.....
853c	20523	Needle Bar Connecting Link Hinge Stud Set Screw.....
68491	20523	Needle Bar Connecting Stud with 211F and two 187E.....
187E	20523	Needle Bar Connecting Stud Clamping Screw.....
54037	20522	Needle Guard.....
54038	20522	“ “ Holder.....
176J	20503	“ “ “ Screw.....
217c	20503	“ “ “ Screw.....
857c	20523	“ Set Screw.....
68492	9921	Oil Pipe (back of arm) with 49191 and 68497, for oiling Feed Rocking Frame Hinge Pin Front Bearing.....
68493	9921	Oil Pipe (back of arm) Clamp.....
176E	20503	“ “ “ “ “ Screw....
68494	9921	“ “ “ “ “ Connection with 49189, 68495 and two 198E, for oiling Feed Rocking Frame Hinge Pin Back Bearing.....
*49189	—	Oil Pipe (back of arm) Connection Cap
198E	20524	“ “ “ “ “ “ “ “ Screw.....
68495	9922	Oil Pipe (back of arm) Connection Oil Pad (wick).....
68496	9921	Oil Pipe (back of arm) Coupling.....
1733	20524	“ “ “ “ “ “ N u t (brass).....
68497	9922	Oil Pipe (back of arm) Oil Pad (wick)..
*49191	—	“ “ “ “ “ Sleeve.....

NO.	PLATE	NAME
68498	9921	Oil Pipe (front of arm) with 131089 and two each 1733 and 49191, for oiling Looper Driving Shaft and Feed Lifting Eccentric Front Bearing (copper tubing).....
131112	9921	Oil Pipe (front of arm) with 68497 and 131003, for oiling Feed Bar Slide Block.....
68500	9921	Oil Pipe (front of arm) with 1733, 49191, 131084 and 131089, for oiling Arm Rotary Shaft Front Bearing (copper tubing).....
131113	9921	Oil Pipe (front of arm) with 68497 and 131003, for oiling Feed Connecting Rod.....
131258	—	Oil Pipe (front of arm) complete, Nos. 68498, 68500, 131112 and 131113....
131002	9921	Oil Pipe (front of arm) Connection with 131049 and two 198E, for oiling Looper Throw-out Device.....
131003	9921	Oil Pipe (front of arm) Connection with 49189 and two 198E, for 131112 and 131113.....
131084	9921	Oil Pipe (front of arm) Connection with 131085 and two 198E, for 68500.....
*49189	—	Oil Pipe (front of arm) Connection Cap for 131003.....
*131049	—	Oil Pipe (front of arm) Connection Cap for 131002.....
*131085	—	Oil Pipe (front of arm) Connection Cap for 131084.....
198E	20524	Oil Pipe (front of arm) Connection Cap Screw.....
131004	9921	Oil Pipe (front of arm) Coupling (center).....
131004	9921	Oil Pipe (front of arm) Coupling (left).....
*131086	—	Oil Pipe (front of arm) Coupling (right).....
131087	9921	Oil Pipe (front of arm) Coupling (right) 131086 with 131088.....
*131088	—	Oil Pipe (front of arm) Coupling (right) Oil Lead.....
1733	20524	Oil Pipe (front of arm) Coupling Nut (brass).....
68497	9922	Oil Pipe (front of arm) Oil Pad (wick) for 131112 and 131113.....

NO.	PLATE	NAME
131089	9922	Oil Pipe (front of arm) Oil Pad (wick) for 68498 and 68500.....
*49191	—	Oil Pipe (front of arm) Sleeve.....
64330	20502	Presser Bar with 25303.....
25303	20523	" " Ball, size 1/4 in.....
131006	20523	" " Bushing (lower).....
1133E	20523	" " " " Set Screw..
38456	20523	" " " " (upper).....
1133E	20523	" " " " Set Screw..
54039	20522	" " Guide Bracket with 453c, 640J and 1963.....
640J	20503	Presser Bar Guide Bracket Adjusting Screw.....
11173	20522	Presser Bar Guide Bracket Guide....
447C	20522	" " " " " " Set Screw.....
1963	20522	Presser Bar Guide Bracket Roller and Stud.....
453C	20503	Presser Bar Guide Bracket Set Screw..
57257	20504	" " Lifter.....
50592C	20504	" " " Hinge Screw.....
1250C	20504	" " " Stop Screw.....
131007	20522	" " Lifting Bracket with 462C..
131008	20522	" " " " Connection
61075	20522	" " " " " " Connecting Pin.....
462C	20522	Presser Bar Lifting Bracket Connection Connecting Pin Set Screw.....
131009	20502	Presser Bar Lifting Lever.....
68184	20502	" " " " Extension (back).....
161J	20504	Presser Bar Lifting Lever Extension (back) Screw.....
131010	20502	Presser Bar Lifting Lever Extension (front).....
176J	20503	Presser Bar Lifting Lever Extension (front) Screw.....
802D	20504	Presser Bar Lifting Lever Hinge Screw..
38467	20502	" " Spring (flat).....
38468	20524	" " " Stud.....
26276	20525	" Foot Hinge Pin.....
46056	—	" " Plate.....
46057	—	" " Shank.....
46058	20525	Presser Foot (hinged) complete, Nos. 26276, 46056 and 46057.....
190J	20524	Presser Foot Screw.....

NO.	PLATE	NAME
574w	20524	Pressure Regulating Thumb Screw.....
1539w	20524	“ “ “ “ Lock Nut.....
131025	20524	Slack Thread Controller.....
54242	20524	“ “ “ Clamp.....
190j	20524	“ “ “ “ Screw..
54041	20524	“ “ Regulator.....
54042	20524	“ “ “ Holder with 175E and two 50150c.....
175E	20521	Slack Thread Regulator Holder Clamping Screw.....
131042	20524	Slack Thread Regulator Holder Shaft
24292	20524	“ “ “ “ “ Collar with 1019c.....
1019c	20524	Slack Thread Regulator Holder Shaft Collar Set Screw.....
54044	20521	Slack Thread Regulator Holder Shaft Crank (forked) with 1253c.....
1253c	20522	Slack Thread Regulator Holder Shaft Crank Set Screw.....
50150c	20524	Slack Thread Regulator Set Screw.....
131012	20502	Tension (under thread) Bracket.....
691F	9924	“ “ “ “ Screw..
2102	9924	“ “ “ Disc.....
51570c	9924	“ “ “ Regulating Thumb Nut.....
50326c	9924	Tension (under thread) Screw Stud
59539	---	“ “ “ “ “ 50326c with 51570c.....
59534	9924	Tension (under thread) Spring.....
59537	9924	“ “ “ “ Bushing (large).....
59538	9924	Tension (under thread) Spring Bushing (small).....
57076	9924	Tension (under thread) Thread Guide (double).....
54045	20527	Tension (upper thread) Bracket.....
376j	9924	“ “ “ “ Screw..
2102	9924	“ “ “ Disc.....
51570c	9924	“ “ “ Regulating Thumb Nut.....
32572	9924	Tension (upper thread) Releasing Disc..
54988	9924	“ “ “ “ Pin..
54046	20527	“ “ “ “ Shaft
54047	9924	“ “ “ “ Crank with 624c.....

NO.	PLATE	NAME
54048	9924	Tension (upper thread) Releasing Shaft Crank Link.....
624c	9924	Tension (upper thread) Releasing Shaft Crank Set Screw.....
68261	9924	Tension (upper thread) Releasing Shaft Spring.....
131011	9924	Tension (upper thread) Releasing Shaft Spring Position Plate.....
316c	9924	Tension (upper thread) Releasing Shaft Stop Screw.....
1547j	9924	Tension (upper thread) Releasing Shaft Stop Screw Nut.....
50326c	9924	Tension (upper thread) Screw Stud
59539	---	“ “ “ “ “ 50326c with 51570c.....
59535	9924	Tension (upper thread) Spring.....
59537	9924	“ “ “ “ Bushing (large).....
59538	9924	Tension (upper thread) Spring Bushing (small).....
57076	9924	Tension (upper thread) Thread Guide (double).....
53225	9924	Thread (under) Eyelet (back).....
190j	20524	“ “ “ “ Screw..
131080	20524	“ “ “ (front).....
131184	20520	“ “ Nipper Cam with 465c..
465c	20524	“ “ “ “ Set Screw
131014	20524	“ “ Take-up with two 51334c.....
51334c	20524	Thread (under) Take-up Set Screw....
38478	20524	“ “ “ Staple with two each 590b and 38481.....
131157	20527	Thread (under) Take-up Staple Bracket with 460c.....
965b	20504	Thread (under) Take-up Staple Bracket Screw.....
46041	20520	Thread (under) Take-up Staple Spring
190j	20524	“ “ “ “ “ Screw.....
38481	20524	Thread (under) Take-up Staple Thread Guard.....
590b	20524	Thread (under) Take-up Staple Thread Guard Screw.....
131096	20520	Thread (under) Take-up Stripper.....
190j	20524	“ “ “ “ Screw
131194	20520	“ “ “ Thread Guard (brass).....

NO.	PLATE	NAME
64356	20520	Thread (under) Take-up Thread Guard Steady Pin.....
460c	20520	Thread (under) Take-up Thread Guard Steady Pin Set Screw.....
38484	20520	Thread (upper) Eyelet.....
190j	20524	" " " Screw.....
54193	20520	" " " Take-up.....
54194	20520	" " " Plate.....
68164	20520	" " " " Spring
1449j	20520	" " " " " "
		Screw.....
54195	—	Thread (upper) Take-up complete, Nos. 1449j, 54193, 54194 and 68164.....
211f	20523	Thread (upper) Take-up Set Screw.....
38486	20525	Throat Plate for 54177.....
131255	20525	" " for binding, for 54249....
742f	20504	" " Screw.....
*15404	—	Trade Mark.....
15405	—	" " Rivet.....

ACCESSORIES

NO.	PLATE	NAME
120344	8941	Oiler (copper plated) with 120345.....
120345	8941	" Spout, 5 in. long.....
26026	8941	Screw Driver (large).....
26485	8941	" " (small).....
38487	8941	Threading Wire.....
120341	8941	Tweezers (curved).....
4822	8941	Wrench for 1547.....
8908	8941	" " 1520.....

BELT GUARD

NO.	PLATE	NAME
68222	20509	Belt Guard with two wood screws 1 in. No. 12.....

BENCH STAND

NO.	PLATE	NAME
79772	—	Bench Stand with 27998, two each 41538, 126849, three wood screws 1¼ No. 12, four each 60656, wood screws 1¼ in. No. 10, eight wood screws ⅝ in. No. 6 and sixteen wood screws ⅝ in. No. 7.....

NO.	PLATE	NAME
126849	20522	Flap Hinge with four wood screws ¾ in. No. 7.....
27998	20505	Flap Hook and Eye (brass) with wood screw ½ in. No. 5.....
126247	20505	Flush Bolt.....
126248	20505	" " Plate.....
41538	—	Flush Bolt with Plate complete, Nos. 126247, 126248 and four brass wood screws ⅝ in. No. 4.....
60656	20505	Hinge.....

FOOT LIFTER PARTS

NO.	PLATE	NAME
6439	—	Chain, 36 in. to 45 in., with 56864 and 56865.....

NOTE: When ordering No. 6439, state
length required.

4879	8941	Chain Connecting Link.....
56864	8941	" Hook (large).....
56865	20505	" " (small).....
126249	20509	Treadle.....
4882	8941	" Shaft.....
126250	8941	" Spring.....
126251	20509	" Stand.....
126252	20509	Treadle complete, Nos. 4882, 126249 to 126251 and two wood screws 1 in. No. 16.....

KNEE LIFTER PARTS

NO.	PLATE	NAME
37563	—	Chain, length 15 in., with 56864 and 56865.....
56864	8941	Chain Hook (large).....
56865	20505	" " (small).....
2763	20508	Rock Shaft.....
12242	20508	" " Hanger with two wood screws 1 in. No. 10.....
6335	20508	Rock Shaft Knee Arm.....
6336	—	Rock Shaft Knee Arm complete, Nos. 2766, 2767 and 6335.....
2766	20508	Rock Shaft Knee Arm Hub with 356c..
356c	20504	" " " " " Set Screw..
2767	20508	" " " " Plate with 356c.....
356c	20504	" " " " " Set Screw.....

NO.	PLATE	NAME
6337	20508	Rock Shaft Lifting Bracket with two 356c.....
7125	20508	Rock Shaft Lifting Bracket Hook.....
356c	20504	" " " " " Set Screw.....
356c	20504	Rock Shaft Lifting Bracket Set Screw..
2770	20508	" " Stop Dog with 356c.....
356c	20504	" " " " Set Screw.....
23767	20508	Rock Shaft complete, Nos. 2763, 2770, 6336, 6337, 7125 and two 12242.....

MACHINE BASE

NO.	PLATE	NAME
131263	20528	Machine Base.....
54477	20504	" " Screw Stud, to fasten base to table.....
131205	20504	Machine Base Screw Stud, to position Machine on base.....
51576E	20504	Machine Base Screw Stud Nut.....
9842	20504	" " " " Washer
131022	20504	" " " " Bushing (rubber).....
131279	20527	Machine Cushion (felt).....
131264	—	Machine Base complete, Nos. 131263, three each 9842, 51576E, 54477 and four each 131205 and 131279.....

MACHINE BASE OIL DRAIN JAR

(SWINGING TYPE)

NO.	PLATE	NAME
131185	20526	Jar (glass).....
131191	20526	" Cap.....
131188	20526	" Clamp.....
131217	—	" " 131188 with 131189.....
131189	20526	" " Lever.....
1247c	20522	" " " Hinge Screw.....
131265	20526	Nipple (long).....
131266	20526	" (short).....
131267	20526	" Elbow.....
131268	—	Machine Base Oil Drain Jar (swinging type) complete, Nos. 131185, 131191, 131217, 131266 and two each 1247c, 131265 and 131267.....

THREAD UNWINDER

FOR TWO SPOOLS

NO.	PLATE	NAME
225257	20787	Spool Rest (for two spools) with 201018c
150203	20509	" " Cushion (felt).....
225388	20787	" " Rod.....
200383c	20523	" " " Set Screw.....
201018c	20504	" " Set Screw.....
202490	20787	" Stand with 200383c.....
225391	20787	Thread Guide.....
201696J	20504	" " Lock Nut.....
225326	20504	" " Position Cup.....
225324	20787	" " Rod with 208E and 225322
208E	20522	" " " Screw.....
225322	20504	" " " Washer.....
*150085	—	" Separator.....
150086	20787	" " 150085 with 150059..
*150059	—	" " Bracket.....
150060	20787	" " " Arm with 164J and 9525.....
164J	20504	Thread Separator Bracket Arm Clamping Screw.....
9525	20524	Thread Separator Bracket Arm Clamping Screw Washer.....
164J	20504	Thread Separator Bracket Arm Screw
9525	20524	" " " " " Washer.....
150087	—	Thread Separator complete, Nos. 164J, 9525, 150060 and 150086.....
150088	20787	Thread Unwinder complete, Nos. 150087 201696J, 202490, 225257, 225324, 225326, 225388, two each 150203, 225391 and three wood screws 7/8 in. No. 12.....
27739	20527	Thread Cone (wood) for large cones....
225390	20527	" " Holder, for inverted cones

NOTE: Nos. 27739 and 225390 are used with, but not included in 150088

OBSOLETE PARTS

NO.	PLATE	NAME
68431	9916	Arm Rock Shaft, superseded by 131293, not interchangeable.....
68432	— —	Arm Rock Shaft 68431 with 1235F and 68439, use 131294.....
68439	9916	Arm Rock Shaft Crank (front) with 443c and 853c, superseded by 131295, not interchangeable.....
443c	20503	Arm Rock Shaft Crank (front) Set Screw
2117	20504	“ “ “ “ “ Pin.....
68447	9917	“ Side Cover, use 131278.....
131195	— —	Feed Rocking Frame with two 453c for 131196, use 131240.....
124500	20505	Hinge, for 79757, superseded by 126849, not interchangeable.....
131018	20509	Machine Base, use 131263.....
131019	20505	“ “ Oil Pipe.....
131020	20505	“ “ “ “ Valve.....
57285	— —	“ Cushion (felt).....
68487	29523	Needle Bar Bushing (lower), use 131291

**Genuine Singer Needles should be used
in Singer Machines.
These Needles and their Containers
are marked with the
Company's Trade Mark "SIMANCO." 1**

**Needles in Containers marked
"For Singer Machines"
are not Singer made needles. 2**

NUMERICAL LIST OF PARTS
FOR
MACHINES
Nos. 147-50 and 147-51

NUMERICAL LIST OF PARTS

NO.	PLATE	NAME
144D	20503	Arm Rotary Shaft Screw.....
157J	20503	Feed Dog Screw.....
159E	20503	Arm Rotary Shaft Flanged Bushing Screw.....
161L	20504	Presser Bar Lifting Lever Extension (back) Screw.....
164J	20504	Thread Unwinder Thread Separator Bracket Arm Clamping Screw for 150060.....
164J	20504	Thread Unwinder Thread Separator Bracket Arm Screw for 150087.....
175E	20521	Looper Carrier Adjusting Screw for 54027.....
175E	20521	Looper Carrier Driver Cap Screw for 68479.....
175E	20521	Slack Thread Regulator Holder Clamp- ing Screw for 54042.....
176E	20503	Oil Pipe (back of arm) Clamp Screw...
176J	20503	Presser Bar Lifting Lever Extension (front) Screw.....
176J	20503	Feed Connecting Rod Cover Screw for 147-50 Machine.....
176J	20503	Needle Guard Holder Screw.....
187E	20523	" Bar Connecting Stud Clamping Screw for 68491.....
190J	20524	Presser Foot Screw.....
190J	20524	Slack Thread Controller Clamp Screw..
190J	20524	Thread (under) Eyelet (back) Screw...
190J	20524	" " Take-up Staple Spring Screw.....
190J	20524	Thread (under) Take-up Stripper Screw
190J	20524	" (upper) Eyelet Screw.....
198E	20524	Oil Pipe (back of arm) Connection Cap Screw for 68491.....
198E	20524	Oil Pipe (front of arm) Connection Cap Screw for 131002, 131003 and 131084
207E	20503	Feed Bar Wearing Plate Screw for 68464
208E	20522	Thread Unwinder Thread Guide Rod Screw for 225324.....
211F	20523	Thread (upper) Take-up Set Screw for 68491.....
217C	20503	Needle Guard Screw.....

NO.	PLATE	NAME
217j	20503	Feed Eccentric Clamping Washer Screw for 54025 and 68474.....
229j	20521	Looper Needle Guard Screw for 131134
286b	20503	Face Plate (upper half) Thumb Screw..
286d	20503	Guide Thumb Screw.....
286j	20503	Arm Side Cover Cap Thumb Screw for 131278.....
316c	9924	Tension (upper thread) Releasing Shaft Stop Screw.....
330d	20503	Face Plate (lower half) Screw.....
356c	20504	Rock Shaft Knee Arm Hub Set Screw for 2766.....
356c	20504	Rock Shaft Knee Plate Set Screw for 2767.....
356c	20504	Rock Shaft Lifting Bracket Hook Set Screw for 6337.....
356c	20504	Rock Shaft Lifting Bracket Set Screw for 6337.....
356c	20504	Rock Shaft Stop Dog Set Screw for 2770
376j	9924	Tension (upper thread) Bracket Screw
389f	20503	Cloth Plate Thread Guard Screw (lower) for 147-51 Machine.....
422c	20503	Arm Rotary Shaft Bushing (intermediate) Set Screw (long).....
423c	20503	Arm Rock Shaft Bushing (intermediate) Set Screw.....
443c	20503	Arm Rock Shaft Crank (front) Set Screw for 68439, obsolete.....
443c	20503	Looper Throw-out Handle Set Screw for 68485.....
446c	20503	Arm Rock Shaft Bushing (back) Set Screw.....
447c	20522	Presser Bar Guide Bracket Guide Set Screw.....
453c	20503	Arm Rock Shaft Flanged Bushing (front) Set Screw.....
453c	20503	Feed Rocking Frame Hinge Pin Bushing Set Screw.....
453c	20503	Feed Rocking Frame Hinge Pin Set Screw for 131240.....
453c	20503	Presser Bar Guide Bracket Set Screw for 54039.....
460c	20520	Thread (under) Take-up Thread Guard Steady Pin Set Screw for 131157..
462c	20522	Presser Bar Lifting Bracket Connection Connecting Pin Set Screw for 131007

NO.	PLATE	NAME
465c	20524	Thread (under) Nipper Cam Set Screw for 131184.....
574w	20524	Pressure Regulating Thumb Screw.....
590d	20524	Thread (under) Take-up Staple Thread Guard Screw for 38478.....
624c	9924	Tension (upper thread) Releasing Shaft Crank Set Screw for 54047.....
640e	20503	Looper Driving Shaft and Feed Lifting Eccentric Screw for 68441 and 131105
640j	20503	Presser Bar Guide Bracket Adjusting Screw for 54039.....
691f	9924	Tension (under thread) Bracket Screw.
725j	20503	Cloth Plate Slide (left) Spring Screw for 131051.....
725j	20503	Cloth Plate Slide (right) Spring Screw for 54015 and 131261.....
735c	20523	Feed Bar Hinge Pin Collar Set Screw for 59343.....
742f	20504	Throat Plate Screw.....
761e	20503	Arm Rotary Shaft Bushing (front) Set Screw.....
761e	20503	Looper Driving Shaft and Feed Lifting Eccentric Bushing Position Screw for 68483.....
802d	20504	Presser Bar Lifting Lever Hinge Screw
853c	20523	Needle Bar Connecting Link Hinge Stud Set Screw for 68439 and 131295
857c	20523	Needle Set Screw for 54036.....
861c	20523	Needle Bar Connecting Link Hinge Stud Oil Plug Screw for 68490.....
896e	20503	Crank Connecting Rod Cap (lower) Screw for 68456.....
896e	20503	Feed Connecting Rod Cap Screw for 68468 and 131106.....
948d	20503	Looper Driving Shaft and Feed Lifting Eccentric Bracket Screw for 68427..
965d	20504	Thread (under) Take-up Staple Bracket Screw.....
1011f	20503	Cloth Plate Screw (left).....
1019c	20524	Slack Thread Regulator Holder Shaft Collar Set Screw for 24292.....
1053e	20504	Face Plate (upper half) Position Plate Screw.....
1057e	20503	Arm Bottom Cover Screw.....
1057e	20503	Crank Connecting Rod Cap (upper) Screw for 68457.....

NO.	PLATE	NAME
1057E	20503	Feed Connecting Rod Clamping Screw for 68468 and 131106.....
1057J	20503	Arm Side Cover Screw.....
1095F	20521	Cloth Plate Thread Guard Screw (upper) for 147-50 Machine.....
1103C	20503	Feed Regulating Screw for 54025 and 68474.....
1120C	20521	Looper Set Screw for 54035.....
1133E	20523	Needle Bar Bushing (lower) Set Screw.
1133E	20523	“ “ “ (upper) Set Screw.
1133E	20523	Presser Bar Bushing (lower) Set Screw.
1133E	20523	“ “ “ (upper) Set Screw
1235F	20503	Arm Rock Shaft Oil Plug Screw for 68432 and 131294.....
1235F	20503	Cloth Plate Thread Guard Screw (lower) for 147-50 Machine.....
1247C	20522	Machine Base Oil Drain Jar Clamp Lever Hinge Screw for 131268.....
1250C	20504	Presser Bar Lifter Stop Screw.....
1253C	20522	Slack Thread Regulator Holder Shaft Crank Set Screw for 54044.....
1258C	20524	Arm Rotary Shaft Collar Set Screw for 54450.....
1309C	20504	Arm Rock Shaft Adjusting Screw.....
1449J	20520	Thread (upper) Take-up Plate Spring Screw for 54195.....
1520J	20523	Needle Bar Connecting Link Hinge Stud Nut.....
1539W	20524	Pressure Regulating Thumb Screw Lock Nut.....
1547J	9924	Tension (upper thread) Releasing Shaft Stop Screw Nut.....
1722E	20503	Crank Connecting Rod Nut (lower) for 68458.....
1723E	20503	Crank Connecting Rod Nut (upper) for 68458.....
1733	20524	Oil Pipe (back of arm) Coupling Nut (brass).....
1733	20524	Oil Pipe (front of arm) Coupling Nut (brass) for 68498 and 68500.....
1963	20522	Presser Bar Guide Bracket Roller and Stud for 54039.....
2102	9924	Tension (upper thread) Disc.....
2102	9924	“ (under thread) Disc.....
2417	20504	Arm Rock Shaft Crank (front) Pin, obsolete.....
2763	20508	Rock Shaft for 23767.....

NO.	PLATE	NAME
2766	20508	Rock Shaft Knee Arm Hub with 356c, for 6336.....
2767	20508	Rock Shaft Knee Plate with 356c, for 6336.....
2770	20508	Rock Shaft Stop Dog with 356c, for 23767.....
4822	8941	Wrench for 1547 (Accessories).....
4879	8941	Chain Connecting Link.....
4882	8941	Treadle Shaft for 126252.....
6335	20508	Rock Shaft Knee Arm for 6336.....
6336	—	Rock Shaft Knee Arm complete, Nos. 2766, 2767 and 6335, for 23767.....
6337	20508	Rock Shaft Lifting Bracket with two 356c, for 23767.....
6439	—	Chain, 36 in. to 45 in., with 56864 and 56865.....
7071	20520	Feed Eccentric Clamping Washer for 54025 and 68474.....
7125	20508	Rock Shaft Lifting Bracket Hook for 23767.....
8908	8941	Wrench for 1520 (Accessories).....
9525	20524	Thread Unwinder Thread Separator Bracket Arm Clamping Screw Washer for 150060.....
9525	20524	Thread Unwinder Thread Separator Bracket Arm Screw Washer for 150087.....
9842	20504	Machine Base Screw Stud Nut Washer for 131264.....
11173	20522	Presser Bar Guide Bracket Guide.....
12242	20508	Rock Shaft Hanger with two wood screws 1 in. No. 10, for 23767.....
*15404	—	Trade Mark for 68427.....
15405	—	“ “ Rivet for 68427.....
*23729	—	Feed Eccentric Body for 54025.....
23767	20508	Rock Shaft complete, Nos. 2763, 2770, 6336, 6337, 7125 and two 12242.....
24292	20524	Slack Thread Regulator Holder Shaft Collar with 1019c.....
25303	20523	Presser Bar Ball, size ¼ in., for 64330..
25618	20522	Guide.....
26026	8941	Screw Driver (large) Accessories.....
26276	20525	Presser Foot Hinge Pin for 46058.....
26485	8941	Screw Driver (small) Accessories.....
27739	20527	Thread Unwinder Thread Cone (wood) for large cones.....

NO.	PLATE	NAME
27998	20505	Bench Stand Flap Hook and Eye (brass) with wood screw $\frac{1}{2}$ in. No. 5, for 79772.
29234	20504	Face Plate (upper half) Position Plate.
32572	9924	Tension (upper thread) Releasing Disc
37563	—	Chain, length 15 in., with 56864 and 56865.
38419	20504	Cloth Plate Slide (right) Spring for 54015 and 131261.
38456	20523	Presser Bar Bushing (upper).
38467	20502	“ “ Spring (flat).
38468	20524	“ “ “ Stud.
38478	20524	Thread (under) Take-up Staple with two each 590b and 38481.
38481	20524	Thread (under) Take-up Staple Thread Guard for 38478.
38484	20520	Thread (upper) Eyelet.
38486	20525	Throat Plate for 54177.
38487	8941	Threading Wire (Accessories).
41128	9922	Arm Rotary Shaft Bushing (intermediate) Oil Pad (braided cotton) for 68444.
41538	—	Bench Stand Flush Bolt with Plate complete, for 79772, Nos. 126247, 126248 and four brass wood screws $\frac{5}{8}$ in. No. 4.
42365	9922	Arm Rock Shaft Oil Pad (braided cotton) for oiling Back Bearing.
42367	9922	Arm Rotary Shaft Flanged Bushing Oil Pad (braided cotton) for 68446.
42367	9922	Arm Rotary Shaft Front Bearing Oil Pad, lower (braided cotton).
43503	20504	Looper Throw-out Handle Plunger Spring.
46041	20520	Thread (under) Take-up Staple Spring
46056	—	Presser Foot Plate for 46058.
46057	—	“ “ Shank for 46058.
46058	20525	Presser Foot (hinged) complete, Nos. 26276, 46056 and 46057.
46105	20521	Looper Needle Guard Pin for 131135.
*49189	—	Oil Pipe (back of arm) Connection Cap for 68494.
*49189	—	Oil Pipe (front of arm) Connection Cap for 131003.
*49191	—	Oil Pipe (back of arm) Sleeve for 68492
*49191	—	“ “ (front of arm) Sleeve for 68498 and 68500.

NO.	PLATE	NAME
50083c	20503	Arm Rock Shaft Crank (back) Set Screw for 131072.
50084c	20503	Arm Rotary Shaft Bushing (intermediate) Set Screw (short).
50150c	20524	Slack Thread Regulator Set Screw for 54042.
50152a	20521	Feed Connecting Rod Cover Screw for 147-51 Machine.
50326c	9924	Tension (under thread) Screw Stud for 59539.
50326c	9924	Tension (upper thread) Screw Stud for 59539.
50396f	20503	Cloth Plate Screw (right).
50429c	20503	Feed Dog Stop Screw for 68464.
50473f	20503	Cloth Plate Thread Guard Screw (upper) for 147-51 Machine.
50592c	20504	Presser Bar Lifter Hinge Screw.
51061c	20503	Feed Eccentric Body Set Screw for 54025 and 68474.
51119a	20503	Looper Holder Screw.
51263d	20521	“ Carrier Connection Shaft Sleeve Cap Screw.
51283c	20503	Balance Wheel Set Screw for 64259
51334c	20524	Thread (under) Take-up Set Screw for 131014.
51570c	9924	Tension (under thread) Regulating Thumb Nut for 59539.
51570c	9924	Tension (upper thread) Regulating Thumb Nut for 59539.
51576e	20504	Machine Base Screw Stud Nut for 131264.
52045	9922	Arm Rock Shaft Bushing (back) Oil Pad (wick) for 68434.
52045	9922	Arm Rock Shaft Bushing (intermediate) Oil Pad (wick) for 68437.
52045	9922	Arm Rock Shaft Flanged Bushing (front) Oil Pad (wick).
53225	9924	Thread (under) Eyelet (back).
54014	20527	Cloth Plate Slide (right) for 54015.
54015	—	Cloth Plate Slide (right) complete, for 131081, Nos. 38419, 54014 and two 725j.
*54018	—	Crank Connecting Rod Cap (upper) for 68457.
*54024	—	Feed Eccentric for 54025.
54025	20527	Feed Eccentric (adjustable) complete, for 131108, Nos. 217j, 1103c, 7071, 23729, 54024 and two 51061c.

NO.	PLATE	NAME
54027	20521	Looper Carrier with two 175e, for 68482 and 131111.....
54035	20521	Looper Holder with 1120c.....
54036	20523	Needle Bar (hollow) with 857c.....
54037	20522	“ Guard.....
54038	20522	Needle Guard Holder.....
54039	20522	Presser Bar Guide Bracket with 453c, 640i and 1963.....
54041	20524	Slack Thread Regulator.....
54042	20524	“ “ “ Holder with 175e and two 50150c.....
54044	20521	Slack Thread Regulator Holder Shaft Crank (forked) with 1253c.....
54045	20527	Tension (upper thread) Bracket.....
54046	20527	“ “ “ Releasing Shaft.....
54047	9924	“ “ “ “ “ Crank with 624c.....
54048	9924	Tension (upper thread) Releasing Shaft Crank Link.....
54105	9916	Arm Rock Shaft Flanged Bushing (front).....
54177	20525	Feed Dog, 16 teeth (16 teeth to the inch) for 38486.....
54193	20520	Thread (upper) Take-up for 54195.....
54194	20520	“ “ “ Plate for 54195.....
54195	—	Thread (upper) Take-up complete, Nos. 1449i, 54193, 54194 and 68164.....
54218	9922	Arm Rotary Shaft Front Peering Oil Pad, upper (braided cotton).....
54227	20521	Looper Carrier Connection for 68482 and 131111.....
54228	20521	Looper Carrier Connection Shaft for 68482 and 131111.....
54242	20524	Slack Thread Controller Clamp.....
54249	20525	Feed Dog, 20 teeth (16 teeth to the inch) for binding, for 131255.....
54450	20520	Arm Rotary Shaft Collar with two E258c, for 68441 and 131105.....
*54455	—	Feed Eccentric Body for 68474.....
54477	20504	Machine Base Screw Stud, to fasten base to table, for 131264.....
54648	9922	Arm Oil Cup Oil Pad (braided cotton) for 68464.....
54648	9922	Feed Bar Oil Pad (braided cotton) for 68464.....
54969	9922	Arm Rock Shaft Oil Pad (braided cotton) for oiling Intermediate Bearing.....

NO.	PLATE	NAME
54988	9924	Tension (upper thread) Releasing Pin.....
56006	9922	Arm Rotary Shaft Oil Pad (braided cotton) for oiling Intermediate Bearing.....
56864	8941	Chain Hook (large) for 6439 and 37563.....
56865	20505	“ “ (small) for 6439 and 37563.....
57076	9924	Tension (under thread) Thread Guide (double).....
57076	9924	Tension (upper thread) Thread Guide (double).....
57234	20502	Feed Rocking Frame Hinge Pin.....
57235	20520	“ “ “ “ “ Bushing.....
57257	20504	Presser Bar Lifter.....
57285	—	Machine Cushion (felt) obsolete.....
57974	9922	Arm Rotary Shaft Oil Pad (braided cotton) for oiling Back Bearing.....
59343	20520	Feed Bar Hinge Pin Collar with 735c, for 131196.....
59534	9924	Tension (under thread) Spring.....
59535	9924	“ (upper thread) Spring.....
59537	9924	“ (under thread) Spring Bushing (large).....
59537	9924	Tension (upper thread) Spring Bushing (large).....
59538	9924	Tension (under thread) Spring Bushing (small).....
59538	9924	Tension (upper thread) Spring Bushing (small).....
59539	—	Tension (under thread) Screw Stud 50326c with 51570c.....
59539	—	Tension (upper thread) Screw Stud 50326c with 51570c.....
60656	20505	Bench Stand Hinge for 79772.....
61075	20522	Presser Bar Lifting Bracket Connection Connecting Pin.....
64259	20508	Balance Wheel, 2 in. Pulley, with two 51283c.....
64315	20524	Looper Driving Shaft and Feed Lifting Eccentric Oil Hole Plug for 68481 and 131110.....
64320	20523	Needle Bar Bushing (upper).....
64330	20502	Presser Bar with 25303.....
64356	20520	Thread (under) Take-up Thread Guard Steady Pin.....
68164	20520	Thread (upper) Take-up Plate Spring for 54195.....
68184	20502	Presser Bar Lifting Lever Extension (back).....

NO.	PLATE	NAME
68222	20509	Belt Guard with two wood screws 1 in. No. 12.....
68261	9924	Tension (upper thread) Releasing Shaft Spring.....
68350	9922	Arm Oil Cup, for oiling Arm Rock Shaft Front Bearing.....
68368	9918	Cloth Plate Slide (left) for 131051.....
*68427	—	Arm, upper and lower (solid) with 948D, 15404, 68483, two 15405 and four 131022.....
68428	9917	Arm Bottom Cover.....
68429	9917	“ “ “ Gasket (cork).....
68430	9922	“ Oil Cup, for filling Oil Reservoir...
68431	9916	“ Rock Shaft for 68432, obsolete, superseded by 131293, not inter- changeable.....
68432	—	Arm Rock Shaft 68431 with 1235E and 68439, obsolete, use 131294.....
68433	9916	Arm Rock Shaft Bushing (back) for 68434.....
68434	—	Arm Rock Shaft Bushing (back) 68433 with 52045.....
68435	9916	Arm Rock Shaft Bushing (back) Cap...
68436	9916	“ “ “ “ (intermediate) for 68437.....
68437	—	Arm Rock Shaft Bushing (intermediate) 68436 with 52045.....
68439	9916	Arm Rock Shaft Crank (front) with 443c and 853c, for 68432, obsolete, superseded by 131295, not inter- changeable.....
*68440	20508	Arm Rotary Shaft for 68441.....
68441	—	“ “ “ “ 68440 with 640E, 54450, 68459, 68470, 68482 and 131016, for I-47-50 Machine.....
68442	20520	Arm Rotary Shaft Bushing (front).....
68443	9917	“ “ “ “ (intermedi- ate) for 68444.....
68444	—	Arm Rotary Shaft Bushing (intermediate) 68443 with 41128.....
68445	9917	Arm Rotary Shaft Flanged Bushing for 68446.....
68446	—	Arm Rotary Shaft Flanged Bushing 68445 with 42367.....
68447	9917	Arm Side Cover, obsolete, use 131278..
68448	9917	“ “ “ Gasket (cork).....
68449	20508	Cloth Plate for 131081.....

NO.	PLATE	NAME
68452	9916	Crank Connecting Rod (rod only) for 68458.....
*68453	—	Crank Connecting Rod Cap (lower) for 68456.....
*68454	—	Crank Connecting Rod End Bearing (lower) for 68456.....
*68455	—	Crank Connecting Rod End Bearing (upper) for 68457.....
68456	9916	Crank Connecting Rod Head (lower), Nos. 68453, 68454 and two 896E, for 68458.....
68457	9916	Crank Connecting Rod Head (upper), Nos. 54018, 68455 and two 1057E, for 68458.....
68458	9916	Crank Connecting Rod complete, for 68459, Nos. 1722E, 1723E, 68452, 68456 and 68457.....
68459	—	Crank Connecting Rod 68458 with 131072, for 68441 and 131105.....
68460	9918	Face Plate (lower half).....
68461	9918	“ “ “ Gasket (cork)...
68462	9918	“ “ (upper half).....
68463	9918	Feed Bar for 68464.....
68464	9918	Feed Bar complete for 131196, Nos. 50429c, 54648, 68463, 68467 and two 207E.....
68467	9918	Feed Bar Wearing Plate for 68464.....
68468	9918	“ Connecting Rod with 1057E, 68469, 131090, 134260 and two 896E, for 68470.....
*68469	—	Feed Connecting Rod Cap for 68468...
68470	—	“ “ “ “ 68468 with 68474, for 68441.....
68471	9918	Feed Connecting Rod Cover.....
*68473	—	“ Eccentric for 68474.....
68474	9918	Feed Eccentric (adjustable) complete for 68470, Nos. 217J, 1103c, 7071, 54455, 68473 and two 51061c.....
68478	20521	Looper Carrier Connection Shaft Sleeve (eccentric).....
68479	20521	Looper Carrier Driver with 68480 and four 175E, for 68482 and 131111.....
*68480	—	Looper Carrier Driver Cap for 68479...
*68481	20502	“ Driving Shaft and Feed Lifting Eccentric with two 64315, for 68482..
*68482	—	Looper Driving Shaft and Feed Lifting Eccentric 68481 with 54027, 54227, 54228 and 68479, for 68441.....

NO.	PLATE	NAME
*68483	—	Looper Driving Shaft and Feed Lifting Eccentric Bracket with 761E, for 68427.....
68484	20502	Looper Driving Shaft and Feed Lifting Eccentric Bushing.....
68485	20502	Looper Throw-out Handle with two 443c.....
68486	20502	Looper Throw-out Handle Plunger.....
68487	20523	Needle Bar Bushing (lower), obsolete, use 131291.....
68488	20523	Needle Bar Connecting Link and Thread (upper) Controller.....
68489	20523	Needle Bar Connecting Link Hinge Stud (hollow) for 68490.....
68490	—	Needle Bar Connecting Link Hinge Stud 68489 with 861c and 131270.....
68491	20523	Needle Bar Connecting Stud with 211f and two 187e.....
68492	9921	Oil Pipe (back of arm) with 49191 and 68497, for oiling Feed Rocking Frame Hinge Pin Front Bearing.....
68493	9921	Oil Pipe (back of arm) Clamp.....
68494	9921	“ “ “ “ “ Connection with 49189, 68495 and two 198E, for oiling Feed Rocking Frame Hinge Pin Back Bearing.....
68495	9922	Feed Bar Slide Block Oil Pad (wick) for 131259.....
68495	9922	Oil Pipe (back of arm) Connection Oil Pad (wick) for 68494.....
68496	9921	Oil Pipe (back of arm) Coupling.....
68497	9922	Looper Driving Shaft and Feed Lifting Eccentric Front Bearing Oil Pad (wick).....
68497	9922	Oil Pipe (back of arm) Oil Pad (wick) for 68492.....
68497	9922	Oil Pipe (front of arm) Oil Pad (wick) for 131001, 131112 and 131113.....
68498	9921	Oil Pipe (front of arm) with 131089 and two each 1733 and 49191, for oiling Looper Driving Shaft and Feed Lifting Eccentric Front Bearing (copper tubing) for 131257 and 131258.....
68500	9921	Oil Pipe (front of arm) with 1733, 49191, 131084 and 131089, for oiling Arm Rotary Shaft Front Bearing (copper tubing) for 131257 and 131258.....

NO.	PLATE	NAME
79772	—	Bench Stand with 27998, two each 41538, 126849, three wood screws 1¼ in. No. 12 four each 60656, wood screws 1¼ in. No. 10, eight wood screws ⅝ in. No. 6 and sixteen wood screws ⅝ in. No. 7.....
120341	8941	Tweezers (curved) Accessories.....
120344	8941	Oiler (copper plated) with 120345 (Accessories).....
120345	8941	Oiler Spout, 5 in. long, for 120344 (Accessories).....
124500	20505	Hinge for 79757, obsolete, superseded by 126849, not interchangeable.....
126247	20505	Bench Stand Flush Bolt for 41538.....
126248	20505	“ “ “ Plate for 41538.....
126249	20509	Treadle for 126252.....
126250	8941	“ Spring for 126252.....
126251	20509	“ Stand for 126252.....
126252	20509	Treadle complete, Nos. 4882, 126249 to 126251 and two wood screws 1 in. No. 16.....
126849	20522	Bench Stand Flap Hinge with four wood screws ¾ in. No. 7, for 79772.....
127838	—	Arm Rock Shaft Crank (front) Pin...
128419	9922	Looper Carrier Connection Shaft Oil Pad (braided cotton).....
131001	9921	Oil Pipe (front of arm) with 68497 and 131003, for oiling Feed Connecting Rod, for 131257.....
131002	9921	Oil Pipe (front of arm) Connection with 131049 and two 198E, for oiling Looper Throw-out Device.....
131003	9921	Oil Pipe (front of arm) Connection with 49189 and two 198E, for 131001, 131112 and 131113.....
131004	9921	Oil Pipe (front of arm) Coupling (center).....
131004	9921	Oil Pipe (front of arm) Coupling (left)...
131006	20523	Presser Bar Bushing (lower).....
131007	20522	“ “ Lifting Bracket with 462c..
131008	20522	“ “ “ “ Connection
131009	20502	“ “ “ Lever.....
131010	20502	“ “ “ “ Extension (front).....
131011	9924	Tension (upper thread) Releasing Shaft Spring Position Plate.....
131012	20502	Tension (under thread) Bracket.....

NO.	PLATE	NAME
131014	20524	Thread (under) Take-up with two 51334c.....
131016	20520	Thread (under) Take-up Thread Guard (brass) for 68441.....
131018	20509	Machine Base, obsolete, superseded by 131263.....
131019	20505	Machine Base Oil Pipe, obsolete.....
131020	20505	" " " " Valve, obsolete
131022	20504	Machine Base Screw Stud Bushing (rubber) for 68427.....
131025	20524	Slack Thread Controller.....
131028	20524	Looper Driving Shaft and Feed Lifting Eccentric Bushing Oil Plug.....
131042	20524	Slack Thread Regulator Holder Shaft..
*131049	---	Oil Pipe (front of arm) Connection Cap for 131002.....
131050	9918	Cloth Plate Slide (left) Spring for 131051.....
131051	---	Cloth Plate Slide (left) complete for 131081 and 131262, Nos. 68368, 131050 and two 725j.....
131056	20504	Arm Rock Shaft Adjusting Screw Washer.....
131072	9916	Arm Rock Shaft Crank, back (ball bearing, solid) with two 50083c, for 68459.....
131079	20521	Looper (closed eye) for 147-50 Machine
131080	20524	Thread (under) Eyelet (front).....
131081	---	Cloth Plate complete for 38486, Nos. 54015, 68449 and 131051.....
131084	9921	Oil Pipe (front of arm) Connection with 131085 and two 198E, for 68500.....
*131085	---	Oil Pipe (front of arm) Connection Cap for 131084.....
*131086	---	Oil Pipe (front of arm) Coupling (right) for 131087.....
131087	9921	Oil Pipe (front of arm) Coupling (right) 131086 with 131088.....
*131088	---	Oil Pipe (front of arm) Coupling (right) Oil Lead for 131087.....
131089	9922	Oil Pipe (front of arm) Oil Pad (wick) for 68498 and 68500.....
131090	9922	Feed Connecting Rod Oil Pad (wick) for 68468 and 131106.....
131095	9916	Arm Rock Shaft Bushing (back) Cap Washer (fibre).....
131096	20520	Thread (under) Take-up Stripper.....

NO.	PLATE	NAME
*131104	20508	Arm Rotary Shaft for 131105.....
131105	---	" " " 131104 with 640E, 54450, 68459, 131108, 131111, 131184 and 131194, for 147-51 Machine.....
131106	20527	Feed Connecting Rod with 1057E, 131090, 131107, 134260 and two 896E, for 131108.....
*131107	---	Feed Connecting Rod Cap for 131106..
131108	---	" " " 131106 with 54025 for 131105.....
131109	20520	Feed Connecting Rod Cover Spacing Washer for 147-51 Machine.....
131110	20527	Looper Driving Shaft and Feed Lifting Eccentric with two 64315, for 131111
131111	---	Looper Driving Shaft and Feed Lifting Eccentric 131110 with 54027, 54227, 54228 and 68479, for 131105.....
131112	9921	Oil Pipe (front of arm) with 68497 and 131003, for oiling Feed Bar Slide Block, for 131257 and 131258.....
131113	9921	Oil Pipe (front of arm) with 68497 and 131003, for oiling Feed Connecting Rod, for 131258.....
131130	20508	Cloth Plate Thread Guard.....
131133	20521	Looper (closed eye) for 131134.....
131134	---	" 131133 with 229j and 131135, for 147-51 Machine.....
131135	20521	Looper Needle Guard with 46105, for 131134.....
131157	20527	Thread (under) Take-up Staple Bracket with 460c.....
131184	20520	Thread (under) Nipper Cam with 465c, for 131105.....
131185	20526	Machine Base Oil Drain Jar (glass) for 131268.....
131188	20526	Machine Base Oil Drain Jar Clamp for 131217.....
131189	20526	Machine Base Oil Drain Jar Clamp Lever for 131217.....
131191	20526	Machine Base Oil Drain Jar Cap for 131268.....
131194	20520	Thread (under) Take-up Thread Guard (brass) for 131105.....
131195	---	Feed Rocking Frame with two 453c, for 131196, obsolete, use 131240.....
131196	---	Feed Rocking Frame 131240 with 59343, 68464 and 131197.....

NO.	PLATE	NAME
131197	9918	Feed Bar Hinge Pin (eccentric) for 131196.....
131205	20504	Machine Base Screw Stud, to position machine on base, for 131264.....
131217	—	Machine Base Oil Drain Jar Clamp 131188 with 131189, for 131268.....
131240	20502	Feed Rocking Frame with two 453c, for 131196.....
131255	20525	Throat Plate, for binding, for 54249....
131257	—	Oil Pipe (front of arm) complete for 147-50 Machine, Nos. 68498, 68500, 131001 and 131112.....
131258	—	Oil Pipe (front of arm) complete for 147-51 Machine, Nos. 68498, 68500, 131112 and 131113.....
131259	—	Cloth Plate for 131262.....
131260	20527	" " Slide (right) for 131261....
131261	—	Cloth Plate Slide (right) complete for 131262, Nos. 38419, 131260 and two 725.....
131262	—	Cloth Plate complete, for binding, for 131255, Nos. 131051, 131259 and 131261.....
131263	20528	Machine Base for 131264.....
131264	—	Machine Base complete, Nos. 131263, three each 9842, 51576e, 54477 and four each 131205 and 131279.....
131265	20526	Machine Base Oil Drain Jar Nipple (long) for 131268.....
131266	20526	Machine Base Oil Drain Jar Nipple (short) for 131268.....
131267	20526	Machine Base Oil Drain Jar Nipple Elbow for 131268.....
131268	—	Machine Base Oil Drain Jar (swinging type) complete, Nos. 131185, 131191, 131217, 131266 and two each 1247c, 131265 and 131267.....
131270	20523	Needle Bar Connecting Link Hinge Stud Nut Oil Pad (wick) for 68490....
131276	20526	Arm Side Cover (oil vent) for 131278....
131277	20526	" " " Cap for 131278.....
131278	—	Arm Side Cover (oil vent) complete, Nos. 286a, 131276, 131277 and 131280
131279	20527	Machine Cushion (felt) for 131264.....
131280	20520	Arm Side Cover Cap Steady Pin for 131278.....
131291	—	Needle Bar Bushing (lower).....

NO.	PLATE	NAME
131293	—	Arm Rock Shaft for 131294.....
131294	—	" " " " 131293 with 1235f and 131295.....
131295	—	Arm Rock Shaft Crank (front) with 853c, for 131294.....
134258	9918	Feed Bar Slide Block for 134259.....
134259	9918	" " " " 134258 with 68495 and 134260.....
134260	9922	Feed Bar Slide Block Oil Pad Retainer for 134259.....
134260	9922	Feed Connecting Rod Oil Pad Retainer for 68468 and 131106.....
*150059	—	Thread Unwinder Thread Separator Bracket for 150086.....
150060	20787	Thread Unwinder Thread Separator Bracket Arm with 164j and 9525, for 150087.....
*150085	—	Thread Unwinder Thread Separator for 150086.....
150086	20787	Thread Unwinder Thread Separator 150085 with 150059, for 150087.....
150087	—	Thread Unwinder Thread Separator complete for 150088, Nos. 164j, 9525, 150060 and 150086.....
150088	20787	Thread Unwinder complete, Nos. 150087, 201696j, 202490, 225257, 225324, 225326, 225388, two each 150203, 225391 and three wood screws $\frac{3}{8}$ in. No. 12.....
150203	20509	Thread Unwinder Spool Rest Cushion (felt) for 150088.....
200383c	20523	Thread Unwinder Spool Rest Rod Set Screw for 202490.....
201018c	20504	Thread Unwinder Spool Rest Set Screw for 225257.....
201696j	20504	Thread Unwinder Thread Guide Lock Nut for 150088.....
202490	20787	Thread Unwinder Spool Stand with 200383c, for 150088.....
225257	20787	Thread Unwinder Spool Rest (for two spools) with 201018c for 150088.....
225322	20504	Thread Unwinder Thread Guide Rod Washer for 225324.....
225324	20787	Thread Unwinder Thread Guide Rod with 208e and 225322, for 150088....
225326	20504	Thread Unwinder Thread Guide Position Cup for 150088.....

NUMERICAL LIST OF PARTS

NO.	PLATE	NAME
225388	20787	Thread Unwinder Spool Rest Rod for 150088.....
225390	20527	Thread Unwinder Thread Cone Holder, for inverted cones.....
225391	20787	Thread Unwinder Thread Guide for 150088.....

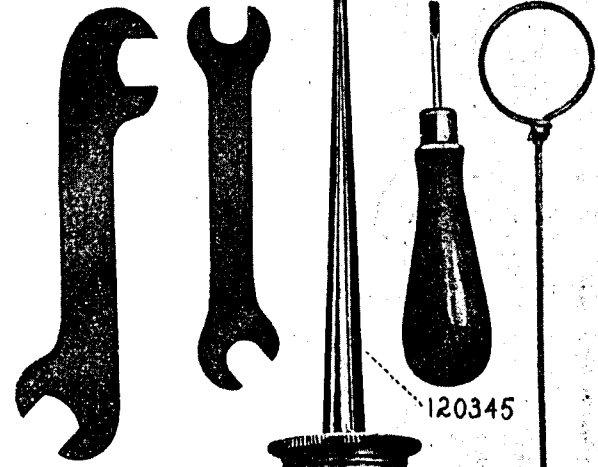
**Genuine Singer Needles should be used
in Singer Machines.
These Needles and their Containers
are marked with the
Company's Trade Mark "SIMANCO." 1**

**Needles in Containers marked
"For Singer Machines"
are not Singer made needles. 2**

**ILLUSTRATIONS OF PARTS
FOR
MACHINES
Nos. 147-50 and 147-51**

PLATE 8941—ONE-HALF SIZE

19221 8908 120344 26485 38487



4822



120345

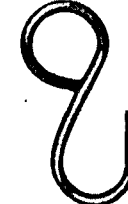
26026



120341



4879



56864



126250



4882



PLATE 9916—ONE-HALF SIZE

68431



68433



131095



131072



68435



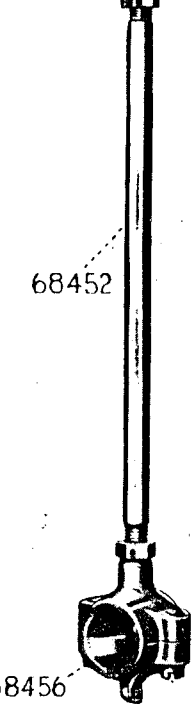
68458



68436



68457



54105



68452

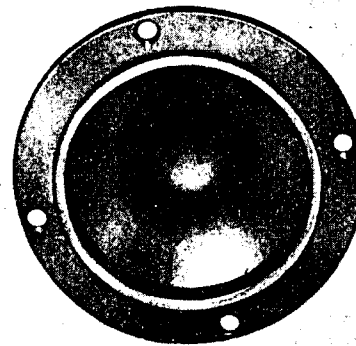
68439



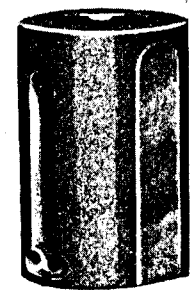
68456

PLATE 9917—ONE-HALF SIZE

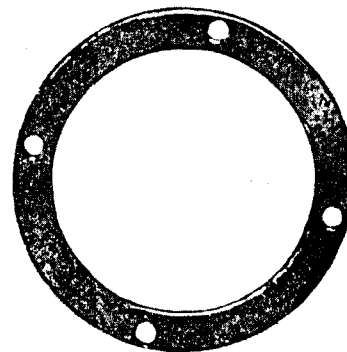
68428



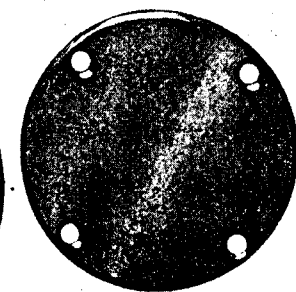
68443



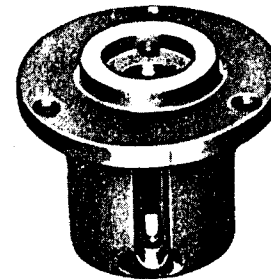
68429



68447



68445



68448

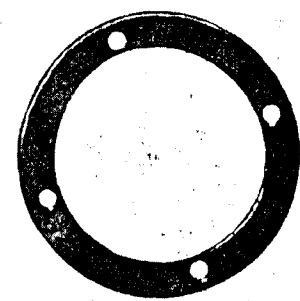


PLATE 9918—ONE-HALF SIZE

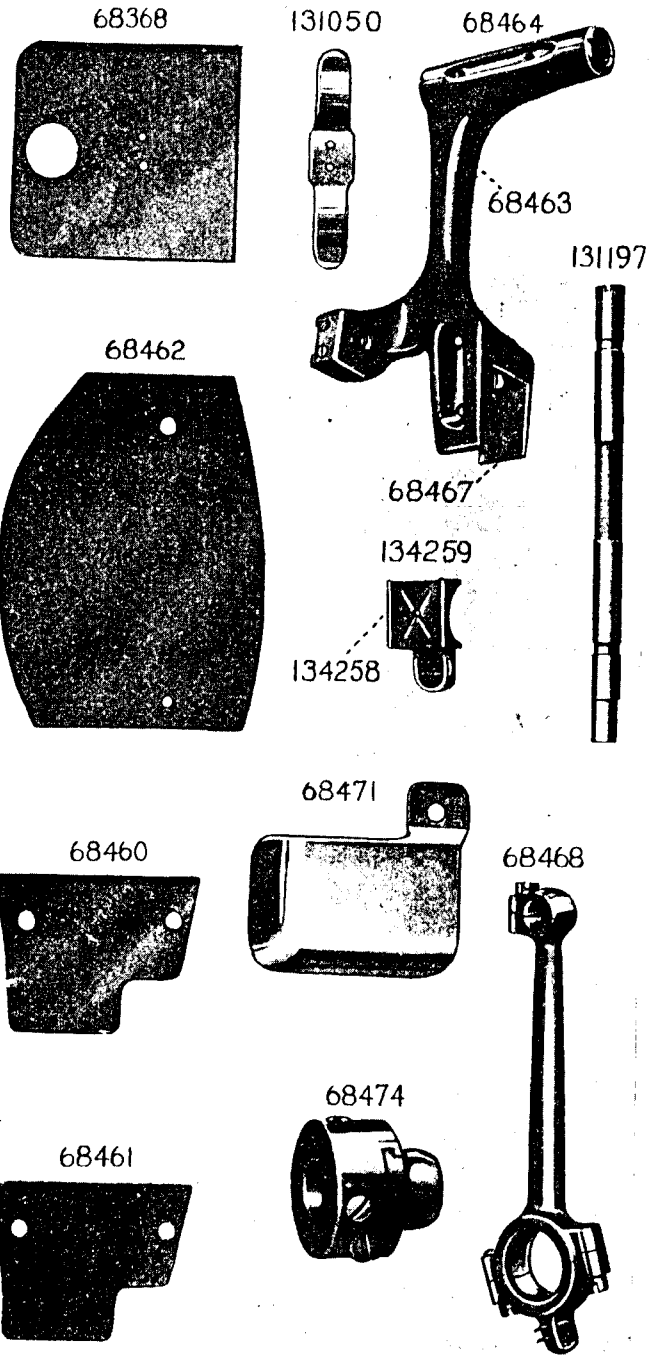


PLATE 9921—ONE-HALF SIZE

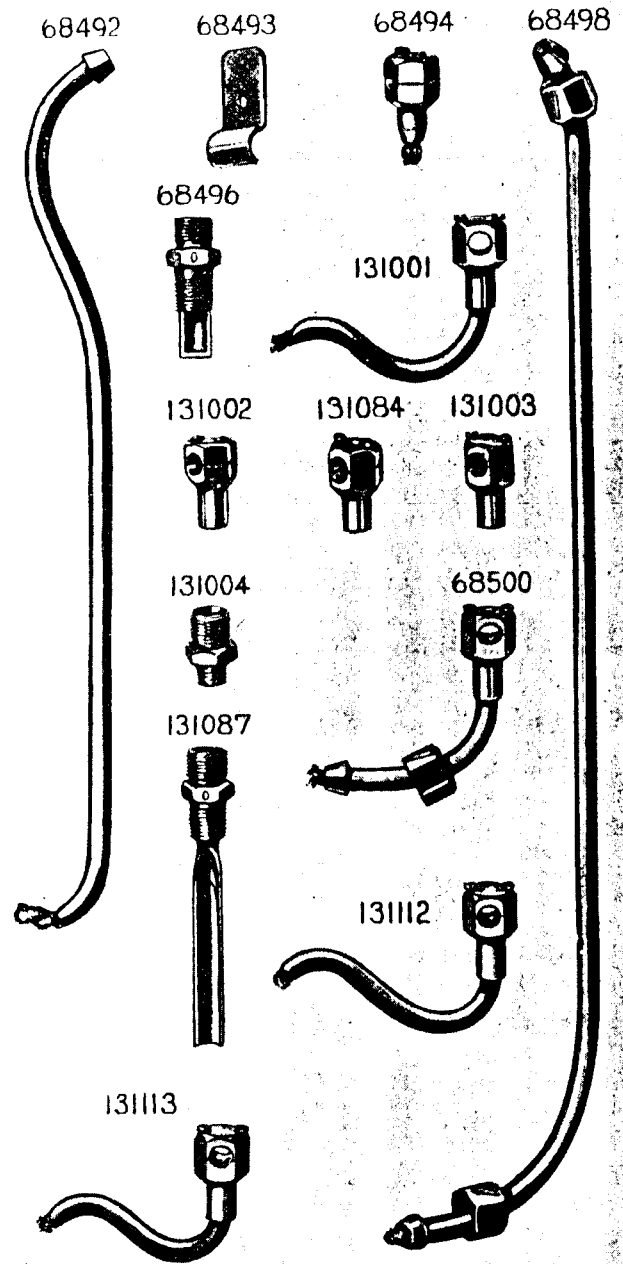
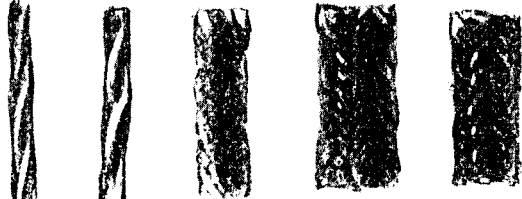


PLATE 9922—FULL SIZE

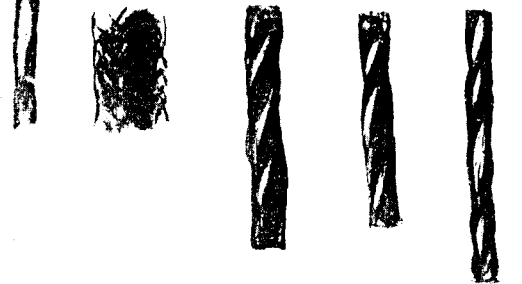
41128 54218 42367 54969 42365



68497 131090 56006 57974 54648



128419 52045 68495 131089



68430 134260 68350

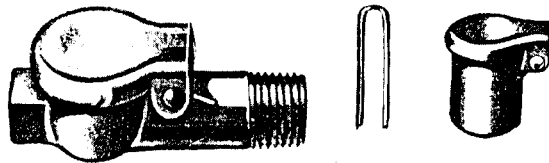
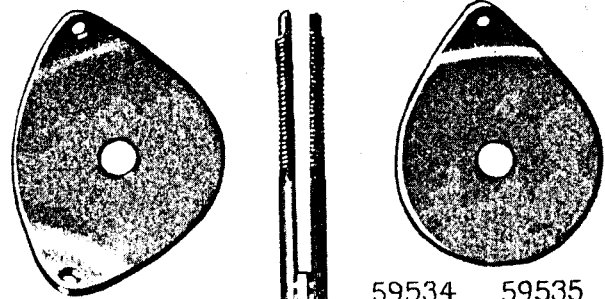
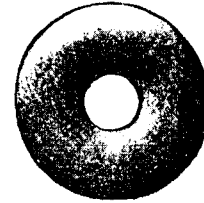


PLATE 9924—FULL SIZE

57076 50326 17547



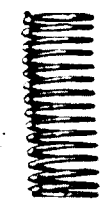
2102



51570



59534



59535



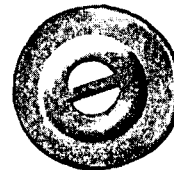
59538



59537



32572



54988



316



376



54047



53225



691

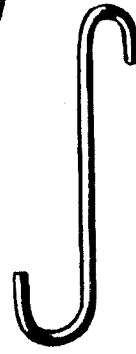


1547

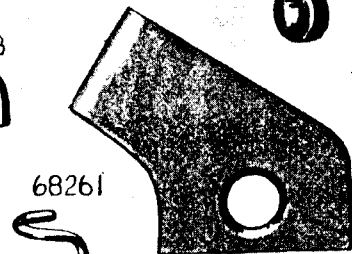


131011

54048



68261



624

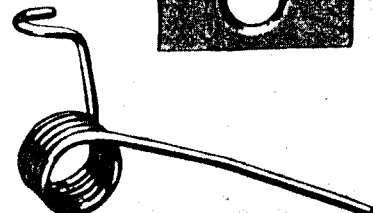


PLATE 20502—ONE-HALF SIZE

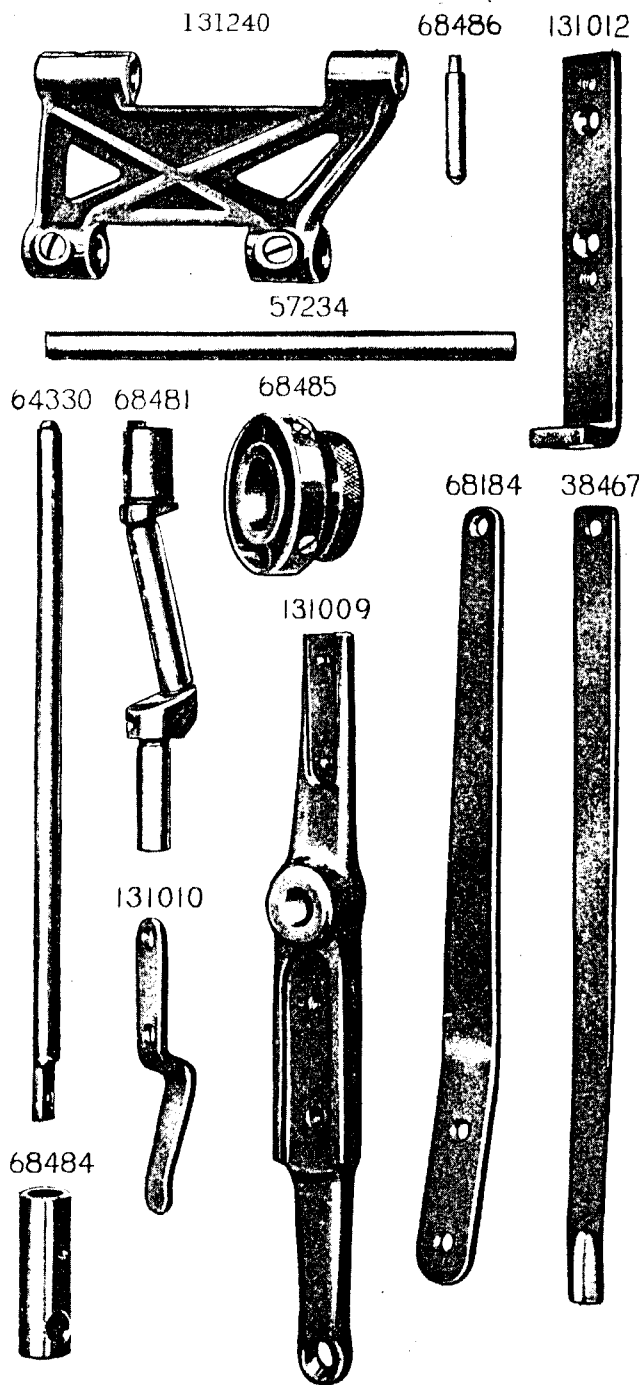


PLATE 20503—FULL SIZE

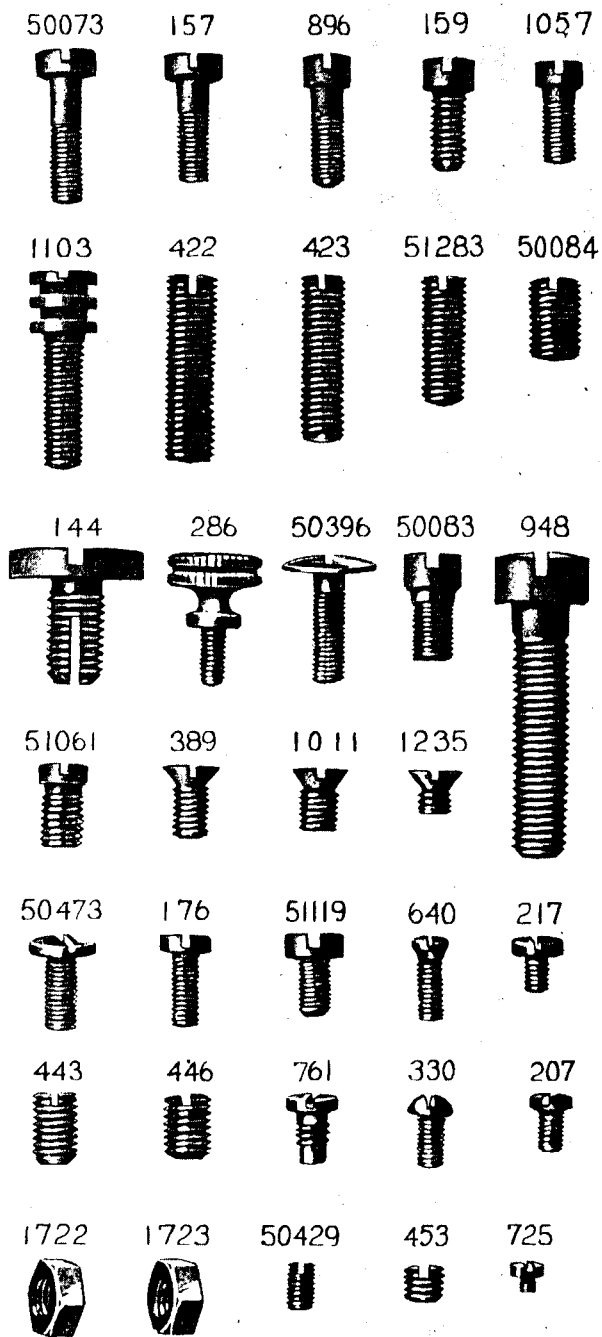


PLATE 20504—FULL SIZE

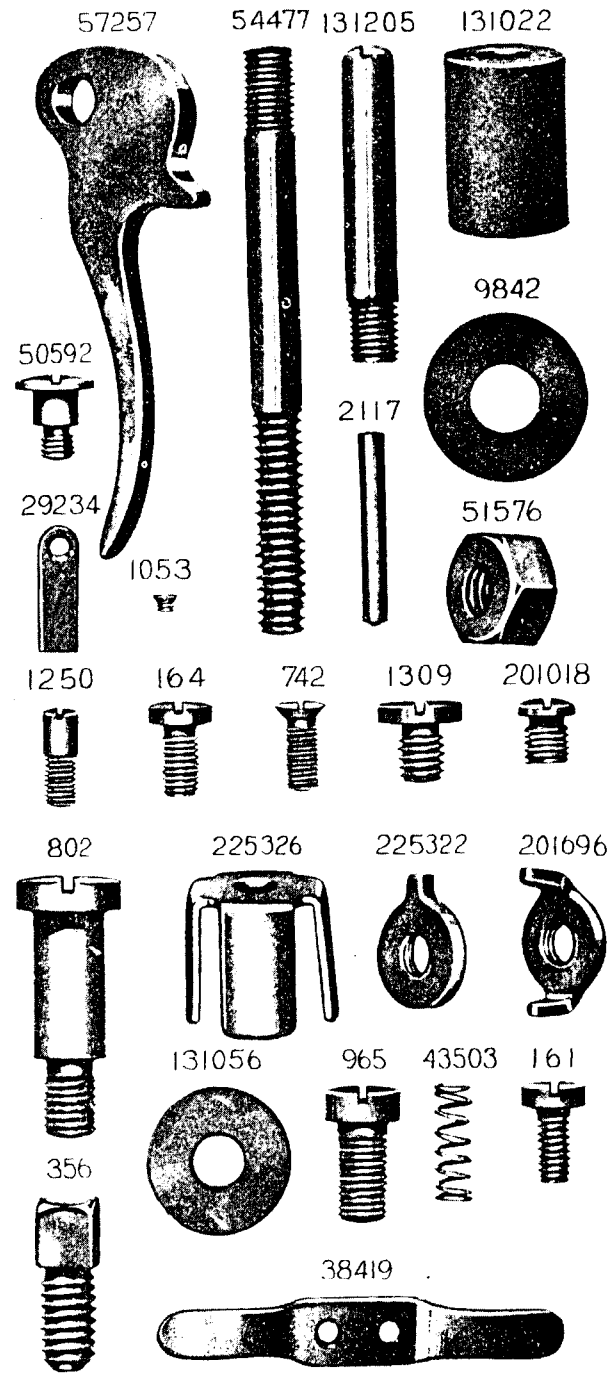


PLATE 20505—FULL SIZE

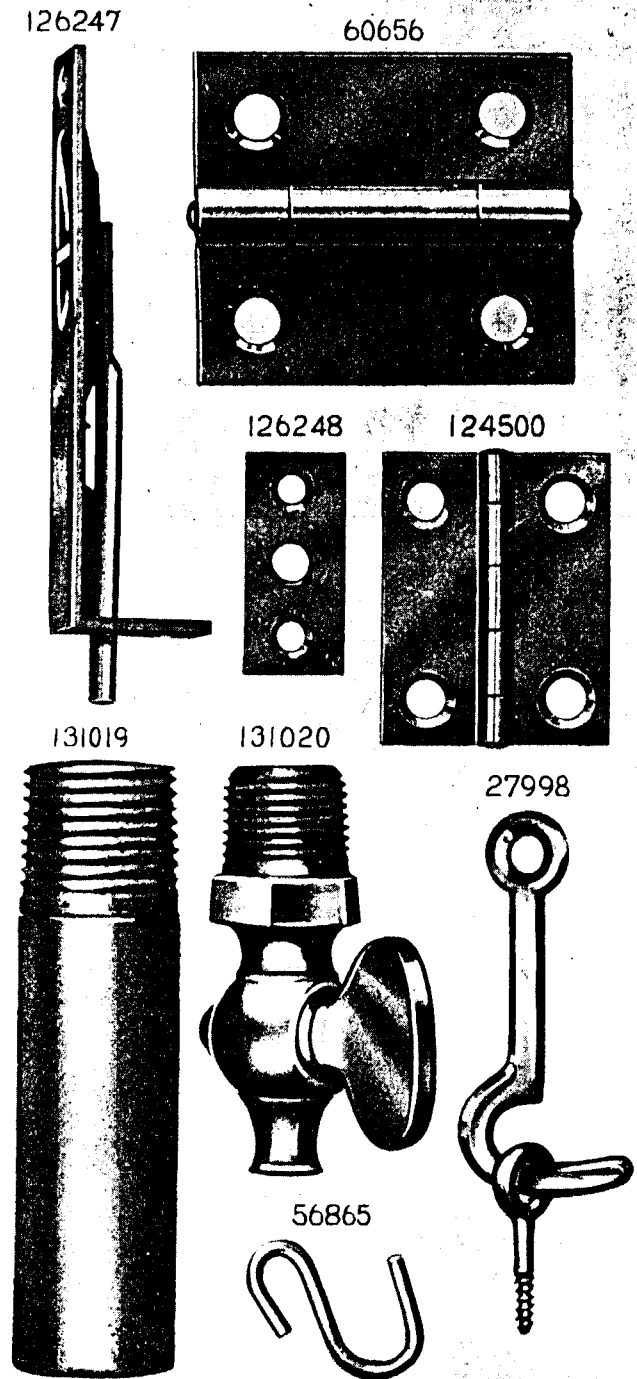
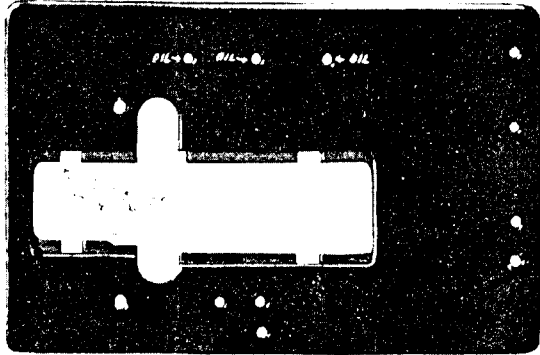


PLATE 20508—ONE-FOURTH SIZE

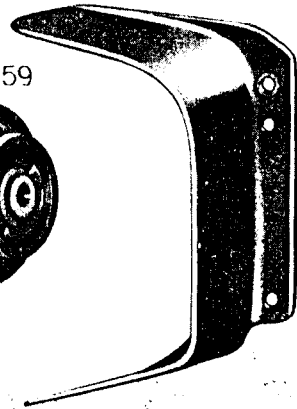
68449



68440 131104

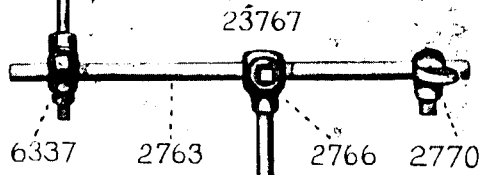


131130



64259

7125



23767

6337

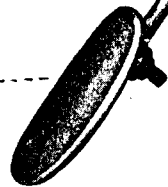
2763

2766

2770

6335

2767

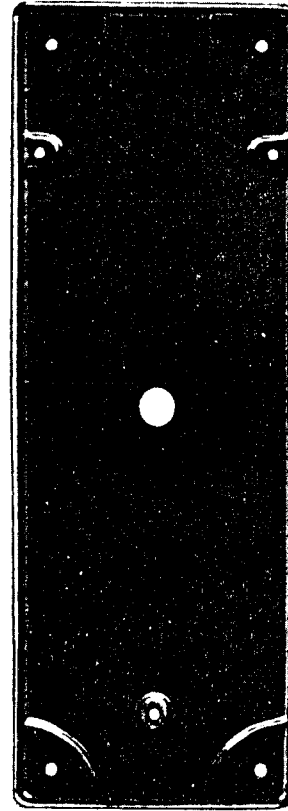


12242

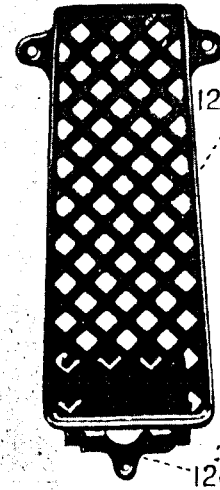


PLATE 20509—ONE-FOURTH SIZE

131018



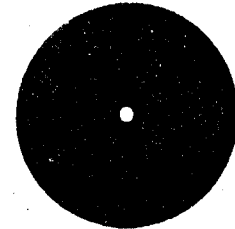
126252



126249

126251

150203



68222

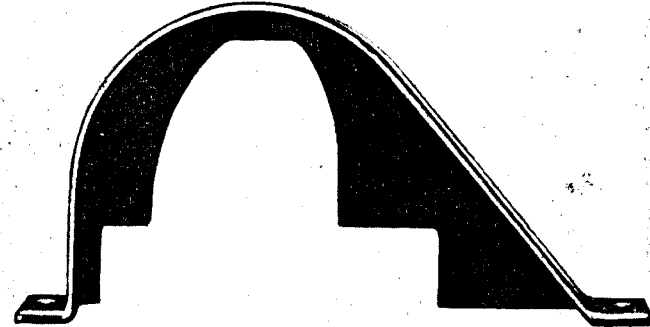


PLATE 20520—FULL SIZE

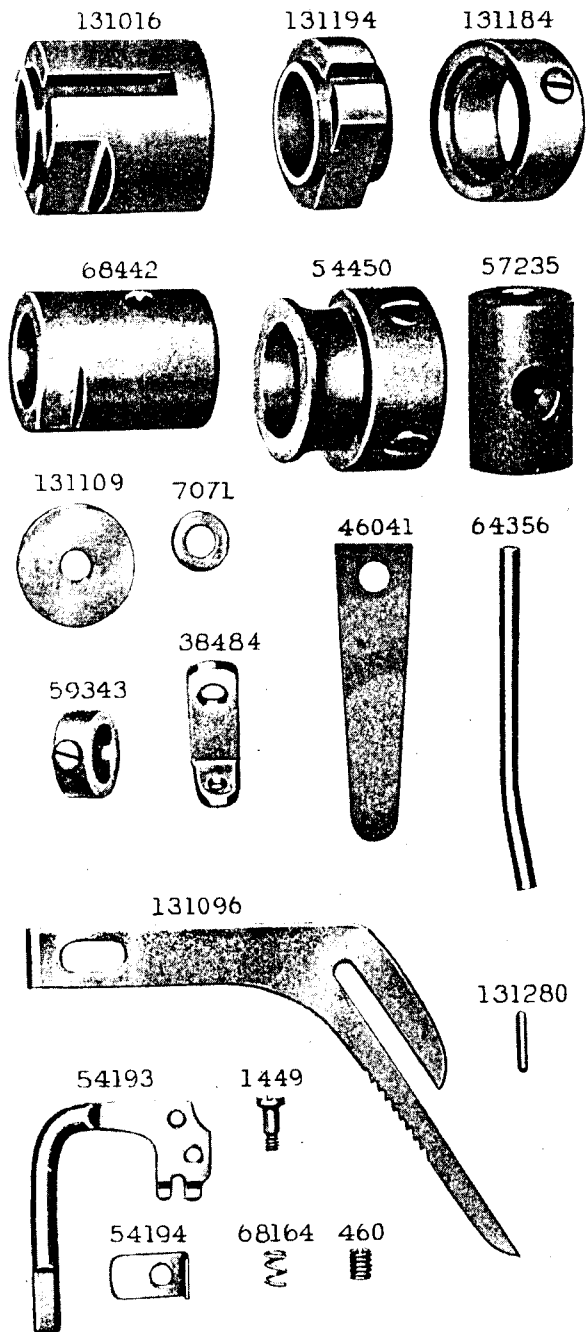


PLATE 20521—FULL SIZE

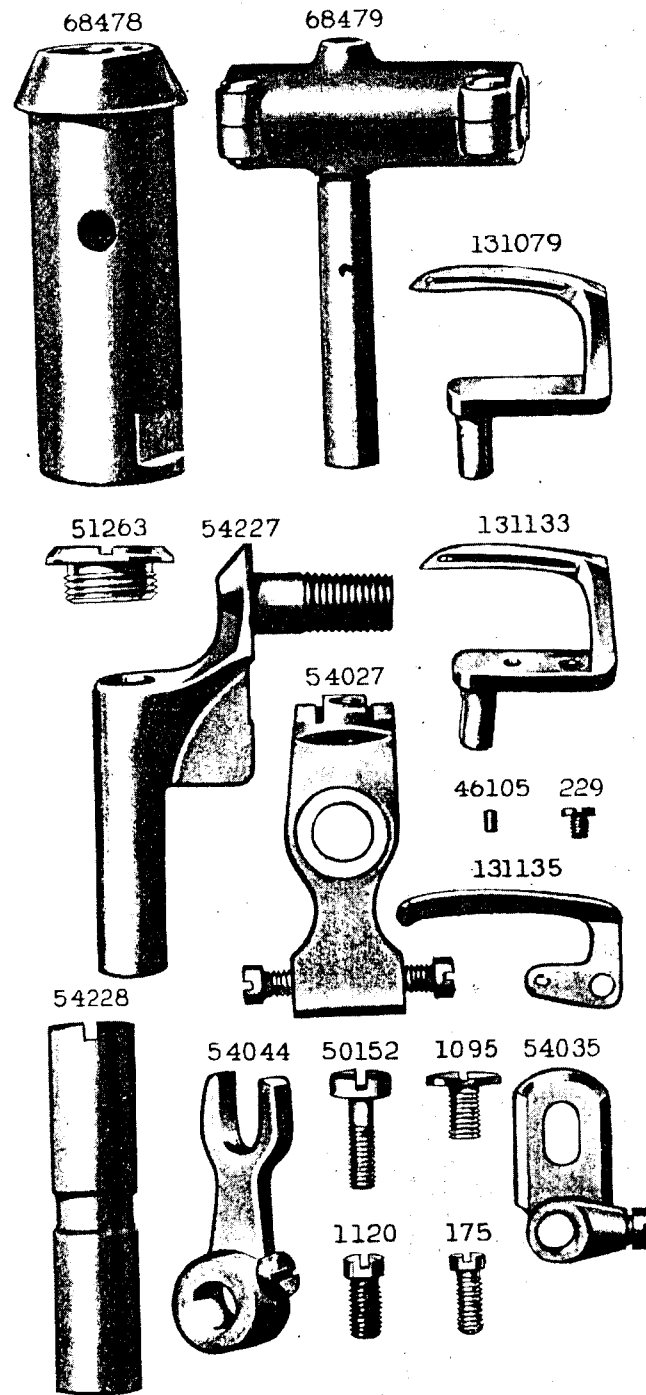


PLATE 20522—FULL SIZE

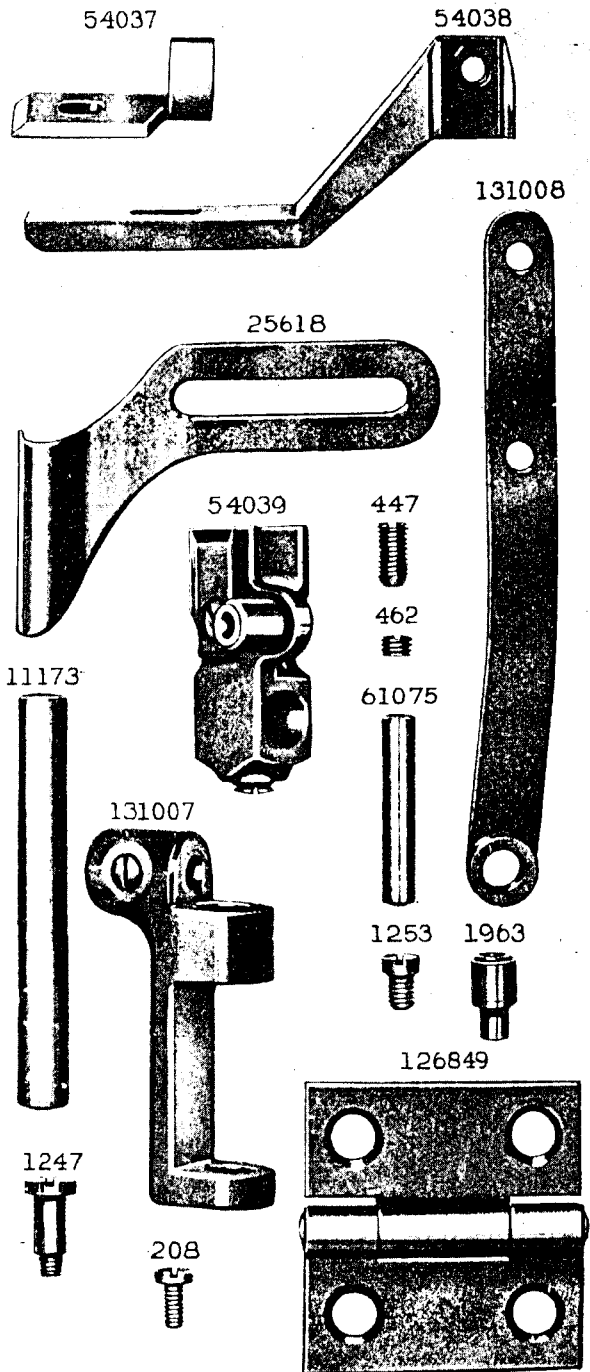


PLATE 20523—FULL SIZE

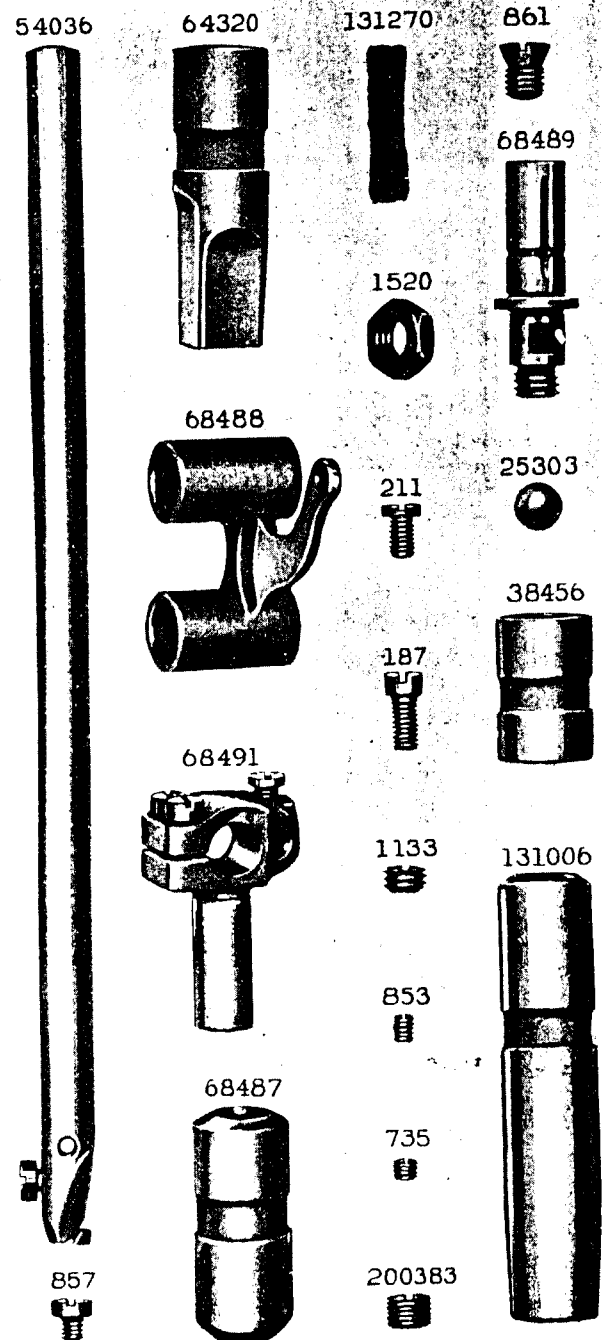


PLATE 20524—FULL SIZE

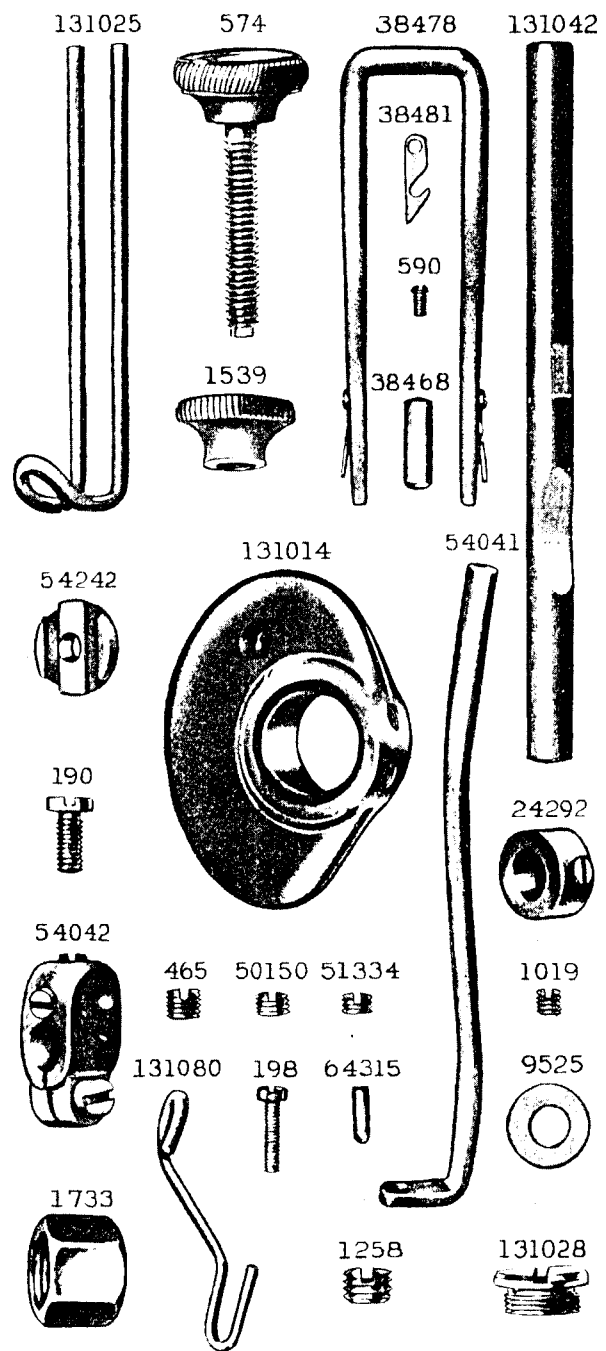


PLATE 20525—FULL SIZE

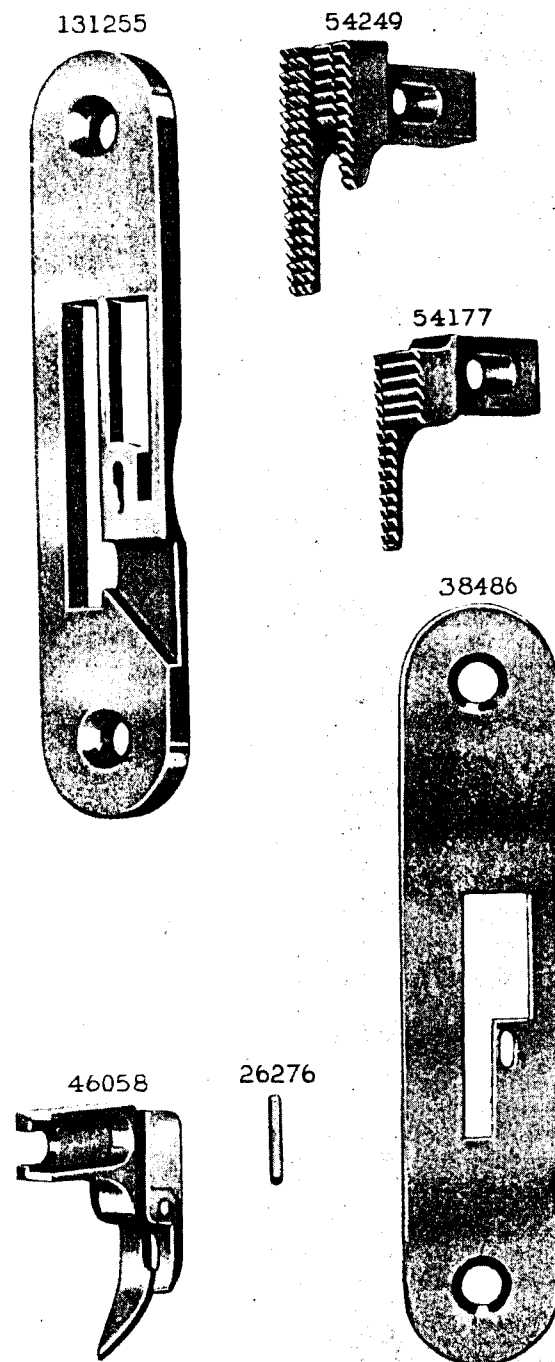


PLATE 20526—ONE-HALF SIZE

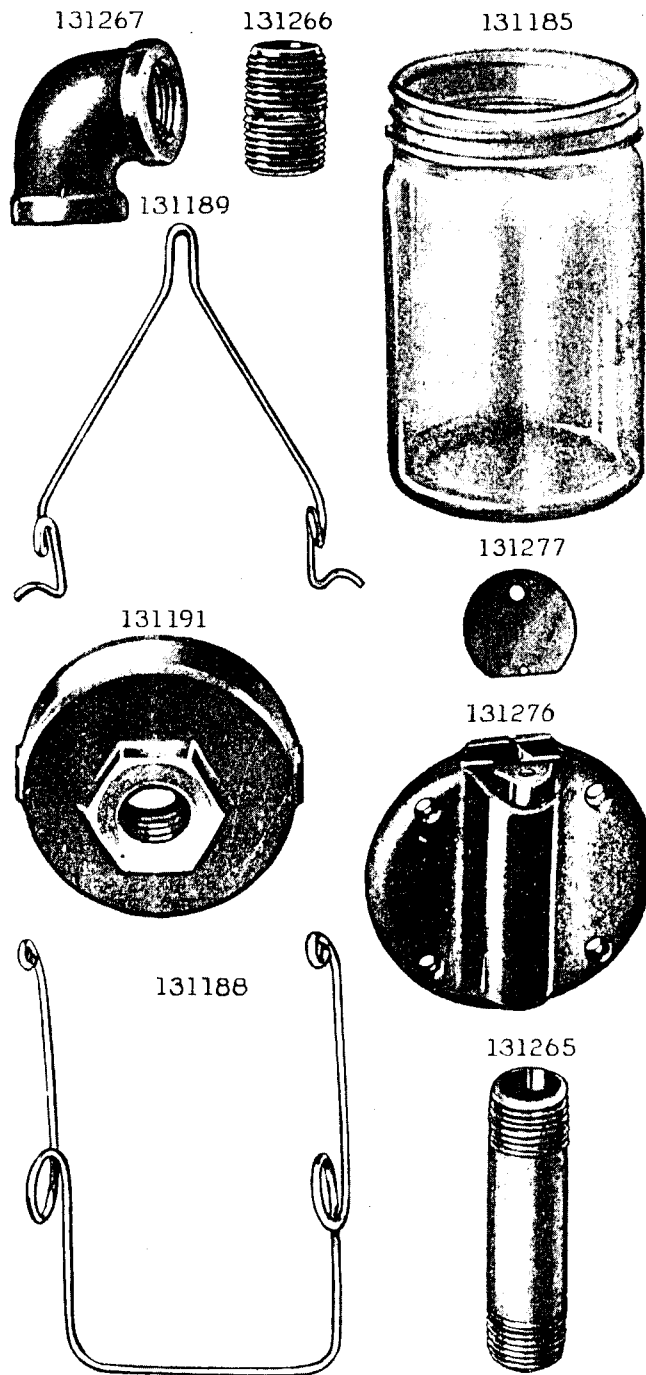


PLATE 20527—ONE-HALF SIZE

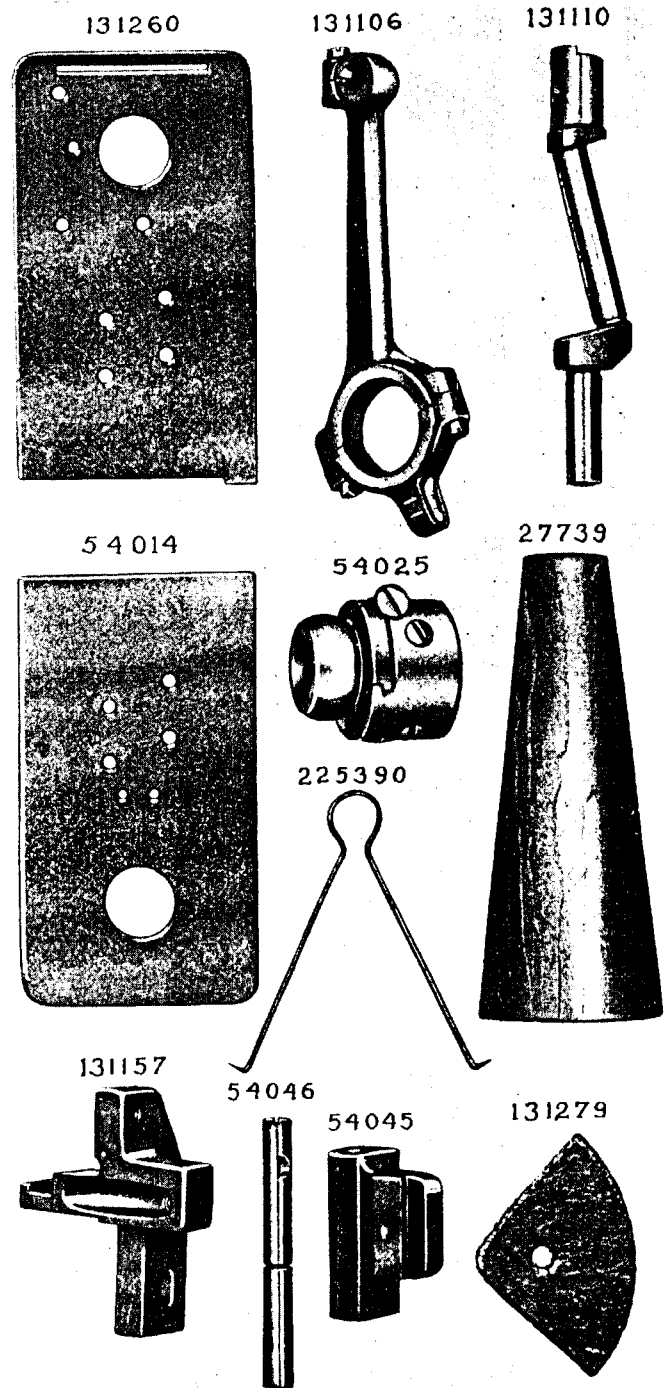


PLATE 20528—ONE-FOURTH SIZE

131263

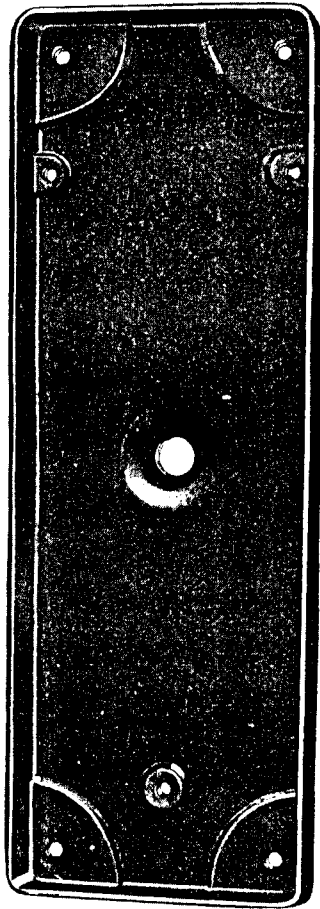


PLATE 20787—ONE-SIXTH SIZE

