

# DC-500

## User manual



## **CONTENT**

### **1. Advisory Note**

- 1.1 CD-ROM
- 1.2 Before using the DC-500
- 1.3 Copyright information
- 1.4 Caution when using the camera

### **2. Getting to know your DC-500**

- 2.1 Control Reference
- 2.2 Monitor screen display

### **3. Usage preparations**

- 3.1 Load batteries and memory card
- 3.2 Turn ON/OFF the camera
- 3.3 Set up

3.4 Playback function

3.5 Using your DC-500

**4. How to install and use the application**

4.1 Driver Installation

4.2 Software Installation

**5. Specifications**

**6. Q&A section**

**7. Addendum**

**8. Customer Care**

## **1. Advisory Note**

Thank you for purchasing this DC-500 digital camera. Please read these operating instructions carefully in order to use the product correctly. Keep the instructions in a safe place after reading so that you can refer to them later.

### **1.1 CD-ROM**

The software CD-ROM packaged with the camera is designed for PC only. To play this CD-ROM on a stereo or CD player may cause damage to it. This camera is a precision electronic device. Do not attempt to service this camera yourself, as opening or removing covers may expose you to dangerous voltage points or other risks. This will invalidate all guarantee claims. Do not expose this camera under direct sunlight to avoid causing a fire.

### **1.2 Before using the DC-500**

Try to take some pictures before you perform the formal recording. Before taking pictures with this camera of any important occasion (such as a

wedding ceremony or on vacation), do test the camera beforehand to ensure that it functions well. Any additional loss caused by the malfunction of this product (such as costs of photography or any loss of benefit generated by the photography) is not the responsibility of our company and no compensation will be given for it.

### **1.3 Copyright information**

Unless agreed by the right owner, all the pictures taken with this digital camera cannot be used in violation of copyright law. Any transfer of pictures or memory card with data must be conducted under the constraints of copyright law.

### **1.4 Caution when using the camera**

This product consists of intricate electrical parts, to ensure the camera photographs normally, do not drop or hit the camera when taking pictures.

- Avoid using or placing the camera in the following locations:
  1. Damp and dusty places
  2. Sealed vehicles or places exposed to direct sunlight or places subject to

extremely high temperatures or heat

3. Turbulent environment

4. Locations full of smoke, oil fumes or steam

5. In rain or snow environment

- Do not open the battery cover when the power is on
- If water has entered the camera, immediately turn the power off and remove the batteries

• How to maintain your camera:

1. If the lens, LCD monitor or viewfinder surface is dirty, please use a lens brush or soft cloth to wipe the surface clean instead of touching the lens with your fingers.

2. Do not use any solid object to hit the camera to avoid scratching the lens, LCD monitor or viewfinder surface.

3. Do not use any detergent or volatile solution, which will subject the camera case and paint to dissolving or distortion, use soft cloth only.

## 2. Getting to know your DC-500

### 2.1 Control Reference

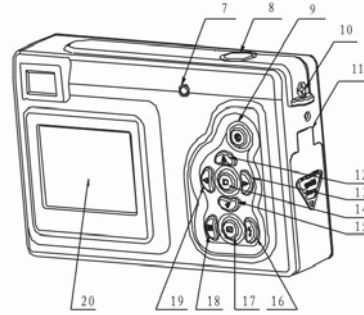
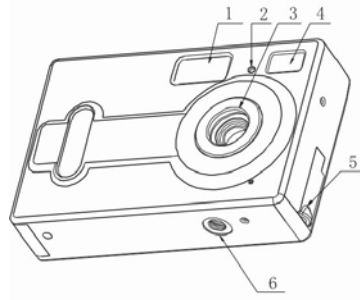

1. Flash light
2. Self-time LED
3. Lens
4. Viewfinder
5. USB jack
6. Tripod socket

7. Flash LED
8. Shutter button
9. ON/OFF button
10. Strap bar
11. Battery cover/card slot
12. Up button
13. RIGHT button
14. Menu button
15. Down button
16. Flash button
17. Playback button
18. Display button
19. Left button
20. Monitor screen

## 2.2 Monitor screen display

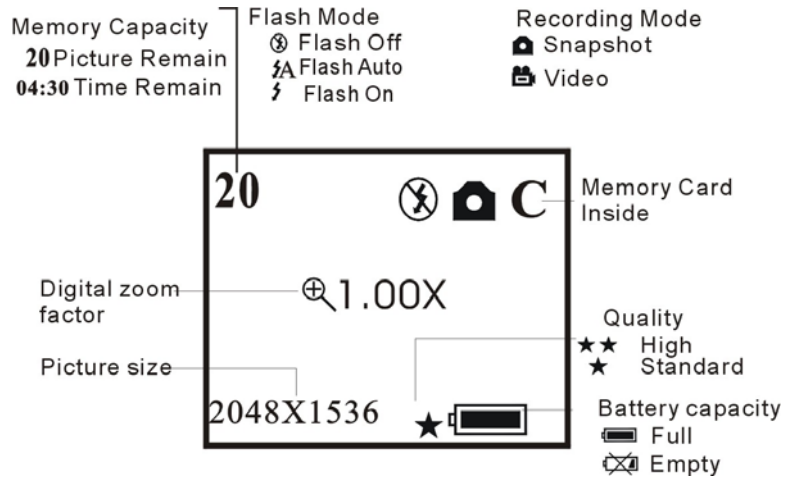



### **3. Usage preparations**

#### **3.1 Load batteries and memory card**

Open the battery cover and put in 3 AAA new alkaline batteries according to the polarity indicated on the battery door, then insert the memory card, close the cover. When the battery is in low voltage, a selected icon will appear on the screen, you need to select what kind of battery you are using, if you use alkaline battery, you should select 1, the battery capacity icon will display half, then you cannot use flash light, but you can still take photos until the icon displays empty; if you use rechargeable battery, you should select 2, the battery capacity icon still display full, you can take photos until the icon display empty.

#### **3.2 Turn ON/OFF the camera**

You start the camera when you press the ON/OFF button until the operation LED lights. Press the ON/OFF button for 2 seconds the camera will turn off. The camera will turn off automatically after 30 seconds of inactivity if not connected to USB. The auto power off time can be set in the menu of auto power off function.

### 3.3 Set up

#### Taking pictures and recording function

##### 3.3.1 Capture option

Press the menu button and enter the capture select window, press the UP or DOWN button to select the capture mode. Then press menu button to confirm your choice. Press RIGHT button to next menu.



##### 3.3.2 Color option

Press the menu button and enter the capture select window and press RIGHT button to next menu color. Press UP or DOWN button to select the item to adjust and menu button to enter the selected item.



Adjusting exposure value:  
EV range from -1.5 ~ 1.5

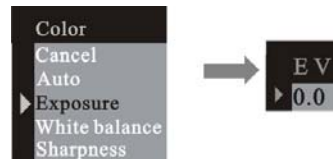

Selecting white balance option:



Adjusting sharpness option:



### 3.3.3 Resolution

Press the menu button and enter the capture select window and press RIGHT button to next menu resolution. Press the UP or DOWN button to select the resolution then press menu button to confirm:

High: 2592x1944  
Middle: 2048x1536  
Low: 1600x1200

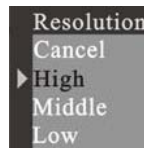

### 3.3.4 Quality

Press the UP or DOWN button to select the quality then press menu button to confirm. Press RIGHT button to next menu.



### 3.3.5 Auto power off time

Press the menu button and enter the capture select window and press RIGHT button to next menu Auto power off. Press the DOWN button to set your choice.

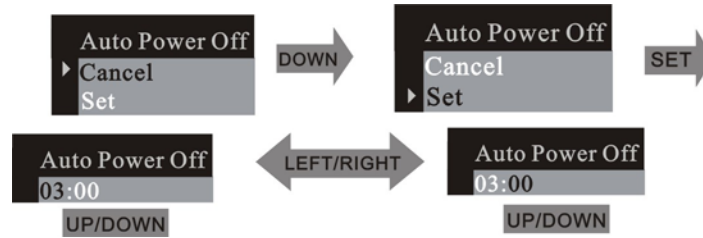

### 3.3.6 Date & Time

Press the DOWN button to set date and time.

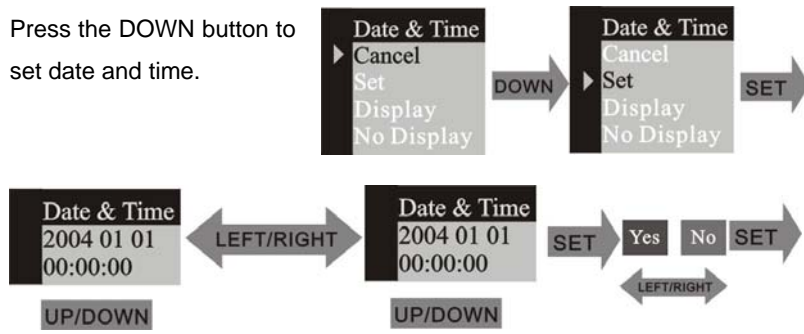

When you choose "DISPLAY", the date & time will show on the picture, otherwise choose "NO DISPLAY".

### 3.3.7 Frequency

In order to take a better indoor picture, the camera needs to be set to suit the correct lighting frequency. Set the frequency to 60Hz for US and 50Hz for Europe.

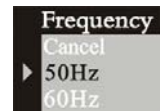

### 3.3.8 Language

Press the UP or DOWN button to select the language then press menu button to confirm your choice.



### 3.4 Playback function

Press the Playback button to select the playback mode

#### 3.4.1 Erase

Press the menu button to enter the erase window, press the UP or DOWN button to select "One" or "All". Press menu button to confirm your choice.

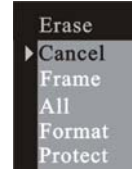

Select the format mode and format the memory card inside the camera.

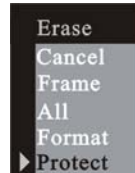

Select the protected mode and protect the frame selected.

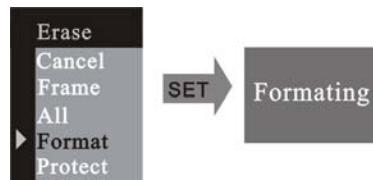

If you want to unprotect the frame, select the frame, then enter the erase mode; select unprotected mode. Press RIGHT button to enter the next menu.



### 3.4.2 Auto power off time

Press the DOWN button to set your choice.



### 3.4.3 Date & Time

Press the DOWN button to set your choice.

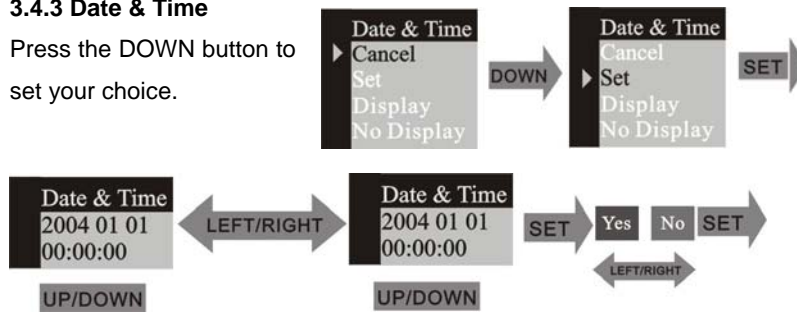

When you choose “DISPLAY”, the date & time will show on the picture, otherwise choose “NO DISPLAY”.

### 3.4.4 DPOF (Digital Print Order Format)

“DPOF” stands for “Digital Print Order Format”, which is a format for recording on a memory card or other medium which captured images and how many copies should be printed. Then you can print on a DPOF compatible printer or at a professional print service from the memory card



in accordance with the file name and number of copies settings recorded on the card.

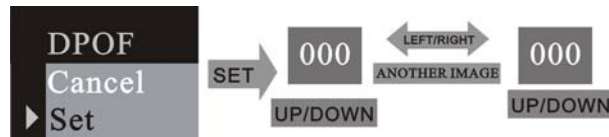

#### 3.4.5 Rotation

Press UP or DOWN button to select the rotation angle and menu button to enter the selected angle.

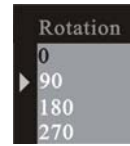

#### 3.4.6 Zoom/ PAN

In the single picture preview mode, the PAN function can be used to move the display range of the image after image has been enlarged in zoom mode. In the ZOOM / PAN menu, press the DOWN button to enter the PAN function and menu button to confirm the setting. Now press UP/ DOWN/ LEFT/ RIGHT button to move the display range of the picture. To cancel the PAN function,



press the menu and then DOWN button to exit.

### **3.5 Using your DC-500**

#### **3.5.1 Take pictures**

You just press the shutter button down and with a distinct beeping sound, a snapshot is finished. At the same time, the number on the monitor screen will decrease by one.

#### **3.5.2 Self-timer**

Press the menu button into the menu, change to the self-timer mode, after that press the menu button to confirm. Press the shutter button, the self-timer LED will blink for 10 seconds and then capture a picture.

#### **3.5.3 Take video**

Press the menu button into the menu and change to the video mode. Press the menu button to confirm your choice. Press the shutter button to start recording. Press the shutter button again to stop recording.

#### **3.5.4 Use the flash**

Press the flash button into the FLASH AUTO or ON mode, the camera will charge the flash; the monitor screen will be close and the operation LED will blink. When LED stops blinking and the monitor screen turns on, the charging is done. The FLASH ON function will always fire the flash, the FLASH AUTO function will fire automatically as needed. When the shutter button is pressed, the flash will fire.

#### **3.5.5 Use the digital zoom**

In the REC mode you can use the digital zoom. Before taking videos press the UP button to zoom in, press the DOWN button to zoom out.

#### **3.5.6 Playback mode**

Press the playback button to come to the playback mode. You can view up 9 pictures and video clip files on the LCD screen. Press the DISPLAY button and up to 9 files appear on the screen. In the one picture mode, press the UP or DOWN button and zoom in or zoom out of the picture. If a video is selected in the nine picture mode, press the DISPLAY button and

playback of the video starts.

### **3.5.7 Download**

Turn the camera on to the preview mode and connect the camera to the computer via a USB cable. In Windows 2000 / ME / XP, there is no need to install the driver. Connect the camera to PC. The LCD screen will display MSDC and the camera will be recognized as a removable FLASH DISK. You can directly copy the pictures from the camera to your computer. If you are running Windows 98SE, please install the camera driver first, then connect the camera to PC in preview mode, the computer will find a new device like USB mass storage device and install the device driver automatically, after the driver installed, the camera will be recognized as a removable FLASH DISK.

### **3.5.8 How to Use the PC camera function**

Install the camera driver from the CD. Connect the camera to the computer with a USB cable, run the program Amcap under the folder <Sunplus Ca533> in the program, select the device as Sunplus SPCA533.

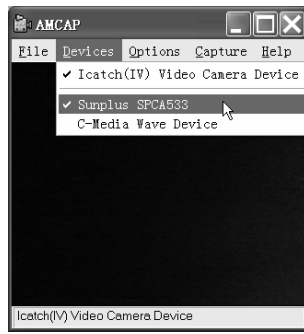

After that please select Options as Preview.

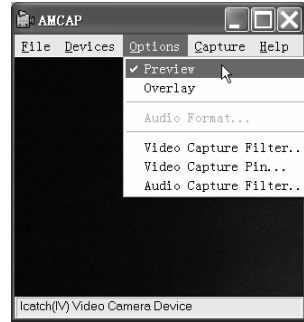

If you want to change the imaging size, select the Video Capture Pin then change the output Size.

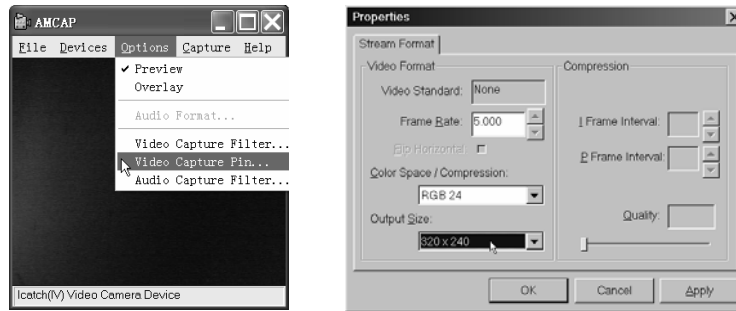

#### 4. How to install and use the Accompanying application

Insert the accompanying CD into the CD-ROM drive and the install dialogue box will appear automatically.



#### 4.1 Driver Installation

Click on the Camera Driver button and follow the next steps.







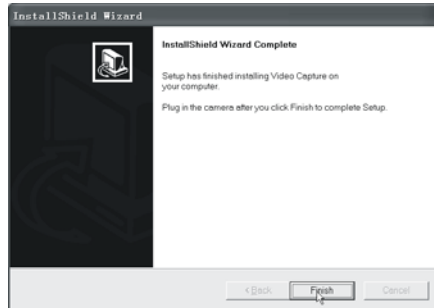

Set the camera to recording mode and connect it to the computer. The

computer will find a new device and automatically install the device driver. If the computer prompt needs a file path, search it with the path C:\WINDOWS\SETUP533. When the installation is finished, go to Control Panel \System \Hardware \Device Manager and check the Imaging Device \Icatch(IV) Still Camera Device and Icatch(IV) Video Camera Device are OK.

#### 4.2 Software Installation

Click on ArcSoft VideoImpression to install the Application software (ArcSoft VideoImpression).



Click on ArcSoft PhotoImpression to install the Application software (ArcSoft PhotoImpression).



Click on Adobe® Acrobat® Reader™ to install the software (Adobe® Acrobat® Reader™).



Click on User Guide (in PDF Format) to view the user guide.



Click on the "Exit" icon to close this screen and exit the setup program.



## 5. DC-500 specifications

\*3 in 1 mode:

- Digital still camera mode: image capture
- PC camera mode: video capturing / conferencing
- Camcorder mode: Video clips

Sensor: CMOS sensor, 5 megapixel

Lens: F=2.8 f=8.4

Focus range: 1.5M to infinity

Illumination: 100-16000 (lux)

Shutter speed: shutter 1/20-1/6000 s

Image resolution: high (2592 x 1944), medium (2048 x 1536), low (1600 x 1200) for image capture

VGA (640 x 480)/ QVGA (320 x 240) for PC camera mode

QVGA (320 x 240)/ QCIF (192 x 144) for Video recording mode

Memory: Internal memory 16 MB image memory, external SD and MMC card compatible (1 GB)

Self-timer: 10 secs

Zoom: 8x digital zoom

Colour LCD screen: 1.5 inch display  
OSD language: English, French, German, Spanish, Italian, Dutch, Turkish  
Portuguese  
Flash mode: On/Auto/Off  
Battery: 3AAA (alkaline/ 1.5V) batteries  
Interface: USB 1.1

PC Demand Specification

CPU: Pentium III 800MHz and upper  
OS: Windows 98SE/2000/ME/XP  
Memory: 256MB and upper memory  
Disk space: At least 250MB space free  
CD-ROM drive

Technical details can be changed without notice.

## **6. Common problems**

### **6.1 Camera will not turn on**

1. Battery is not properly installed: Remove and reinstall the batteries.
2. Insufficient battery voltage: Do not use old batteries or batteries with mixed battery life. It is not recommended to use rechargeable batteries with lower voltage.

### **6.2 Flash will not fire**

1. The flash is set to OFF: Set the flash to Auto or on.
2. Flash has not been fully charged the flash takes a few seconds to charge up while the operation LED is blinking. Flash light is fully charged when the operation LED turns off.
3. Battery level is low: When the battery indicator does not show a fully charged battery, the voltage is low for the flash to work. Please change new batteries.

### **6.3 Image is blurred / out of focus**

1. Subject is out of focal range. Ensure that there is at least 1.5 m ( 5ft )

between the camera lens and subject.

2. Camera moved: Hold the camera steady while taking the picture. When flash is on, hold the camera steady until flashes have fired two times. (First flash is to reduce a red-eye phenomenon and to detect the brightness of the target).

#### **6.4 Subject in recorded image is too dark**

Insufficient light for shooting: Set the flash on, or adjust the exposure compensation to a positive (+) setting.

#### **6.5 Flickering on LCD screen or recorded image**

Incorrect frequency setting: Check the correct anti-flicker frequency (50Hz or 60Hz) under fluorescent light setting.

#### **6.6 Picture download problem**

1. Computer does not recognize camera for Windows 98SE, camera driver has to be installed first before picture downloading. In picture preview mode, ensure that USB mode is set to MSCD before connecting the



camera to the computer. For Windows 2000/ ME /XP, the camera is recognized as a plug&play, removable flash disk without driver installation under MSDC mode.

**It is always recommended to disconnect your digital camera from your computer by the safety unplug button on your desktop to ensure that the USB port is released for next-time interface.**

2. Flash disk does not display images recorded. The camera will load two removable flash drives on your computer under MSDC mode. The first drive is the external SD or MMC cartridge and the second drive is the recorded images saved in the built-in memory of the camera. In cases when the removable flash drive names coincide with those already assigned by the computer in the network, you need to reassign the name for the removable flash disks:

Right click <My Computer> → Manage Disk Management → Right click blue bar of removable disk which is on line → Change Drive Letter & Paths Change → Assign the Following Drive Letter (assign an unused drive name)

→ OK. Open the new renamed removable flash drive to download recorded pictures.

## **7. Addendum**

### **7.1 Disclaimer**

We assume no responsibility over and above the provisions of the Product Liability Law for damages suffered by the user or third parties as a result of inappropriate handling of the product or its accessories, or by their operational failure and by their use. We reserve the right to make changes to this product and its accessories without prior notice.

**Warning!** Never try to open the camera or to take it apart. This will invalidate all guarantee claims.

### **7.2 Using your batteries**

For best performance and prolonged battery life, we recommend the use of AAA alkaline or rechargeable Ni-MH batteries.

### **7.3 Extending battery life**

The following functions use up a great deal of battery power and should therefore only be used occasionally:

- Excessive use of flash
- Editing images on the camera display

The battery life can be affected by soiling. Please clean the contacts with a clean and dry cloth before putting the batteries in the camera.

Battery performance drops at temperatures below 5 °C (41 °F). If you use the camera at low temperatures you should have replacement batteries to hand and ensure they do not get too cold. Please note: you should not dispose of cold and seemingly flat batteries because these batteries may work again at room temperature.

#### **7.4 Disposal of Waste Equipment by Users in Private Households in the European Union**



This symbol on the product or on its packaging indicates that this product must not be disposed of with your other household waste. Instead, it is your responsibility to dispose of your waste equipment by handing it over to a designated collection point for the recycling of waste electrical and electronic equipment. The separate collection and recycling of your waste equipment at the time of disposal will help to conserve natural resources and ensure that it is recycled in a manner that protects human health and the environment. For more information about where you can drop off your waste equipment for recycling, please contact your local city office, your household waste disposal service or the shop where you purchased the product.

### **7.5 Declaration of Conformity**

We herewith confirm the following designated product: DC-500 has been tested and found to comply with the requirements set up in the council directive on the approximation of the law of member states relating to the EMC Directive 89/336/EEC, amended by 92/31/EEC & 93/68/EEC. For the evaluation regarding to the electromagnetic compatibility, the following standards were applied

EN 55022: 1998 + A1 : 2000 + A2: 2003

EN 55024: 1998 + A1: 2001 + A2: 2003

EN 61000-3-2: 2000

EN 61000-3-3: 1995 + A1: 2001

The device is marked with CE Logo.

### **7.6 FCC Compliance and Advisory**

This device complies with Part 15 of the FCC Rules. Operation is subject to the following two conditions: 1.) this device may not cause harmful interference, and 2.) this device must accept any interference received,

including interference that may cause unsatisfactory operation.

This equipment has been tested and found to comply with the limits for a Class B peripheral, pursuant to Part 15 of the FCC Rules. These limits are designed to provide reasonable protection against harmful interference in a residential installation. This equipment generates, uses, and can radiate radio frequency energy and, if not installed and used in accordance with the instructions, may cause harmful interference to radio communication. However, there is no guarantee that interference will not occur in a particular installation. If this equipment does cause harmful interference to radio or television reception, which can be determined by turning the equipment off and on, the user is encouraged to try to correct the interference by one or more of the following measures.

- Reorient or relocate the receiving antenna.
- Increase the separation between the equipment and receiver.
- Connect the equipment to an outlet on a circuit different from that to which the receiver is connected.
- Consult the dealer or an experienced radio/TV technician for help.

Any changes or modifications not expressly approved by the party responsible for compliance could void the user's authority to operate the equipment. When shielded interface cables have been provided with the product or when specified additional components or accessories have elsewhere been designated to be used with the installation of the product, they must be used in order to ensure compliance with FCC regulations.

## **8. Customer care**

More information to the complete product range can be found under:  
[www.plawa.com](http://www.plawa.com)

Service & Repair Hotline (EU):  
00800 75292100 (from landline only)

Service & Support Hotline (D):  
0900 1000 042 (1,49 Euro/min. from a German landline only)

Online Service:  
[support-apdc@plawa.com](mailto:support-apdc@plawa.com) (German / English)

Manufactured by  
plawa-feinwerktechnik GmbH & Co. KG  
Bleichereistr. 18  
73066 Uhingen  
Germany



AGFAPHOTO is used under license of Agfa-Gevaert NV & Co. KG. Agfa-Gevaert NV & Co. KG does not manufacture this product or provide any product warranty or support. For service, support and warranty information, contact the distributor or manufacturer. AgfaPhoto, AGFAPHOTO and product names are registered trademarks of their respective owners. Product design and appearance are subject to change without notice.

AgfaPhoto Holding GmbH, [www.agfaphoto.com](http://www.agfaphoto.com)

Manufactured and distributed by plawa-Feinwerktechnik GmbH & Co. KG, [www.plawa.com](http://www.plawa.com)