

Health o meter[®]
P r o f e s s i o n a l

Model 402LB Physician Beam Scale



User Instructions

Thank you for your purchase of this Health o meter® Professional product. Please read this manual carefully, and keep it for easy reference or training.

TABLE OF CONTENTS

Caution and Warning.....	3
Specifications for This Scale	3
Certifications / Disposal / Service	4
Assembly Instructions 402LB Scale	5
Transportation	10
Operating Instructions	13
Height Measurement Instructions.....	16
Troubleshooting	18
Maintenance.....	19
Warranty.....	20

Note: This scale has been factory calibrated, and does not require calibration prior to use.

Please register your scale for warranty coverage at:

<http://www.homscales.com/customer/registration.aspx>

For User Instructions updates and revisions please go to:

<http://www.homscales.com>

CAUTION AND WARNING

- To prevent injury and damage to your scale, please follow these instructions very carefully.
- To prevent injury, as well as scale damage during assembly, exercise caution when assembling the scale pillar.
- Assemble and operate the scale per the enclosed user instructions.
- For accurate weighing, this scale must be placed on a flat, stable surface.
- For accurate weighing, verify before each use the proper operation according to the procedure described in this manual.
- Do not transport the scale with any weight on the platform.
- Do not exceed recommended weight limit of 400 lb for this scale.
- Do not use in the presence of flammable or explosive materials.
- If the scale becomes damaged, it should not be operated until properly serviced. All repairs should only be performed by authorized Health o meter® Professional service personnel.
- To prevent patient injury, the patient must be attended throughout the entire weighing event.

SPECIFICATIONS FOR THIS SCALE

General

The Model 402LB physician beam scale employs a proven and rugged mechanical design to measure patient weight and height. Each precision scale is designed to provide accurate, reliable, and repeatable weight measurements. In addition, each scale is designed to provide the user with features that make the weighing process simple, fast, and convenient.

Weight is displayed in pounds (lb). Height is displayed in inches (in) or in centimeters (cm).

402LB Scale Specifications

Capacity:	400 lb	
Environmental:	Operating temperatures: 50°F to 104°F (10°C to 40°C) Storage temperatures: 50°F to 104°F (10°C to 40°C) Maximum Humidity: 85% RH	
Physical Dimensions:	Scale (Overall Dimensions) Width: 16-¾" (42.6 cm) Depth: 20" (50.8 cm) Height: 57-½" (146.1 cm) Weight: 43 lb (19.5 kg)	Platform (Standing Area) Width: 10-½" (26.7cm) Depth: 14" (35.6 cm) Height: 3" (7.6 cm)

CERTIFICATIONS / DISPOSAL / SERVICE

Certification Descriptions

	<p>Pelstar, LLC has been officially certified as the manufacturer of Health o meter® Professional medical devices. The Pelstar, LLC quality assurance system covers the development, production, sales and service of medical scales and measuring systems.</p>
---	---

402LB Scale Disposal



This Health o meter® Professional scale must be disposed of properly as steel waste. Follow the national, regional or local regulations which apply to you for disposal of steel waste.

CUSTOMER SERVICE INFORMATION

The 402LB physician beam scale is shipped disassembled in one carton. Carefully inspect the carton for shipping damage before unpacking. If damage is found, contact Customer Service.

For further information or telephone support, please contact Customer Service at:

Telephone: 1 (800) 815-6615

Email: HomProCS@homscales.com

402LB ASSEMBLY INSTRUCTIONS

Before Assembly

Each 402LB physician beam scale is shipped disassembled in one carton. Carefully inspect the carton for shipping damage before unpacking. If damage is found, contact your shipper or a Health o meter® Professional representative immediately. Claims must be filed with the shipper as soon as possible after receipt of the package. The following information details what you will find inside the main carton as you unpack the parts for assembly.

To prevent scratching any components and avoid damaging the scale parts when unpacking, do not use a box cutter, knife, scissors, or any sharp object to open the protective inner packaging. Carefully remove each assembly from the carton and unwrap the packing materials. Set the carton aside for storage.

Parts List

Carton

- (1) Scale platform
- (1) Pillar
- (4) Pillar nuts
- (1) User instructions
- (1) Wrench

Tools Required

Wrench (included)

402LB ASSEMBLY INSTRUCTIONS (CONTINUED)

Assembling the 402LB Scale (Refer to Figures 1 - 6)

Caution: It is recommended that the assembly be performed by two persons.

1. Carefully remove the scale platform and pillar from the carton. Place the scale platform and pillar on a flat, level, and dry surface. Using a table can be helpful for assembly of 402LB scale (see Figures 1 & 5).
2. Remove the four pillar nuts and wrench from the carton.
3. Locate the steel rod at the base of the pillar (see Figures 4, 5 & 6).
4. Cut the tie wrap that holds the steel rod to the pillar studs (see Figure 3).
5. Insert studs into the four holes provided in the scale platform (See Figure 2).
6. Tip the scale platform at an angle, resting the top of the pillar on any convenient support. Using the wrench provided, secure the pillar to the scale platform with the four nuts (see Figures 4 & 5).
7. Pull the steel rod toward the base of the scale platform by grasping the finger pull loop on the steel rod end (see Figures 4, 5 & 6).
8. Push the lever extension toward the pillar with your hand (see Figure 4, 5 & 6).
9. While holding this position, hook the steel rod to the hole at the end of the lever extension. Release the finger pull loop and ensure that the steel rod and lever extension is hooked together.
10. Carefully position the scale to its upright position.
11. The scale is now assembled and is ready for use (see Figure 1).

Note: To transport your scale, acquire the optional wheel bracket (Part Number # 55000). Please refer to the "Transportation" section for assembly instruction.

402LB ASSEMBLY INSTRUCTIONS (CONTINUED)



Figure 1

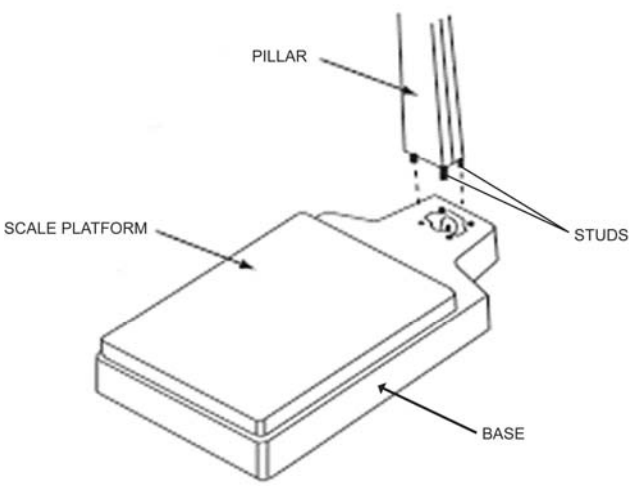

Figure 2

402LB ASSEMBLY INSTRUCTIONS (CONTINUED)

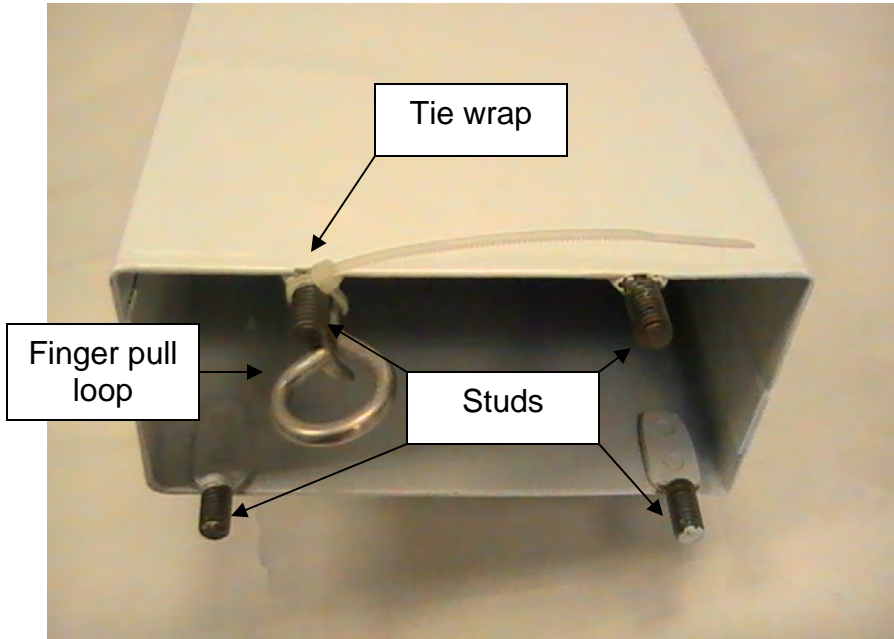

Figure 3

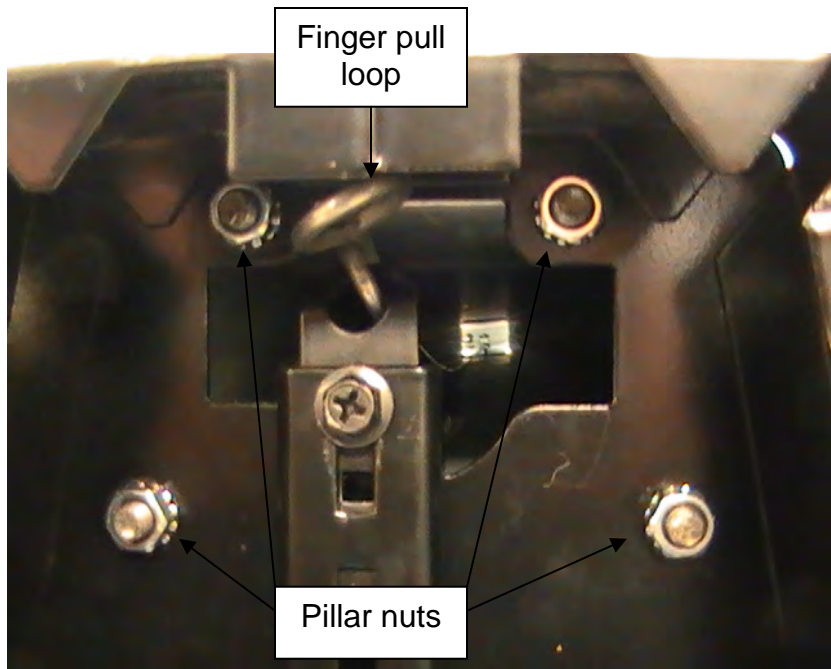

Figure 4

402LB ASSEMBLY INSTRUCTIONS (CONTINUED)

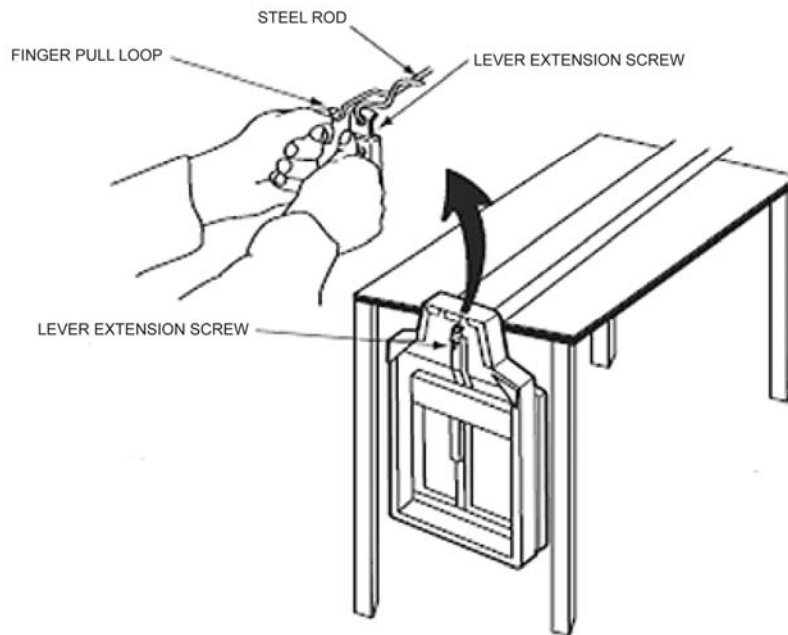

Figure 5

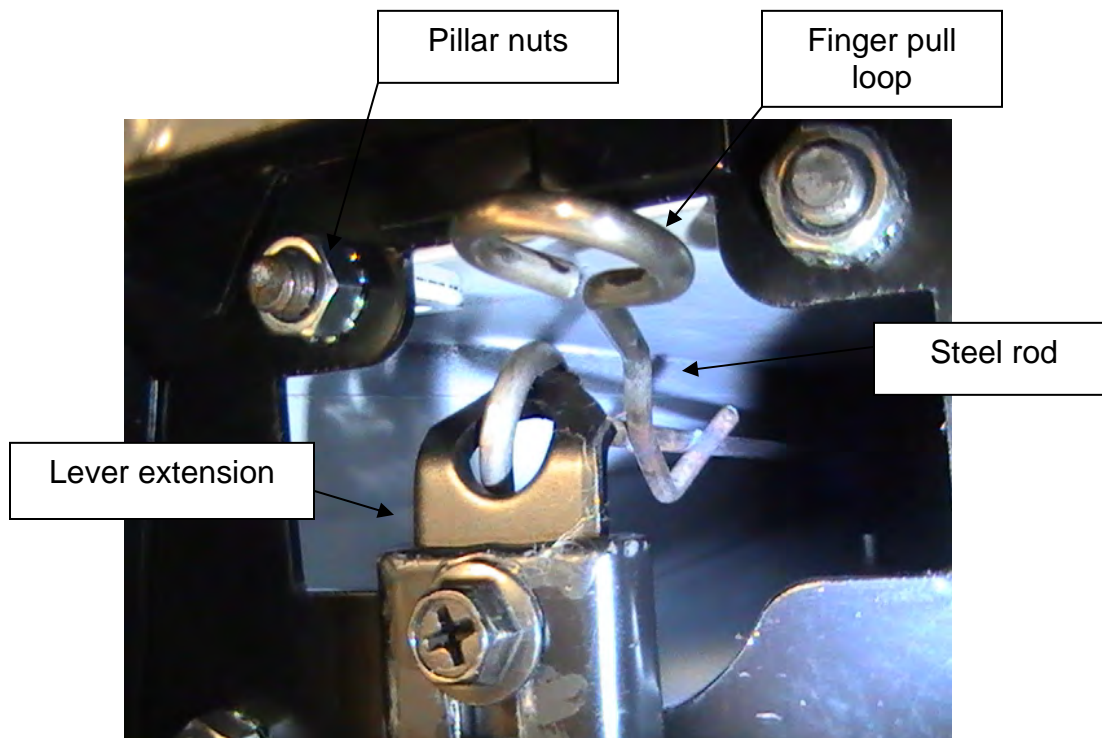

Figure 6

TRANSPORTATION

Preparing a 402LB Scale for Transportation (see Figures 7-10)

This scale can be easily assembled with a wheel bracket (Part Number 55000) for storage, or for transport from one room to another. This scale does not include 55000 wheel bracket, and must be acquired separately. To prepare the scale for transport, follow these steps:

Caution: It is recommended that the assembly be performed by two persons.

1. Remove the mounting screws attaching the clamping plate to the wheel bracket.
2. Tip the scale forward until top front of the pillar is resting on the floor.
3. Position the clamping plate inside the base, and align the clamping plate, wheel bracket, and base assembly holes.
4. Install the mounting screws through the wheel bracket, base, and clamping plate. Tighten the mounting screws securely.
5. Carefully tip the scale to its upright position.
6. To transport the scale, tip the scale pillar back until the scale is supported by the wheel bracket. Carefully move the scale to its new location.

Required Parts

- (1) 402LB
- (1) Wheel Bracket (Part Number 55000)

Note: Wheel Bracket is not included.

Tools Required (not included)

Adjustable wrench or 10mm wrench

TRANSPORTATION (CONTINUED)

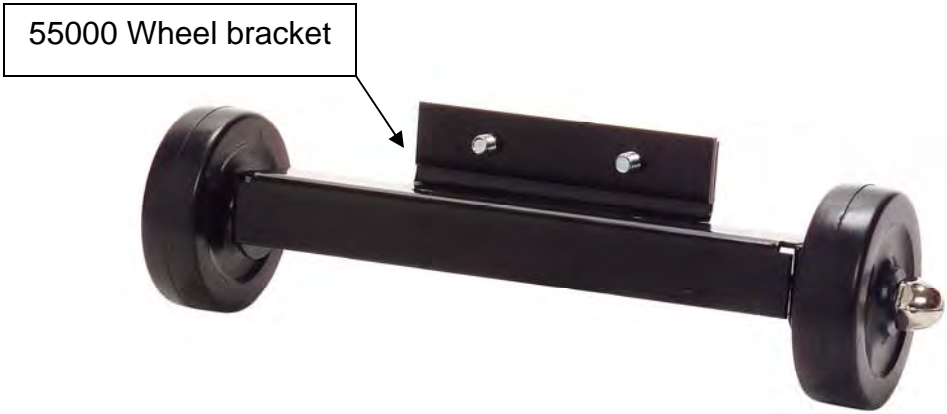

Figure 7

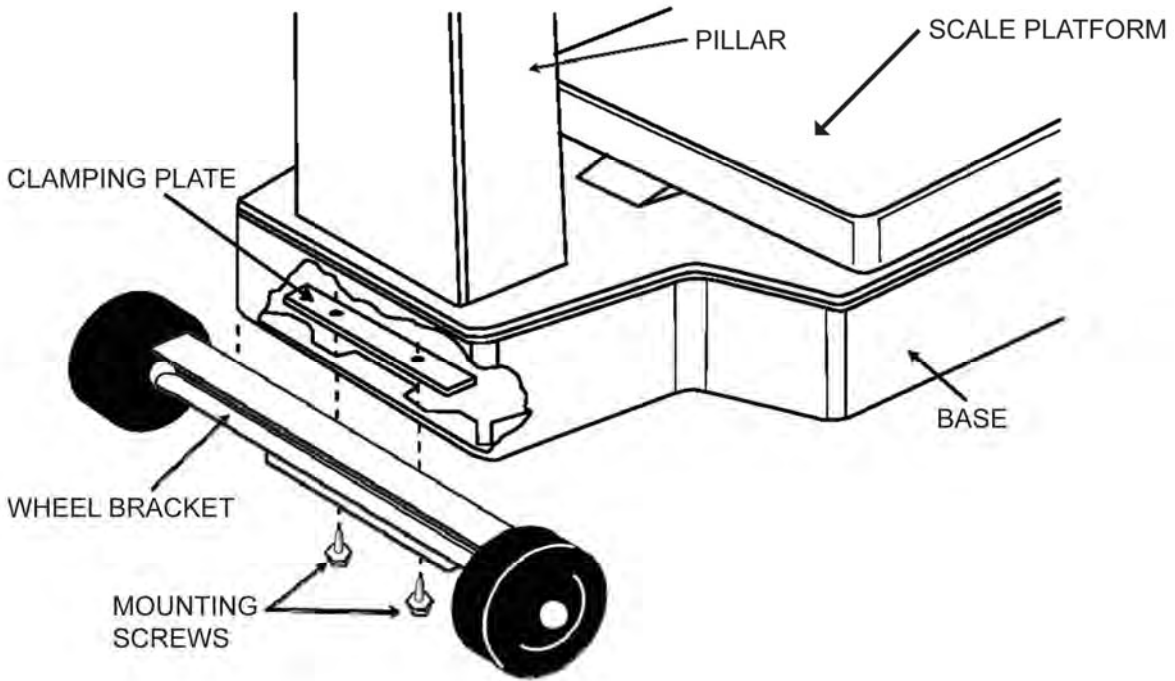

Figure 8

TRANSPORTATION (CONTINUED)



Figure 9

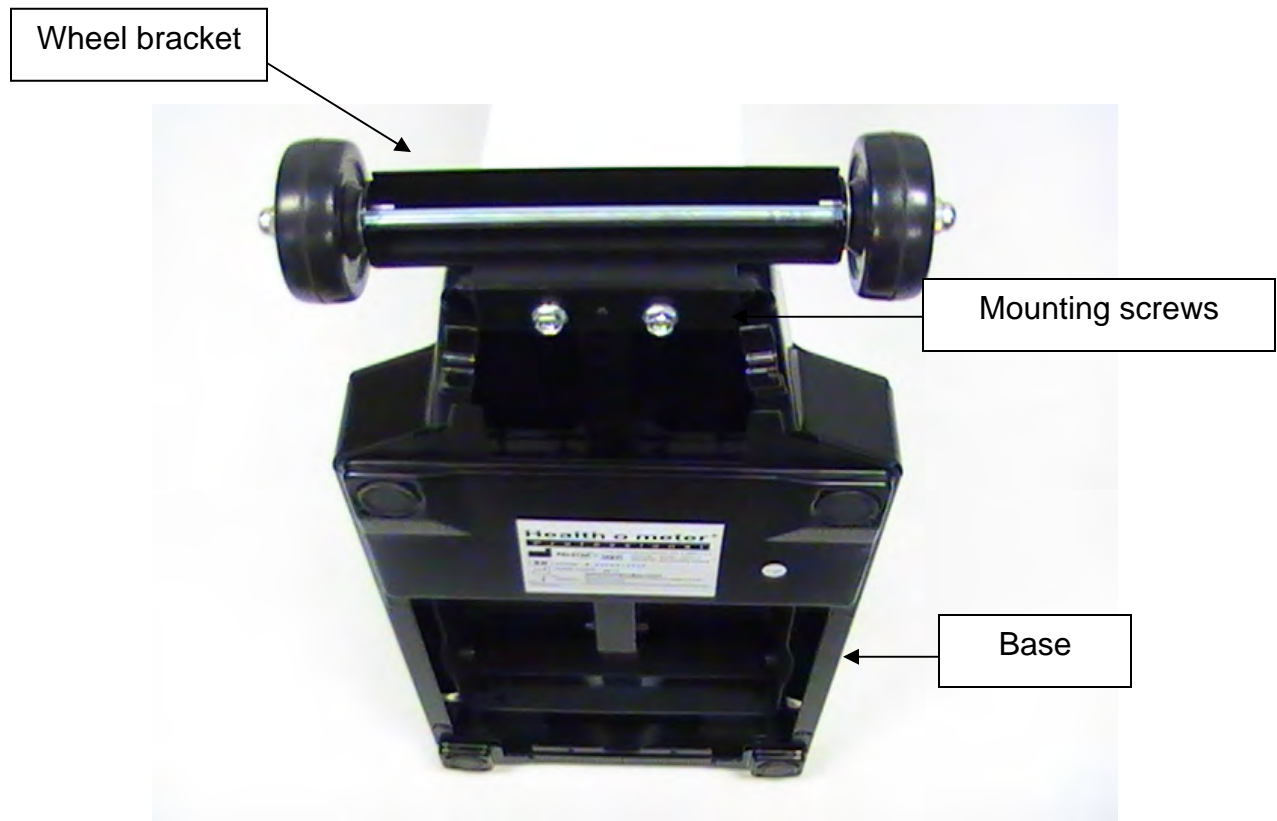

Figure 10

OPERATING INSTRUCTIONS

Zero Balance Adjustment (see Figures 11 - 13)

The scale should be checked periodically, particularly when moved, by following the instructions below:

Note: A flat head screwdriver is required.

1. Ensure that the scale is located on a hard, flat, and level surface. Step on and off scale several times in order to align all internal parts.
2. Place both poise weights on the "0" value on both bars. The beam pointer should float gently up and down, and not touch the top or bottom of the trig-loop.
3. If the beam pointer is not centered in the trig-loop opening, rotate balance ball screw to correct the beam pointer.

Weighing Instructions

1. Set the large and small poises to indicate your approximate weight.
2. Step onto the scale. Continue to adjust the small and large poise weights until the pointer is centered.

Note: It is not necessary for you to wait for the pointer to stop moving in order to read your correct weight. As long as the pointer is moving equally within the trig-loop opening, the patient's weight can be determined.

3. The patient weight can be recorded in pounds.
4. Observe the location of the indicator arrow built into each poise weight. Read the value on the poise bar, closest to the indicator arrow.
5. For easy identification, pounds (lb) have black graduations on a silver background, located on the poise bars.
6. Add the indicated reading of the small poise value to the indicated reading of the large poise value. The total amount is your weight.

Weighing Hints

1. Weigh yourself at approximately the same time each day. The foods you eat, the liquids you drink, and your level of activity will cause your weight to vary during the day.
2. For accurate measurements, weigh yourself without clothing. The average weight of clothing, including shoes, is about 2 - 5 lb for women and 5 - 8 lb for men.

OPERATING INSTRUCTIONS (CONT)

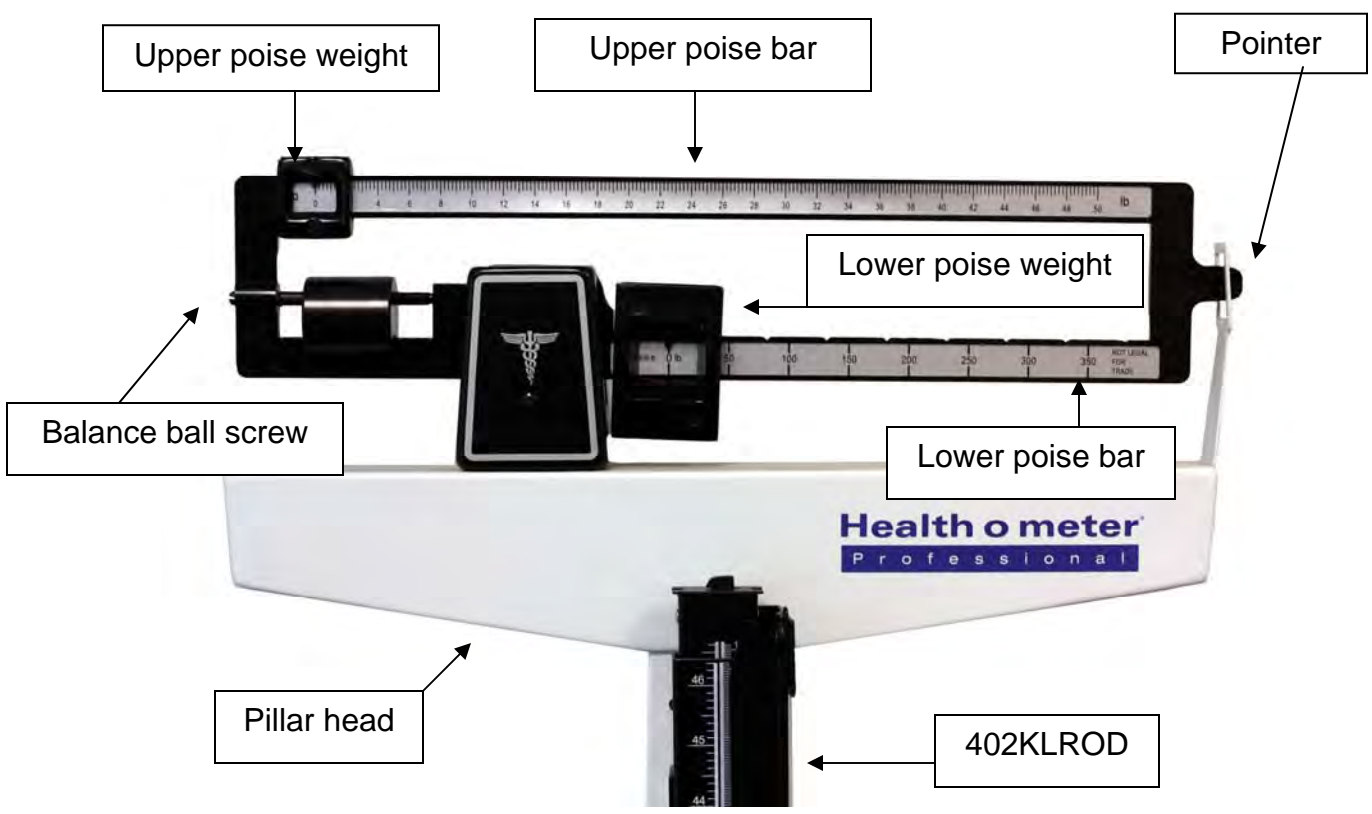

Figure 11

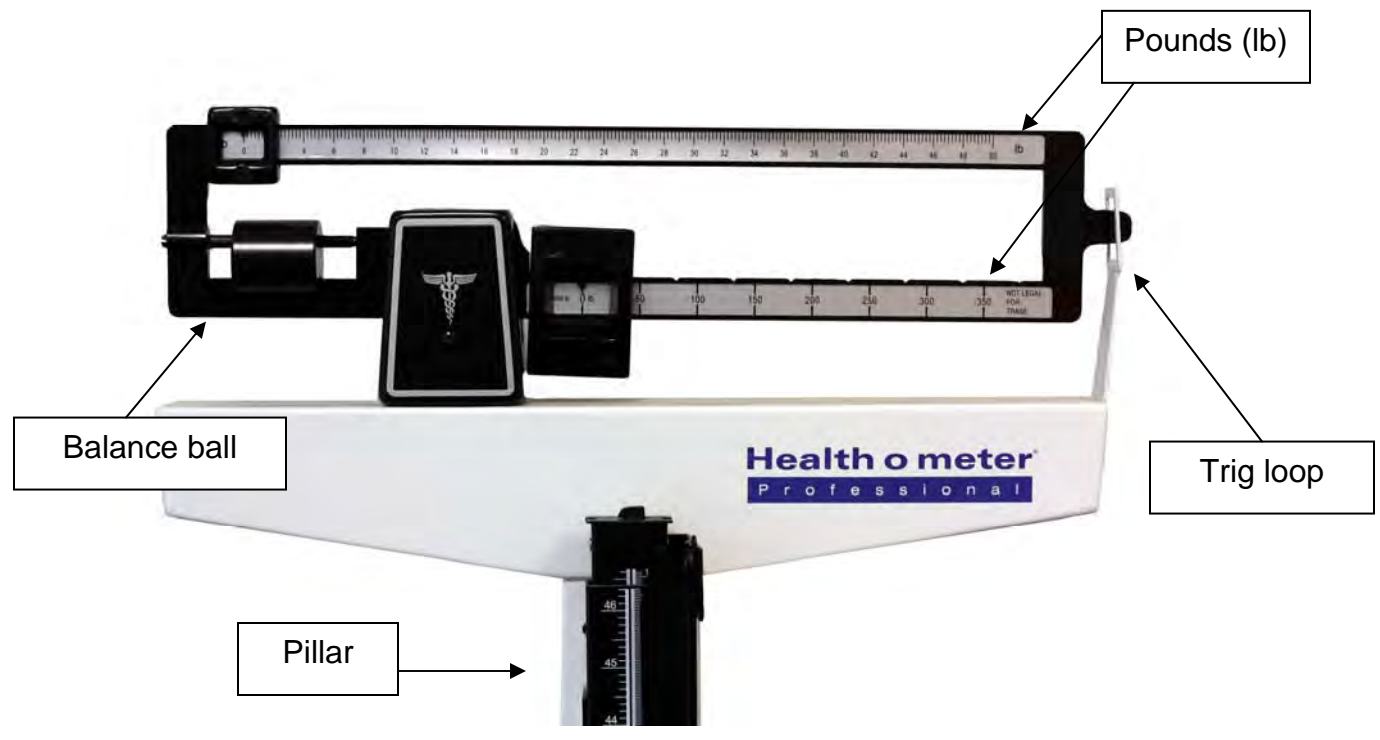

Figure 12

OPERATING INSTRUCTIONS (CONT)

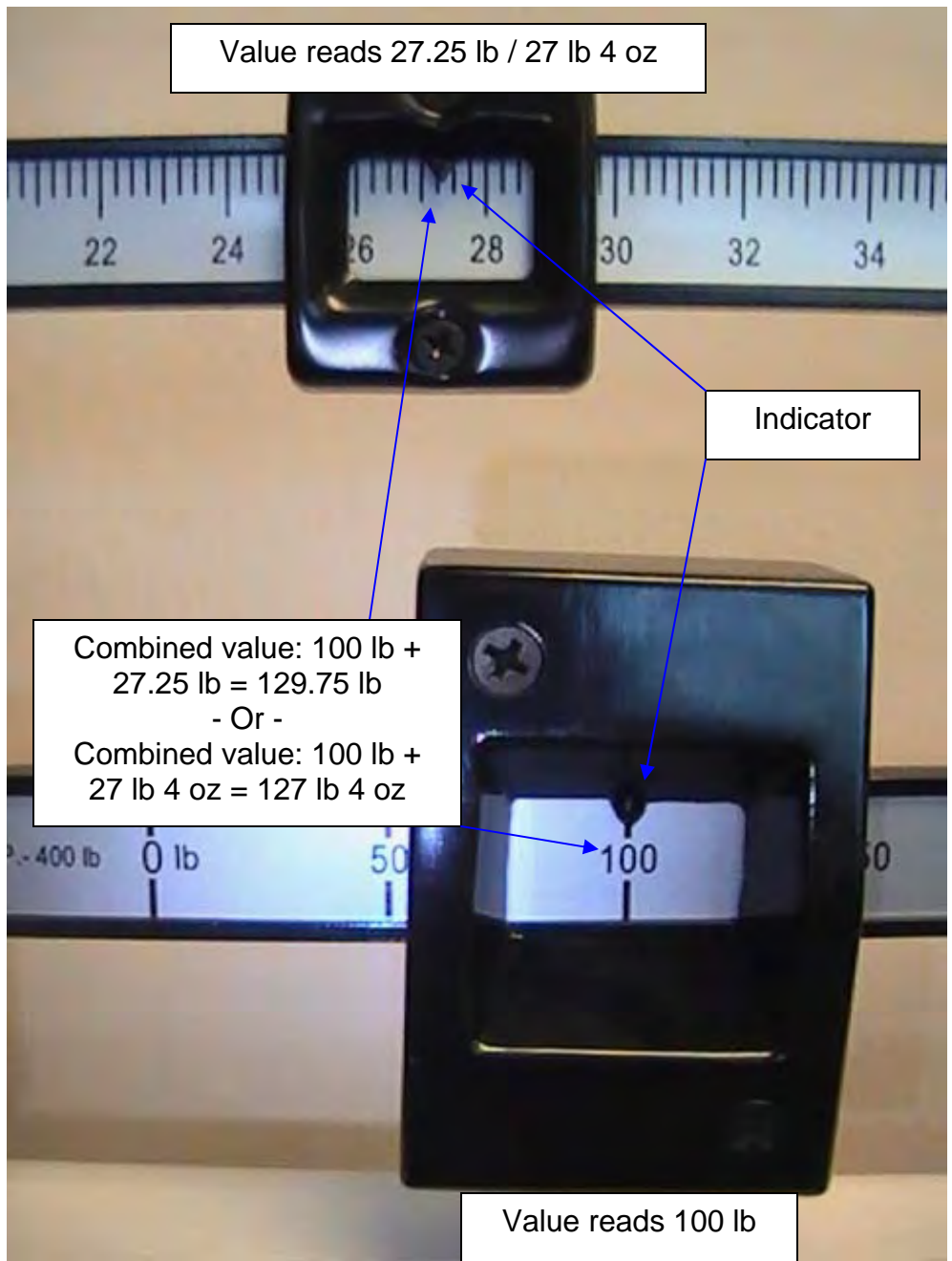

Figure 13

HEIGHT MEASUREMENT INSTRUCTIONS

Height Measurements (Refer to figures 14-20)

Note: A patient needs to be a minimum of 23-5/8" (600mm) in height for the height to be accurately measured.

1. Raise the headpiece above the patient's head.
2. Position the patient against the height rod.
3. Ensure that the patient's posture is upright, and that the patient's head is straight and level.
4. Push the headpiece down until it rests on the patient's head.
5. Determine the patient's height by reading the value on the measuring strip nearest to the line on the indicator (see Figures 18 - 20).



Figure 14



Figure 15



Figure 16

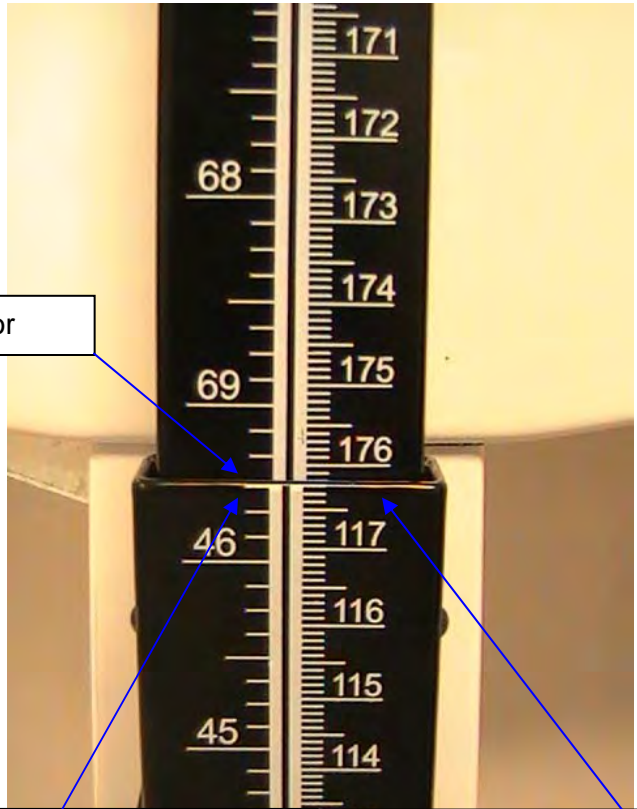
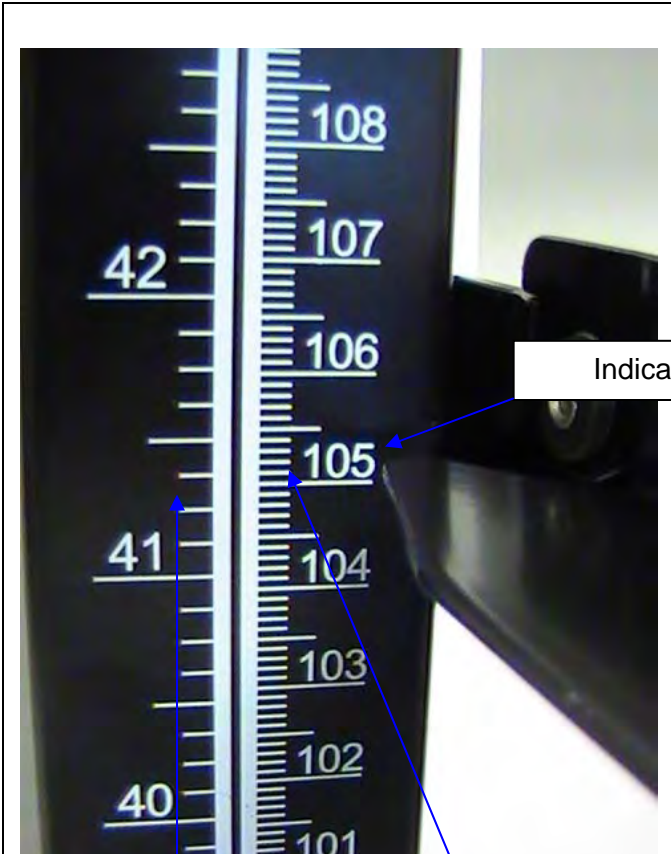

Figure 17

HEIGHT MEASUREMENT INSTRUCTIONS

Height Rod Below 46 3/8"

Height Rod Extended Above 46 3/8"



Inches read: 41" + 3/8" = 41 3/8"

Cm read: 105 cm + 0.2 cm = 105.2 cm

Inches read: 69" + 3/8" = 69 3/8"

Cm read: 176 cm + 0.2 cm = 176.2 cm

Figure 18

Figure 19

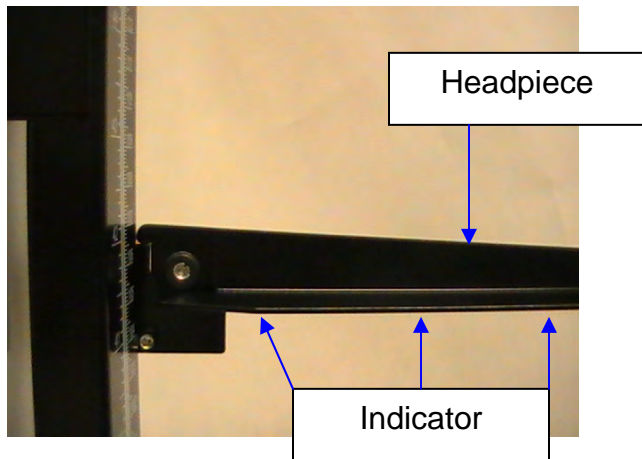

Figure 20

TROUBLESHOOTING

Troubleshooting

Before contacting service personnel, refer to the following instructions to check and to correct any failures for incorrect weight measurements.

The accuracy of the 402LB scale when calibrated at the factory is within +/- ¼ pound. For the most accurate weight measurement, use the scale on a hard level surface and stand in the center of the platform. If the error seems excessive, check the following:

Symptom	Possible Cause	Corrective Action
Questionable weight, or the scale does not center equally in the trig loop when the poise weight is "0" value	Bar does not "0" balance	The balance ball must be balanced such that the pointer comes to rest in the center of the trig-loop when both poise weights are set at "0" value. Ensure that the large and small poise weights are firmly against the shoulder of the beam. Adjust the balance ball screw by turning the screw at the left end of the bar.
Bar does not move freely	Bar sticking or adjustment needed	Check if the pointer is touching the side of the trig loop in its range of travel. Realignment of the beam may be necessary if it is touching. Ensure that the large and small poise weights are firmly against the shoulder of the beam. Adjust the balance ball screw by turning the screw at the left end of the bar.
Platform rocks excessively or touches base at any corner	Base out of alignment	Contact technical support.
Beam does not move at all during weighing process	Scale may have improper steel rod connection or poise weight may have been set at a higher weight than patient's actual weight.	Reset the weights to a lower weight. Ensure the steel rod is connected properly; refer to "Assembly Instructions" on page 6.

For further assistance please contact technical support toll free at 1 (800)-638-3722.

MAINTENANCE

The following provide instructions for maintenance and cleaning for the 402LB. Maintenance operations other than those described in this manual should be performed by qualified service personnel.

MAINTENANCE

Before first use and after periods of non-use, check the scale for proper operation and function. If the scale does not operate correctly, refer to qualified service personnel.

1. Check overall appearance of the total scale for any obvious damage, wear and tear.
2. Do not store near chemicals, heaters or radiators.
3. Do not drop, kick, or jump on the scale.
4. This scale is a sensitive weighing device. Items such as clothing or towels placed or dropped on the scale may cause it to operate incorrectly. In order to prevent this, do not store or leave anything on the scale.
5. If your scale fails to work properly, do not attempt to dismantle it. This will void your warranty. See warranty information instructions on having your scale serviced.
6. All bearings and working parts are permanently lubricated. **DO NOT USE OIL OR LUBRICANTS.**

CLEANING

Proper care and cleaning is essential to ensure a long life of accurate and effective operation.

1. Clean all external surfaces with a clean damp cloth or tissue. Mild antimicrobial or antibacterial soap and water solution may be used. Dry with a clean soft cloth.
2. Do not immerse the scale into cleaning or other liquid solution.
3. Do not use abrasive cleaners.

WARRANTY

10-Year Limited Warranty

What does the Warranty Cover?

Health o meter[®] Professional scales are warranted from date of purchase against defects of materials or in workmanship for a period of ten (10) years. If product fails to function properly, return the product, freight prepaid and properly packed to Pelstar, LLC (see "To Get Warranty Service", below, for instructions). If the manufacturer determines that a defect of material or in workmanship exists, the customer's sole remedy will be repair or replacement of the scale at no charge. Replacement will be made with a new or remanufactured product or component. If the product is no longer available, replacement may be made with a similar product of equal or greater value. All parts including repaired and replaced parts are covered only for the original warranty period.

Who is Covered?

The original purchaser of the product must have proof of purchase to receive warranty service. Please save your invoice or receipt. Pelstar dealers or retail stores selling Pelstar products do not have the right to alter, or modify or any way change the terms and conditions of this warranty.

What is Excluded?

Your warranty does not cover normal wear of parts or damage resulting from any of the following: negligent use or misuse of the product, use on improper voltage or current, use contrary to the operating instructions, abuse including tampering, damage in transit, or unauthorized repair or alternations. Further, the warranty does not cover natural disasters, such as fire, flood, hurricanes and tornadoes. This warranty gives you specific legal rights, and you may also have other rights that vary from country to country, state to state, province to province or jurisdiction to jurisdiction.

To get Warranty Service make sure you keep your sales receipt or document showing proof of purchase. Call (+1) 800-638-3722 or (+1) 708-377-0600 to receive a return authorization (RA) number, which must be included on the return label. Attach your proof of purchase to your defective product along with your name, address, daytime telephone number and description of the problem. Carefully package the product and send with shipping and insurance prepaid to:

Pelstar, LLC
Attention R/A# _____
Return Department
9500 West 55th Street
McCook, IL 60525

If your scale is not covered by warranty, or has been damaged, an estimate of repair costs or replacement costs will be provided to you for approval, prior to servicing or replacing.



PELSTAR, LLC

9500 West 55th Street • McCook, IL 60525 • USA

1-800-638-3722 or 1-708-377-0600

PLEASE REGISTER YOUR SCALE FOR WARRANTY COVERAGE AT:
<http://www.homscal.es.com/customers/registration.aspx>

Health o meter[®] is a registered trademark of Sunbeam Products, Inc. used under license.

Health o meter[®] Professional products are manufactured, designed, and owned by Pelstar, LLC.

We reserve the right to improve, enhance, or modify Health o meter[®] Professional product features or specifications without notice.

© Pelstar, LLC 2013

