

SINGER
120U

MACHINE PARTS CHART
for
SINGER*

120u

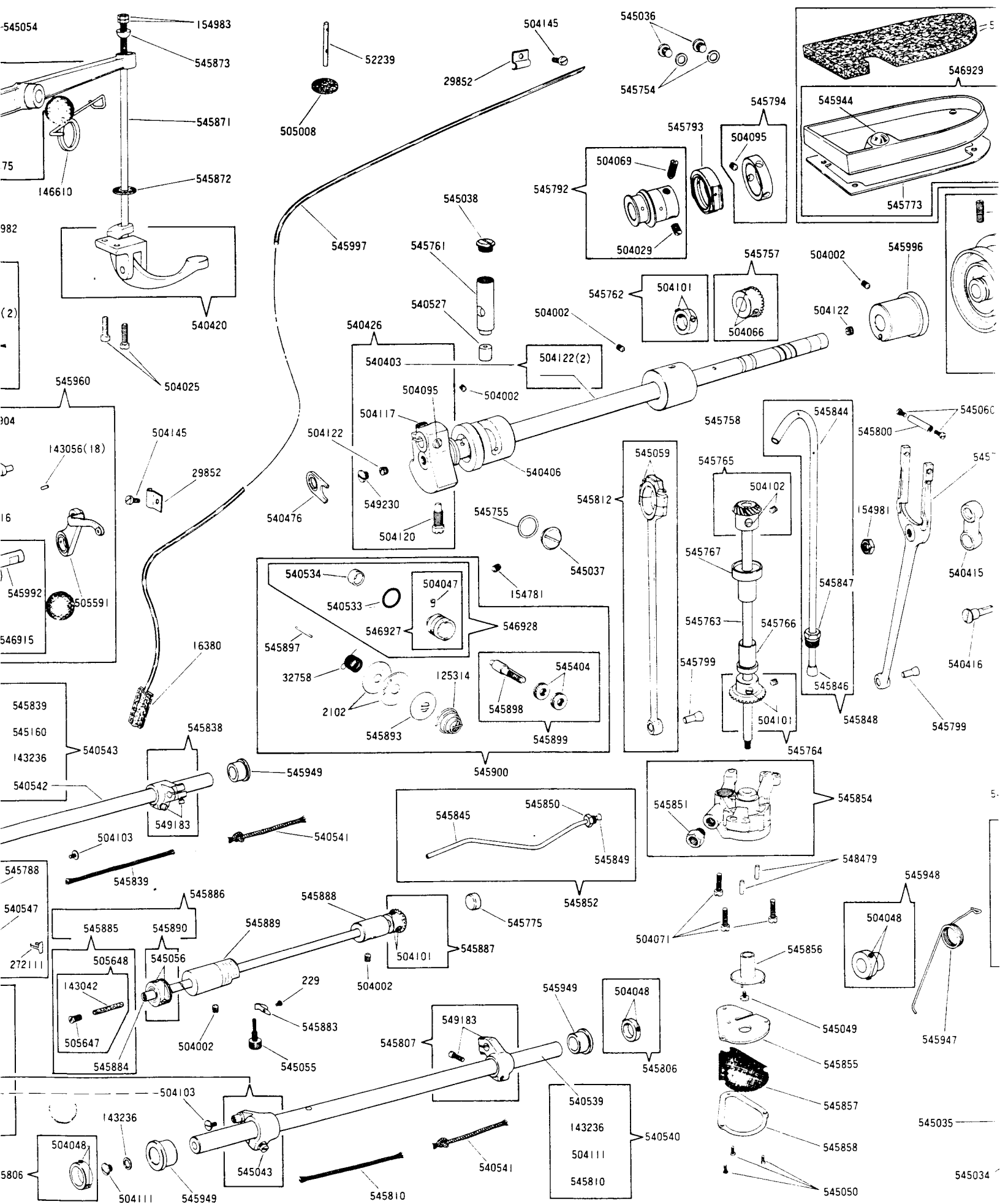

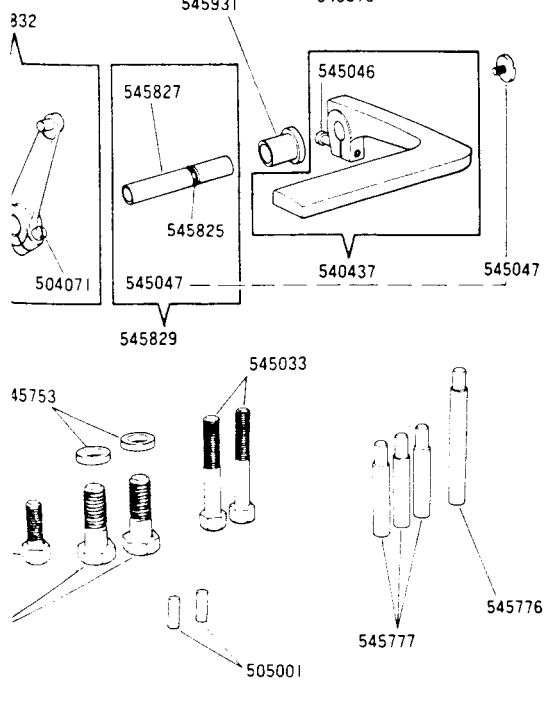
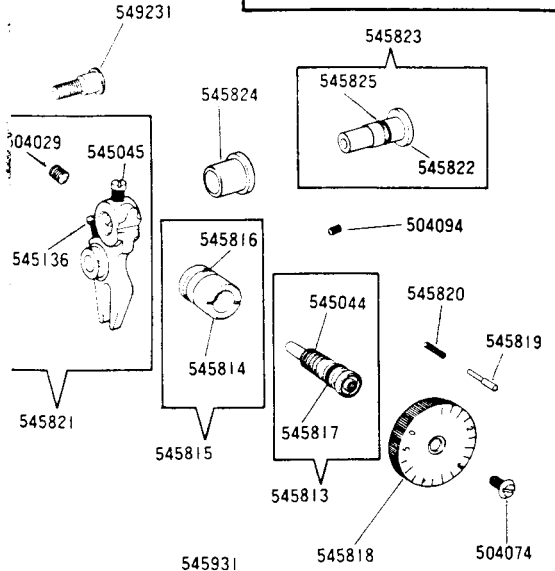
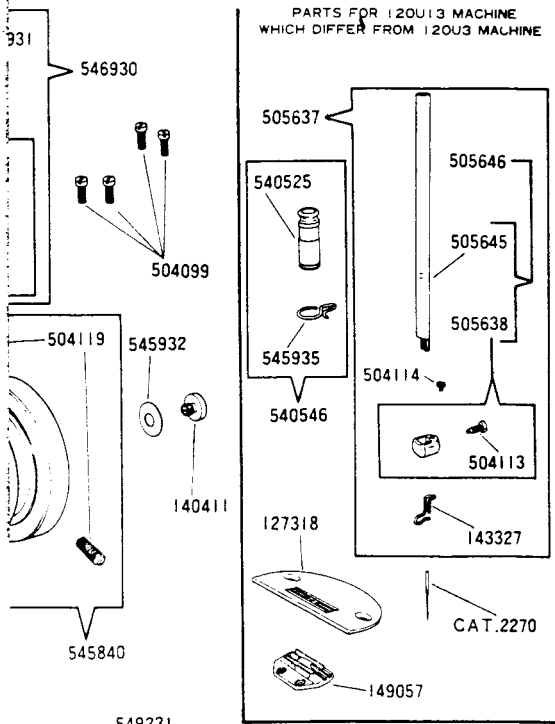

ACCESSORIES AND ATTACHMENTS

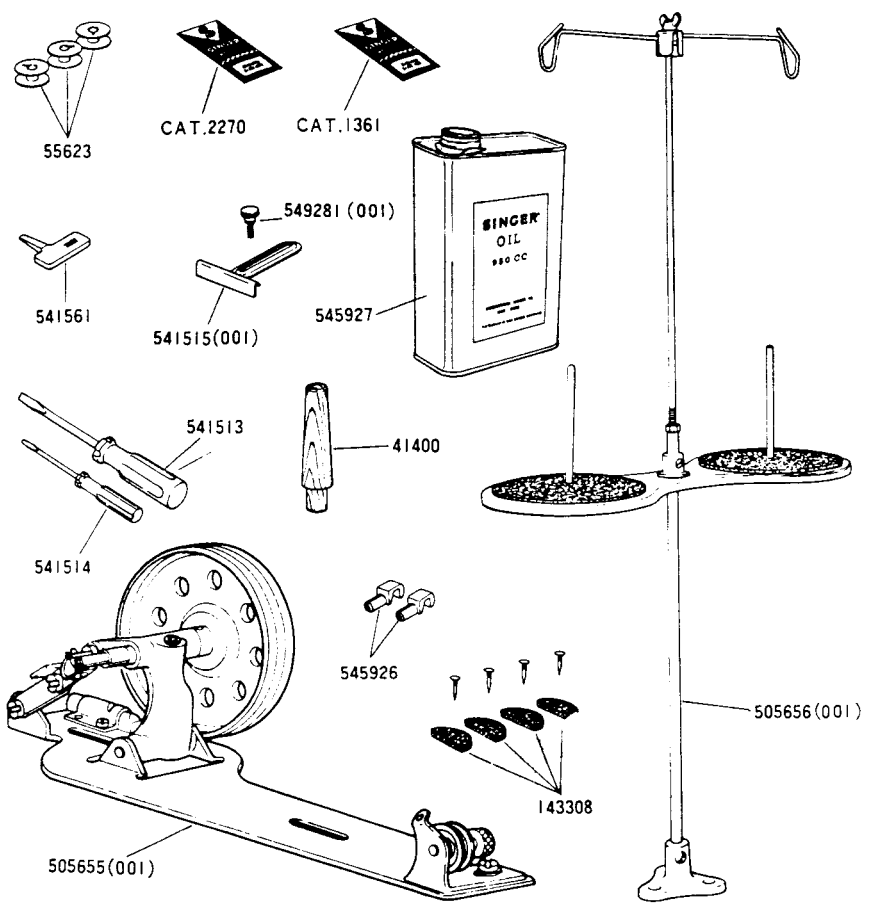

MACHINE BASE AND OIL RESERVOIR

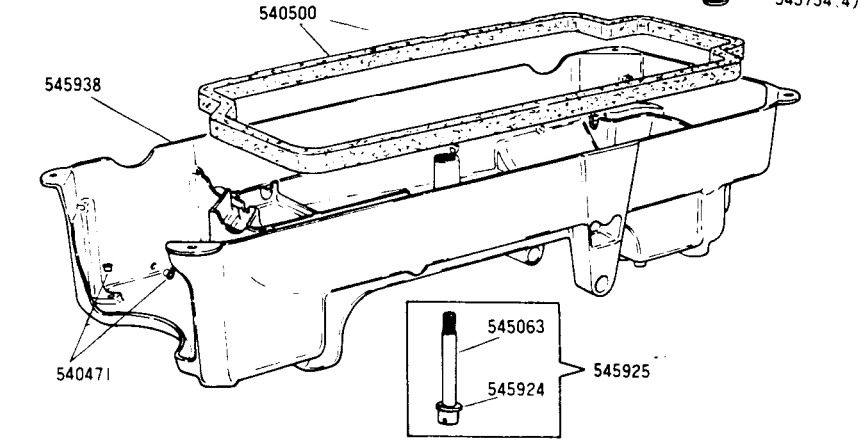

KNEE LIFTER PARTS

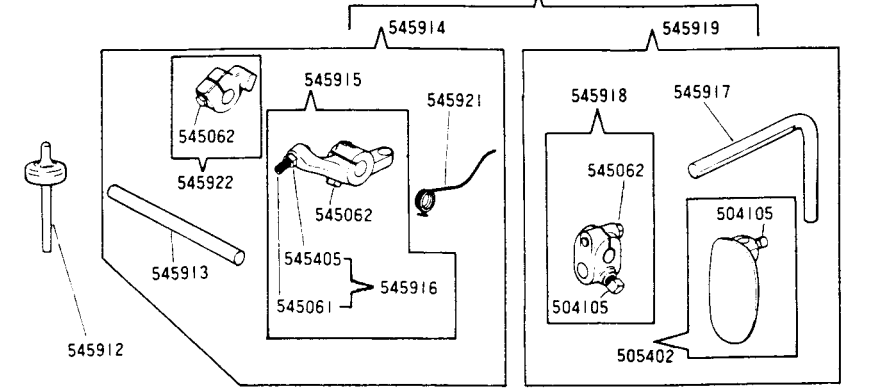

NUMERICAL LIST OF PARTS FOR MACHINE 120U3

<u>PART NO.</u>	<u>DESCRIPTION</u>	<u>PART NO.</u>	<u>DESCRIPTION</u>
229 (805)	Rotating Hook Oil Flow Regulating Thumb Screw Spring Screw	504099 (809)	Arm Top Cover Screw (4)
691 (850)	Throat Plate Screw (2)	504101 (850)	Arm Shaft (horizontal) Thrust Collar Set Screw (2)
2102	Tension Disc (2)	504101 (850)	Arm Shaft (upright) Bevel Gear (lower) Set Screw (2)
1	Bed Slide	504101 (850)	Rotating Hook Shaft Bevel Gear Set Screw (2)
1030	Oil Removing Lint Screen	504102 (833)	Arm Shaft (upright) Bevel Gear (upper) Set Screw (2)
29852	Oil Removing Tube Retaining Clamp (2)	504103 (803)	Feed Bar Connecting Link Cap Screw (2)
32390	Rotating Hook Bobbin Case Holder Position Bracket	504111 (809)	Feed Lifting Rock Shaft Oil Plug Screw
32758	Thread Take-up Spring	504112 (832)	Needle Set Screw
40394	Rotating Hook Bobbin Case Tension Spring	504117 (850)	Thread Take-up Crank Clamping Screw
50169 (809)	Needle Bar Thread Guard Screw	504118 (803)	Needle Bar Connecting Link Cap Screw
52033	Throat Plate (small needle hole)	504119 (850)	Machine Pulley Set Screw (2)
52171	Needle Bar Bushing (lower) Thread Eyelet	504120 (850)	Needle Bar Crank Position Screw
52239	Arm Spool Pin and Thread Eyelet	504122 (819)	Arm Shaft (horizontal) Oil Plug Screw (2)
52454	Thread Retainer	504129 (850)	Presser Bar Bushing (lower) Set Screw
55623	Rotating Hook Bobbin	504145 (809)	Oil Removing Tube Retaining Clamp Screw (2)
125314	Tension Spring	505001	Arm Dowel Pin (2)
140411 (802)	Arm Shaft (horizontal) Screw (back)	505008	Arm Spool Pin Washer (felt)
143042	Rotating Hook Shaft Oil Filter Wick	505131	Tension Releasing Lever Hinge Pin
143056	Needle Bar Connecting Link Roller Bearing (18)	505152	Tension Releasing Lever Spring
143056	Thread Take-up Lever Roller Bearing (18)	505317	Bed Slide complete, Nos. 12431, 154884 and two 154789
143236	Feed Lifting Rock Shaft Oil Plug Screw Washer (fiber)	505349	Rotating Hook Bobbin Case
143236	Feed Rock Shaft Oil Plug Screw Washer (fiber)	505350	Rotating Hook Bobbin Case 505349 with 40394, 504086 (806) and 504087 (806)
146610	Presser Bar Lifting Lever Spring	505351	Rotating Hook Bobbin Case Hinge, Nos. 505353, 505354 and 505355
149031	Feed Dog, 19 teeth (22 teeth to the inch)	505353	Rotating Hook Bobbin Case Latch
149111 (701)	Face Plate Plug	505354	Rotating Hook Bobbin Case Latch Lever
154781 (850)	Presser Bar Lifting Lever Pin Set Screw	505355	Rotating Hook Bobbin Case Latch Lever Fulcrum Pin
154781 (850)	Thread Take-up Spring Regulator Set Screw	505356	Rotating Hook Bobbin Case Latch Spring
154789 (809)	Bed Slide Spring Screw (2)	505358	Rotating Hook Bobbin Case complete, Nos. 504032 (805), 505350, 505351 and 505356
154884	Bed Slide Spring	505569	Needle Bar Connecting Link
154981 (819)	Feed Connecting Link Screw Nut	505575	Presser Bar Spring
154983 (819)	Presser Bar Lifting Lever Connecting Rod Nut (2)	505591	Thread Take-up Lever
272111	Feed Bar Connecting Link Oil Wick Clamp	505643	Presser Foot (spring hinged) complete
504002 (850)	Arm Shaft (horizontal) Bushing (center) Set Screw	505647	Rotating Hook Shaft Oil Filter Wick Holder
504002 (850)	Arm Shaft (horizontal) Flanged Bushing (back) Set Screw	505648	Rotating Hook Shaft Oil Filter complete, Nos. 143042 and 505647
504002 (850)	Arm Shaft (horizontal) Flanged Bushing (front) Set Screw	505649	Presser Bar Bushing (lower)
504002 (850)	Rotating Hook Shaft Bushing (back) Set Screw	540403	Arm Shaft (horizontal) with two 504122 (819)
504002 (850)	Rotating Hook Shaft Bushing (front) Set Screw	540406	Arm Shaft (horizontal) Flanged Bushing (front)
504002 (850)	Thread Take-up Lever Link Hinge Stud Set Screw	540415	Feed Connecting Link
504010 (829)	Arm Side Shield Screw (2)	540416	Feed Connecting Link Stud
504010 (829)	Thread Take-up Lever Guard Screw	540420	Bell Crank complete
504010 (829)	Thread Take-up Lever Oil Guard Screw	540426	Arm Shaft (horizontal) and Needle Bar Crank, Nos. 504095 (850), 504117 (850), 504120 (850), 540403 and 549230 (805)
504013 (850)	Feed Bar Carrier Clamping Screw (2)	540437	Feed Reverse Lever with 545046 (809)
504013 (850)	Feed Bar Hinge Pin Clamping Screw	540476	Thread Take-up Crank Wearing Plate
504025 (850)	Bell Crank Bracket Set Screw (2)	540524	Needle Bar Bushing (lower)
504028 (850)	Feed Rock Shaft Flanged Bushing (front) Set Screw	540527	Thread Take-up Lever Oil Wick Holder Plug
504028 (850)	Needle Bar Bushing (lower) Set Screw	540528	Needle Bar Bushing (lower) Felt
504028 (850)	Needle Bar Bushing (upper) Set Screw	540533	Thread Take-up Spring Regulator O-ring
504029 (833)	Feed and Feed Lifting Eccentric Set Screw	540534	Thread Take-up Spring Regulator Rubber Cap
504029 (833)	Feed Regulator Screw	540536	Feed Bar Carrier
504032 (805)	Rotating Hook Bobbin Case Latch Stop Screw	540537	Feed Bar Carrier 540536 with three 504013 (850)
504047 (833)	Tension Stud Set Screw	540538	Feed Bar Carrier Oil Wick
504048	Feed Lifting Rock Shaft Collar Set Screw (Spec. 1050) (4)	540539	Feed Lifting Rock Shaft
504048	Feed Reverse Lever Hinge Stud Collar Set Screw (Spec. 1050) (2)	540540	Feed Lifting Rock Shaft complete, Nos. 143236, 504111 (809), 540539 and 545810
504048	Feed Rock Shaft Collar Set Screw (Spec. 1050) (2)	540541	Feed Lifting Rock Shaft Oil Wick (outer)
504051 (850)	Feed Dog Screw (2)	540541	Feed Rock Shaft Oil Wick (outer)
504063 (825)	Presser Foot Screw	540542	Feed Rock Shaft
504063 (809)	Slack Thread Regulator Screw	540543	Feed Rock Shaft complete, Nos. 143236, 540542, 545160 (809) and 545839
504066 (833)	Arm Shaft (horizontal) Bevel Gear Set Screw (2)	540544	Feed Bar 545987 with 540537, 545789, 545791, 545808 and two 504103 (803)
504069 (833)	Feed and Feed Lifting Eccentric Position Screw	540547	Feed Bar Connecting Link Oil Wick
504071 (833)	Feed Reverse Lever Link Clamping Screw	545033 (805)	Arm Screw (back) (2)
504071 (833)	Oil Pump (centrifugal) (body) Screw (3)	545034 (805)	Arm Screw (front) (2)
504074 (852)	Feed Regulating Stud Head Cap Screw	545035 (805)	Arm Screw (intermediate)
504084 (810)	Rotating Hook Bobbin Case Holder Position Bracket Screw	545036 (819)	Arm Shaft (upright) Bevel Gear (upper) Set Screw Hole Plug Screw
504087 (806)	Rotating Hook Bobbin Case Tension Regulating Screw	545036 (819)	Feed Regulator Set Screw Hole Plug Screw
504087 (806)	Rotating Hook Bobbin Case Tension Spring Screw	545037 (819)	Thread Take-up Crank Clamping Screw Hole Plug Screw
504094 (833)	Feed Regulating Stud Bushing Set Screw		
504094 (833)	Thread Retainer Set Screw		
504095 (850)	Feed and Feed Lifting Eccentric Sleeve Retaining Collar Set Screw		
504095 (850)	Thread Take-up Crank Set Screw		

NUMERICAL LIST OF PARTS FOR MACHINE 120U3

<u>PART NO.</u>	<u>DESCRIPTION</u>	<u>PART NO.</u>	<u>DESCRIPTION</u>
545925	Machine and Machine Base and Oil Reservoir Screw 545063 (805) with 545924 (for shipping purposes only)		
545938	Machine Base and Oil Reservoir		

NUMERICAL LIST OF PARTS FOR MACHINE 120U3

<u>PART NO.</u>	<u>DESCRIPTION</u>	<u>PART NO.</u>	<u>DESCRIPTION</u>
545038 (819)	Arm Shaft (horizontal) Flanged Bushing (front) Oil Tube Cap Screw	545806	Feed Lifting Rock Shaft Collar with two 504048 (Spec. 1050) (2)
545040 (809)	Face Plate Screw (3)	545807	Feed Lifting Rock Shaft Crank (back) with two 549183 (850)
545043 (819)	Feed Lifting Rock Shaft Crank (front) Clamping Screw	545808	Feed Lifting Rock Shaft Crank (front) with 545043 (819)
545044 (803)	Feed Regulating Stud	545810	Feed Lifting Rock Shaft Oil Wick
545045 (833)	Feed Regulator Set Screw	545812	Feed Lifting Rock Shaft Crank Connecting Rod with two 545059 (810)
545046 (809)	Feed Reverse Lever Clamping Screw	545813	Feed Regulating Stud 545044 (803) with 545817
545047 (850)	Feed Reverse Lever Hinge Stud Cap Screw	545814	Feed Regulating Stud Bushing
545049 (805)	Oil Pump (centrifugal) Impeller Locking Screw	545815	Feed Regulating Stud Bushing 545814 with 545816
545050 (805)	Oil Pump (centrifugal) Screen Frame Screw (3)	545816	Feed Regulating Stud Bushing O-ring
545051 (850)	Oil Wick Holder Screw	545817	Feed Regulating Stud O-ring
545053 (850)	Presser Bar Lifter Hinge Screw	545818	Feed Regulating Stud Head
545054 (850)	Presser Bar Lifting Lever Hinge Screw	545819	Feed Regulating Stud Head Lock Pin
545055 (805)	Rotating Hook Oil Flow Regulating Thumb Screw	545820	Feed Regulating Stud Head Lock Pin Spring
545056 (803)	Rotating Hook Shaft Oil Retaining Collar Set Screw (2)	545821	Feed Regulator with 504029 (833), 545045 (833) and 545136 (830)
545057 (819)	Tension Releasing Lever Screw	545822	Feed Regulator Hinge Stud
545059 (810)	Feed Lifting Rock Shaft Crank Connecting Rod Cap Screw (2)	545823	Feed Regulator Hinge Stud 545822 with 545825
545060 (833)	Feed Forked Connection Sleeve Screw (2)	545824	Feed Regulator Hinge Stud Flanged Bushing
545099 (803)	Presser Bar Guide Bracket Clamping and Tension Releaser Screw	545825	Feed Regulator Hinge Stud O-ring
545136 (830)	Feed Connecting Link Stud Set Screw	545825	Feed Reverse Lever Hinge Stud O-ring
545160 (809)	Feed Rock Shaft Oil Plug Screw	545827	Feed Reverse Lever Hinge Stud
545340 (806)	Needle Bar Connecting Stud Clamping Screw	545829	Feed Reverse Lever Hinge Stud 545827 with 54504 (850) and 545825
545403 (819)	Presser Bar Guide and Pressure Regulating Thumb Screw Lock Nut	545832	Feed Reverse Lever Link with 504071 (833)
545404 (809)	Tension Regulating Thumb Nut (2)	545836	Feed Rock Shaft Flanged Bushing (front)
545753	Arm Screw (front) Washer (2)	545837	Feed Rock Shaft Collar with two 504048 (Spec. 1050)
545754	Arm Shaft (upright) Bevel Gear (upper) Set Screw Hole Plug Screw Gasket	545838	Feed Rock Shaft Crank with two 549183 (850)
545754	Feed Regulator Set Screw Hole Plug Screw Gasket	545839	Feed Rock Shaft Oil Wick
545755	Thread Take-up Crank Clamping Screw Hole Plug Screw Gasket	545840	Machine Pulley with two 504119 (850)
545757	Arm Shaft (horizontal) Bevel Gear with two 504066 (833)	545841	Needle Bar Bushing (upper)
545758	Arm Shaft (horizontal) Bushing (center)	545844	Oil Pipe
545761	Arm Shaft (horizontal) Flanged Bushing (front) Oil Tube	545845	Oil Pipe
545762	Arm Shaft (horizontal) Thrust Collar with two 504101 (850)	545846	Oil Pipe Clamping Sleeve
545763	Arm Shaft (upright)	545847 (805)	Oil Pipe Clamping Sleeve Nut
545764	Arm Shaft (upright) Bevel Gear (lower) Right Hand Spiral with two 504101 (850)	545848	Oil Pipe complete, from Oil Pipe to Arm Shaft (horizontal) Bushing (center) Nos. 545844, 545846 and 545847 (805)
	Note: To ensure proper functioning of Gears, No. 545764 will not be supplied separately but will be substituted by pair of Gears No. 545862.	545849	Oil Pipe Clamping Sleeve
545765	Arm Shaft (upright) Bevel Gear (upper) Left Hand Spiral with two 504102 (833)	545850 (805)	Oil Pipe Clamping Sleeve Nut
	Note: To ensure proper functioning of Gears, No. 545765 will not be supplied separately but will be substituted by pair of Gears No. 545863.	545851	Oil Pipe Clamping Sleeve Nut Adapter
545766	Arm Shaft (upright) Bushing (lower)	545852	Oil Pipe 545845 with 545849 and 545850 (805) for Oiling Rotating Hook Shaft Bearing (front)
545767	Arm Shaft (upright) Bushing (upper)	545854	Oil Pump (centrifugal) (body) with 545851
545768	Arm Side Shield	545855	Oil Pump (centrifugal) Cover
545769	Arm Side Shield complete, Nos. 545768, 545770 and 545771	545856	Oil Pump (centrifugal) Impeller
545770	Arm Side Shield Wick Spring Holder	545857	Oil Pump (centrifugal) Screen
545771	Arm Side Shield Wick	545858	Oil Pump (centrifugal) Screen Frame
545773	Arm Top Cover Gasket	545859	Oil Wick (2)
545775	Bed Hole Plug	545860	Oil Wick Holder
545776	Bed Leg (long)	545861	Oil Wick Holder 545860 with 545051 (850) and two 545859
545777	Bed Leg (short) (3)	545862	Pair of Gears Nos. 545764 and 545887
545788	Feed Bar Connecting Link	545863	Pair of Gears Nos. 545757 and 545765
545789	Feed Bar Connecting Link 545788 with 272111 and 540547	545864	Presser Bar (hollow)
545791	Feed Bar Hinge Pin	545868	Presser Bar Lifter
545792	Feed and Feed Lifting Eccentric with 504029 (833) and 504069 (833)	545869	Presser Bar Lifting Lever
545793	Feed and Feed Lifting Eccentric Sleeve	545870	Presser Bar Lifting Lever 545869 with 154781 (850) and 545875
545794	Feed and Feed Lifting Eccentric Sleeve Retaining Collar with 504095 (850)	545871	Presser Bar Lifting Lever Connecting Rod
545797	Feed Forked Connection	545872	Presser Bar Lifting Lever Connecting Rod Oil Mist Retaining Disc (felt)
545799	Feed Forked Connection Hinge Stud	545873	Presser Bar Lifting Lever Connecting Rod Swivel
545799	Feed Forked Connection Hinge Stud	545875	Presser Bar Lifting Lever Pin
545799	Feed Lifting Rock Shaft Crank Connecting Rod Hinge Stud	545876	Presser Bar Guide and Pressure Regulating Thumb Screw 549363 (819) with 545403 (819)
545800	Feed Forked Connection Sleeve	545883	Rotating Hook Oil Flow Regulating Thumb Screw Spring
		545884	Rotating Hook Shaft
		545885	Rotating Hook Shaft 545884 with 505648
		545886	Rotating Hook Shaft 545885 with 545890
		545887	Rotating Hook Shaft Bevel Gear (left hand sp with two 504101 (850)

Note: To ensure proper functioning of Gears,
No. 545887 will not be supplied separately bu
will be substituted by pair of Gears No. 5458

NUMERICAL LIST OF PARTS FOR MACHINE 120U3

<u>PART NO.</u>	<u>DESCRIPTION</u>	<u>PART NO.</u>	<u>DESCRIPTION</u>
545888	Rotating Hook Shaft Bushing (back)	CAT.1361	Needle (88 x 9 #14)
545889	Rotating Hook Shaft Bushing (front)		
545890	Rotating Hook Shaft Oil Retaining Collar with two 545046 (803)		
			<u>KNEE LIFTER PARTS</u> (Supplied with Machine)
545892	Slack Thread Regulator	504105 (809)	Rock Shaft Knee Arm Plate Set Screw
545893	Tension Releasing Disc	504105 (809)	Rock Shaft Knee Arm Plate Set Screw
545894	Tension Releasing Lever (body)	505402	Rock Shaft Knee Arm Plate with 504105 (809)
545895	Tension Releasing Lever (body) 545894 with 545057 (819) and 545896	545061 (803)	Rock Shaft Crank Adjusting Screw
545896	Tension Releasing Lever Segment	545062 (833)	Rock Shaft Crank Clamping Screw
545897	Tension Releasing Pin	545062 (833)	Rock Shaft Knee Arm Hub Clamping Screw
545898	Tension Stud	545062 (833)	Rock Shaft Stop Dog Clamping Screw
545899	Tension Stud 545898 with two 545404 (809)	545405 (809)	Rock Shaft Crank Adjusting Screw Lock Nut
545900	Tension complete, Nos. 32758, 125314, 546928, 545893, 545897, 545899 and two 2102	545912	Bell Crank Plunger
		545913	Rock Shaft
545901	Thread Eyelet (side of arm)	545914	Rock Shaft 545913 with 545915, 545921 and 545922
545902 (701)	Thread Take-up Lever Guard	545915	Rock Shaft Crank with 545062 (833) and 545916
545903	Thread Guard (side of arm)	545916	Rock Shaft Crank Adjusting Screw 545061 (803) with 545405 (809)
545904	Thread Take-up Lever Link		
545905	Thread Take-up Lever Link Hinge Stud	545917	Rock Shaft Knee Arm
545906	Thread Take-up Lever Link Hinge Stud Oil Wick	545918	Rock Shaft Knee Arm Hub with 504105 (809) and 545062 (833)
545907	Thread Take-up Lever Link Hinge Stud 545905 with 545906	545919	Rock Shaft Knee Arm complete, Nos. 505402, 545917 and 545918
545908	Thread Take-up Lever Oil Guard with 545909	545921	Rock Shaft Spring
545909	Thread Take-up Lever Oil Guard Wick	545922	Rock Shaft Stop Dog with 545062 (833)
545931	Feed Reverse Lever Hinge Stud Flanged Bushing	545923	Rock Shaft complete, Nos. 545914 and 545919
545932	Arm Shaft (horizontal) Screw (back) Gasket		
545940	Needle Bar (hollow) with 504112 (832)		
545941	Needle Bar Thread Guard		
545942	Needle Bar Thread Guard Screw Washer		
545944	Oil Flow Window	127318	Throat Plate (small needle hole), in place of 52033
545947	Feed Reverse Lever Link Spring	143327	Needle Bar Thread Guard
545948	Feed Reverse Lever Hinge Stud Collar with two 504048 (Spec. 1050)	149057	Feed Dog, 21 teeth (22 teeth to the inch), in place of 149031
545949	Feed Lifting Rock Shaft Flanged Bushing (2)	504113 (851)	Needle Clamp Screw
545949	Feed Rock Shaft Flanged Bushing (back)	504114 (809)	Needle Bar Thread Guard Screw
545950	Rotating Hook with two 549182 (803)	505637	Needle Clamp 505646 with 143327 and 504114 (809)
545951	Rotating Hook complete, Nos. 545950, 545954, 545955, three 549187 (803) and four 549186 (806)	505638	Needle Clamp with 504113 (851)
		505645	Needle Bar (hollow), in place of 545940
545954	Rotating Hook Section	505646	Needle Bar (hollow) 505645 with 505638
545955	Rotating Hook Thread Guard	540525	Needle Bar Bushing (lower), in place of 540524
545960	Thread Take-up complete, Nos. 505591, 545904, 545907, 546916 and eighteen 143056	540546	Needle Bar Bushing (lower) 540525 with 545935, in place of 546933
545982	Presser Bar Lifting Lever Link	545935	Needle Bar Bushing (lower) Thread Eyelet, in place of 52171
545983	Presser Bar Guide Bracket with 545099 (803)	CAT.2270	Needle (16 x 257 #16)
545987	Feed Bar (body)		
545990	Rotating Hook and Rotating Hook Bobbin Case Holder complete, Nos. 545951 and 545994		
545991	Rotating Hook, Rotating Hook Bobbin Case Holder and Rotating Hook Bobbin Case complete, Nos. 545990 and 505358		
		41400	<u>ACCESSORIES AND ATTACHMENTS</u> (Supplied with Machine)
545992	Thread Take-up Crank	55623	Machine Rest Pin (wood)
545994	Rotating Hook Bobbin Case Holder	143308	Rotating Hook Bobbin (3)
545995	Rotating Hook Bobbin Case 505358 with 545994 (for agent only)	505655 (001)	Machine Rest (felt) with wire nail (4)
		505656 (001)	Universal Bobbin Winder complete (include Wood Screw (2)) (purchased part)
545996	Arm Shaft (horizontal) Flanged Bushing (back)		Thread Unwinder (for two spools) complete (include Wood Screw (3)) (purchased part)
545997	Oil Removing Tube	541513	Screw Driver (large)
546914	Needle Bar Connecting Stud with 545340 (806)	541514	Screw Driver (small)
546915	Needle Bar Connecting Link 505569 with 546914	541515 (001)	Cloth Guide (purchased part)
546916	Thread Take-up Crank 545992 with 504118 (803), 546915 and eighteen 143056	541561	Wrench
		541562	Accessory Box
546925	Face Plate Gasket	545926	Machine Hinge Connection (2)
546927	Thread Take-up Spring Regulator with 504047 (833)	545927	Oil Can (950 cc, filled with Singer Tupe "C" Oil)
546928	Thread Take-up Spring Regulator 546927 with 540533 and 540534		
		549281 (001)	Cloth Guide Screw (purchased part)
546929	Arm Top Cover with 545944 and 545773	CAT.1361	Needle (88 x 9 #14) (for 120U3 M/C) (3)
546930	Arm Top Cover Assembly Nos. 546929 and 546931	CAT.2270	Needle (16 x 257 #16) (for 120U13 M/C) (3)
546931	Arm Top Cover Pin Cushion		
546933	Needle Bar Bushing (lower) 540524 with 52171		
546934	Face Plate with 149111 (701) and 546925		
548479	Oil Pump (centrifugal) (body) Position Pin (2)		
549182 (803)	Rotating Hook Set Screw (2)		
549183 (850)	Feed Lifting Rock Shaft Crank (back) Clamping Screw (2)	540471	Machine Base and Oil Reservoir Plug (2)
		540500	Machine Base and Oil Reservoir Gasket
549183 (850)	Feed Rock Shaft Crank Clamping Screw (2)	545036 (819)	Oil Reservoir Oil Drain Plug Screw
549186 (806)	Rotating Hook Thread Guard Screw (4)	545063 (805)	Machine and Machine Base and Oil Reservoir Screw (for shipping purposes only)
549187 (803)	Rotating Hook Section Screw (3)		
549230 (805)	Arm Shaft (horizontal) Screw Plug (front)	545064 (805)	Machine and Machine Base and Oil Reservoir Screw Hole Plug Screw
549231 (803)	Feed Connecting Link Screw		
549363 (819)	Presser Bar Guide and Pressure Regulating Thumb Screw	545754	Oil Reservoir Oil Drain Plug Screw Gasket (4)
		545924	Machine and Machine Base and Oil Reservoir Screw Spring Washer (for shipping purposes only)