

Installation and Operating Guide | Warranty

Model Number LMG340 High-Performance, Mini Component CD System
Compact Disc Player System with Speakers

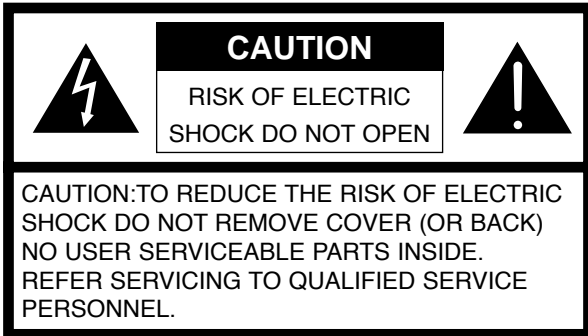

Precautions



Graphical Symbols Explanation:



The lightning flash with arrowhead symbol, within an equilateral triangle is intended to alert the user to the presence of uninsulated dangerous voltage within the product's enclosure that may be of sufficient magnitude to constitute a risk of electric shock to persons.



The exclamation point within an equilateral triangle is intended to alert the user to the presence of important operating and maintenance (servicing) instructions in the literature accompanying the appliance.

WARNING

TO REDUCE THE RISK OF FIRE OF ELECTRIC SHOCK, DO NOT EXPOSE THIS APPLIANCE TO RAIN OR MOISTURE.

To avoid electrical shock, do not open the cabinet, Refer servicing to qualified personnel only.

The apparatus shall not be exposed to dripping or splashing and that no objects filled with liquids, such as vases, shall be placed on the apparatus.

Warning:

Do not install this equipment in a confined space such a book case or similar unit.

CAUTION

Use of controls or adjustments or performance of procedures other than those specified herein may result in hazardous radiation exposure.

Laser component in this product is capable of emitting radiation exceeding the limit for Class 1.

CAUTION: INVISIBLE LASER RADIATION WHEN OPEN AND INTERLOCKS DEFEATED. AVOID EXPOSURE TO THE BEAM.

WARNING: OSYNLIG LASERSTRÅLNING NÅR DENNA DEL ÄR ÖPPNAD STRÅLEN ÄR FARLIG.

Attention: Quand l'appareil est ouvert, ne pas s'exposer aux radiations invisibles du faisceau laser.

This label is located on the interior.

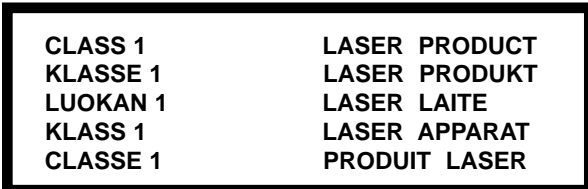

This Compact Disc player is classified as a CLASS 1 LASER product.

The CLASS 1 LASER PRODUCT label is located on the exterior.

REGULATORY INFORMATION:

FCC Part 15

This product has been tested and found to comply with the limits for a Class B digital device, pursuant to Part 15 of the FCC Rules. These limits are designed to provide reasonable protection against harmful interference when the product is operated in a residential installation. This product generates, uses and can radiate radio frequency energy and, if not installed and used in accordance with the instruction manual, may cause harmful interference to radio communications. However, there is no guarantee that interference will not occur in a particular installation. If this product does cause harmful interference to radio or television reception, which can be determined by turning the product off and on, the user is encouraged to try to correct the interference by one or more of the following measures:

- Reorient or relocate the receiving antenna.
- Increase the separation between the product and receiver.
- Connect the product into an outlet on a circuit different from that to which the receiver is connected.
- Consult the dealer or an experienced radio/TV technician for help.

FCC WARNING: This equipment may generate or use radio frequency energy. Changes or modifications to this equipment may cause harmful interference unless the modifications are expressly approved in the instruction manual. The user could lose the authority to operate this equipment if an unauthorized change or modification is made.

IMPORTANT SAFETY INSTRUCTIONS

CAUTION: PLEASE READ AND OBSERVE ALL WARNINGS AND INSTRUCTIONS IN THIS OWNER'S MANUAL AND THOSE MARKED ON THE UNIT. RETAIN THIS BOOKLET FOR FUTURE REFERENCE.

This set has been designed and manufactured to assure personal safety. Improper use can result in electric shock or fire hazard. The safeguards incorporated in this unit will protect you if you observe the following procedures for installation, use, and servicing.

This unit does not contain any parts that can be repaired by the user.

DO NOT REMOVE THE CABINET COVER, OR YOU MAY BE EXPOSED TO DANGEROUS VOLTAGE. REFER SERVICING TO QUALIFIED SERVICE PERSONNEL ONLY.

- 1. Read these instructions.** - All these safety and operating instructions should be read before the product is operated.
- 2. Keep these instructions.** - The safety, operating and use instructions should be retained for future reference.
- 3. Heed all warnings.** - All warnings on the product and in the operating instructions should be adhered to.
- 4. Follow all instructions.** - All operating and use instructions should be followed.
- 5. Do not use this apparatus near water.** - For example: near a bath tub, wash bowl, kitchen sink, laundry tub, in a wet basement; or near a swimming pool; and like.
- 6. Clean only with dry cloth.** - Unplug this product from the wall outlet before cleaning. Do not use liquid cleaners.
- 7. Do not block any ventilation openings. Install in accordance with the manufacturer's instructions.** - Slots and openings in the cabinet are provided for ventilation and to ensure reliable operation of the product and to protect it from over- heating. The openings should never be blocked by placing the product on a bed, sofa, rug or other similar surface. This product should not be placed in a built-in installation such as a bookcase or rack unless proper ventilation is provided or the manufacturer's instructions have been adhered to.
- 8. Do not install near any heat sources such as radiators, heat registers, stoves, or other apparatus (including amplifiers) that produce heat.**
- 9. Do not defeat the safety purpose of the polarized or grounding-type plug.** A polarized plug has two blades with one wider than the other. A grounding type plug has two blades and a third grounding prong. The wide blade or the third prong are provided for your safety. If the provided plug does not fit into your outlet, consult an electrician for replacement of the obsolete outlet.
- 10. Protect the power cord from being walked on or pinched particularly at plugs, convenience receptacles, and the point where they exit from the apparatus.**
- 11. Only use attachments/accessories specified by the manufacturer.**
- 12. Use only with the cart, stand, tripod, bracket, or table specified by the manufacturer, or sold with apparatus. When a cart is used, use caution when moving the cart/apparatus combination to avoid injury from tip-over.**
- 13. Unplug this apparatus during lightning storms or when unused for long periods of time.**
- 14. Refer all servicing to qualified service personnel. Servicing is required when the apparatus has been damaged in any way, such as power-supply cord or plug is damaged, liquid has been spilled or objects have fallen into the apparatus, the apparatus has been exposed to rain or moisture, does not operate normally, or has been dropped.**



Table of Contents

INTRODUCTION

Precautions 2

IMPORTANT SAFETY INSTRUCTIONS 3

Table of Contents 4

Before Use 5

Safety Precautions 5

Notes on Discs 5

Notes on Remote Control 5

Notes on Tapes 5

Front Panel/ Rear Panel 6

Remote Control 7

Display Window 7

Connections 8

Speaker System Connection 8

Antenna (Aerial) Connections 8

BEFORE OPERATION

Setting the CLOCK 9

Sleep Function 9

Using Microphone 9

Timer Function 10

Audio Adjustment 11

Volume Adjustment 11

Sound Quality Adjustment 11

MUTE 11

SURROUND 11

DISPLAY MODE 11

XDSS (Extreme Dynamic Sound System) 11

DEMO 11

DIMMER 11

Auxiliary (External Equipment) Input 11

OPERATION

Presetting the Radio Stations (Channel Search) . 12

Listening to the Radio 13

Tape Playback 14

Basic Playback 14

To Stop Play 14

Tape Counter Reset 14

To Play Fast Rewind or Fast Forward 14

Dubbing 14

Recording Setup 15

Basic Recording Setups 15

Recording from Radio, CD or Auxiliary source . . 15

CD to Tape Synchronized Recording 15

CD Playback 16

Basic Playback Setup 16

To Pause Play 16

To Stop Play 16

To Skip a Track 16

To Fast Rewind or Fast Forward 16

To Go to the Next Disc 16

To Select a Disc Directly 16

To Exchange Discs During Playback 17

To Repeat Play 17

Program Play Setup 18

Reference

Troubleshooting 19

Specifications 20

Notes 21-23

Warranty Back Cover

About the symbols for instructions

 Indicates hazards likely to cause harm to the unit itself or other material damage.

 Indicates special operating features of this unit.

 Indicates tips and hints for making a task easier.

Before Use

Safety Precautions

Handling the unit

When shipping the unit

The original shipping carton and packing materials come in handy. For maximum protection, re-pack the unit as it was originally packed at the factory.

To keep the surface clean

Do not use volatile liquids, such as insecticide spray, near the unit. Do not leave rubber or plastic products in contact with the unit for a long period of time. They will leave marks on the surface.

Cleaning the unit

To clean the cabinet

Use a soft, dry cloth. If the surfaces are extremely dirty, use a soft cloth lightly moistened with a mild detergent solution. Do not use strong solvents, such as alcohol, benzene, or thinner, as these might damage the surface of the unit.

Notes on Discs

Handling discs

Do not touch the playback side of the disc.
Hold the disc by the edges so that fingerprints will not get on the surface.
Do not stick paper or tape on the disc.

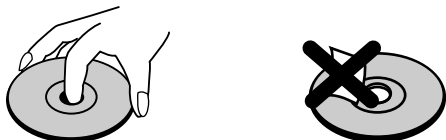

Storing discs

After playing, store the disc in its case.
Do not expose the disc to direct sunlight or sources of heat, or leave it in a parked car exposed to direct sunlight, as there may be a considerable temperature increase inside the car.

Cleaning discs

Fingerprints and dust on the disc can cause poor sound quality and sound distortion. Before playing, clean the disc with a clean cloth. Wipe the disc from the center out.

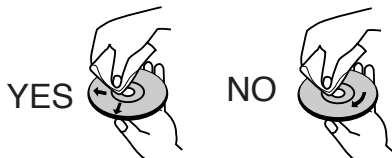

Do not use strong solvents such as alcohol, benzene, thinner, commercially available cleaners, or anti-static spray intended for analog records.

Notes on Remote Control

Remote control operating range

Point the remote control at the remote sensor and press the buttons.

- **Distance:** About 23 ft (7 m) from the front of the remote sensor.
- **Angle:** About 30° in each direction of the front of the remote sensor.

Remote control battery installation

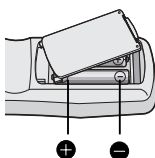

Detach the battery cover on the rear of the remote control, and insert two R03 (size AAA) batteries with \oplus and \ominus aligned correctly.

Caution

Do not mix old and new batteries. Never mix different types of batteries (standard, alkaline, etc.).

Notes on Tapes

Preventing overwriting a recording

Removing the safety tab(s) of the cassette (with a small screwdriver) will prevent accidental erasure.

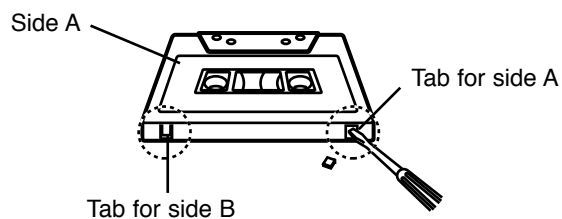

To record again, cover the hole of the tab with adhesive tape.

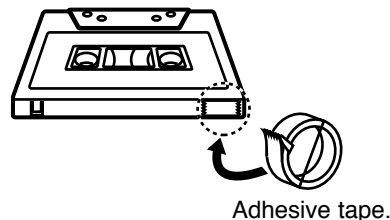

Front Panel/Rear Panel

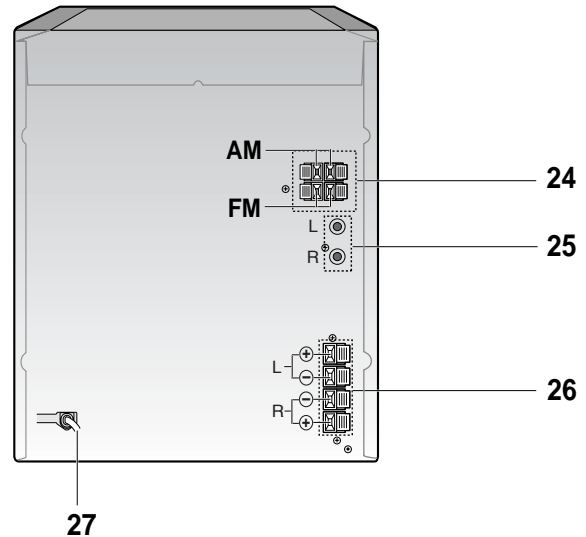
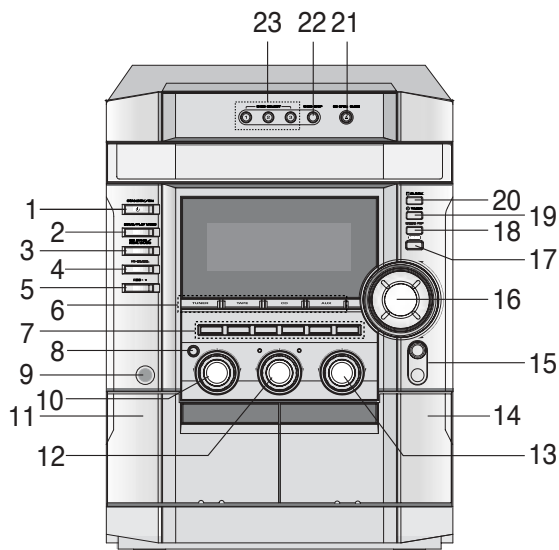

- | | |
|--|--|
| <ol style="list-style-type: none"> 1. POWER (STANDBY/ON) button 2. • PLAY MODE button
• DEMO button 3. • CD SYNC. button
• NORMAL DUBBING button 4. HIGH SPEED DUBBING button 5. RECORD/ RECORD PAUSE (● REC /) button 6. FUNCTION SELECT buttons
(TUNER, TAPE, CD, AUX) 7. • TUNING DOWN button
• PRESET DOWN button
• REWIND (◀◀) button
• REVERSE PLAY (◀) button
• STOP (■)/CLEAR button
• FORWARD PLAY (▶) button
• TUNING UP button
• PRESET UP button
• FAST FORWARD (▶▶) button
• CD PAUSE button
• SET (CLOCK/ TIMER) button
• COUNTER RESET button 8. • PROG. button
• MEMO. button
• ENTER button | <ol style="list-style-type: none"> 9. HEADPHONE JACK (PHONES): ∅6.3mm 10. EQUALIZER knob (EQ) 11. ▲ PUSH OPEN position - TAPE A (DECK A) 12. SURROUND ADJUST knob 13. MULTI JOG SHUTTLE 14. ▲ PUSH OPEN position - TAPE B (DECK B) 15. • MIC JACK (MIC): ∅6.3mm
• MIC VOLUME KNOB (MIC VOL.) 16. VOLUME DOWN/UP knob 17. XDSS button 18. MODE/RIF button 19. TIMER button 20. CLOCK button 21. CD OPEN/ CLOSE(CD▲) button 22. DISC SKIP button 23. DISC DIRECT PLAY buttons
(DISC1, DISC2, DISC3) |
|--|--|

- | |
|--|
| <ol style="list-style-type: none"> 24. ANTENNA TERMINAL 25. AUXILIARY INPUT JACK 26. SPEAKER TERMINAL 27. POWER CORD |
|--|

Remote Control

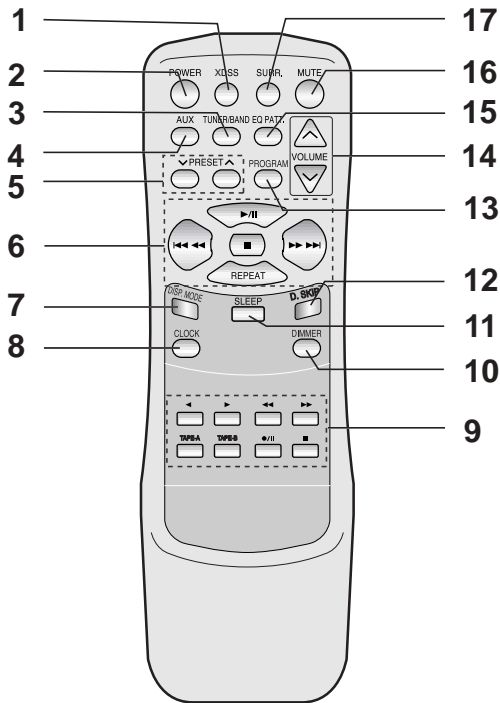

1. XDSS button
2. POWER button
3. TUNER/BAND button
4. AUX button
5. PRESET (∨/∧) button
6. CD FUNCTION buttons
 - PLAY/ PAUSE (▶/⏸) button
 - CD STOP (■) button
 - CD SKIP (◀◀/▶▶) button
 - FAST REWIND/ FAST FORWARD PLAY (◀◀◀/▶▶▶) button
 - REPEAT button
7. DISPLAY MODE button
8. CLOCK button
9. TAPE FUNCTION buttons
 - RECORD/ RECORD PAUSE (●/⏸) button
 - REVERSE PLAY (◀) button
 - FORWARD PLAY (▶) button
 - TAPE STOP button (■)
 - FAST FORWARD PLAY (▶▶) button
 - FAST REWIND PLAY (◀◀) button
 - TAPE-A/B SELECT button
10. DIMMER button
11. SLEEP button
12. DISC SKIP (D.SKIP) button
13. PROGRAM button
14. VOLUME CONTROL (∨/∧) button
15. EQUALIZER PATTERN (EQ PATT.) button
16. MUTE button
17. SURROUND (SURR.) button

Display Window

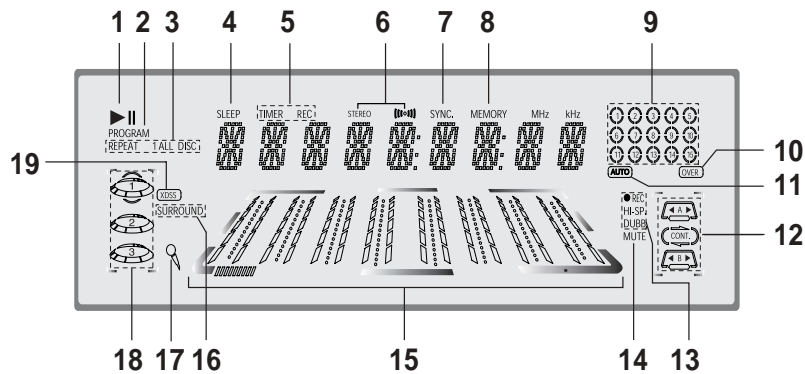

1. PLAY/ PAUSE indicator
2. PROGRAM indicator
3. REPEAT indicator
4. SLEEP indicator
5. TIMER indicator
6. FM STEREO RECEIVING indicator
7. CD SYNC. indicator
8. MEMORY indicator
9. CD TRACK indicator
10. CD TRACK OVER indicator
11. AUTO TUNE RECEIVING indicator
12. • PLAY MODE SELECT indicator
 - TAPE PLAY DIRECTION indicator
 - TAPE A/B SELECT indicator
13. • RECORD/RECORD PAUSE indicator
 - NORMAL DUBBING indicator
 - HIGH DUBBING indicator
14. MUTE indicator
15. LEVEL indicator
16. SURROUND indicator
17. MIC indicator
18. DISC Number indicator
19. XDSS indicator

Connections

Speaker System Connection

Connect the speakers using the supplied speaker cords by matching the colors of the terminals and those of the cords. To obtain the best possible surround sound, adjust the speaker parameters (distance, level, etc.).

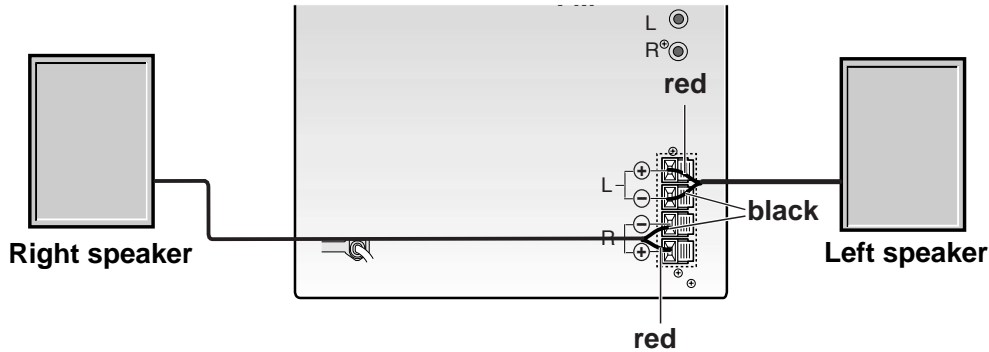

Notes

- Be sure to match the speaker cord to the appropriate terminal on the components: + to + and – to –. If the cords are reversed, the sound will be distorted and will lack base.
- If you use front speakers with a low maximum input rating, adjust the volume carefully to avoid excessive sound output to the speakers.
- Do not disassemble the front cover of supplied speaker.

Antenna (Aerial) Connections

Connect the supplied FM/AM antennas for listening to the radio.

- Connect the AM loop antenna to the AM antenna connector.
- Connect the FM wire antenna (or FM “T” antenna) to the FM 300Ω connector.

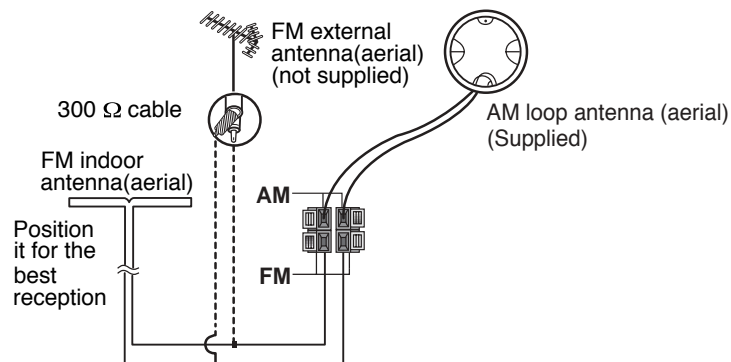

Notes

- To prevent noise pickup, keep the AM loop antenna away from the unit and other components.
- Be sure to fully extend the FM antenna wire.
- After connecting the FM antenna wire, keep it as horizontal as possible.

Setting the CLOCK

- 1** Press **CLOCK**.
(If the clock requires setting, press and hold **CLOCK** for more than 2 seconds.)
- The hours display begins to blink.
- 2** Select either the 24 hour cycle or the 12 hour cycle with the **MULTI JOG SHUTTLE**.

(12HR) or (24HR)
- 3** Press **SET** to confirm the selected hour cycle.
- 4** Use **MULTI JOG SHUTTLE** to set the current hour.
- 5** Press **SET**.
- 6** Use **MULTI JOG SHUTTLE** to set current minutes.
- 7** Press **SET** and the correct time is shown on the display.
- 8** Press **CLOCK** at any time to show the time on the display, for about 5 seconds.

Sleep Timer Function

When the sleep timer is set, the unit automatically turns off after the specified time has elapsed.

- 1** To specify the time delay before the power is turned off, press **SLEEP**.
In the display window you can see *SLEEP 90* for about 5 seconds. This means that the system turns off automatically after 90 minutes. Each time the button is pressed the time interval before it turns off is reduced by 10 minutes. i.e. 80...70... etc.
Select the desired time to turn off.
 - 2** To check the remaining time until the power is turned off.
While the sleep function is active press **SLEEP** briefly. The time remaining until the unit turns off is displayed for about 5 seconds.
- Note**
If you press **SLEEP** while the sleep time is displayed, the **SLEEP** time is reset.

To cancel Sleep Timer setting

If you wish to stop the function, press the **SLEEP** button repeatedly until 10 appears, and then press **SLEEP** once again after 10 shows on the display.

Using Microphone

You can sing along with a music source by connecting a microphone to the unit.

- 1** Connect your microphone (not supplied) to the **MIC** jack.
- 2** Play the song you want to sing along with.
- 3** Sing along with the accompaniment.
Adjust the microphone volume by turning **MIC VOLUME KNOB**.

For your reference

You can record using a microphone.
Refer to the "Recording" explanation section.

Notes

- When not using the microphone, set the **MIC** volume knob to minimum or turn off the **MIC** and remove the microphone from the **MIC** jack.
- If the microphone is set too near the speaker, a howling sound may be produced. In this case, move the microphone away from the speaker or decrease the sound level with the **MIC** volume control.
- If the sound through the microphone is extremely loud, it may be distorted. In this case, turn the **MIC** volume control toward minimum.

Timer Functions

Using the TIMER function you can have the radio reception and recording, CD play, tape play or auxiliary source play and recording turned on and off at the time desired.

- 1** Press **CLOCK** to check the current time.
- 2** Press **"TIMER"** to enter the timer setting mode. (If you want to correct the previous memorized TIMER setting, press and hold the **"TIMER"** button more than 2 seconds.)
The previous memorized timer setting for On Time and **"TIMER"** appear in the display. Each function: TUNER-CD-TAPE flash in the display window in turn.
- 3** Press **SET** when the desired function flashes.
- 4** If you select TUNER:
PLAY and REC flash in the display window alternately for about 3 seconds. Press **SET** to confirm the desired operating mode.
REC: TUNER recording and play
PLAY: TUNER play only
 - If you have selected CD or TAPE, ignore step 4.
- 5** If you have selected TUNER:
To correct a previously memorized preset number, use the **MULTI JOG SHUTTLE** and press **SET**.
The hour **"ON TIME"** display flashes.
 - If you have selected CD or TAPE, ignore step 5.
- 6** Set the turn on hour using the **MULTI JOG SHUTTLE**.
- 7** Press **SET** to confirm the turn on hour time.
The minute display flashes.
- 8** Set the turn on minutes time using the **MULTI JOG SHUTTLE**.
- 9** Press **SET** to confirm the turn on minutes time.
The hour 'OFF TIME' now flashes in the display.
- 10** Set the turn off hour time using the **MULTI JOG SHUTTLE**.
- 11** Press **SET**.
- 12** Set the turn off minutes using the **MULTI JOG SHUTTLE**.
- 13** Press **SET**.
- 14** Adjust the volume level using the **MULTI JOG SHUTTLE**.
- 15** Press **SET**.
"TIMER" appears in the display window and the timer setting has been completed.
- 16** Turn the system off.
The selected function is automatically switched on and off at the preset times.

To cancel or check the timer

Each time the **"TIMER"** button is pressed, you can select the timer set or cancel. You can also check the timer setting status.

To activate or check the timer, press the **"TIMER"** button repeatedly so that **"TIMER"** appears in the display window.

To cancel the TIMER, press the **"TIMER"** button repeatedly so that **"TIMER"** disappears from the display window.

Audio Adjustment

Volume Adjustment

- On unit, turn **VOLUME DOWN/UP knob** clockwise to increase the sound level, or counterclockwise to decrease it.
- On remote, use **VOLUME CONTROL (^)** to increase the sound level, or use the **VOLUME CONTROL (v)** to decrease sound.

Sound Quality Adjustment

- **To activate stereo sound**
 - You can choose between 8 fixed sound impressions and 1 USER MODE.
Select a desired sound mode using the **EQ PATT.** button (or turning EQ knob on the front panel).
 - When you select USER MODE, press the ENTER button repeatedly.
You can select three sound modes (BASS, MIDDLE, TREBLE).
 - Each time you press the button the indicator in the display window changes as follows.

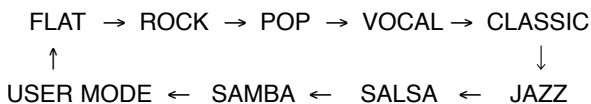

- **Headphone Jack**

Connect a stereo headphone plug (ø6.3mm) into the headphone jack.
The speakers are automatically disconnected when you plug in the headphones (not supplied).

MUTE

Press **MUTE** to turn off the sound, press again to restore.
You can mute your unit in order, for example, to answer a telephone, "MUTE" indicator flashes in the display window.

SURROUND

To activate surround mode

- You can choose between 6 fixed sound impressions.
- Select a desired surround mode using the **SURROUND** button.
- Each time you press SURROUND, the indicator changes as follows.

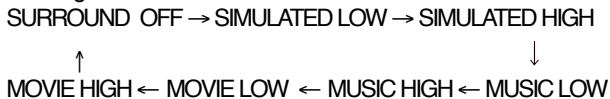

DISPLAY MODE

Whenever you press **DISPLAY MODE**, you can enjoy the spectrum change with 6 types in the display.

XDSS (Extreme Dynamic Sound System)

- Use the **XDSS** feature to reinforce treble, bass and surround effect.
- Each time you press XDSS the indicator changes as follows.

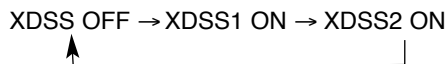

DEMO

Press **DEMO** with the power off to review the available functions in the display window.
To cancel DEMO, press **POWER** or **DEMO** again.
During demonstration with the power on, you can cancel DEMO by pressing any other button.

DIMMER

Dimmer darkens the display window by half with the power on. Press **DIMMER** once, and the display darkens. If you press Dimmer a second time, the display will darken by half again. To cancel, press Dimmer a third time.

Auxiliary (External Equipment) Input

- 1 Connect an auxiliary device i.e. TV or VCR, via the rear mounted AUX input jacks.
- 2 Press **AUX**.



Note
You can also record from the auxiliary input source, see Recording Section.

Presetting the Radio Stations (Channel Search)

You can preset 30 stations for FM and AM. Before tuning, make sure that you have turned the volume down to the minimum level.

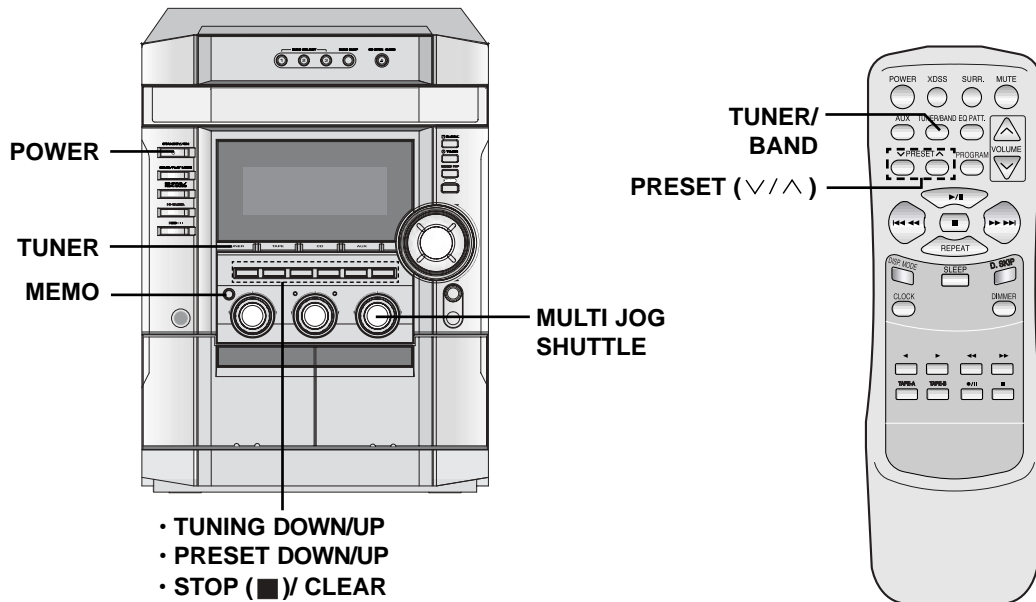

- 1** Press **POWER** to turn the unit on.
- 2** Press **TUNER** or **TUNER/BAND** to show either FM or AM in the display window.
- 3** Every time you press **TUNER** or **TUNER/BAND**, FM and AM change alternately.
- 4** Press **TUNING DOWN/UP** on the front panel until the frequency indicator starts to change, then release.
Scanning stops when the unit tunes in a station.
- 5** Press **MEMO** on the front panel.
A preset number will flash in the display window.
- 6** Press **PRESET DOWN/UP** (or **PRESET (∇/∧)** on the remote control) to select the preset number you want.
- 7** Press **MEMO** on the front panel again.
- The station is stored.
- 8** Repeat steps 3 to 6 to store other stations.

To tune in a station with a weak signal

Use the **MULTI JOG SHUTTLE** to tune in the station manually.

To clear all memorized stations

Press and hold **MEMO** on the front panel for about two seconds, "CLEAR" appears in the display window. Press **CLEAR** again, the stations are cleared.

For your reference

If all stations have already been entered, the **FULL** message will appear in the display window for a moment and then a preset number will flash. To change the preset number, follow the steps 6-7 on the left side.

To recall preset numbers

Press and hold **PRESET DOWN/UP** (or **PRESET (∇/∧)** on the remote control) until the desired preset number appears or press the button repeatedly.

Automatic Tuning

Use **TUNING DOWN/UP**.

Manual Tuning

Use the **MULTI JOG SHUTTLE**.

Listening to the Radio

Preset radio stations in the units memory first (see “Presetting the Radio Stations (Channel Search)” on the previous page).

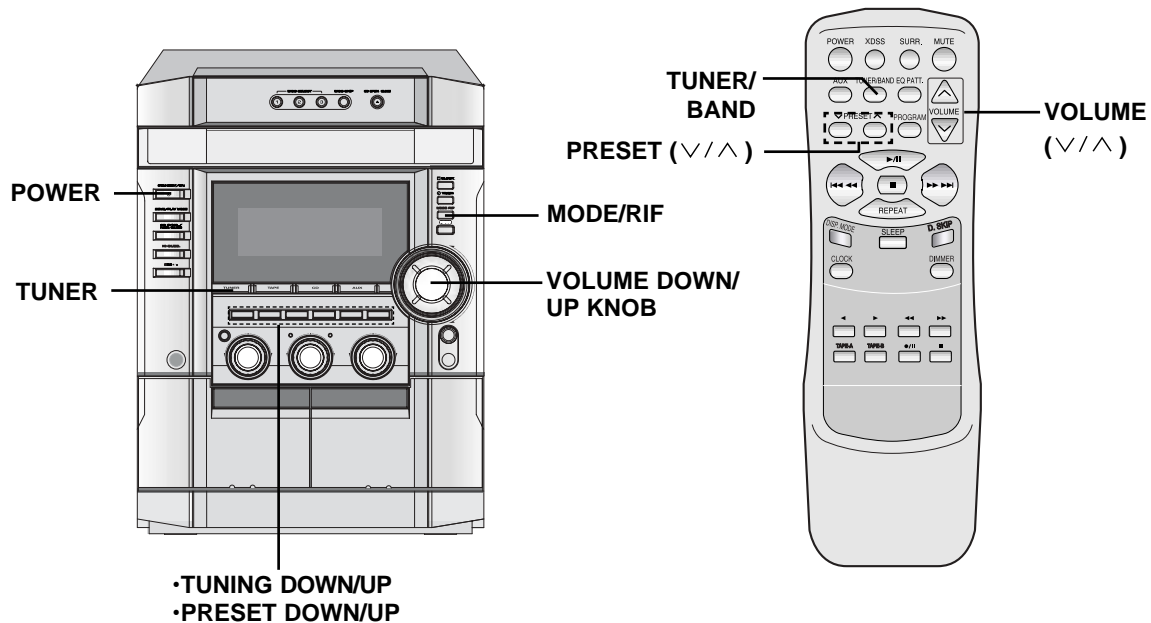

- 1** Use **TUNER** or **TUNER/BAND** to select either **AM** or **FM** in the display window. The last received station is tuned in.
- 2** Press **PRESET DOWN/UP** (or **PRESET ∇/∧** on the remote control) repeatedly to select the preset station you want. Each time you press the button, the unit tunes in the next preset station.
- 3** Adjust the volume by rotating **VOLUME DOWN/UP KNOB** (or pressing **VOLUME (∇/∧)** on the remote control) repeatedly.

To listen to non-preset radio stations

- For manual tuning, see “Manual Tuning” on the previous page.
- For automatic tuning, see “Automatic Tuning” on the previous page.

To turn the radio off

Press **POWER** to turn the unit off or select another function mode (CD, TAPE or AUX).

For your reference

- **If a FM program is noisy**
Press **MODE/RIF** repeatedly so that “STEREO” disappears in the display window. There will be no stereo effect, but the reception will improve. Press **MODE/RIF** again to restore the stereo effect.
- **To improve reception**
Reposition the supplied antennas.

Notes

- Use **MODE/RIF** (Radio Interference Filter) function to switch to Mono reception if stereo reception is distorted by noise.
- When recording weak AM broadcasts, if beat noises occur, press **MODE/RIF** once.

Tape Playback

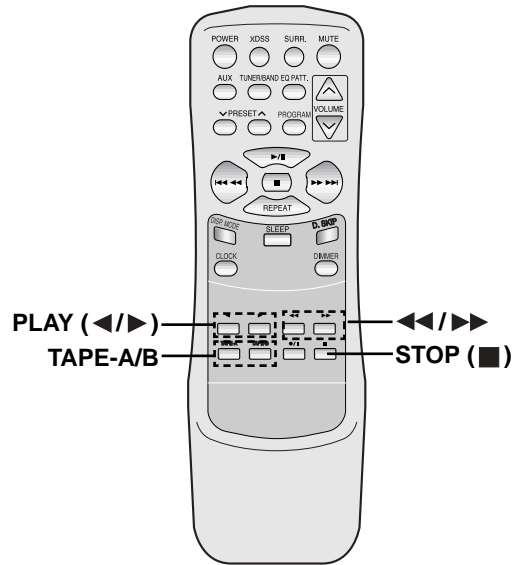
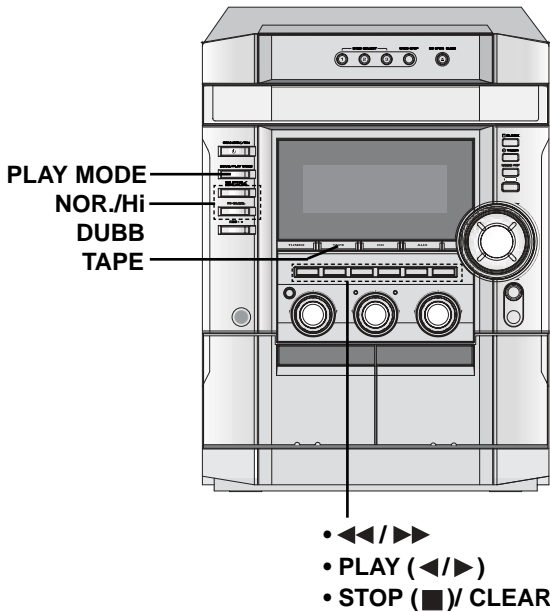

Basic Playback

- 1 Use TAPE or TAPE-A/B button to select TAPE A or TAPE B cassette deck.
(“NO TAPE” appears in the display window.)
- 2 Open cassette TAPE A (or B) door by pushing the PUSH OPEN button.
- 3 Insert one or two cassettes with the tape side to the bottom and then close the TAPE A (and/or B) door.
- 4 Press PLAY (or).

AUTO STOP DECK (TAPE A)

After Tape A deck plays front side of cassette, the unit stops automatically.

AUTO REVERSE DECK (TAPE A/B)

Select cassette playback direction (front or back) with PLAY MODE button.

Presses	Display	Function
One		After the cassette in deck TAPE B plays front or reverse (backward play) side, stops automatically.
Two		After the cassette in deck TAPE B plays front and reverse side, stops automatically.
Three		After the cassette in deck TAPE B plays six times repeatedly front and reverse side, stops automatically.

To Stop Play

Press STOP () during playback.

Tape Counter Reset

Press COUNTER during playback.

Playing time appears “TAP A (or B) 0000” in display window.

To Play Fast Rewind or Fast Forward

After pressing and holding on the front panel or on the remote control during playback, press PLAY () at the tape position you want.

Dubbing

How to copy from one tape to another.

- 1 Press TAPE or TAPE-A/ B.
 - Cassette TAPE A- Insert the playback tape to dub.
 - Cassette TAPE B- Insert a blank tape to copy on.
- 2 Press NOR./ Hi DUBB. as indicated below.

Press	Display	Function
NOR.- DUBBING	● REC DUBB.	Normal speed copying.
Hi- DUBBING	● REC HI-SP. DUBB.	Double speed copying.

To stop dubbing, press STOP().

Recording Setup

Wind the tape to the recording start point.
Only use normal tapes to make recordings.
You can only use deck B for recording.

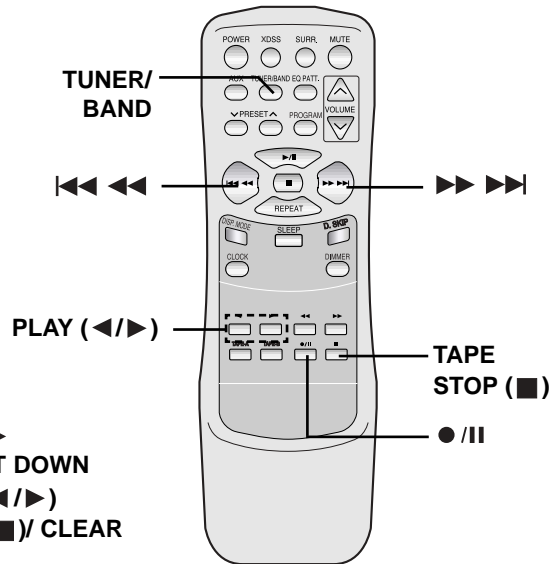
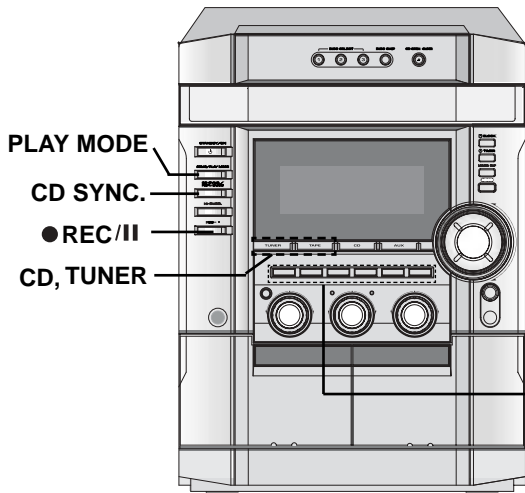

Basic Recording Setups

1 Press CD or TUNER/BAND to select source.

2 Open the cassette deck TAPE B and insert a blank cassette into the cassette compartment.

Set the recording direction

Press **PLAY MODE** repeatedly to set the recording direction.

Presses	Display	Function
One	→	Recording front side.
Two	→)	Recording front and reverse side.
Three	(←	

Recording from Radio, CD or Auxiliary source

1 Press **RECORD/ RECORD PAUSE (●REC/II or ●/II)** button .
“●REC” flashes and holds the cassette in pause mode.

2 Press **PLAY(▶)** on the front panel.
The recording begins.

To Pause Recording

To pause the recording, press **RECORD/ RECORD PAUSE (●REC/II or ●/II)** button again.
“●REC” flashes in display window.

To Stop Recording

Press **TAPE STOP (■)**.

CD to Tape Synchronized Recording

The CD synchro recording function dubs a complete CD and programmed titles automatically onto a cassette.

1 In Stop mode, press **CD SYNC..**
“●REC” flashes and “CD SYNC” appears in the display window.

2 The synchronized recording is started automatically after about 7 seconds.

Notes

- If you wish to record from the desired track, select the desired track with **|<<<</>>>>|** before commencing CD synchro recording.
- A function change is not possible during recording.

CD Playback (Continued)

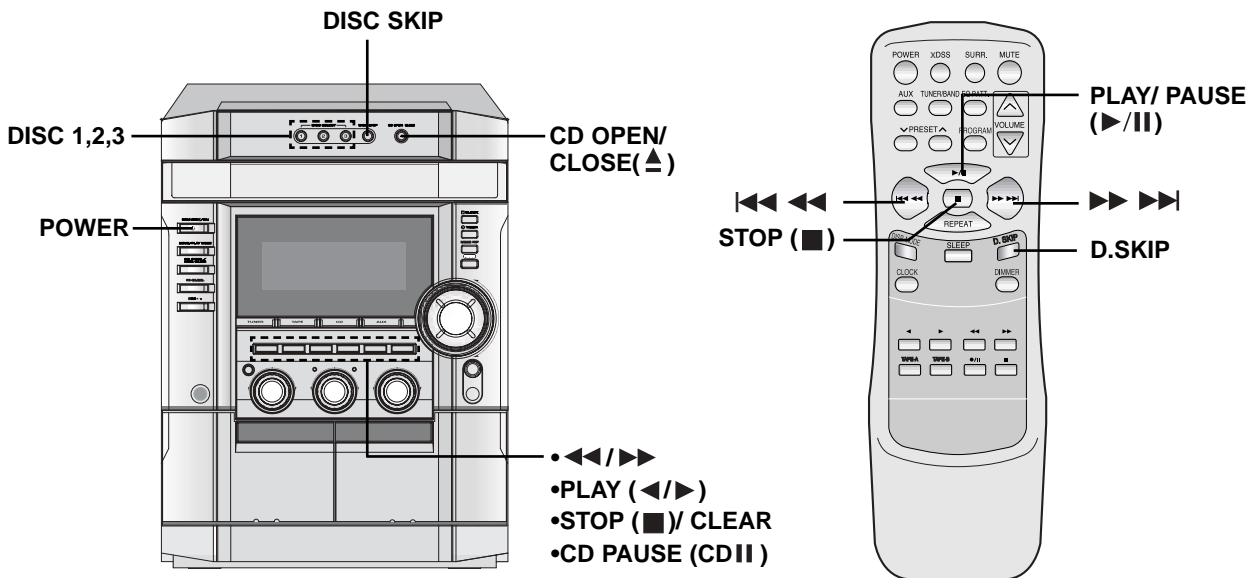

Basic Playback Setup

- 1** Press **POWER** to turn on the unit.
- 2** Press the **CD** button to enter the **CD** mode. If no disc is in the disc drawer, the "NO DISC" indicator appears.
- 3** Press **CD OPEN/CLOSE (▲)** and place the disc into the disc tray. The disc on the left (**DISC 1**) is played first.

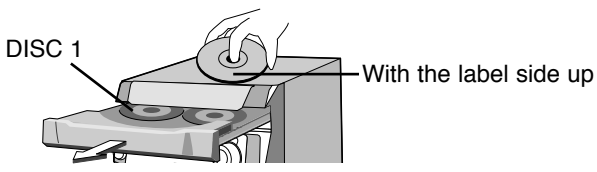

Note
To load an 8cm(3 inch) disc, put it onto the inner circle of the tray.

- 4** Press **CD OPEN/CLOSE (▲)** to close the disc compartment.
- 5** Press **PLAY (▶)** or **PLAY/ PAUSE (▶/||)** on the remote control.

To Pause Play

Press **CD PAUSE (CDII)** or **PLAY/ PAUSE (▶/||)** on the remote control during playback. Press the button again to resume play.

To Stop Play

Press **STOP (■)** during playback.

To Skip a Track

- Press **▶▶** on the front panel or **CD SKIP ▶▶ ▶▶** on the remote control to go to the next track.
- When **◀◀** button on the front panel or **CD SKIP ◀◀ ◀◀** button on the remote control is pressed once midway through a track, the player returns to the start of that track. When it is pressed again, a track is skipped each time the button is pressed.

To Fast Rewind or Fast Forward

After pressing and holding **◀◀/▶▶** on the front panel or **◀◀ ◀◀ / ▶▶ ▶▶** on the remote control during playback, press **PLAY (▶)** at the point you want.

To Go to the Next Disc

Press **DISC SKIP** or **D.SKIP** during playback or in **Stop** mode.

To Select a Disc Directly

Press **DISC 1**, **DISC 2** or **DISC 3** during playback or in **Stop** mode.

When you press **DISC 1-3** before playing a disc, the unit will automatically start playing the selected disc.

CD Playback (Continued)

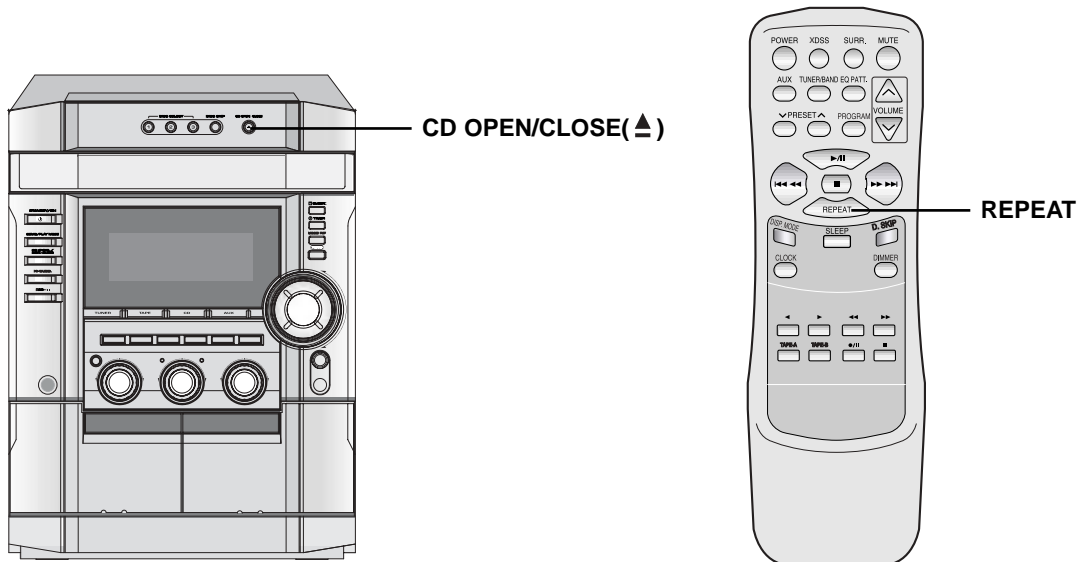

To Exchange Discs During Playback

You can open the disc tray while playing a disc to check what discs are to be played next and exchange discs, without interrupting playback of the current disc.

- 1 Press CD OPEN/CLOSE (▲).**
The disc tray is opened. Two disc compartments appear. Even if the unit is playing a disc, it doesn't stop playing.
- 2 Replace discs in the compartments with other ones.**
The unit plays the disc in the left compartment after the current disc, and then the one in the right compartment.
- 3 Press CD OPEN/CLOSE (▲).**
The CD door closes.

Notes

- Do not place more than one compact disc on one disc tray at the same time.
- Do not push on the disc tray to close CD door, you may damage the unit.

To Repeat Play

To play one track repeatedly.

Press **REPEAT** once during playback.
- "REPEAT 1" appears in the display window.

To play one disc repeatedly.

Press **REPEAT** again during playback.
- "REPEAT 1 DISC" appears in the display window.

To play all tracks on all discs repeatedly

Press **REPEAT** once more during playback.
- "REPEAT ALL DISC" appears in the display window.

To cancel repeat play

- Press **REPEAT** several times until repeat indicators disappear.

Program repeat play

- Press **REPEAT** once during program play.
 - "REPEAT 1" appears in the display window. (One track repeat)
- Press **REPEAT** again during program play.
 - "REPEAT ALL DISC" appears in the display window. (All program repeat)

CD Playback

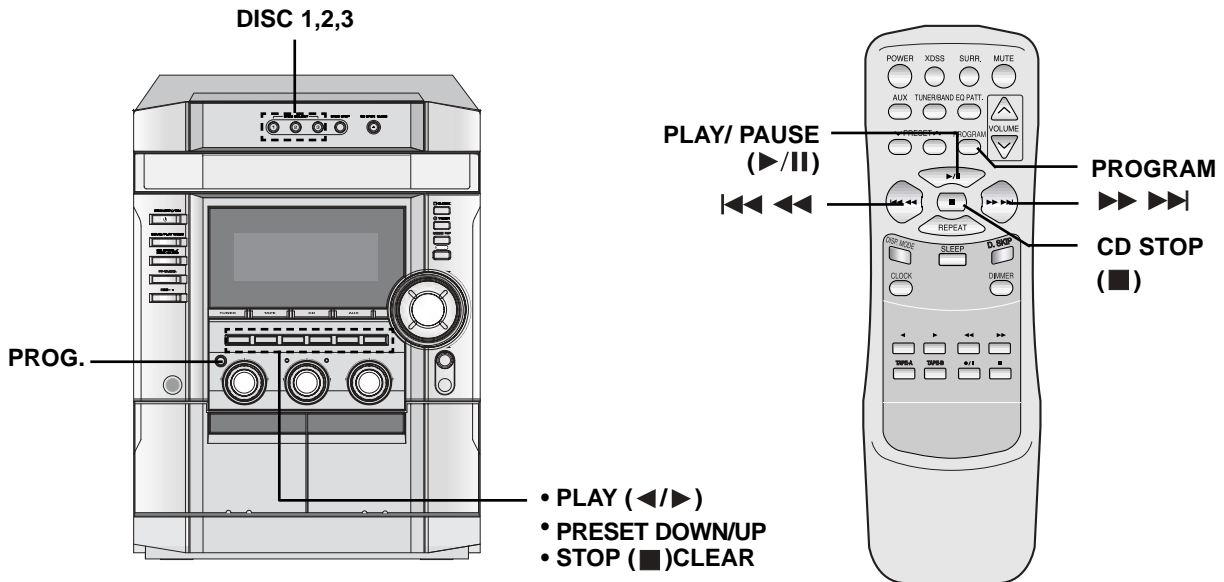

Program Play Setup

You can arrange the order of the tracks on the discs and create your own program. The program can contain up to 20 tracks.

- 1** Press **PROG.** (or **PROGRAM** on the remote control) in the Stop mode.
- 2** Press **D.SKIP** or **DISC DIRECT PLAY (DISC1/2/3)** to select the disc.
- 3** Use **PRESET DOWN/UP** or **MULTI JOG SHUTTLE** on the front panel or **CD SKIP** ◀◀◀◀ / ▶▶▶▶ on the remote control to select the track.
- 4** Press **PROG.** (or **PROGRAM** on the remote control).
- 5** Repeat steps 1~4 to select additional discs and tracks.
- 6** Press **PLAY(▶)** (or **PLAY/ PAUSE (▶/⏸)** on the remote control).

To check program contents

Press **PROG.** (or **PROGRAM** on the remote control) in Stop mode.

- The disc, track and program number will be displayed.

To clear program contents

Press **PROG.** (or **PROGRAM** on the remote control) in Stop mode. Then press **CLEAR** on the front panel or **CD STOP (■)** on the remote control.

To add program contents

1. Press **PROG.** (or **PROGRAM** on the remote control) repeatedly in the program Stop mode until "Disc Number" blinks.
2. Repeat steps 2~5 as shown to the left.

To modify program contents

1. Use **PROG.** (or **PROGRAM** on the remote control) to display program number you want to modify.
2. Repeat steps 2~4 as shown to the left.

Troubleshooting

Check the following guide for the possible cause of a problem before contacting service.

Symptom	Cause	Possible Solution
No power.	<ul style="list-style-type: none"> The power cord is disconnected. 	<ul style="list-style-type: none"> Plug the power cord into a wall power outlet securely.
No sound.	<ul style="list-style-type: none"> The audio cables are not connected securely. 	<ul style="list-style-type: none"> Insert the audio cables into the jacks securely.
	<ul style="list-style-type: none"> The external source equipment's power is switched off. 	<ul style="list-style-type: none"> Turn on the power of the external equipment connected with the audio cables.
	<ul style="list-style-type: none"> The Digital Audio Output is set to the wrong position. 	<ul style="list-style-type: none"> Set the Digital Audio Output to the correct position, then turn on the unit again by pressing POWER.
The unit does not start playback.	<ul style="list-style-type: none"> No disc is inserted. 	<ul style="list-style-type: none"> Insert a disc.
	<ul style="list-style-type: none"> An unplayable disc is inserted. 	<ul style="list-style-type: none"> Insert a playable disc.
	<ul style="list-style-type: none"> The disc is placed upside down. 	<ul style="list-style-type: none"> Place the disc with the playback side down.
	<ul style="list-style-type: none"> The disc is not placed within the guide. 	<ul style="list-style-type: none"> Place the disc on the disc tray correctly inside the guide.
	<ul style="list-style-type: none"> The disc is dirty. 	<ul style="list-style-type: none"> Clean the disc.
The remote control does not work properly.	<ul style="list-style-type: none"> The remote control is not pointed at the remote sensor on the unit. 	<ul style="list-style-type: none"> Point the remote control at the remote sensor on the unit.
	<ul style="list-style-type: none"> The remote control is too far from the unit. 	<ul style="list-style-type: none"> Operate the remote control within about 23 ft (7 m).
	<ul style="list-style-type: none"> There is an obstacle in the path of the remote control and the unit. 	<ul style="list-style-type: none"> Remove the obstacle.
	<ul style="list-style-type: none"> The batteries in the remote control are exhausted. 	<ul style="list-style-type: none"> Replace the batteries with new ones.

Specifications

General	Power Supply	AC 120V, 60Hz	
	Power Consumption	190W	
	Weight (Approx.)	23 pounds	
	External Dimensions (Approx.)	11 x 14.5 x 15.7 inches (W x H x D)	
CD	Frequency response	40 - 18000 Hz	
	Signal-to-Noise Ratio	70 dB	
	Dynamic range	70 dB	
Tuner	FM	Tuning Range	87.5 - 108.0 MHz
		Intermediate Frequency	10.7 MHz
		Signal-to-Noise Ratio	61/58 dB
		Frequency Response	60 - 10000 Hz
	AM (MW)	Tuning Range	530 - 1720 kHz
		Intermediate Frequency	450 kHz
		Signal-to-Noise Ratio	35 dB
		Frequency Response	100 - 1900 Hz
Amp	Output Power	200W + 200W	
	T.H.D	0.15%	
	Frequency Response	25 - 25000 Hz	
	Signal-to-Noise Ratio	80 dB	
TAPE	Tape Speed	4.75cm/sec	
	Wow Flutter	0.25% (MTT -111, JIS-WTD)	
	F.F/REW Time	120sec (C-60)	
	Frequency Response	125 - 8000Hz	
	Signal-to-Noise Ratio	43dB	
	Channel Separation	50dB(P/B)/45dB(R/P)	
	Erase Ratio	55dB (MTT-5511)	
Speakers	Model Number	FE-986E	
	Type	3Way 3Speaker	
	Impedance	6Ω	
	Frequency Response	45-20000Hz	
	Sound Pressure Level	85 dB/W (1m)	
	Rated Input Power	200W	
	Max. Input Power	400W	
	Net Dimensions (Approx.)	11 x 16.3 x 12.5 inches (W x H x D)	
Net Weight (Approx.)	17 pounds		

* Note: Design and specifications are subject to change without notice.

Notes

Notes

Notes

ZENITH ELECTRONICS CORPORATION
Compact Disc Player System with Speakers LMG340
LIMITED WARRANTY – USA

Zenith will repair or replace your product, at Zenith's option, if it proves to be defective in material or workmanship under normal use, during the warranty period ("Warranty Period") listed below, effective from the date ("Date of Purchase") of original purchase of the product. This limited warranty is good only to the original purchaser of the product and effective only when used in the United States, excluding U.S. Territories.

<p>WARRANTY PERIOD:</p> <p>LABOR: 90 days from the Date of Purchase.</p> <p>PARTS: 1 Year from the Date of Purchase.</p> <p>* Parts replaced are warranted for the remaining portion of the original warranty period.</p>	<p>HOW SERVICE IS HANDLED:</p> <p>Carry-In Service: Please retain dealer's dated bill of sale or delivery ticket as evidence of the Date of Purchase for proof of warranty, and submit a copy of the bill of sale to the service person at the time warranty service is provided.</p> <p>Please call 1-877-9Zenith (1-877-993-6484) to locate your nearest Zenith Authorized Service Center.</p> <p>Or visit our website at http://www.zenithservice.com</p>
--	--

THIS WARRANTY IS IN LIEU OF ANY OTHER WARRANTY, EXPRESS OR IMPLIED, INCLUDING WITHOUT LIMITATION, ANY WARRANTY OF MERCHANTABILITY OR FITNESS FOR A PARTICULAR PURPOSE. TO THE EXTENT ANY IMPLIED WARRANTY IS REQUIRED BY LAW, IT IS LIMITED IN DURATION TO THE EXPRESS WARRANTY PERIOD ABOVE. ZENITH WILL NOT BE LIABLE FOR ANY INCIDENTAL, CONSEQUENTIAL, INDIRECT, SPECIAL, OR PUNATIVE DAMAGES OF ANY NATURE, EVEN IF ADVISED OF THE POSSIBILITY OF SUCH DAMAGES, INCLUDING WITHOUT LIMITATION, LOST REVENUES OR PROFITS, LOST OR CORRUPTED PROGRAMMING OR DATA, OR ANY OTHER DAMAGE WHETHER BASED IN CONTRACT, TORT, OR OTHERWISE.

Some states do not allow the exclusion or limitation of incidental or consequential damages or limitations on how long an implied warranty lasts, so the above exclusion or limitation may not apply to you. This warranty gives you specific legal rights and you may also have other rights that vary from state to state.

THIS LIMITED WARRANTY DOES NOT APPLY TO:

- Damage caused in shipping or transit
- Service required as a result of improper installation, including incorrect or insufficient AC supply (Please consult the owner's manual for power supply requirements)
- Installation or repair of other components in a video system
- Set-up or adjustment on consumer controls, or damage caused by improper adjustments
- Damage cause by other system components
- Damage (including cosmetic damage), failure, loss or personal injury due to misuse, abuse, negligence, improper maintenance or storage, or to acts of nature or other causes beyond Zenith's control (Causes beyond Zenith's control include but are not limited to lightning strike, power surges, power outages, and water damage)
- Repair or replacement of warranted parts by other than Zenith Authorized Service Centers
- Units purchased or serviced outside the coverage area
- Product where the original factory serial numbers have been removed, defaced, or changed in any way
- Product sold and labeled as "as is, where is" or similar disclaimer

The costs of repair or replacement under these excluded circumstances shall be borne by the consumer.

CUSTOMER INTER-ACTIVE CENTER NUMBERS:

<p>For nearest Authorized Service Center, Where to buy, Product Assistance, or Customer Assistance</p>	<p>Call 1-877-9Zenith (1-877-993-6484) (Monday ~ Friday, 7 AM ~ 8 PM CT; and Saturday, 8 AM ~ 5 PM CT) and select appropriate option from the menu.</p> <p>Or visit our website at http://www.zenithservice.com</p>
---	---

ZENITH ELECTRONICS CORPORATION
 2000 MILLBROOK DRIVE
 LINCOLNSHIRE, IL 60069

Zenith Part No. 206-3875
 GS# 3828R-A074D
 Printed in China
 Issue O