

Ocean Controls KTA-223 Arduino Compatible USB Relay Controller

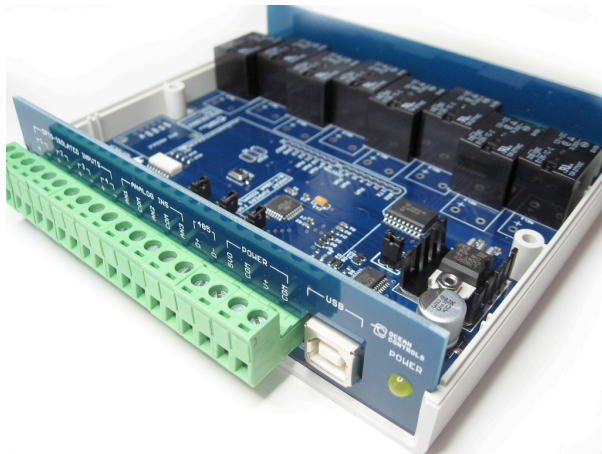

- 8 Relay Outputs 5A 250VAC
- 4 Opto-Isolated Inputs 5-30VDC
- 3 Analog Inputs (10 bit)
- Connections via Pluggable Screw Terminals
- 0-5V or 0-20mA Analog Inputs, Jumper Selectable
- 5A Relay Switching
- Power Indicator LED
- All enclosed in Professional looking plastic case
- Arduino Compatible
- Accepts Arduino Shields (Ethernet / XBEE)
- USB Virtual COM or RS485 Input
- Easily connect multiple units far apart by RS485

The KTA-223 is a USB or RS485 controlled IO module for interfacing PCs to real world applications, such as controlling lights and sprinkler systems, reading sensors and monitoring switches and other digital signals. The Relays are capable of switching up to 5A at 250VAC, 10A at 120VAC and 10A at 24VDC but the PCB tracks will only handle up to about 5A. A simple ASCII protocol allows control from Windows/Mac/Linux using either USB Virtual COM drivers or RS485. Additionally, multiple devices can be connected to one RS485 bus, allowing control of many devices from one USB port.

The controller is based on the hardware of the Arduino physical computing controllers. It can be programmed as a stand-alone controller using the free, open source Arduino environment. Internally, the controller is “shield-compatible”, allowing the use of many extension boards designed for the Arduino Deumilanove. As shipped the controller is loaded with a sketch that receives simple commands over the USB or RS485 serial port and switches relays or responds with the status of inputs. This sketch is available on the Ocean Controls website as an example of Arduino programming for the controller.

Multiple controllers can be connected to one or more PCs in an RS485 network. Each controller can be assigned an address and will respond to commands addressed to them.

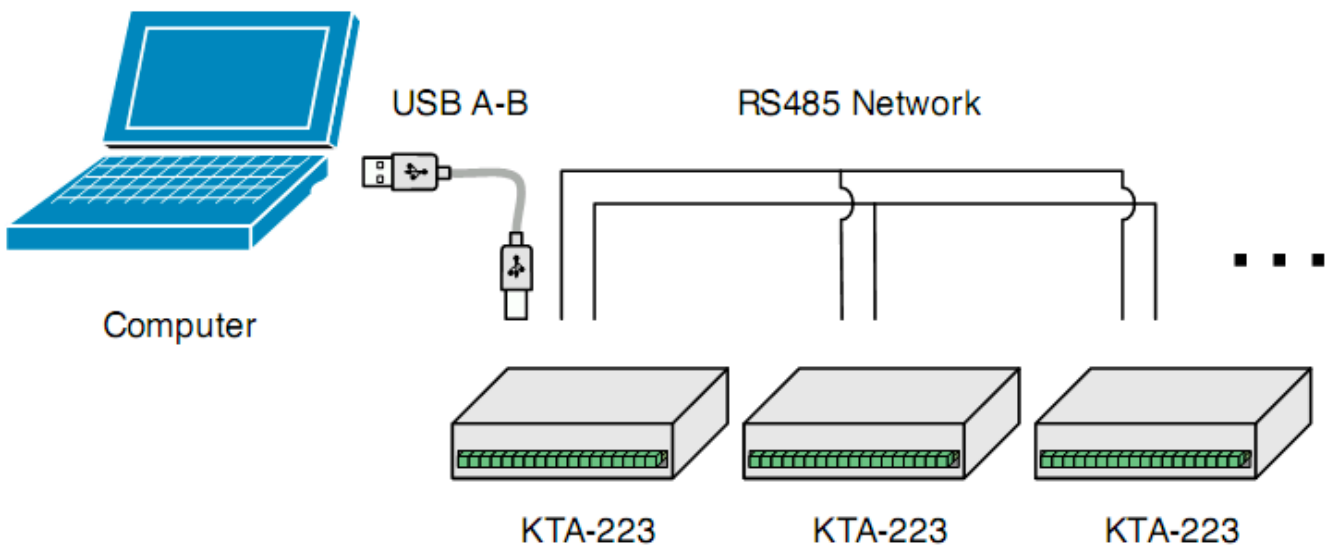

Figure 1 - Connecting multiple controllers with a RS485 network

Connections

Table 1 - Connections

Label	Description	Label	Description
+	Opto-Isolated Input Positive	5VO	5V Output for Sensors
-	Opto-Isolated Input Negative	V+	12V Power Supply Positive Input
ANx	Analog Input x	COM	Common Connection (Ground)
COM	Common Connection (Ground)	USB	USB B-type connection to PC
D+	RS485 Data+	NO	Relay Normally Open Contact
D-	RS485 Data-	C	Relay Common Contact
		NC	Relay Normally Closed Contact

Specifications

Power Supply V+ and COM:

KTA-223: 9-16V DC (12V Nominal) ~200mA + External 5V drain

KTB-223: 18-32V DC (24V Nominal) ~200mA + External 5V drain

Analog Input ANx:

0-5V: ~500kΩ effective resistance with no jumper installed

0-20mA: ~250Ω effective resistance with jumper installed

Opto-Isolated Input: 0-30V, ~1kΩ effective resistance

Relay Outputs: SPDT relays rated to 5A (resistive). 250VAC / 30VDC

5V Auxiliary Supply 5V: 200mA

Jumper Settings

The Analog inputs of the KTA-223 can be set for 0-5V or 0-20mA operation. Opening the case and inserting jumper shunts in the positions J1, J2 or J3 will set the associated analog inputs to 0-20mA operation. Removing the shunts will set the analog inputs to 0-5V operation.

The Analog inputs are protected with 4.7kΩ inline resistors, this will protect the microcontroller from damage for accidental input voltages up to 30V.

When the jumper labeled AUTO RESET is installed the board will reset each time a serial connection is made to the USB COM port. This should only be installed when reprogramming via the Arduino Environment, or the device will reset each time a serial connection is made to the unit.

Using the Controller

The controller requires 12VDC or 24VDC to operate, connected to V+ and COM. This can come from a plug-pack, bench top power supply or battery. The controller has screw terminals for the connection of power. Plug-pack power supplies often come with a plug on the end of the lead. The plug can be cut off and bare wires exposed for the screw terminals on the controller.

Connect the power supply positive connects to the V+ terminal and negative to the COM terminal next to it. The POWER LED should light. A diode protects the controller and prevents it from operating with power connected in reverse polarity. If the LED does not light, ensure your supply is delivering sufficient voltage and is connected correctly.

Connect the controller to a computer using a USB A male to USB B male cable. When the power is turned on your computer may prompt you to install drivers. The drivers required are the FTDI Virtual COM Port Drivers the latest versions for all systems are available from <http://www.ftdichip.com/Drivers/VCP.htm>

Test Utility

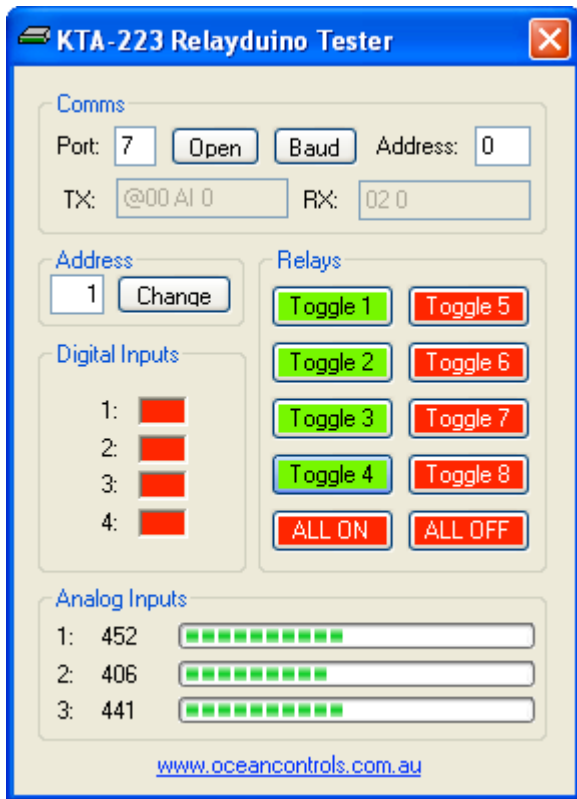

Figure 2 - Windows Test Utility

The main window of the Windows test utility is shown here.

If the Address of the unit you wish to control is known put it in the "Address" text box, if not, use 0 for the address and any unit will respond.

Enter the COM Port number in the "Port" text box, if this is not known it can be found in the device manager under ports. The quickest way to run device manager is by clicking Start->Run and then typing "devmgmt.msc".

Once the device is communicating, Relays can be turned on or off by clicking the buttons in the Relays group and the status of the Digital and Analog Inputs are shown in their relevant groups.

The source code for this program is available from Ocean Controls and is written in Visual Basic Express 2008 which is available free from Microsoft.

Ocean Controls can also supply a similar example program with source code for Visual Basic 6.

Communicating with the Controller

The Address and Baud Rate of the unit can be set and are stored in the controller's memory. By default the controller is listening for serial data at 9600 baud, and has address 00. The controller will always use 1 Stop Bit, 8 Data Bits and No Parity.

The commands the controller uses are in the form

```
@AA CC X<CR>
```

The @ symbol is used to define the start of a command.

AA is the address of the unit from 00 to 99.

CC is a two letter command used to determine the command type.

X is a one or more characters which determines the parameter for the command.

<CR> is the carriage return character. This is ASCII character 13, or 0x0d.

Each time a valid command is received the unit will respond with #AA followed by any values that are requested from the unit.

Note that 00 is the Wildcard Address, if a command has 00 as the address, all devices will respond as if they have been individually addressed.

Table 2 - Command set

Letter	Command	Parameters										
ON	Turn Relay On	1-8: Turn Relay 1-8 On Individually 0: Turn All Relays On at Once										
OF	Turn Relay Off	1-8: Turn Relay 1-8 Off Individually 0: Turn All Relays Off at Once										
WR	Write to all Relays at once	The parameter is a number which determines which of the relays should be turned on or off.										
RS	Status of Relays	1-8: Returns Status of Relays 1-8 Individually 0: Returns Status of All Relays										
IS	Status of Inputs	1-4: Returns Status of Inputs 1-4 Individually 0: Returns Status of All Inputs										
AI	Read Analog Input	1-3: Read Value of Analog Input 1, 2 or 3 0: Returns Value of All Analog Inputs										
SA	Set Address	01-99: Sets the Address of the unit in Memory										
SB	Set Baud Rate	1-10: Sets the Baud Rate <table border="1" style="margin-left: 20px;"> <tr> <td>1: 1200 baud</td> <td>6: 19200 baud</td> </tr> <tr> <td>2: 2400 baud</td> <td>7: 28800 baud</td> </tr> <tr> <td>3: 4800 baud</td> <td>8: 38400 baud</td> </tr> <tr> <td>4: 9600 baud (default)</td> <td>9: 57600 baud</td> </tr> <tr> <td>5: 14400 baud</td> <td>10: 115200 baud</td> </tr> </table>	1: 1200 baud	6: 19200 baud	2: 2400 baud	7: 28800 baud	3: 4800 baud	8: 38400 baud	4: 9600 baud (default)	9: 57600 baud	5: 14400 baud	10: 115200 baud
1: 1200 baud	6: 19200 baud											
2: 2400 baud	7: 28800 baud											
3: 4800 baud	8: 38400 baud											
4: 9600 baud (default)	9: 57600 baud											
5: 14400 baud	10: 115200 baud											

ON: Relay On Command

This command is used to turn a single relay on. E.g.: @44 ON 1 will turn relay 1 on for the unit with address 44. It can also be used to turn all the relays on, this occurs when the parameter value is 0.

OF: Relay Off Command

Similar to the on command this command will turn relays off in the same manner. E.g.: @44 OF 1 will turn relay 1 off for the unit with address 44, @44 OF 0 will turn all relays off.

WR: Write Relays Command

The write relays command is used when more than one relay is to be turned on or off at once. The parameter is a decimal number which, in binary, represents the on and off status of the 8 relays. The least significant bit of this value controls relay 1. The most significant bit of the parameter value controls relay 8. A set bit (1) turns the relay on, a cleared bit (0) turns the relay off.

Example: To turn relays 1, 2 and 6 on (and others off) the binary value required is 00100011. In decimal this is 35. $(2^{(1-1)} + 2^{(2-1)} + 2^{(6-1)} = 35)$. To issue this to a controller with address 44, the required command is @44 WR 35

IS: Input Status Command

This command will return the status of the inputs. If the parameter is between 1 and 4 then the controller will return a 0 or 1 corresponding to that input. E.g.: @44 IS 1 will return #44 1 if the input is on, or #44 0 if the input is off.

If the parameter is 0 then the unit will respond with the status of all the inputs, in similar form as the Write Relays command. E.g.: If inputs 1 and 2 for the unit are on then @44 IS 0 will return #44 3. 3 is 0011 in binary, and each bit represents each input from 4 down to 1.

RS: Relay Status Command:

Much the same as the input status command, this command will return the status of the relays. If the parameter is between 1 and 8 then the unit will return with a 0 or 1 corresponding to that relay. E.g.: @44 RS 1 will return #44 1 if the relay is on, or #44 0 if the relay is off.

If the parameter to this command is 0 then the unit will respond the same way as the input status command, but return the status of the relays.

AI: Analog Input Command

The analog input command will read the status of the analog input defined by the parameter and return it as a value between 0 and 1023. E.g.: @44 AI 1 will return #44 512 if the analog input is reading 50%.

SA: Set Address

Addresses are valid from 01-99. A unit will only respond if its address in memory is the same as that of the command sent, or if the address of the command sent is 00. The address is saved to non-volatile memory inside the controller, meaning it will be preserved even after power is disconnect from the controller.

SB: Set Baud

Parameters from 1 to 10 are valid, corresponding to values shown in Table 3.

Table 3 - Baud rate selection

1: 1200 baud	6: 19200 baud
2: 2400 baud	7: 28800 baud
3: 4800 baud	8: 38400 baud
4: 9600 baud (default)	9: 57600 baud
5: 14400 baud	10: 115200 baud

The baud rate is saved to non-volatile memory inside the controller, meaning it will be preserved even after power is disconnect from the controller.

Using the Controller as an Arduino

The KTA-223, as supplied, is an Arduino compatible board with Arduino bootloader and a custom sketch loaded that responds to the serial commands listed above. The source code of this is available from Ocean Controls and can be modified in the Arduino environment to suit your purpose.

The Arduino programming environment can be downloaded for Windows, Mac OS X and Linux from <http://www.arduino.cc/>

When using the KTA-223 with the Arduino Environment select “Arduino Duemilenove w/ ATmega328” from the “Tools->Board” menu, and install the “AUTO RESET” jumper on the PCB for ease of programming.

The hardware has been designed to accept the Arduino compatible Shields. The cover may not be able to be installed when using larger shields. Some shields may require removal or modification of the back panel to fit over-hanging components (The Libelium XBee shield fits with XBee modules using chip antennae, but SMA antenna connections conflict with the back panel)

The V1 controller PCB does not locate the 6-pin ICSP in the same position as the Arduino Deumillanove. Some shields (notably the Libelium XBee shield) take 5V power, ground or other signals from the ICSP header. These shields must be supplied power or signals from the standard Arduino header rows, or extended from the ICSP connection on the controller the the shield.

The the Libelium XBee shield must be supplied with 5V power by connecting 5V on the shield to K6 Pin 2 and GND on the shield to K6 Pin 6.

Space is provided on the PCB to install the SparkFun Real Time Clock module (SparkFun SKU: BOB-00099). The intention is to allow the controller to operate in stand alone situations that require more timing flexibility than the stock controller can provide. The PCB connects the RTC module SDA to Arduino Digital 12 and SCL to Arduino Digital 13. Installing this unit may prevent proper operation of other modules or shield that rely on these pins (for example, the Ethernet shield cannot be used with the RTC module.)

The RS485 transceiver is connected in parallel with the FTDI USB to Serial converter and ATmega328 UART pins. This transceiver allows half-duplex serial communication over 2 or 3 wires. The transceiver requires a TX Control

signal to enable the transmit or receive line driver. When transmitting, the TX Control line must be asserted (driven high). To receive, the line must be left low.

The FT232RL USB to Serial converter provides a TXEN signal for RS485 Transceivers. When data is received from the USB port by the FT232RL, it asserts the TX Control line, putting the RS485 transceiver in Transmit mode. The serial data is then transmitted to the ATmega328 and onto the RS485 network.

Using the RS485 transceiver from custom Arduino code requires that your code drive the TX Control line high at the beginning of data transmission and returns it low at the end of the transmission. The TX Control line is connected to Digital 19. The Ocean Controls sketch provides an example of how to do this.

Table 4 shows the mapping of Arduino pins to the inputs and outputs of the controller.

Table 4 - Arduino Pin Mapping

KTA-223 IO	Arduino Pin	AVR Port.Pin
Relay 1	Digital 2	PORTD.2
Relay 2	Digital 3	PORTD.3
Relay 3	Digital 4	PORTD.4
Relay 4	Digital 5	PORTD.5
Relay 5	Digital 6	PORTD.6
Relay 6	Digital 7	PORTD.7
Relay 7	Digital 8	PORTB.0
Relay 8	Digital 9	PORTB.1
Opto-In 1	Digital 15 / Analog 1	PORTC.1
Opto-In 2	Digital 16 / Analog 2	PORTC.2
Opto-In 3	Digital 17 / Analog 3	PORTC.3
Opto-In 4	Digital 18 / Analog 4	PORTC.4
Analog In 1	Analog 6	ADC6
Analog In 2	Analog 7	ADC7
Analog In 3	Analog 0	PORTC.0
RX Data	Digital 0	PORTD.0
TX Data	Digital 1	PORTD.1
RS485 TX Control	Digital 19 / Analog 5	PORTC.5
Ethernet Shield	Digital 10	PORTB.2
Ethernet Shield	Digital 11	PORTB.3
Ethernet Shield / RTC SDA	Digital 12	PORTB.4
Ethernet Shield / RTC SCL	Digital 13	PORTB.5

Wiring Examples: Inputs

The opto-isolated inputs allow for a range of connection possibilities. The figures below show the wiring for a dry-contact switch, NPN and PNP-type sensor.

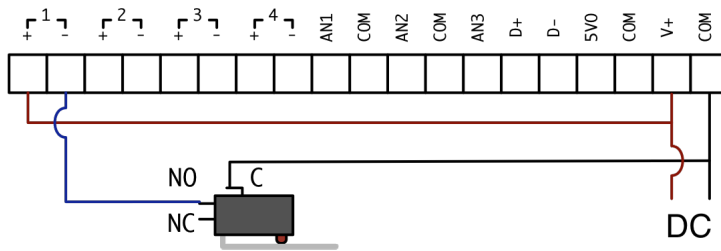

Figure 3 - Wiring a dry contact switch

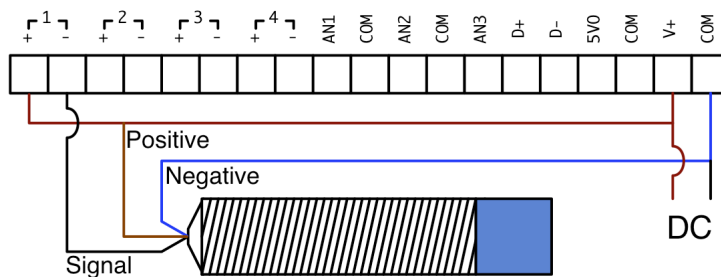

Figure 4 - Wiring an NPN-type sensor

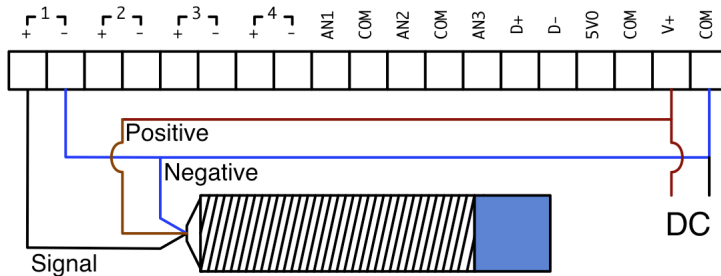

Figure 5 - Wiring a PNP-type sensor

Analog inputs can be wired for 0-5V or 0-20mA signals, depending on the position of the input jumper inside the unit. A regulated 5V output is provided for the convenience of wiring analog sensors like potentiometers.

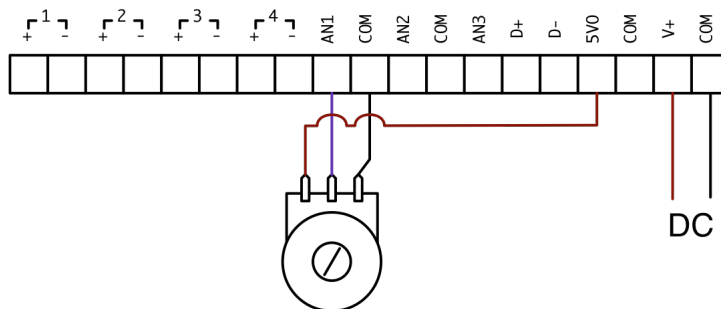

Figure 6 - Wiring a potentiometer

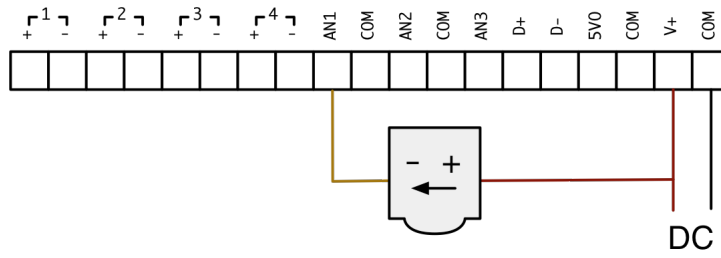

Figure 7 - Wiring a 4-20mA, loop-powered sensor

Wiring Examples: Outputs

The relay outputs on the KTA-223 can be wired to DC or AC loads.

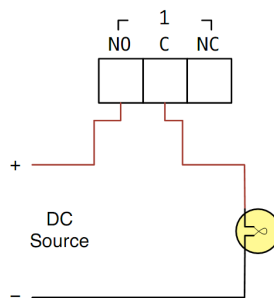
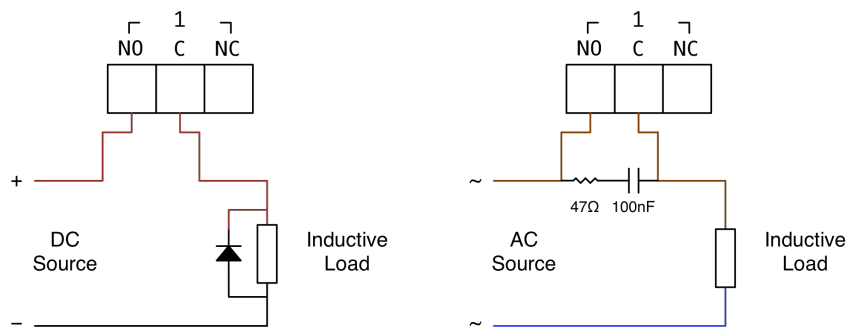

Figure 8 - Wiring a basic DC load

Inductive loads at high currents cause large voltage spikes when turned on or off, and this can disrupt sensitive electronics. For large inductive loads, a snubber is recommended. A DC load can be bypassed with a circulation diode. An AC load requires an RC snubber across the relay contacts. Ensure that diodes, resistors and capacitors used for snubbers are correctly rated for the load and voltage being switched.



Errata

The V1 PCB requires a link to be installed from R8 (pad furthest from MAX48) to the via closest to MAX485 Pin 5. This will have been installed by Ocean Controls on boards purchased through them or a distributor.

Selection Guide

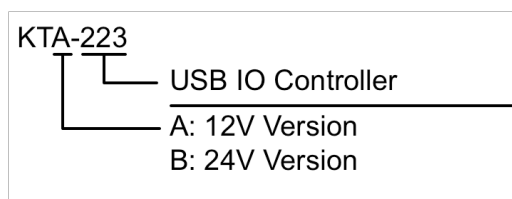

Licensing

The KTA-223 is derived from the Arduino Deumilanove and the schematics and CAD files are available under Creative Commons Attribution Share-Alike licenses. Contact info@oceancontrols.com.au for more information.