

English

**HVRM-T1600M / T800M / T400M,  
T1600Q / T800Q**

**Install & User's Guide**  
(v 1.0)



# Introduction

Thank you for purchasing a Hunt digital video recorder.

This manual is for **HVRM-T1600Q, HVRM-T800Q, HVRM-T1600M, HVRM-T800M, HVRM-T400M**. Before product installation and operation, please become thoroughly familiar with this user manual and other manuals referenced by this manual.

This user manual and the software and hardware described here are protected by copyright law. With the exception of copying for general use within fair use, copying and reprinting the user manual, either partially or in entirety, or translating it into another language without the consent of Hunt Inc. is strictly prohibited.

This specification may change without prior notice for improvement of product performance.

## Product Warranty and Limits of Responsibility

The manufacturer does not assume any responsibility concerning the sale of this product and does not delegate any right to any third party to take any responsibility on its behalf. The product warranty does not cover cases of accidents, negligence, alteration, misuse or abuse. No warranty is offered for any attachments or parts not supplied by the manufacturer.

- ❖ Malfunctions due to negligence by the user
- ❖ Deliberate disassembly and replacement by the user
- ❖ Connection of a power source other than a properly rated power source
- ❖ Malfunctions caused by natural disasters (fire, flood, tidal wave, etc.)
- ❖ Replacement of expendable parts (HDD, FAN, etc.)
- ※ The warranty period for the HDD and Fan is one year after purchase.

**This product is not for exclusive use of crime prevention but for assistance in cases as fire or theft. We take no responsibility for damage from any incident.**

**Caution**

As this equipment undergone EMC registration and suitable for business purpose, distributors and users are aware of this point.

FCC Compliance Statement

**Caution** : Any changes or modifications in construction of this device which are not expressly approved the party responsible for compliance could void the user's authority to operate the equipment.

**NOTE** : This equipment has been tested and found to comply with the limits for a Class A digital device, pursuant to part 15 of the FCC Rules. These limits are designed to provide reasonable protection against harmful interference when the equipment is operated in a commercial environment. This equipment generates, uses, and can radiate radio frequency energy and, if not installed and used in accordance with the instruction manual, may cause harmful interference to radio communications, Operation of this equipment in a residential area is likely to cause harmful interference in which case the user will be required to correct the interference at his own expense.

**Warning**

This is a class A product. In a domestic environment this product may cause radio interference in which case the user may be required to take adequate measures

**Warning**

1. In case of changing built-in lithium battery, it should be replaced as same or kindred one to prevent a danger of explosion. Since old batteries could be a factor of environment contamination, be cautious to treat them.
2. Do not throw the batteries to fire or heating. Neither short circuit or disassembly is prohibited.
3. Do not charge the batteries provided with Remote Controller

### **Important Notice**

1. Do not place heavy objects on the top of the product.
2. Product is for indoor use. It is not weatherproof. Use product with referring to its environmental specifications (Temperature & Humidity). To clean the product, gently wipe the outside with a clean dry cloth.
3. Product uses AC power of 110V ~ 240V. Be cautious not to cause electric damages to product.
4. Be careful not to drop the product. Physical shocks may harm the product including internal HDD. In addition, be sure the product is secured after installation.
5. Product is made of metal. Therefore you can hurt human beings if you throw it to them or hit on them. When installing product, be cautious to locate on safe places where children are unreachable.
6. If Product does not operate properly, please contact the closest HUNT distributor for after sales service. Tampering or disassembling the product will void the warranty.
7. Security surveillance laws may differ for each country. Therefore, please contact the local region first to avoid any surveillance law violations.

Experience and technical skills are needed for the installation of this product as an improper installation may cause fire, electric shocks, or defects. Any installation job should be performed by the vendor you purchased this product from.

The content of this manual can differ according to firmware or Software upgrading, and the standard and appearance of products may be changed for the improvement of quality without an advance notice.

# Contents

<b>INTRODUCTION</b> .....	<b>1</b>
<b>KEY FEATURES</b> .....	<b>9</b>
<b>INSTALL MANUAL</b> .....	<b>12</b>
<b>1. FEATURE</b> .....	<b>12</b>
1.1 Supplied Accessories .....	12
1.1.1 T1600M/T800M/T400M Series .....	<b>Error! Bookmark not defined.</b>
1.1.2 T1600Q/T800Q Series .....	<b>Error! Bookmark not defined.</b>
1.2 Description & Function.....	14
1.2.1 Front .....	14
1.2.2 Rear.....	18
1.2.3 REMOTE CONTROLLER .....	21
<b>2. INSTALLATION</b> .....	<b>2 3</b>
2.1 Installation and Connection .....	2 3
2.1.1 Connecting & Running .....	2 3
2.2 Running OSD menu .....	2 5
2.2.1 OSD menu configuration .....	2 5
2.2.2 Setting remote controller .....	2 6
2.2.3 Install examples.....	2 7
2.2.4 Basic Setting .....	2 9
2.3 Connecting and configuring DIO ports .....	3 3
2.3.4 HDD.....	4 4
2.3.5 Remote monitor and control.....	4 5
<b>USER MANUAL</b> .....	<b>4 7</b>

<b>3</b>	<b>MENU USE .....</b>	<b>4 7</b>
3.1	Menu Structure .....	4 7
3.2	Function Menu .....	4 7
3.3	Factory Reset .....	4 8
<b>4</b>	<b>MONITORING .....</b>	<b>5 4</b>
4.1	Basic Screen .....	5 4
4.2	Single FII Screen Mode .....	5 4
4.3	Multi Screen Mode.....	5 4
4.4	Screen Description .....	5 5
4.5	Auto Switch Mode.....	5 5
4.5.1	System Standard Mode.....	5 5
4.5.2	User Sequence Mode.....	5 6
4.6	Event Screen .....	5 7
4.7	Zoom Screen Mode .....	5 8
4.8	Pause Live Screen .....	5 8
4.9	PTZ Control .....	5 9
4.9.1	Pan/Tilt.....	6 0
4.9.2	Zoom/Focus.....	6 0
4.9.3	Load Preset .....	6 0
4.9.4	Save Preset .....	6 0
4.9.5	Auxiliary On.....	6 0
4.9.6	Auxiliary Off.....	6 1
4.9.7	Menu .....	6 1
<b>5</b>	<b>PLAYBACK.....</b>	<b>6 2</b>

5.1	Playback Mode .....	6 2
5.1.1	Playback on Standard monitor (16 / 9 / 4 division) .....	6 2
5.1.2	Playback function .....	6 2
5.2	SEARCH MODE .....	6 3
5.2.1	Time Search .....	6 3
5.2.2	Schedule Search .....	6 3
5.2.3	Event Search .....	6 4
5.2.4	Thumbnail Search .....	6 5
5.3	Copy .....	6 6
5.3.1	CD/DVD .....	6 6
5.3.2	RE4 .....	6 7
5.3.3	AVI .....	6 8

## **6. CONFIGURATION..... 6 9**

6.1	Recording Structure.....	6 9
6.2	System Setup .....	6 9
6.2.1	Date/Time .....	6 9
6.2.2	Disk.....	7 2
6.2.3	User Setup .....	7 4
6.2.4	Utility.....	7 6
6.3	Network.....	7 8
6.3.1	xDSL.....	8 0
6.3.2	WRS .....	8 0
6.4	Device Setup .....	8 1
6.4.1	Camera Setup .....	8 2
6.4.2	Monitor Setup .....	8 3
6.4.3	Audio Setup.....	8 4
6.4.4	Text Setup .....	8 5
6.4.5	Serial Setup.....	8 6
6.5	Event Setup .....	8 7
6.5.1	Event Check .....	8 8

6.5.2	Sync Event .....	8 9
6.5.3	Motion Detection .....	9 1
6.5.4	Sensor .....	9 2
6.5.5	Preset .....	9 2
6.6	Recording setup .....	9 4
6.6.1	Program setup.....	9 4
6.6.2	Manual/Schedule recording setup.....	9 6

## **7. WEB VIEWER ..... 1 0 0**

7.1	System requiriement .....	1 0 0
7.2	Login .....	1 0 0
7.3	User Setup.....	1 0 1
7.4	Browser available .....	1 0 1
7.5	Monitor.....	1 0 2
7.5.1	Screen division and changing video position .....	1 0 2
7.5.2	Move to Playback .....	1 0 3
7.5.3	Channel On/Off .....	1 0 4
7.5.4	Sensor Indication.....	1 0 4
7.5.5	Relay opeartion .....	1 0 4
7.5.6	Using microphone .....	1 0 4
7.5.7	Event data .....	1 0 5
1.2.1.	Video Recording & Save saving.....	1 0 5
7.5.8	UsingPTZ .....	1 0 6
7.5.9	Using Audio .....	1 0 7
7.5.10	Closing Video Channel.....	1 0 7
7.6	Playback .....	1 0 8
1.2.2.	Video Division & Changing Channel .....	1 0 8
7.6.1	Image recording .....	1 0 8
7.6.2	Printing .....	1 0 9
7.6.3	Backup .....	1 0 9
7.6.4	Web Monitor .....	1 1 0



7.6.5	Channel On/Off .....	1 1 0
7.6.6	Saving time & Checking Rec. Capacity.....	1 1 0
7.6.7	Searching Calander .....	1 1 0
7.6.8.	Functional function at the buttom of monitor .....	1 1 1
<b>8.</b>	<b>USER MANUAL FOR MOBILE VIEWER .....</b>	<b>1 1 2</b>
8.1	Log-In page .....	1 1 2
8.2	Monitoring page.....	1 1 2
	<b>TROUBLE SHOOTING .....</b>	<b>1 1 4</b>
	<b>AVAILABLE HDD.....</b>	<b>1 1 6</b>
	<b>COMPATITABLE CD/DVD LIST.....</b>	<b>1 1 7</b>
	<b>SPECIFICATION .....</b>	<b>1 1 7</b>
	HVRM-T1600M, HVRM-T800M, HVRM-T400M .....	1 1 7
	HVRM-T1600Q, EH800L.....	1 2 0
	<b>PRODUCT SIZE.....</b>	<b>1 2 3</b>

# KEY FEATURES

## Monitoring Screen

Supports real live video with high resolution per each channel and variable display mode.

- Real H.264 Video
- Variable display mode
  - HVRM-T1600M : 1/4/9/10/16 channel mode
  - HVRM-T800M : 1/4/9 channel mode
  - HVRM-T400M : 1/4 channel mode
  - HVRM-T1600Q : 1/4/9/10/16 channel mode
  - HVRM-T800Q : 1/4/9 channel mode
- Auto Switching
  - HVRM-T1600M : Composite x 2, DVI x 1
  - HVRM-T800M : Composite x 2, DVI x 1
  - HVRM-T400M : Composite x 2, DVI x 1
  - HVRM-T1600Q : Composite x 2, VGA x 1
  - HVRM-T800Q : Composite x 2, VGA x 1

## Audio Recording

Supports real-time audio input and recording

- Simultaneous 4ch audio input & recording available
- Input : 4Ch, Output : 1ch (Rear)
- Simultaneous audio recording and playback available

## Recording

It supports max. 480ips/HVRM-T1600M, 240ips/HVRM-T800M, HVRM-T1600Q, 120ips/HVRM-T800Q, HVRM-T400M

recording at High-Resolution (H.264) and available to record max. 5

seconds before triggering an event. Also, convert function is available protecting privacy.

- H.264 Video recording with High-Quality  
  
HVRM-T1600M : CIF(360x240) 480ips  
  
HVRM-T800M : 2CIF(704x240) 240ips  
  
HVRM-T400M : D1 (704x480) 120ips  
  
HVRM-T1600Q : CIF(360x240) 240ips  
  
HVRM-T800Q : CIF(360x240) 240ips
- Supports manual & schedule recording
- Video loss detection
- Supports archiving event list(Sensor, Video Loss, Motion detection, Text)
- Available record Max 5 seconds before triggering an event per each channel

## Search/ Playback

It supports variable and convenient functions for search & playback

- Play back by time, date, Channel
- Easy and convenient search using mouse
- Pre/post search from a freeze frame
- Play back by Event (Sensor, Video Loss, Motion Detection, Text)
- Easy & convenient search using Remote Controller & Jog/ Shuttle (except HVRM-T1600Q, HVRM-T800Q)

## Back up device

It is available to backup to DVD-R, CD-R, USB memory by user's choice.

(HVRM-T1600Q, HVRM-T800Q is available as an option.)

- Supports various back up device : DVD-R, CD-R, USB memory
- Extension HDD Storage (External extension Storage device)

## Network

It supports variable network like LAN, XDSL and easily control from remote site using PC client viewer.

- E-mail notification thru. TCP/IP, DHCP in case of triggering an event
- Live monitoring from remote site (Whole screen or available to select quad screen)
- Available to playback, recording, search and DVR management thru. network viewer in PC
- Available to record, search & playback by time from remote site.
- Supports 10/100Mbps Ethernet/xDSL
- Multiple DVR connection

## Etc.

- Supports User friendly GUI and mouse function
- Easy and simple firmware upgrade thru. USB memory
- Recorded data back up thru. USB port
- PTZ Control (SPEED DOME), PRESET function
- Available to control up to 16 DVRs with one remote controller

# Install Manual

## 1. Feature

### 1.1 Supplied Accessories

Unpack and check all the items as below

#### 1.1.1. T1600M/T800M/T400M Series

AC Cord, Remocon, Setup CD, SATA Cable, HDD Fixing Screw, Quick Guide

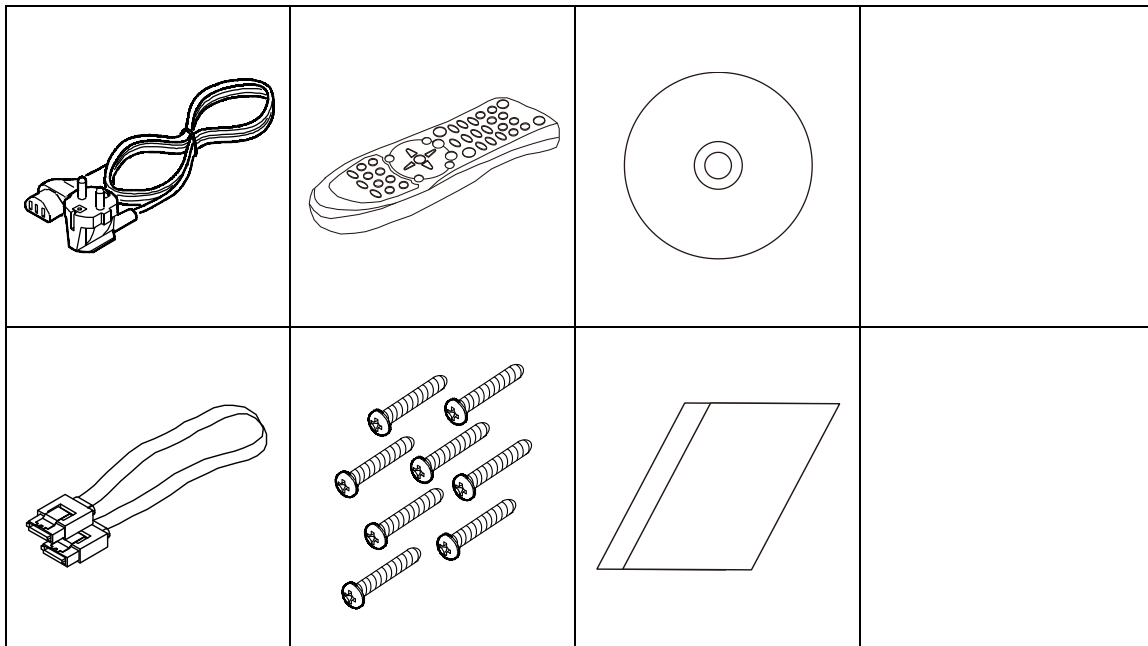

### 1.1.2. T1600Q/T800Q Series

AC Cord, Remocon, Setup CD, SATA Cable, HDD Fixing Screw, Quick Guide

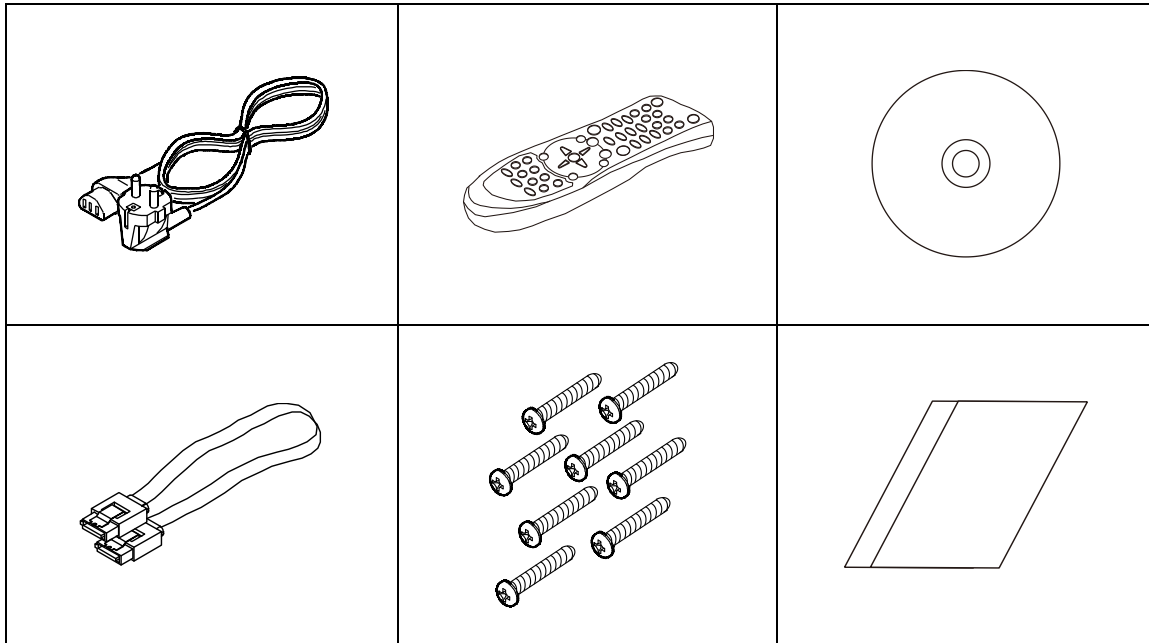

## 1.2. Description & Function

### 1.2.1. Front

#### 1.2.1.1. T1600M/T800M/T400M Series Front

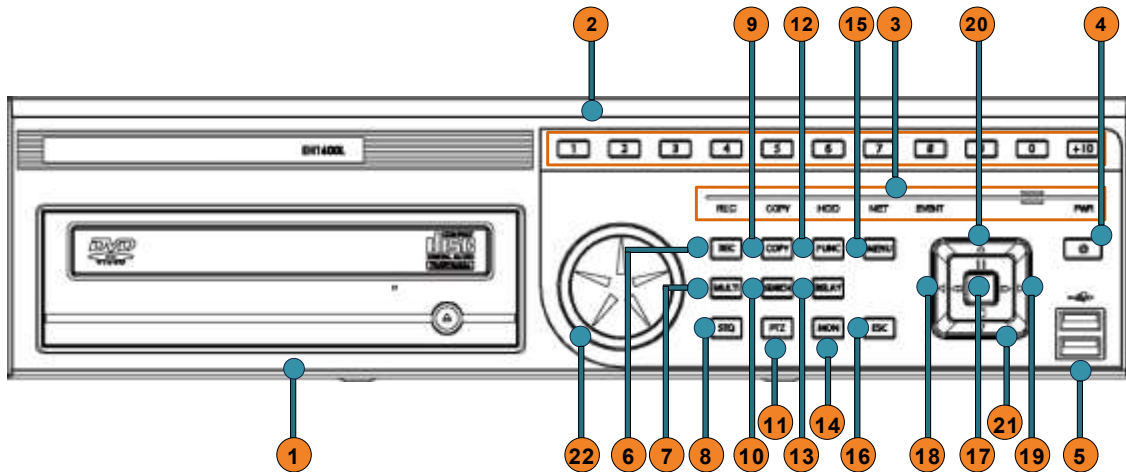

Item		Description
1	DVD-Multi (For Back up)	Back up use for recorded data by DVD/CD media
2	Channel Button	To select video input channel
3	REC LED	Displays recording status
	COPY LED	Displays copy status
	HDD LED	Displays HDD running.
	NETWORK LED	Displays network connection
	EVENT LED	Displays event detection
4	Power	Turn on/ off power
5	USB port	Use connecting USB memory or Mouse
6	REC	To start or stop manual recording
7	Multi	To change DVISION in live or playback mode
8	SEQ	To run or stop user sequence
9	Copy	To enter copy mode
10	Search	To enter search mode
11	PTZ	To start PTZ function or stop
12	Func	To enter function mode
13	Relay	Manual On/Off button for relay

14	Mon	To change Monitor/ Stop
15	Menu	To enter menu
16	ESC	To escape from menu or close pop-up window
17	Enter/Play	To enter playback mode or select menu
18	◀/REW	To move or select in menu and change replay speed to reverse direction in playback mode
19	▶/FWD	To move or select in menu and change replay speed to forward direction in playback mode
20	▲/Pause	To move or select in menu and pause live/ replay video
21	▼/Stop	To stop replay in playback mode
22	Jog/ Shuttle	STEP function control, Playback direction change, Playback speed control



1.2.1.2. T1600Q/T800Q Series Front

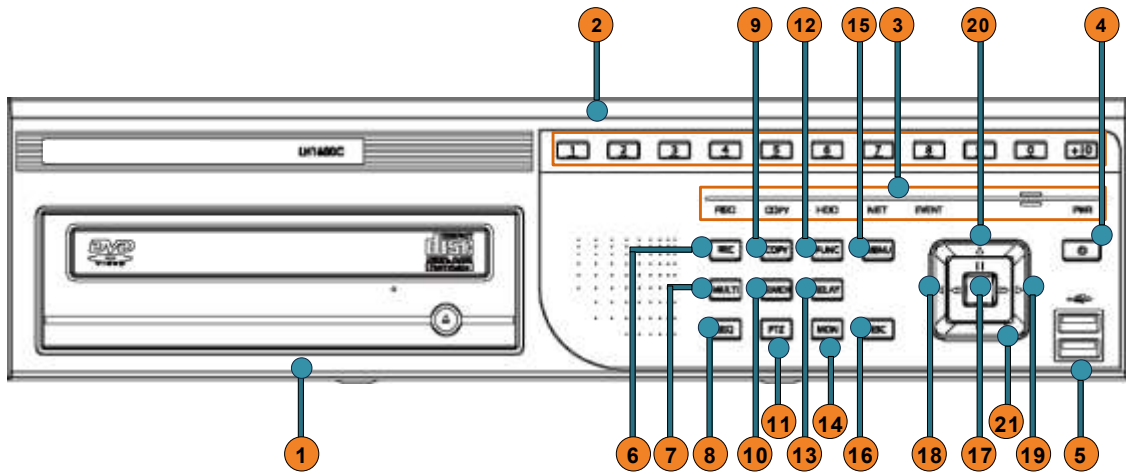

Item		Description
1	DVD-Multi (For Back up)	Back up use for recorded data by DVD/CD media
2	Channel Button	To select video input channel
3	REC LED	Displays recording status
	COPY LED	Displays copy status
	HDD LED	Displays HDD running.
	NETWORK LED	Displays network connection
	EVENT LED	Displays event detection
4	Power	Turn on/ off power
5	USB port	Use connecting USB memory or Mouse
6	REC	To start or stop manual recording
7	Multi	To change DVISION in live or playback mode
8	SEQ	To run or stop user sequence
9	Copy	To enter copy mode
10	Search	To enter search mode
11	PTZ	To start PTZ function or stop
12	Func	To enter function mode
13	Relay	Manual On/Off button for relay
14	Mon	To change Monitor/ Stop
15	Menu	To enter menu
16	ESC	To escape from menu or close pop-up window
17	Enter/Play	To enter playback mode or select menu

18	◀/REW	To move or select in menu and change replay speed to reverse direction in playback mode
19	▶/FWD	To move or select in menu and change replay speed to forward direction in playback mode
20	▲/Pause	To move or select in menu and pause live/ replay video
21	▼/Stop	To stop replay in playback mode

## 1.2.2. Rear

### 1.2.2.1. T1600M/T800M/T400M Series REAR

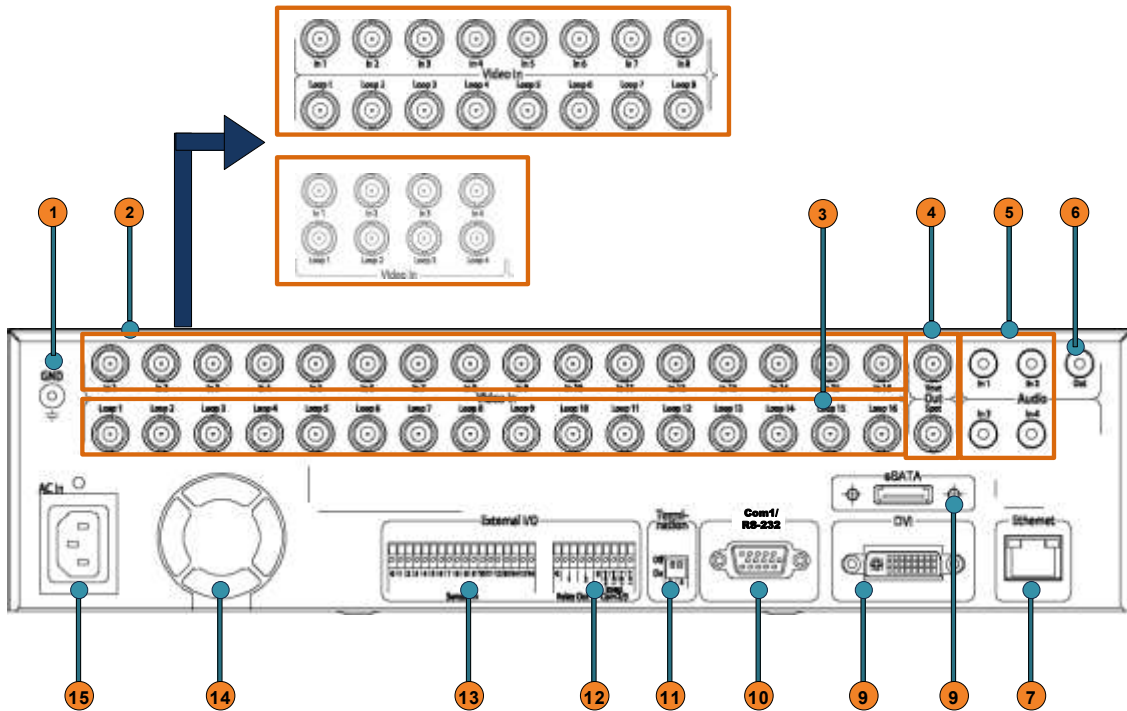

번호	Input/ Output name	Description
1	Ground	Ground between DVR & external device
2	CH1~16	BNC input for camera connection HVRM-T1600M : 16EA, HVRM-T800M : 8EA, HVRM T400M : 4EA
3	Loop out	BNC output(Loop) for camera connection
4	Monitor/ Spot	BNC connection for monitor output
5	Audio Input(RCA)	RCA connection for Audio input
6	Audio Output	Speaker output terminal
7	Ethernet	For network connection (RJ-45)
8	eSATA	eSATA external storage connection
9	DVI OUTPUT	Output for DVI monitor connection
10	RS-232C D-Sub	Text equipment, Keyboard connection
11	Termination Ohm	Termination Ohm for Com2, Com3
12	Relay/Serial	Connection for Relay and Serial(RS-485)
13	Sensor IN	Input for external sensor
14	FAN	Cooling system against over heating

<b>번호</b>	<b>Input/ Output name</b>	<b>Descrtiption</b>
<b>1</b>	Ground	Ground between DVR & external device
15	Power connector	Socket for AC100V~AC240V power cord

### 1.2.2.2. T1600Q/T800Q Series REAR

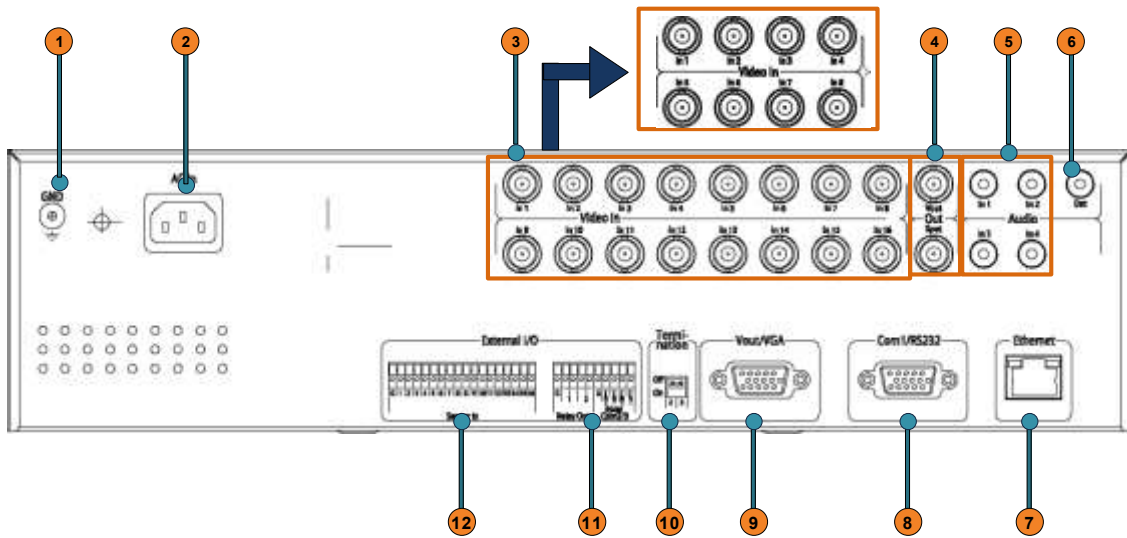

번호	Input/ Output name	Description
1	Ground	Ground between DVR & external device
2	Power connector	Socket for AC100V~AC240V power cord
3	CH1~16	BNC input for camera connection HVRM-T1600Q : 16EA, HVRM-T800Q : 8EA
4	Monitor/ Spot	BNC connection for monitor output
5	Audio Input(RCA)	RCA connection for Audio input
6	Audio Output	Speaker output terminal
7	Ethernet	For network connection (RJ-45)
8	RS-232C D-Sub	Text equipment, Keyboard connection
9	VGA OUTPUT	Output for VGA monitor connection
10	Termination Ohm	Termination Ohm for Com2, Com3
11	Relay/Serial	Connection for Relay and Serial(RS-485)
12	Sensor IN	Input for external sensor

### 1.2.3. REMOTE CONTROLLER

It is available to use all functions of DVR. If several DVR are set with unique ID numbers, they can be controlled with one remote controller. To use remote controller, it is necessary to set ID first which want use. Keep pressing ID button repeatedly (Up to Max. 16 times) and use it matching DVR & ID.

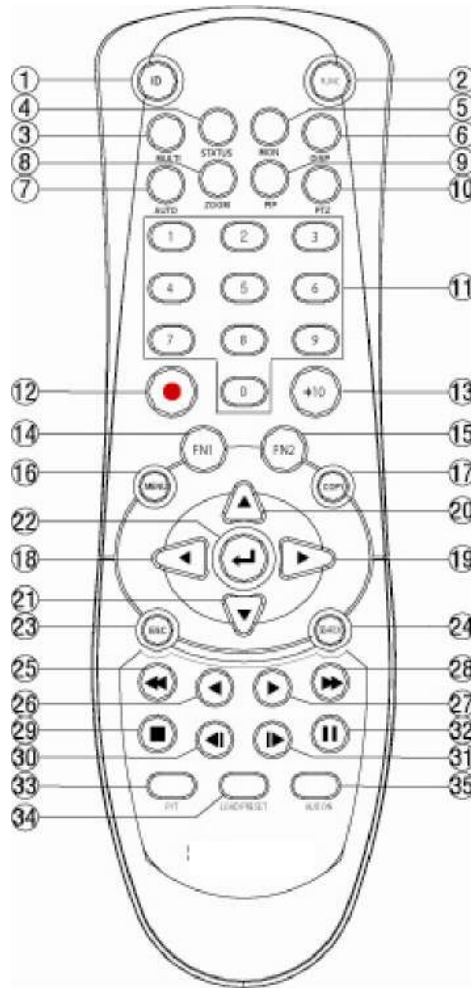

No.	Iten	Description
1	ID	To select Remote Controller ID
2	LOCK	Not use
3	COPY	To indicate copy menu, copy recorded data to USB
4	BACKUP	Not use
5	RELAY ON	To manually ON
6	RELAY OFF	To manually OFF
7	SEQ	Auto sequencing
8	MULTI	To change division
9	ZOOM	To run digital zoom

10	SEARCH	To indicate search menu
11	CHANNEL BUTTON	To select channel
12	SELECT	Not use
13	+10	In case of selecting over 10 (+10 + 1)
14	FN1	Not use
15	FN2	Not use
16	MENU	Covert to menu screen
17	HELP	Not use
18	◀/REW	Move setting menu to left direction/REW
19	▶/FWD	Move setting menu to right direction/FWD
20	▲/PAUSE	Move setting menu to top direction/PAUSE
21	▼	Move setting menu to bottom direction/STOP
22	ENTER/PLAY	Menu selection/Playback
23	ENTER	To select menu
24	EXIT	To cancel setting, escape from menu
25	FAST REWIND(◀◀)	Speedy replay to reverse direction
26	REWIND PLAY(◀)	Replay to reverse direction
27	FORWARD PLAY(▶)	Repleay to forward direction
28	FAST FORWARD (▶▶)	Speedy replay to forward direction
29	STOP(■)	To stop replay
30	STEP REVERSE(◀I)	Replay to reverse direction by each frame
31	STEP FORWARD (I▶)	Replay to forward direction by each frame
32	PAUSE(II)	To freeze playback
33	P/T	PAN/TILT Control
34	LOAD PRESET	To read preset
35	AUX ON	Auxiliary ON

## 2. Installation

### 2.1 Installation and Connection

#### 2.1.1 Connecting & Running

##### 2.1.1.1 Connecting camera

Connect CCTV camera to DVR with BNC cable as below

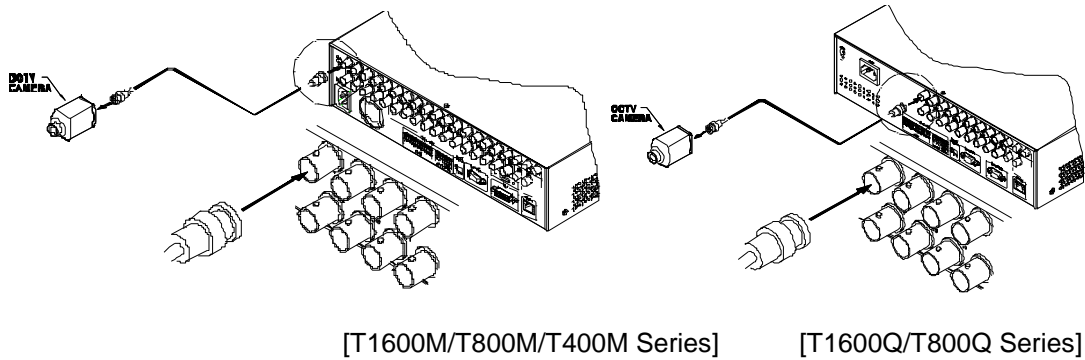

- The video type for all channels should be either NTSC or PAL, not be combined both
- DVR sets video signal's impedance (75Ω) automatically. Impedance is set as 75 Ω basically. If connecting a device to video output, impedance will be "Hi-z" status.
- Video Type (NTSC/PAL) should be changed after booting DVR. The order of camera recognition follows ch1 through Ch16 camera and 1<sup>st</sup> recognized camera type leads other camera type.

##### 2.1.1.2 Connecting monitor

Connect CCTV monitor to DVR with BNC cable as below.

Will be able to connect BNC, DVI and VGA.

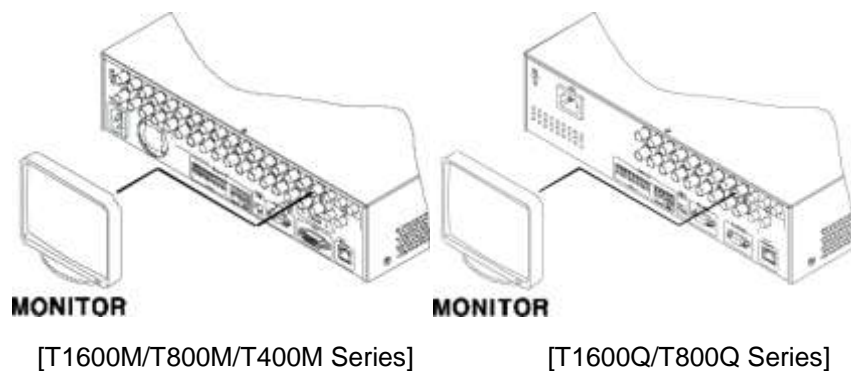



### 2.1.1.3 Connecting Audio

Connect audio signal to DVR with using RCA cable or D-SUB as below;

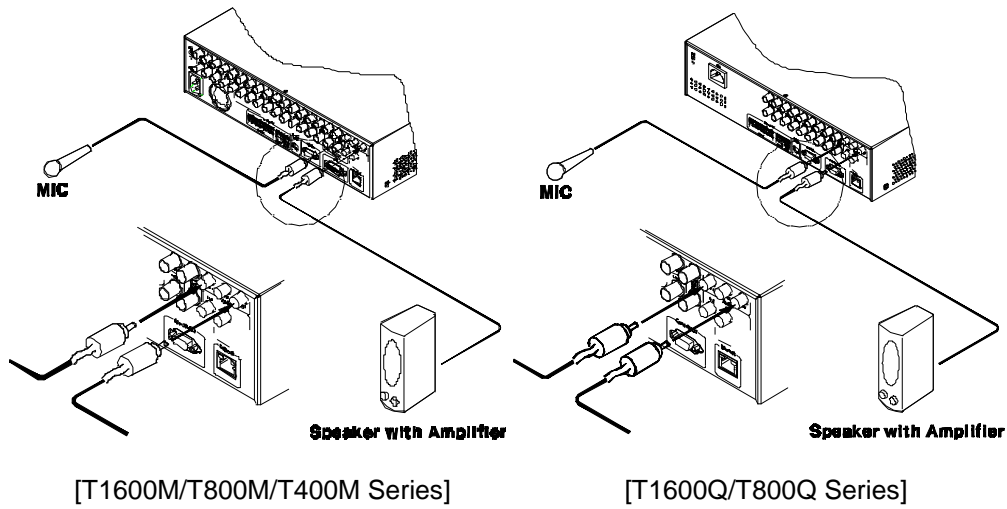

### 2.1.1.4 Supplying Power

Connect power cable as below;

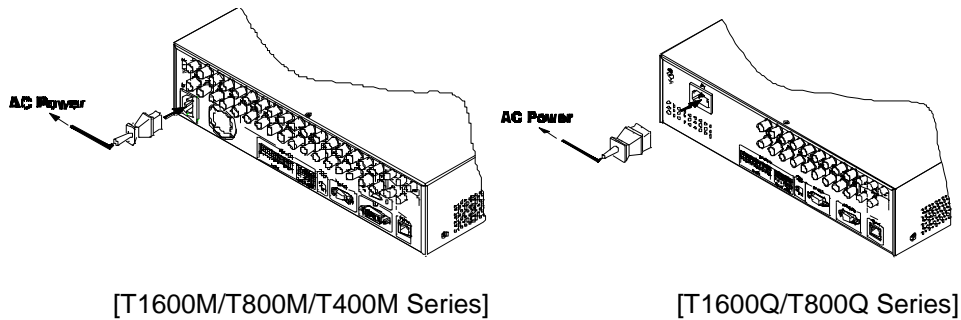

- When supplying power, DVR starts booting automatically.
- In order to cut off power, press power switch on DVR front during 5 seconds, then select "YES" after appearing a pop-up window.
- For supplying power again, push the Power button.

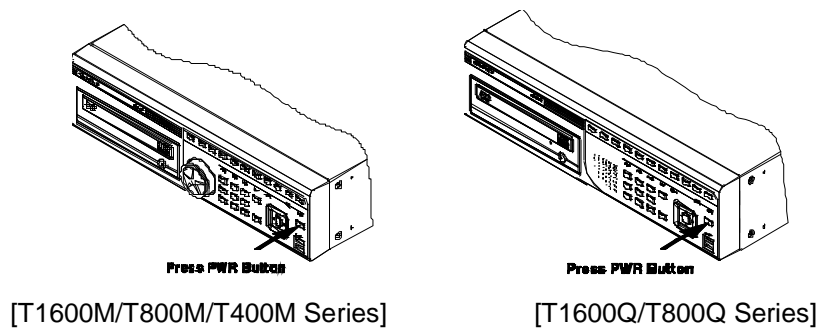

## 2.2 Running OSD menu

### 2.2.1 OSD menu configuration

Press [MENU] in keypad of front to open configuration menu as below;



(1) **Main Menu** : The selected tab is show in bright color and the related sub-menu will be shown left- below the tab. To move to the previous/next tab, use the [◀/▶] arrow buttons. To move to a sub-menu press the [Enter] key.

(2) **Sub-menu** : The selected sub-menu is shown as tab title and the related setting will be shown. To move to the previous/next tab, use the [◀/▶ ▲/▼] arrow buttons. To move to the related setting press [Enter]. To move to upper main menu, press [ESC] button.

(3) **Setting page** : The selected tab is shown as orange, To move to the previous/next tab, use the [◀/▶] or [▲/▼] arrow button and press [Enter] key for value setting. Whn setting value is a word, a dialogue box to edit the word will be open. When setting value is number, it should be set with using [◀/▶] or [▲/▼]. Press [ESC] button when the value is set and also [ESC] button is available to upper sub-menu.

#### 2.2.1.1 Dialogue box to edit a word

Dialogue box to edit a word is image shown as below; It is available to input both word and bumber.



Keep pressing [▲/▼], [◀/▶] arrow button until the word is looking for and press Enter. In case of deleting input word press [←], spacing words press [→] button. To exit from dialogue box, press [Enter] after finishing word input.

## 2.2.2 Setting remote controller

### 2.2.2.1 Setting ID of DVR

When controlling several DVRs with one remote controller, set Remote Control ID as follows;



- (1) Press the [MENU] button
- (2) [▶] Select “system” with using [▶] arrow button and press [Enter] or [▼] button
- (3) [▼] Select “Utility” with using [▶] arrow button and press [Enter] button.
- (4) Select “Remote Control ID” and press [Enter]
- (5) [◀/▶] Select a value using [◀/▶] arrow buttons and press [ESC]
- (6) Press the [ESC] button to return to the monitor mode.

#### <Reference>

**Up to 16DVRs can be controlled with a single remote controller.**

**When not using remote controller, set the Remote Control ID as “Off”**

### 2.2.2.2 Selecting ID

If several DVRs are with unique ID numbers, they can be controlled with one remote controller.

To select a specific DVR, keep pressing the ID button of remote controller until a buzzer sounds during 2 seconds.

### 2.2.2.3 Operable range of remote controller

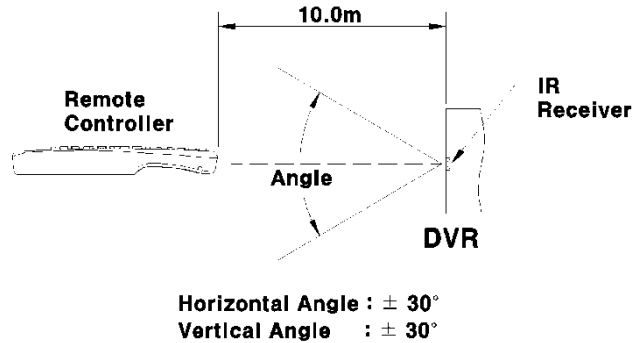

### 2.2.2.4 Loading the batteries into the remote controller

Remote controller required two AAA-type batteries. Please, refer the following installation step.

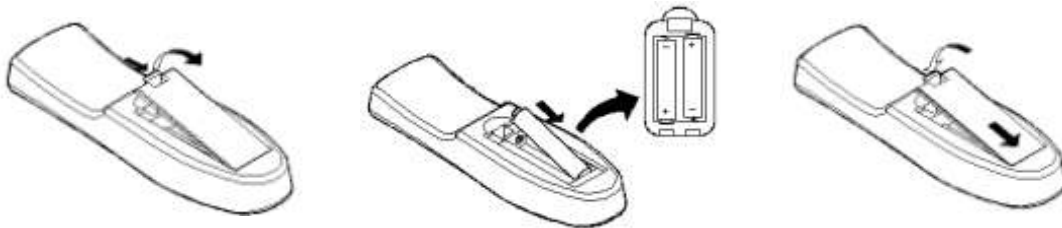

1. Remove the battery cover
2. Taking care the the poles (+/-) are correctly positioned.
3. Replace the battery cover

## 2.2.3 Install examples

### 2.2.3.1 Basic configuration

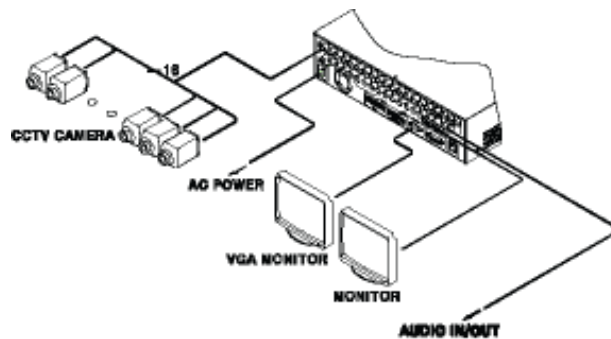

[T1600M/T800M/T400M Series]

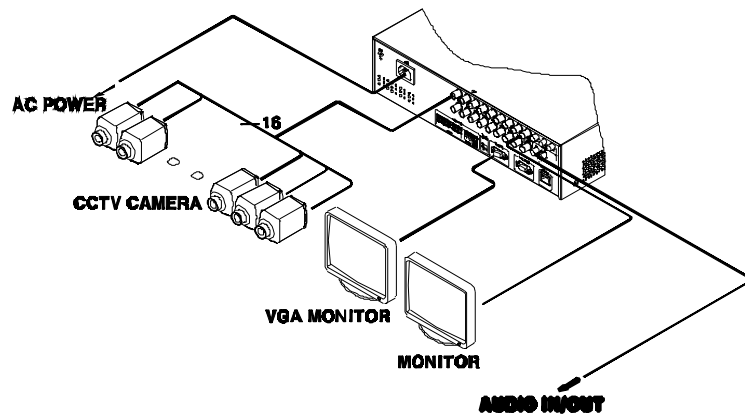

[T1600Q/T800Q Series]

### 2.2.3.2 Advance configuration

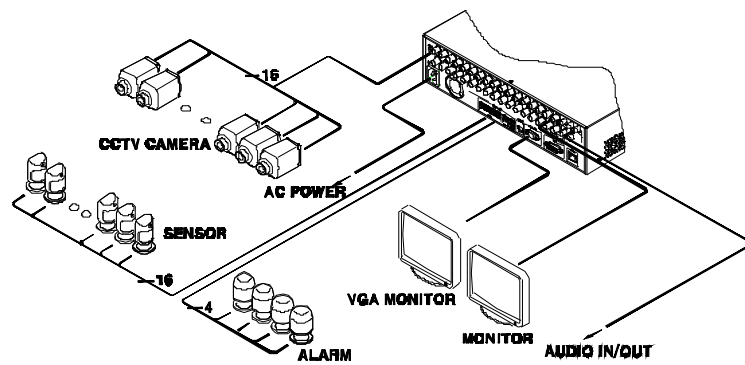

[T1600M/T800M/T400M Series]

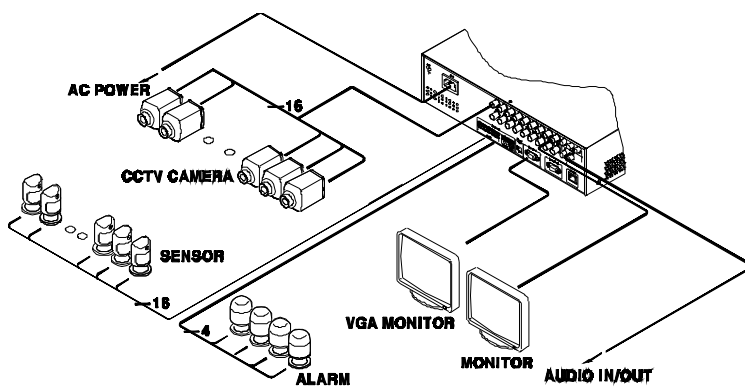

[T1600Q/T800Q Series]

### 2.2.3.3 External storage & Back up configuration

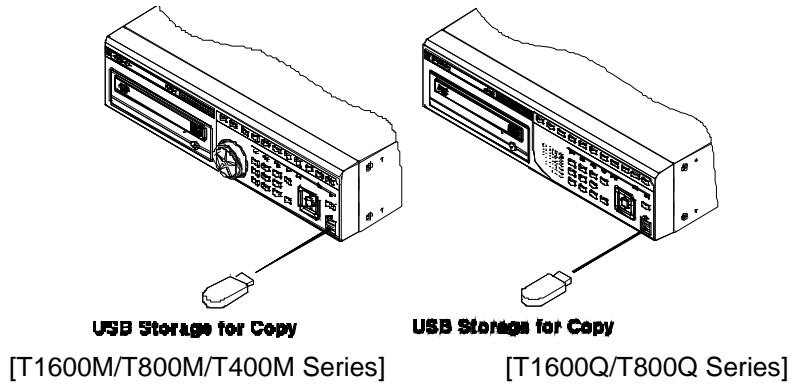

### 2.2.3.4 Internet/ Intranet configuration

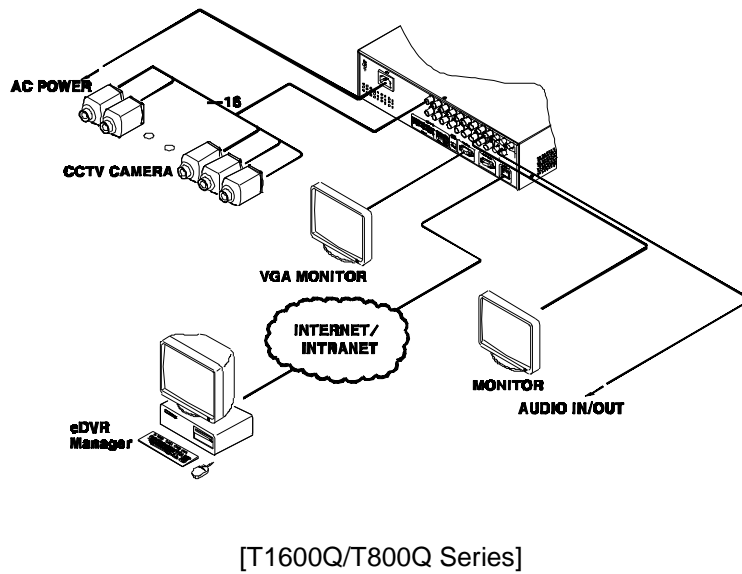
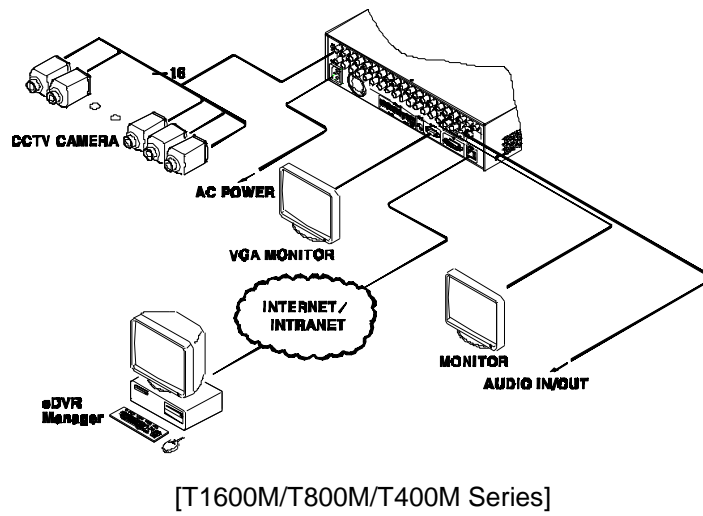

### 2.2.4 Basic Setting

### 2.2.4.1 Viewing Image

When power is on, eDVR starts automatically and displayed in basic 16ch-split screen after booting.

<Reference>

If user password is set, a prompt for entering the password will be appeared. Factory default is reserved as not responding keypad on DVR front (It is not from factory default).



### 2.2.4.2 Setting Date & Time



- Press [MENU] button and select " System" when OSD menu is appeared.
- Select "Date/Time" and press [Enter] button.

#### Time Zone

- (1) Select "Time Zone" using [◀/▶] or [▲/▼] arrow button and press [Enter] button.
- (2) [◀/▶] Select "Time Zone" using [◀/▶] arrow button and press [ESC] button.

#### Daylight saving

- (1) Summer Time is only activated for Time Zine that uses Daylight savings.
- (2) Select "Daylight Saving" using [◀/▶] or [▲/▼] arrow button and press [Enter] button.

- (3) Select On/Off using [◀/▶] arrow button and press [ESC] button.

### **NTP**

- (1) Select NTP Function
- (2) Select “Client or Server or Both” using [◀/▶] or [▲/▼] arrow button and press [Enter] button.
- (3) Select “Public or Both” using [◀/▶] arrow button and press [ESC] button  
on ‘Client or Both’ mode.
  - (4) Enter ‘Server IP address’ when you set the next server as Local.
  - (5) Set Server and Communicate cycle with Interval.

### **Date Format**

- (1) Select “Date Format” using [◀/▶] or [▲/▼] arrow button and press [Enter] button. Select a value using [◀/▶] arrow button from YYYY/MM/DD, MM/DD/YYYY, DD/MM/YYYY.
- (2) Press [ESC] after finishing value setting.

### **Time**

- (1) Select “Time” using [◀/▶] or [▲/▼] arrow button and press [Enter] button.
- (2) Select Date, Time using [◀/▶] arrow button and set value using [▲/▼] arrow button.
- (3) Press [ESC] after finishing value setting.

### **Apply**

Most setting values are applied automatically, when exiting from the related menu page. But “Date” & “Time” setting are not applied automatically because they may critically affect the file system of the recorded HDD. To apply Date/ Time settings confirm with [Apply Date/Time] buttons.

- (1) Select “Apply Date/ Time” using [◀/▶] or [▲/▼] arrow button and press [Enter]. Then, a warning message will be appeared as below image;
- (2) Select using [◀/▶] or [▲/▼] arrow button and select “YES”, then, press [ENTER] button.  
To cancel, press [ESC] button.





### 2.2.4.3 Record Setting

Select "Record" pressing menu button in front.



#### Program Setting

Set resolution, frame rate, quality by each channel that user want record in "Program" of record menu.



#### Schedule Setting



Set recording mode as “Scheduel & Event” and set by date/ time.  
 Checking method for recording

<Reference>

If recodrding setting is finished correctly, “REC LED” in front is flickering. In addition, it is marked [S] indicating that all channels are recroding.

## 2.3 Connecting and configuring DIO ports

### 2.3.1 Wire Handling

When connecting a wire to a terminal block, follow the instruction below. Not the different types of wire that can be used.

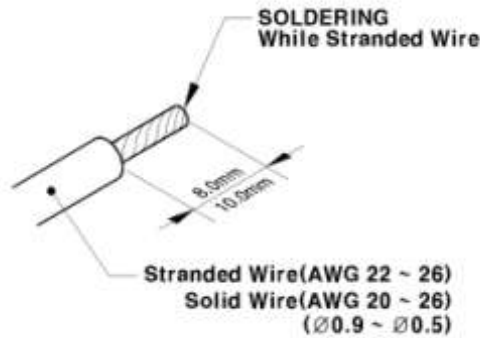

- Standard wire : Pie off the wiring cover 8~10mm and solder it. Wire gage should AWG 22~26.
- Sold wire : Peel off the wiring cover 8~10mm and solder it. Wire gage should be AWG 20~26

### 2.3.2 Inserting & removing wire

To insert & remove wire in Terminal Block, use a screwdriver in the diagram to the below;

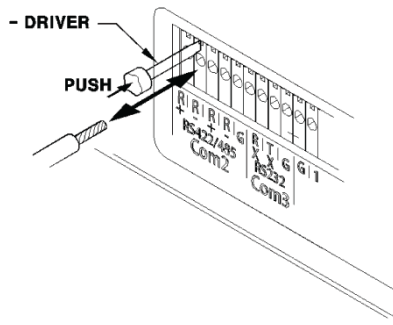

### 2.3.3 Connecting and configuring sensor

#### 2.3.3.1 Specification

In order to run sensor input DVR normally, the following conditions are required.

Spec	Input Ch	Transistor input HVRM-T1600M, HVRM-T1600Q : 16EA, HVRM-T800M, HVRM-T800Q : 8EA HVRM-T400M : 4EA
	Input type	N.C, N.O supprt
	Supported sensor	Dry contact sensor
	Way of connecting	Connecting the trimmed wire to terminal block
Performance	Available input pulse range	Minimum 500ms
	Output current	Typical DC 12mA

#### Connecting sensor input

Connect S1 ~ S16(S8, S4) with referring the following image. It shows to connect a dry contact (Please refer “Wire Handling”).

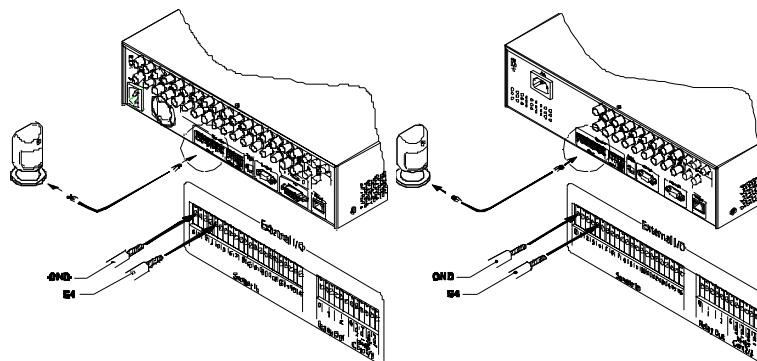

[T1600M/T800M/T400M Series]

[T1600Q/T800Q Series]

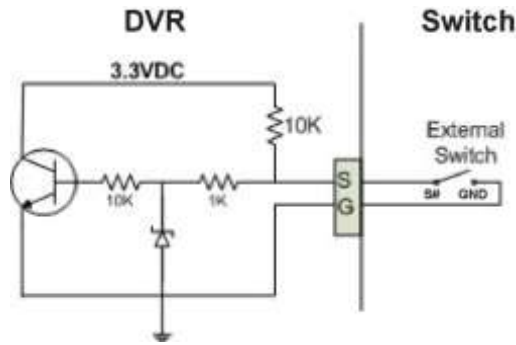

### Setting Sensor

- (1) Press [Menu] button and select "Event" when OSD menu is appeared.
- (2) Move to sub menu pressing [Enter] or using [▼] button and select [Enter]



#### All sensor

It is used when setting for all sensors and set Off, or Normal Open (N.O.) / Normal Close (N.C.) type.

- (1) Select All and set type.

#### Each sensor

It is used when setting for each sensor and set selecting each sensor.

- (1) Select sensor and press [Enter] button.
- (2) Select sensor that user want set and set type
- (3) Press [ESC] after finishing value setting.

### 2.3.3.2 Connecting relat and setting

#### Specification

In order to run relay output of DVR normally, the following conditions are required.

SPEC	Output Ch.	2EA relay outputs
	Output type	Dry contact
	Connecting type	Connect the trimmed wire to terminal block
Perfromance	DC	30V 1A
	AC	125V 0.5A

#### Connecting relay out

Connect R1 ~ R2 with referring to the following images, it shows to connect a warning light. Please refer the “Wire Handling”.

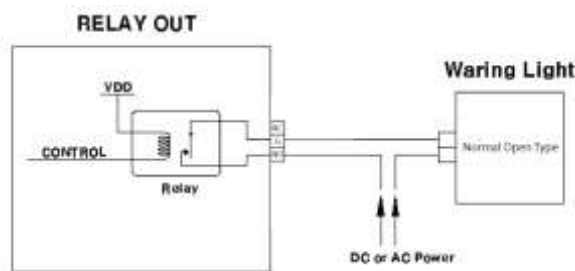
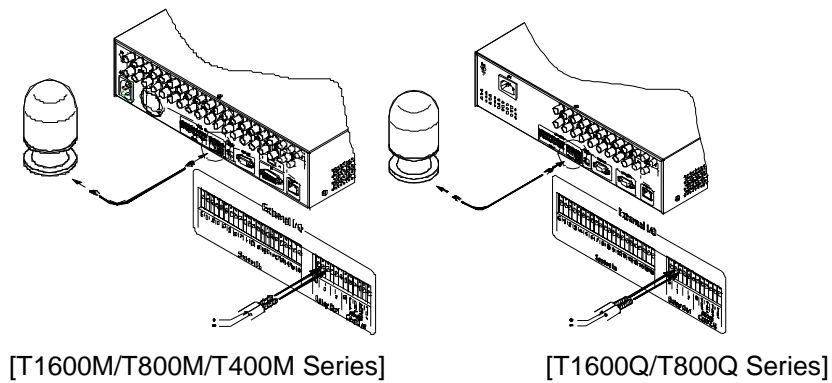

#### Relay setting

It is available to run relay selecting from sensor, motion detection, Video Loss which is normal event source and Disk error, Disk full, authentication fail, WRS registration fail which is system event source. Also, user can set working condition by schedule. In case of using control center thru. network, realy could be run from remotely.



### 2.3.3.3 Connecting serial port

#### Configuring serial ports for Pan/Tilt/Zoom

If DVR supports thru. COM port, it is available to connect PTZ camera and control it. For a list of supported protocols, please refer to the list on the OSD configuration menu. The following figure shows how to connect PTZ camera to RS485 (COM2/COM3). When using another serial port, connect it with referring to each connection diagram below.

Please refer the “Wire Handling”.

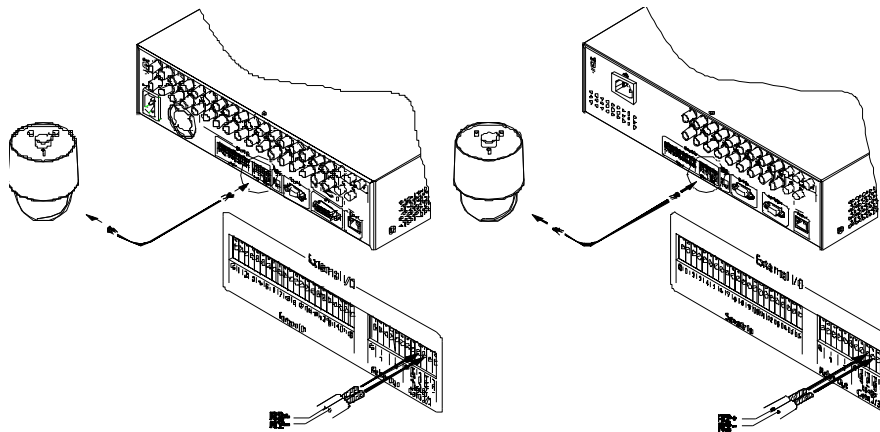

[T1600M/T800M/T400M Series]

[T1600Q/T800Q Series]

Serial communication port diagram

COM1 Connection (RS-232)

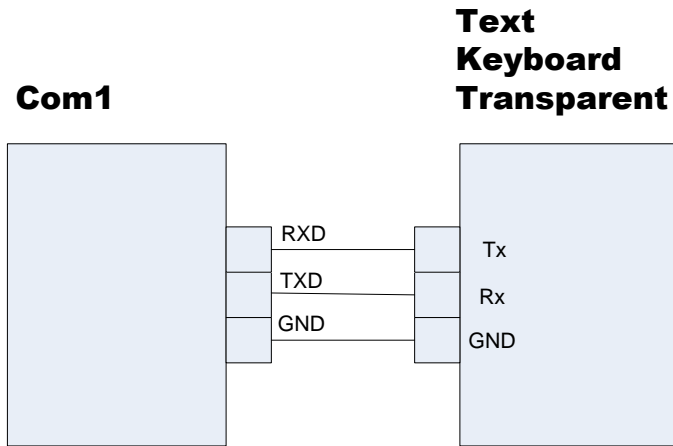

COM2/COM3 Connection (RS-485)

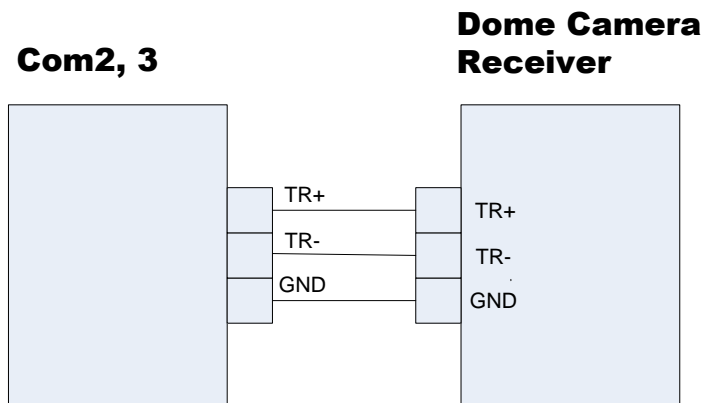

Available PTZ is same as below table.

Model Name	Manufacturer
Keyboard KBD300A, WGI SPD1800/2600	Webgate
WKC-100 Keyboard	Webgate
BOSCH AutoDome, TC8560X-4	Bosch
PELCO(P), PELCO(D)	Pelco
Sony EVI-D3x	Sony
VT VPT-4x	VT
AD SpeedDome	AD
SungJin SJ372R1'	Sungjin

Samsung SCC641	Samsung Electric
Panasonic WV-CS850	Panasonic
SDZ160/330, Samsung SPD, Keyboard SCC3000, Samsung SRX-100B	Samsung Techwin
LG GAC-PT2	LG
Merit-Lilin FastDome	Merit
Elmo PTC200C	Elmo
Canon VC-C4	Canon
HTC-230S	Dongyang Unitech
Honeywell 755/655, HRX-2000, ScanDome2	Honeywell
RVision	RVT
Elbex	Elbex
VIDO	VIDO
VICON	Vicon
Hunt	Hunt
ORX-1000	Systemia
Fine CRR-1600	LiveEye
Tokina	Tokina
Kodicom KRE	Kodicom
Nuvico	Nuvico

### Serial Setting

You can set up both serial port and PTZ from remote menu under network menu.



From serial setting, you can set protocol, port, baudrate, parity bit, stopbit and databit.

After completed serial setting, select desired channel from camera menu, and setting up PTZ Home, PTZ Idle Time, PTZ Port, and PTZ address.





### 2.3.3.4 Connection to external device via Serial port

#### Text input device connection (ATM / POS / Access Control)

Using COM1/RS232, TEXT DATA can be recorded with synchronizing POS/ATM.

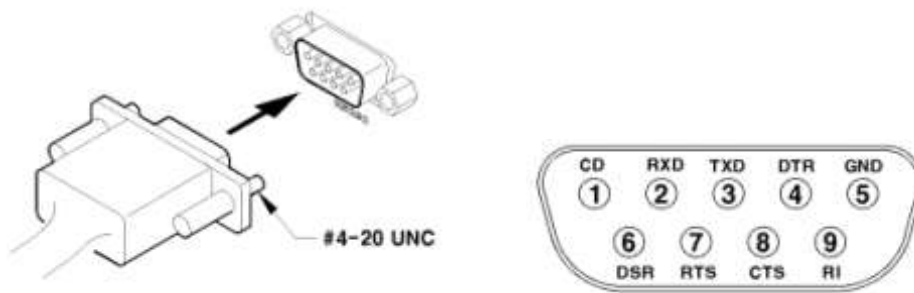

Like above picture, connect COM1/RS232 (9pin D-Sub) in Device menu and configure Serial and Text.

#### Serial (COM1) Setup



- (1) Select "Device" in OSD menu and move to sub menu.
- (2) Seleting COM1 and configure "Text" in Device
- (3) Setup the value of Baud Rate/Parity/Stop bit/Data bit with the device.

**Text Set up**

- (1) Select “Deice” on OSD, and move to sub menu.
- (2) Select “Text”and configure relevant text information



<Reference>

Since external device can not be recognized, before installing, please, ask to the shop.

**2.3.3.5 USB Device Connection**

USB port is for the simple video copy (within 1 hour) on USB Flash memory. Its recommended specification is same as below.

USB Spec.	Ver 2.0
Device	USB Memory Stick,
Voltage/electric current	Max. 200mA per DC 5V / Port

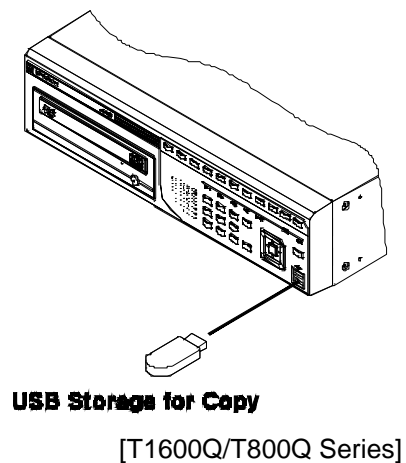
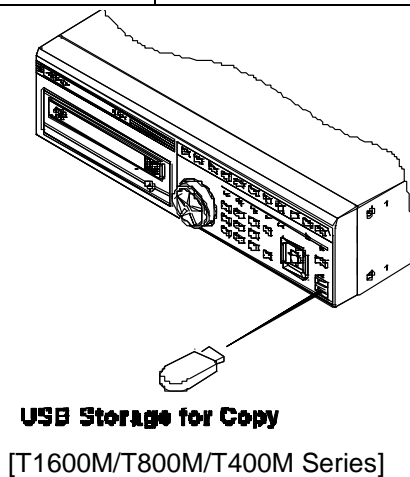

<Reference>

It should be formatted by FAT32.

In case of normal connection, if executing Copy menu, disk will be recognized same as below and Set copy range → Select Drive → Execute Copy.



[CD/DVD Copy]

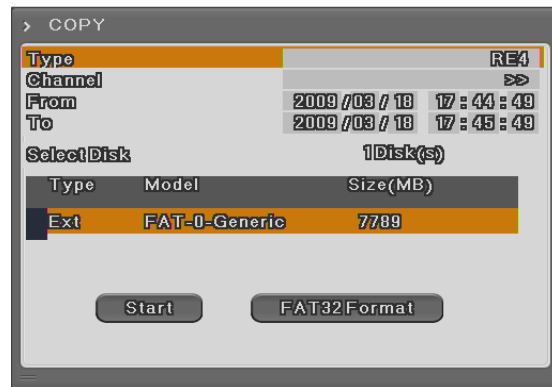

[RE4 Copy]

Select the channel to copy





[AVI Copy]

<Reference>

A USB Flash memory which should install additional program on Windows OS, can not be recognized.

**2.3.3.6 Video In/Out connection**

Video Input/Output is Loop through and check the connectivity automatically and set end resistance.

For instance, if connected by Video input, end resistance is configured by 75Ω and if Video in/output is same, it will be Hi-z mode. Therefore, in case that Input/Output are connected at the same time, end resistance of device receiving output should be configured by 75Ω.

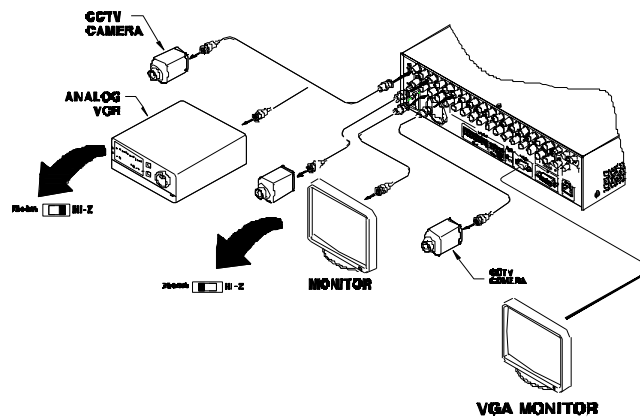

[T1600M/T800M/T400M Series]

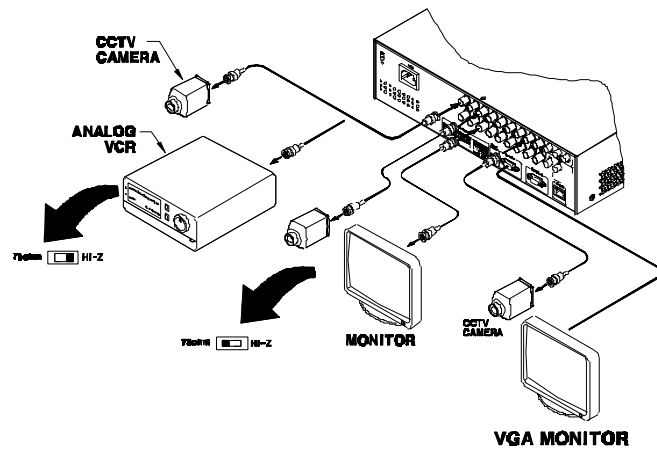

[T1600Q/T800Q Series]

### 2.3.3.7 Audio In/Out connection

There are 4 RCA Audio Input and 1 RCA output.

### 2.3.4 HDD

※ Please, refer to Appendix for available HDD list

#### 2.3.4.1 HDD registration and format

After mounting HDD and booting system, “Disk Manager” will execute automatically.

If not, please, check the connectivity of HDD.



- (1) Press [Enter] button in “Disk Manager”
- (2) Using [▲/▼] Key, select new HDD(Displayed [No] on Enabled item) and press [Enter]
- (3) If you see the message for format, select [Yes].
- (4) Press [ESC] and escape from “Disk Manager”

## 2.3.5 Remote monitor and control

Via Internet/Intranet, in remote site, user can access with PC.

### 2.3.5.1 Ethernet connection

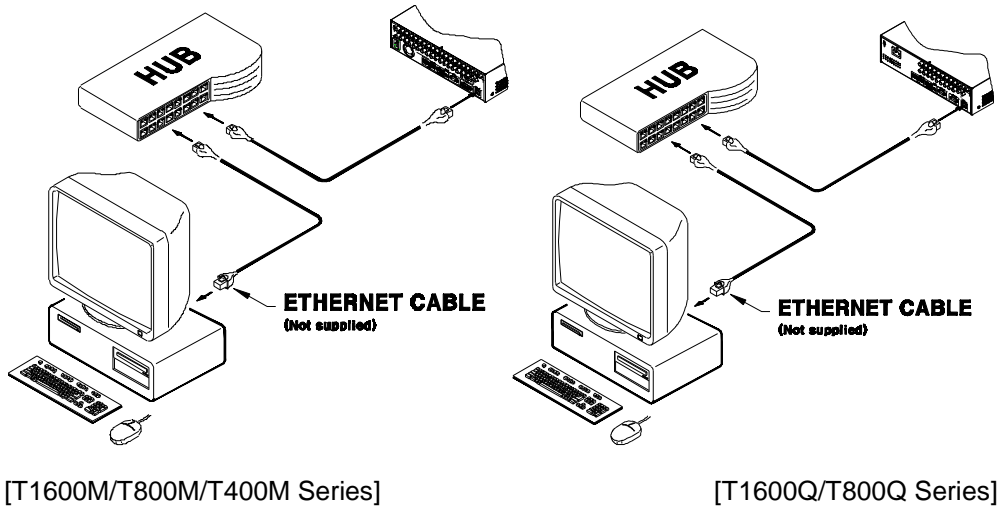

- (1) Cut Power.
- (2) Connet Ethernet cable to DVR and Hub.
- (3) Input Power.

#### <Reference>

To protect DVR damage, after connecting Ethernet cable, input Power.

Please, check Ethernet cable connection firmly.

Input power on DVR and check their connectivity.

### 2.3.5.2 Network configuration



### **Ethernet**

Set type as Ethernet and input IP, Netmask, Gateway, DNS.

The way to input is using directional key or mouse wheel.

### **PPPoE**

Set type xDSL, and move to xDSL menu.

First, change Ethernet Port

Please, input ID and Password for PPPoE.

### **WRS**

After changing interval over 1 min, register WRS address and product and input Group ID.

# User Manual

## 3 Menu Use

### 3.1 Menu Structure

The menu structure will be shown like below image, and each menu setting method described from chapter 4 to chapter 6.

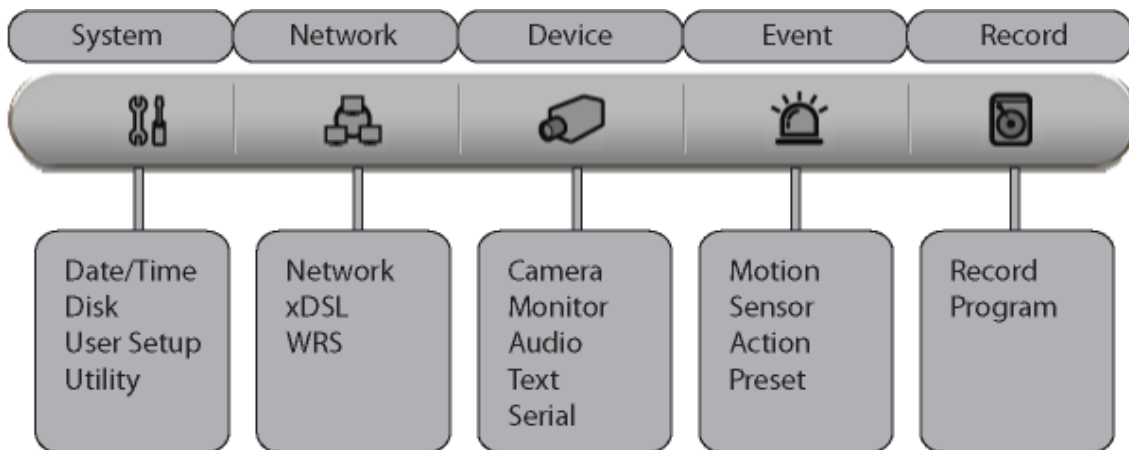

### 3.2 Function Menu

To execute Function menu, click the right button of mouse or select 'FUNC' button on front panel. The Function menu can be controlled by mouse.

Each function can be executed by clicking right button of mouse and click desired icon.

The Function menu also can be controlled by front part of DVR's buttons.

Please refer to below picture for the Function menu structure.



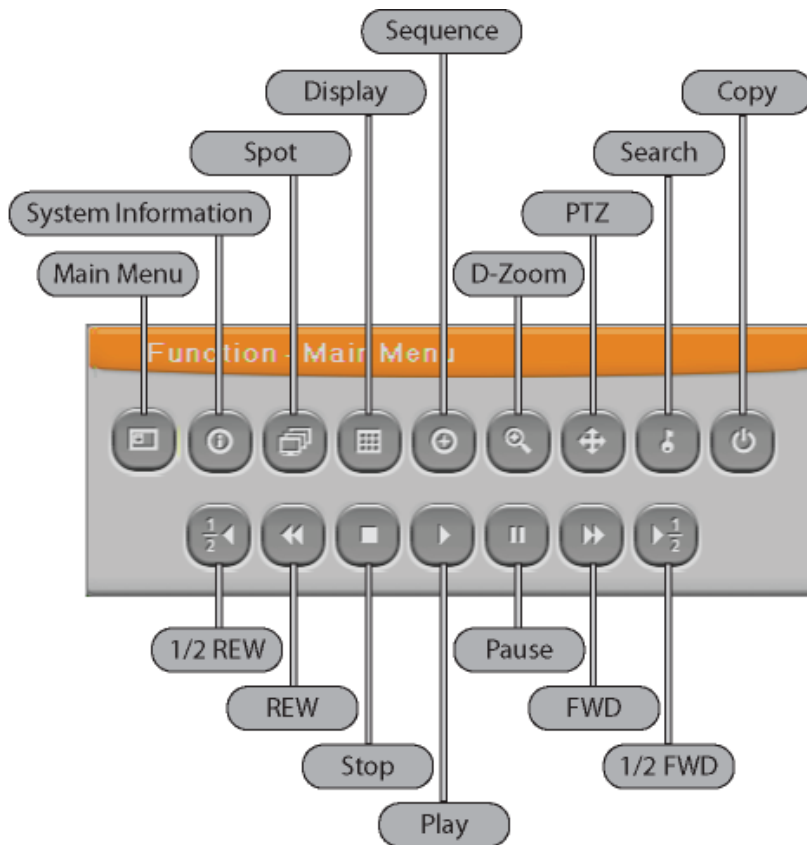

### 3.3 Factory Reset

In order to reset value to factory value, go to System Setting->System->Setting, and once press Factory Reset then the warning message will be appear, click "Yes" to reset the DVR value to factory.

#### Default Value from Factory

System			
Date Time	Time Zone		UTC 00:00 Dublin
	Daylight Saving		Off
	NTP Function		Korean
		Sync With NTP	Off
		NTP Mode	Client
		NTP Server Loc.	Public
		NTP Local Server IP	0.0.0.0
		Interval	1(hour)

	Holiday Select		UTC 00:00 Dublin
	Date Format		No
	Time		MM/DD/YYYY
Disk	Over Write(Auto Deletion)		On
	Block Playback		Off
	Disk Full Alarm Warning		50°C
	Disk Manager		>>
	Disk Status		>>
User Setup			No Password used
Utility	DVR Alias		DVR0
	DVR Keyboard ID		1
	Remote Controller ID		All
	Language		English
	Firmware Update		>>
	System Log		>>
	Factory Reset		>>
<b>Network</b>			
Network	Type		Ethernet
	DHCP		Off
	IP addr		Default IP
	Net Mask		Default Net Mask
	Gateway		Default Gateway
	DNS1		0.0.0.0
	Additional DNS		>>
	Port		80
	Band Width Limit(Mbps)		0.0
xDSL	User ID		Guest
	Password		*****
	Status		xDSL not connected
WRS	Interval		Off
	URL		www.webgateinc.com

	Group		Newbie
	Status		Not Registerd
<b>Device</b>			
Camera	Camera Number		Ch1
	Name		Cam 1
	Status		On
	Type		NTSC
	Color		Color
	AGC		Enable
	Bright		0
	Contrast		0
	PTZ	PTZ Home	Off
		PTZ Idle Time	5
		PTZ Port	None
	PTZ Address	0	
Monitor	Monitor		
	Alarm Pop-up(Sec)		Off
	User Sequence Configuration		<<
	SEQ Time(Sec)		5
	Covert		>>
	Multi Moce		4E, >>
	VGA Mode		800x600@56Hz
	Infor Level		>>
Audio	Audio Channel		
	Audio Recording		
	Audio Gain		
	Sync Video Channel		
	Audio Mix		
Text	Recording		Off
	Sync Test With		Ch1
	Device		Manual
	Seek Header		Off
	Header 1		Header1
	Header 2		Header2

	Delimiter		0D0A
	Timeout(ms)		1000
	Lines		20
Serial	Serial Port		Com1
	Device		Non
	Interface		RS232
	Baud Rate		9600
	Parity Bit		None
	Stop Bit		1
	Data Bit		8
<b>Event</b>			
Event	Event Check		Always
	Event Action		Relay1
	Action Duration		10 Sec
	Normal Event Source		>>
	System Event Source		>>
Motion	MD		All
	Sensivity		2
	Area		Set All
Sensor	Sensor		All, N.O.
Preset	Channel Mumber		Ch1
	Preset		Sensor1, Preset1
<b>Record</b>			
Record	Record Mode		Manual & Event
	Program		ProgramK
	Event Duration		>>
	Playback Deinterlace		On
Program	Normal	Resolution	All D1
		Frame Rate	All 6
		Quality	All Q5
	Event	Resolution	All D1
		Frame Rate	All 6
		Quality	All Q5

**Program initial value**

**HVRM-T800Q**

Record mode		Normal			Event		
Division		Res	Fps	Q	Res	Fps	Q
Program	A	D1	7	Q5	D1	7	Q5
	B	D1	4	Q5	D1	4	Q5
	C	D1	2	Q5	D1	2	Q5
	D	Half	15	Q5	Half	15	Q5
	E	Half	7	Q5	Half	7	Q5
	F	Half	4	Q5	Half	4	Q5
	G	CIF	30	Q5	CIF	30	Q5
	H	CIF	15	Q5	CIF	15	Q5
	I	CIF	7	Q5	CIF	7	Q5

**HVRM-T1600Q**

Record mode		Normal			Event		
Division		Res	Fps	Q	Res	Fps	Q
Program	A	D1	4	Q5	D1	4	Q5
	B	D1	2	Q5	D1	2	Q5
	C	D1	1	Q5	D1	1	Q5
	D	Half	7	Q5	Half	7	Q5
	E	Half	4	Q5	Half	4	Q5
	F	Half	2	Q5	Half	2	Q5
	G	CIF	15	Q5	CIF	15	Q5
	H	CIF	7	Q5	CIF	7	Q5
	I	CIF	4	Q5	CIF	4	Q5

**HVRM-T400M**

Record mode		Normal			Event		
Division		Res	Fps	Q	Res	Fps	Q
Program	A	D1	30	Q5	D1	30	Q5
	B	D1	15	Q5	D1	15	Q5
	C	D1	7	Q5	D1	7	Q5
	D	Half	30	Q5	Half	30	Q5

	E	Half	15	Q5	Half	15	Q5
	F	Half	7	Q5	Half	7	Q5
	G	CIF	30	Q5	CIF	30	Q5
	H	CIF	15	Q5	CIF	15	Q5
	I	CIF	7	Q5	CIF	7	Q5

**HVRM-T800M**

Record mode		Normal			Event		
Division		Res	Fps	Q	Res	Fps	Q
Program	A	D1	15	Q5	D1	15	Q5
	B	D1	7	Q5	D1	7	Q5
	C	D1	4	Q5	D1	4	Q5
	D	Half	30	Q5	Half	30	Q5
	E	Half	15	Q5	Half	15	Q5
	F	Half	7	Q5	Half	7	Q5
	G	CIF	30	Q5	CIF	30	Q5
	H	CIF	15	Q5	CIF	15	Q5
	I	CIF	7	Q5	CIF	7	Q5

**HVRM-T1600M**

Record mode		Normal			Event		
Division		Res	Fps	Q	Res	Fps	Q
Program	A	D1	7	Q5	D1	7	Q5
	B	D1	4	Q5	D1	4	Q5
	C	D1	2	Q5	D1	2	Q5
	D	Half	15	Q5	Half	15	Q5
	E	Half	7	Q5	Half	7	Q5
	F	Half	4	Q5	Half	4	Q5
	G	CIF	30	Q5	CIF	30	Q5
	H	CIF	15	Q5	CIF	15	Q5
	I	CIF	7	Q5	CIF	7	Q5

## 4 Monitoring

All analog video image channels connected to eDVR is displayed to screen by Power connection. It is to utilize all monitoring mode of DVR.

### 4.1 Basic Screen

After Power connection, the DVR operates on automatically.

It boots with LED on.

After booting, 16 channel screens are displayed.(HVRM-T1600M, HVRM-T1600Q : 16screens,  
HVRM-T800M,HVRM-T800Q:9screens, HVRM-T400M: 4screens)

※ If there is user password set, Password input window will be displayed.



### 4.2 Single Full Screen Mode

Press the channel number wanted or click mouse button.

Press [MULTI] button to return to divisional screen.

### 4.3 Multi Screen Mode

Press [MULTI] for multi channel display or click "Display" icon from Function menu.

Press [MULTI] button every time, screen mode for HVRM-T1600M, HVRM-T1600Q is changed to 1~4, 5~8, 9~12, 13~16, 4C, 1~9, 8~16, 1~10, 16 screens, and for HVRM-T800M, HVRM-T800Q is 1~4, 5~8, 4C, 9screens, and for HVRM-T400M is 1~4screens.

4A, 4B, 4C, 4E, 9A, 9B, 10A, 16 channel division. (MD800E : 4E, MD400E : not supported).



## 4.4 Screen Description

The status bar from monitoring screen, it shows DVR's current status that included Date/Time, Record, Motion/Sensor Detection, Manual Record, Text input and HDD's record capacity.

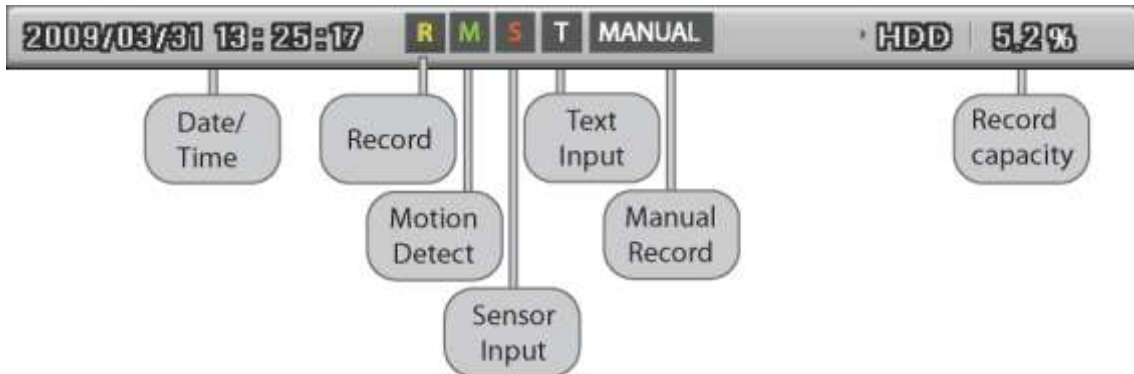

## 4.5 Auto Switch Mode

There are System Standard modes and User Defined mode in Auto Switch mode. And Users Sequence mode operates by the press [SEQ] button.

### 4.5.1 System Standard Mode

By [Auto] button, it can monitor auto switching of all channels.

Press [MENU] for the setting switching term or using mouse click menu icon from function menu.

Move to "Device" → "Monitor" from OSD menu.

Select "Seq. Switching(sec)" and set value from 1 sec. to 60 sec. At OFF set, auto switch mode does not operate.







Auto Switch mode can be set in every division mode by the press [Auto] button.  
 Press [Auto] button once more to leave from Auto Switch mode.

#### 4.5.2 User Sequence Mode

Press [AUTO] button or click [Sequence] icon from Function menu with mouse.

- Auto Switch model can be set from "Monitor" main menu.





User mode can define max. 16 channels.

As shown above picture, the 16ch DVR can be define between channel 1 ~ 16, the 8ch DVR from 1 ~ 8 and the 4ch DVR from 1 ~4.

## 4.6 Event Screen

When there is an event occurred, the green color [M] and red color [S] will be display from status bar. In case of [M] displayed, the camera name will be turned to green color, and it will turn to yellow when Motion Detection event finish.

In case of [S] displayed, the camera name will be turned to red color, and it will turn to yellow when Sensor event finish.

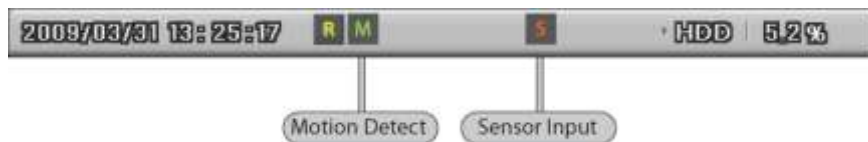

It can be set to Pop-up automatically relevant screen when alarming.

Set pop-up period can be set into "Alarm Pop-up (sec)" inferior to "Monitor" menu.

At the simultaneous alarming in several channels, it displays the division as many channel as alarmed. For example, when 3 channels alarm, 4 divisions is displayed on screen. And press any button to return original channel.



1. If Alarm Pop-up Hold (sec) set to Off, Alarm Pop-up will not operate.
2. If Alarm Pop-up Hold (sec) set to Keep, it does not return to previous screen before press any button

#### 4.7 Zoom Screen Mode



- From single full screen mode, press [FUNC] and D-Zoom button then select + button to activate zooming the image.
- Default zoom screen locates to main center when press [ZOOM] button. Zoom image can shift left-right in 18 steps and top-bottom in 12 steps.
- Use directional key button to screen move.
- Press [-] one more to return to original screen.

#### 4.8 Pause Live Screen

- Live screen can pause like PlayBack.
- Press [PAUSE] to pause live screen and press [PAUSE] to return live screen.

## 4.9 PTZ Control

Connect PTZ controller to DVR and set relevant protocol from “Serial Setup” menu, then PTZ can operate while monitoring live images.

The method of operating PTZ, press PTZ button from DVR’s front panel, or click PTZ icon from Function menu.

Below lists are the protocol available in DVR.



Model	Manufacturer
BOSCH AutoDome, TC8560X-4	Bosch
PELCO(P), PELCO(D)	Pelco
Sony EVI-D3x	Sony
VT VPT-4x	VT
AD SpeedDome	AD
SungJin SJ372R1	SungJin
Samsung SCC641	Samsung Electric
Panasonic WV-CS850	Panasonic
SDZ160/330, Samsung SPD, Keyboard SCC3000A, Samsung SRX-100B	Samsung Techwin
LG GAC-PT2	LG
Keyboard KBD300A, WGI SPD1800/2600	Webgate
WKC-100	Webgate
Merit-Lilin FastDome	Merit
Elmo PTC200C	Elmo
Canon VC-C4	Canon
HTC-230S	DongYang Unitech
RVision	RVision
Elbex	Elbex
Honeywell 755/655, HRX-2000, HTX-3000, ScanDome2	Honeywell
VIDO	VIDO
VICON	Vicon
Hunt	Hunt
ORX-1000	Systemenia

Fine CRR-1600	LiveEye
Tokina	Tokina
Kodicom KRE	Kodicom
Nuvico	Nuvico

- Press desired channel button.
- Press PTZ button from front panel or click PTZ icon from function menu with mouse.
- PTZ menu (Pan/Tilt, Zoom/Focus, Load Preset, Save Preset) will be appear.
- Then press [Enter] button or click from mouse.

#### 4.9.1 Pan/Tilt

This menu is used to control Pan & Tilt function at real-time monitoring mode.

- Select Pan/Tilt from PTZ mode.
- Control Pan/Tilt through directional key at front part.

#### 4.9.2 Zoom/Focus

This menu is used to control Zoom & Focus function at real-time monitoring mode.

- Select Zoom/Focus from PTZ mode.
- Control Pan/Tilt through directional key at front part.

#### 4.9.3 Load Preset

This menu is used to shift to Preset Set at real-time monitoring mode.

- Using up / down button or mouse wheel to select the Preset Number.
- Once preset configured then select Load and press Enter or click from mouse.

#### 4.9.4 Save Preset

This menu is used to set new Preset at real-time monitoring mode.

- Control camera location using 'Pan/Tilt' and 'Zoom/Focus' menu.
- Using up / down button or mouse wheel to select the Preset Number.
- Once preset configured then select Save and press Enter or click from mouse.

#### 4.9.5 Auxiliary On

This menu is used to utilize specific function in PTZ device at real-time monitoring mode.

- Using up / down button or mouse wheel to select the Aux Number.
- Press relevant Number button of specific function (Aux function is available to max 16 functions.)

### **4.9.6 Auxiliary Off**

This menu is used to stop operation of specific function of PTZ device.

- Using up / down button or mouse wheel to select the Aux Number.
- Select Off and press Enter button or click from mouse.

### **4.9.7 Menu**

It is to go into connected PTZ's menu, using up/down/left/right and enter key from front panel for setting the menu, and press ESC button for exit the menu.

# 5 Playback

## 5.1 Playback Mode

### 5.1.1 Playback on Standard monitor (16 / 9 / 4 division)

- Please, push play button in monitoring mode or mouse click play button in Function menu.
- If pushing Play button or FWD button, video playbacks in forward direction at 1x speed.
- If pushing REW button, video playbacks in reverse direction at 1x speed.
- If pushing Playback button in multi-division monitor mode, it playbacks the recorded data as 16 / 9 / 4 division screen.

### 5.1.2 Playback function

**PLAY** : Playback 1x speed. If using mouse, click Play button in Function menu.

Multi channel video will play back if pushing [PLAY] button in monitor mode. And it playbacks from the latest played back.

**PAUSE** : Pause playback temporary. With mouse, click Pause button in Function menu.

**STOP** : Stop playback. With mouse, click Stop button in Function menu.

**FWD** : Playback speed will be changed. (x1, x2, x4, x8, x16, x32, x64, x1/2, x1, x2, x4 – in order), If pushing [FWD] button in live view, it plays back video 1 minute ago. Playback speed can be changed by pushing [FWD] button.

**REW** : Reverse playback speed will be changed. (x1, x2, x4, x8, x16, x32, x64, x1/2, x1, x2, x4 in order)

If pushing [REW] button in live view, it plays back video 1 minute ago. Playback speed can be changed by pushing [REW] button.

**STEP FORWARD** : If pushing [FWD] button on Pause mode, playback by each frame to the forward. Push [PLAY] to return normal playback.

**STEP REWIND** : If pushing [REW] button on Pause mode, playback by each frame to the reverse. Push [PLAY] to return normal playback.

**1/2 REWIND** : Play back at a half speed to forward direction.

**1/2 FORWARD** : Play back at a half speed to reverse direction.

## 5.2 SEARCH MODE

This menu is to playback specific time data from the time frame and searching log at Playback mode.

There are Time, Calendar, Event, Thumbnail mode.

Please, push Search button on the front panel or click in Function menu.



### 5.2.1 Time Search

Select date and time to search and playback video will be moved to the selected point.



- Start-REC Time** : The date and time of start-recording
- End-REC Time** : The latest date and time of the recording
- Search Time** : Select the range of date and time for Search
- Search** : Execution button

### 5.2.2 Schedule Search



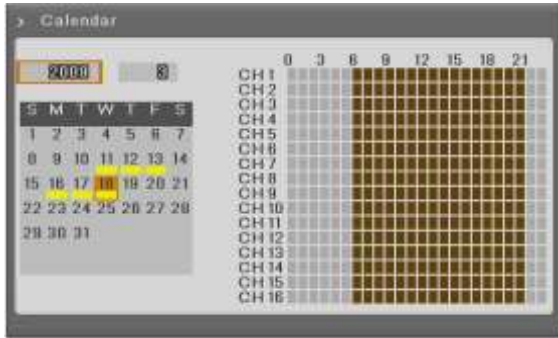

HVRM-T1600M, HVRM-T1600Q

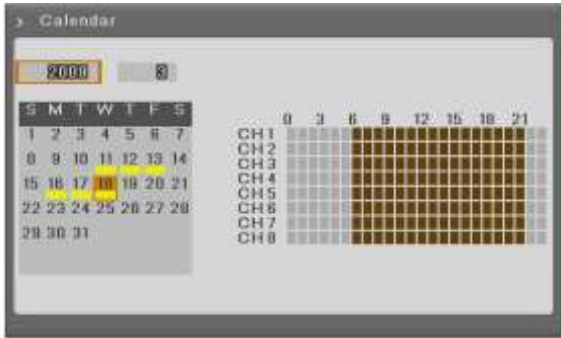

HVRM-T800M, HVRM-

T800Q

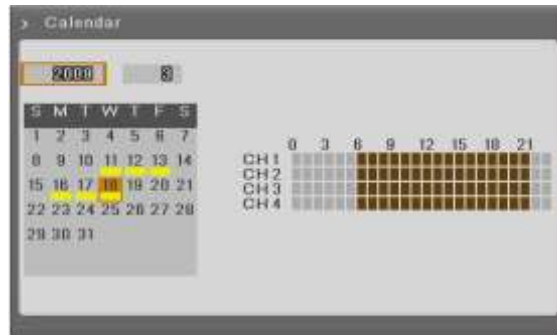

HVRM-T400M

Depends on models, HVRM-T1600M, HVRM-T1600Q shows the status of recording for 1~16ch, HVRM-T800M, HVRM-T800Q for 1 ~ 8ch, HVRM-T400M for 1~4ch.

- Year** : Select Year to search. With mouse wheel, user can change it.
- Month** : Select Month to search. With mouse wheel, user can change it.
- Date** : Select Date to search. With mouse, select the date and decide the time by wheel.
- Time** : Select the time and push Enter button to play back.

### 5.2.3 Event Search

User can search by all channels, some of channels, all events, motion detection, sensor in certain range. For change of date and time, with front panel, please use top and down button. In case of using mouse, scroll the mouse wheel after selecting area. Searched result will be displayed on additional event window. Select and push enter or scroll the mouse wheel to move to the wanted date and time area.



- Start-REC Time** : Starting date and time of the recording.
- End-REC Time** : The latest date and time of the recording
- Search Start Time** : Input start date and time for search with direction button and push Enter and change the value by Up and Down button. With mouse, click and scroll the wheel.
- Search end Time** : Input end date and time for search with direction button and push Enter and change the value by Up and Down button. With mouse, click and scroll the wheel.
- Event Channel** : Select the channel for search  
 HVRM-T1600M, HVRM-T1600Q from Ch1 to Ch16  
 HVRM-T800M, HVRM-T800Q from Ch1 to Ch8  
 HVRM-T400M from Ch1 to Ch4
- Event Type** : Select the event type for search  
 There are all events, motion detection,sensor, video loss, text type

### 5.2.4 Thumbnail Search

Search certain channel by thumbnail type. If select the searched thumbnail, selected date and time video will be played back.



- Channel** : Select the channel and change the value by direction key or mouse wheel.

- Start Time** : Input the date and time for starting search and change the value using up-down direction key or mouse wheel.
- Interval** : Set Interval value by Up-down button or mouse wheel.
- View video** : If pushing search button, 16 cycles will be shown based on start time. Press [Func] to return to the search or use mouse wheel.
- Select video** : Play back from the selected video of thumbnail search result. With pressing Enter or clicking mouse, use can play back.

### 5.3 Copy

This is for copying recorded video. There are CD/DVD and RE4 and AVI type.

Copy function is supported to be used by user who has the authorization. For authority configuration, please, refer to 6.9.3 Security.

To use copy function, press [COPY] or Click Copy button in Function menu.

In case to copy with RE4 and AVI format, you need to use USB memory stick or USB HDD.

You must do "Fat32" format first from PC before doing copy.

#### 5.3.1 CD/DVD

This is copy function by using CD or DVD. CD or DVD will be automatically searched.



- Type** : Selec CD/DVD using up-down direction key or mouse wheel. Press Enter and scroll wheel to change the value.
- Channel** : User can select some or all channel among 16channels. Select the channel location and press Enter or use mouse wheel.
- From** : Select start date and time to copy using up-down key or mouse wheel.
- To** : Select end date and time to copy using up-down key or mouse wheel.

- Select Disk** : Select the media to copy using Enter button on Select Disk.
- Start** : Start Copy. Press Start button with Enter or click the left button of the mouse.

Please, refer to the supported media list below.

DVD-R manufacturer	CD-R Manufacturer
Mitsubishi(x16 recommended)	Mitsubishi(x52 recommended)
TDK(x16 recommended)	TDK(x52 recommended)
Imation(x16 recommended)	Imation(x52 recommended)
Sony(x16 recommended)	Sony(x48 recommended)

### 5.3.2 RE4



User can back up by HDD, USB memory and play back using mini-player or Control Center. Select channel position and press Enter or use mouse wheel to open the channel list like below.



[HVRM-T1600M, HVRM-T1600Q]

[HVRM-T800M, HVRM-T800Q]

[HVRM-T400M]

- Type** : Select RE4 using up-down button or mouse wheel.
- Channel** : To pop up the channel selection window, press Enter or use mouse wheel.
- Select Channel** : use can select some or all channels and after selecting channel, press Enter or click mouse left button.

- Start time** : Set start date or time to copy. After selecting part for change and set the vaule using up-down key or mouse wheel.
- End time** : Set End date or time to copy. After selecting part for change and set the vaule using up-down key or mouse wheel.
- Select disk** : Select media to copy. Press Enter on Disk list or click mouse.
- Start** : Start copy. Press Enter or click mouse.

**Reference : not perfectly finished backup file will not be played back in PC.**

### 5.3.3 AVI

Use USB memory or HDD to copy certain part.



- Type** : Select AVI using up-down key or mouse wheel.
- Channel** : Select the channel to copy by up-down key or mouse wheel.
- From** : Set start date and time to copy. Time and Year by left/right button and date/time by up/down button. With mouse, click left button first and use wheel.
- Duration** : Set copy length. Copy as selected time length from the start using up/down key or mouse wheel.
- Select disk** : Select media to copy. Press Enter and select media or click mouse.
- Start** : Start copy. Press Enter or click mouse.

**Caution : If copied file is not played back, please, install integrated codec first.**

## 6. Configuration

### 6.1 Recording Structure

There are 4 modes in DVR recording. Configuration relation structure is like below.

Please, refer to the below each item for detailed recording configuration.

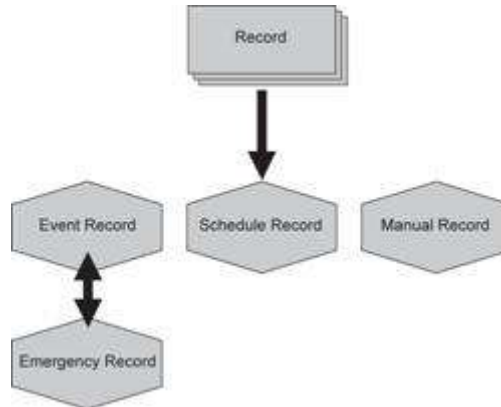

### 6.2 System Setup

Time and Disk and authority can be configured.

#### 6.2.1 Date/Time

Time set should be configured prior to the recording.



Time configuration is very important to protect the recording data. Time change on recording is not recommended. Time zone configuration value of factory default is "UTC 00:00 Dublin"

### 6.2.1.1 Time Setup

**Caution:** under recording, if user changes Time, it will affect time change on previously recorded video data in accordance with. Therefore, we recommend backup before time change.

- Press Main Menu of Function or [MENU] button on the front panel.
- Move to “quick setup” menu.
- After selecting “Time” in Quick setup and press [Enter] or click.
- Menu of time configuration 6.2 will be opened
- To move to the sub menu, use directional key or mouse.

#### **Time zone**

Use left/right direction key or mouse wheel. To return to previous menu, press [ESC] or click right mouse button. (It is same as OSD menu)

#### **Daylight saving**

This menu is synchronized with time zone configuration menu. It means when daylight saving area is set, this function works. Daylight saving applicable area is all the same with Time zone of Micorsoft Windows.

#### **Date format**

With using left/right diection key or mouse wheel, configure date among “MM/DD/YYYY”, “YYYY/MM/DD”, “DD/MM/YYYY”.

#### **Time**

With left/right direction key, use can move to year,month,day,hour in order and each configuration will be controlled by up/down key or mouse wheel.

#### **Apply**

User must push “Appl Date/Time” button. And you will see the below message box.



**<Caution>**

Except date/time configuration, other configuration records automatically, but “date/time” configuration influences critical effect to HDD recording file system, It doesn’t record automatically. To apply the changed value, user must press [apply] button.

**6.2.1.2 NTP Setup**

NTP(Network Time Protocol) make time of connected devices synchronized. There are NTP server and client which get time signal from the server.



**Sync NTP**

Set NTP function on/off.

**NTP Mode**

Configure NTP mode of DVR – Client / Server / All

**NTP Server Loc.**

When NTP mode is client, it is on Enable. Configure yes or no whether NTP server is in Local Network or Public.



**NTP Local server IP**

In NTP local server Enable, configure server ip. Input IP address of NTP server or DVR set by NTP server In local network.

**Interval**

Configure interval of time sync.

**Caution: If use NTP client mode, user must set NTP on.**

**6.2.2 Disk**

It explains how to add or remove or format internal or external HDD.



**Over Write(Auto Deletion)**

If there is no space in HDD, old data will be deleted automatically.

**Block Playback**



This function makes recording data seen during the limited area.

For instance, if setting block playback by 2 day(Pic 2) among 10 days, Just allowed 2 days data can be played back.

**Disk Full Alarm Warning**

If mounted Disk is full, alarm warning to user.

### 6.2.2.1 Disk

This is menu for the management of internal or external HDD.

Manage status, bad block, size, Yes or No etc.



**Type** : display location or type of disk.

Int A (Internal A HDD), Int B (Internal B HDD), Ext (External HDD)

**Model** : HDD model name.

**Bad Blk** : display bad block. In HDD. If no problem, "0" will be displayed. Others are Not shown anything at all.

**Size** : Display HDD size by MB unit

**Enabled** : Make HDD enable mode or disable mode.

Yes: enable / No: Disable

#### In case HDD YES

- **Enabled** : Press [Enter] in No mode or scroll mouse wheel. Notice window pops up and show user the message like below.
- Caution : This Disk is not available without format. Will you format Disk?
- If selecting **No**, keep previous data and HDD will be Enable to use.
- If selecting Yes, delete previous data and HDD will be Enable to use.

#### In case HDD No

- **Enabled** : In Yes mode, press [Enter] or scroll mouse wheel and notice window pops up and show user the message like below.
- Caution, will you remove Disk?
- If **Yes**, user will find the message "Disk is removed" on the bottom and Enable status will be **No**.

- HDD is not used.
- If No, keep previous HDD without change.

### 6.2.2.2 Disk Status

Temperature and status of HDD will be shown.



### 6.2.3 User Setup

There are administrator and user and administrator can use all functions. The max. number of user is 10 person. Each user can use the function allowed.

#### Check

If Check item is configured all by X[Check-1], all users can use all functions.



[Check-1]

[Check-2]

In the other hand, if all are set by O[check-2], all users can use the functions in accordance with Each users authority.

For example, as you can see the below picture, User1 can use PTZ, Relay off, power On, N/mike functions are available, user 2 just can use menu and N/mike functions.



<Reference>

Admin Password is “12345” in factory default and from user 1 to 10 in order “11111”, “22222”, .. and user10 is “00000”. In case of 9 channel DVR user, press “0” for figure 0, in case of 16 channel, press button “10”

Password change



Select user → Input password and press change → Press Yes  
 Password input box is displayed. Password can be input with front figure button or text input window. After inputting 8 digit figure, click “Change” button.  
 After that, message pop up window will be shown and press “Yes”.

Authority

User can use only authorized functions.  
 If user 1 has PTZ use authority, when pushing PTZ button, authority check window will pop up and user should input the password and if it is correct, user 1 can use PTZ function. If password is wrong, message box “Wrong password” will be displayed.



[Authority Check]



[Wrong password message]

## 6.2.4 Utility

Configure the name of DVR, remote controller ID, Language.



### DVR Alias

Set the name of DVR.

### DVR Keyboard ID

This menu is to set the address of keyboard when using all functions of DVR by keyboard. Factory default is "1". If user want to control various DVR by one keyboard, its address should

be set with the different value.

### Remote Controller ID

Max 16 remote controller ID can be set and one remote controller can manage 16 DVRs.

Registration order for Remote controller.

- Make remote controller direction to DVR.
- Press ID button and figure in accordance with configured remote controller ID.
- If IDs are matched correctly, DVR buzzes.
- Use Remote controller.

### Language

Select Language to use.

### Firmware Update

Can update firmware by USB Memory.

- Insert USB memory to USB port.
- Press Firmware Update button.
- Select [YES] on the pop up window.



- System will reboot.
- Firmware update is done.

### System Log

System Log shows boot status of system and user and configuration etc.

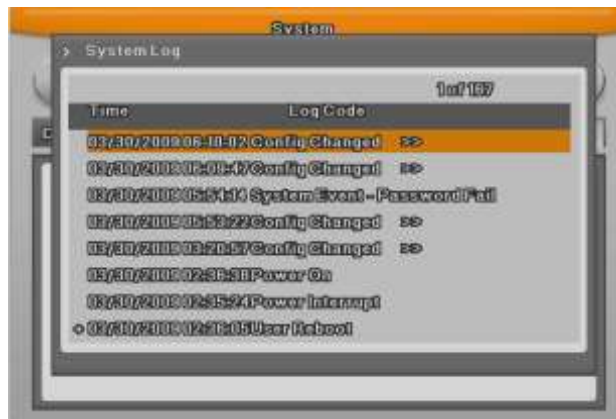

### Factory Reset

Change all configuration value by factory default.



Caution : Only administrator is allowed.

## 6.3 Network

This is menu for configuring network.



### **Type**

Configure type of Network (Ethernet/xDSL). If connected to cable modem or Lan directly to DVR, configure by "Ethernet".

If DVR connects to xDSL- one of PPPoE type, configure xDSL. But if it is not type of PPPoE, configure 'Etherent'.

### **DHCP**

With DHCP (Dynamic Host Configuration Protocol), all hosts connected to Lan can get Public IP address temporary.

If LAN has DHCP server and it is active, DHCP server allocate IP address to DVR.

Mostly middle and large network use DHCP server in LAN, but in case of small network, NAT(Network Address Translation) of HUB is general.

### **IP Addr**

IP Address is for the connection between DVR and Control Center and also for web connection from Webviewer. (But, Net Mask, Gateway should be configured.)

### **Net Mask**

Net Mask makes range of IP address available. It should be received from network administrator.

### **Gateway**

Gateway is necessary to communicate IP, it should be received from network administrator.

### **DNS1**

DNS1 is mandatory item to regist and use SWR and it should be asked to network administrator.

### **Additional DNS**

Additional DNS is alternative when DNS1 has a problem.

### **Port**

Port is necessary for Control Center and Webviewer connection.

**Reference : Basic port is 80 and if using PPPoE modem and AP, be careful typing port number.**



## Bandwidth

Menu for configuring network data transmission capacity. Without any additional configuration, it works but if user want to set, please, ask for administrator.

### 6.3.1 xDSL

DVR is connected to xDSL line and use PPPoE type, please change type by xDSL and configure user ID and Password. User ID and Password should be same as xDSL.



#### User ID/Passwod

Configure user ID and Password.

#### Status

It shows connection status of DVR.

### 6.3.2 WRS

If eDVR is connected to Cable modem or xDSL modem, IP address is changed at every connection to ISP. In this case, changed IP address can not be known. If eDVR using static IP register into WRS server, changed IP address can be known easily when it connects to eDVR.

***To register Static IP to WRS, please refer the following to set.***



### WRS Interval

For continuous registry, register interval should be set to 'WRS Interval'. According to set value of static IP address, it renews the information in WRS server regularly. If user registers the interval '0' or eDVR does not transmit any data for 2 days, the data is removed from WRS.

### WRS URL

This menu is to set server address to register. WRS addresses that WebGate operates now are [www.webgateinc.com](http://www.webgateinc.com) or [mycam.to](http://mycam.to).

## 6.4 Device Setup

This menu is for configuring each camera connected to DVR.

There are [name][Status][Color/balck or white][Brightness][Contrast][PTZ] etc.

**Caution : NTSC and PAL camera can not be used at the same time.**

**If changing the camera from NTSC to PAL, system should be rebooted.**

Configured value will be applied to monitoring and search at the same.



## 6.4.1 Camera Setup

Select the camera to configure in Channel menu.

### 6.4.1.1 Title

Configure camera name.

If pressing [Enter] button or click mouse, test menu will be shown.

For text string, text input box will be shown.



- Use directional key for text input.
- With mouse, just click the text.
- Select the text using up/down and left/right button.
- After selecting the text, press [Enter].
- To delete the text, press [←] button.
- To make a space between letters, press [→].

### 6.4.1.2 Using Channel

Configure whether using camera or not.

After pressing [Enter], select it using left/right key or mouse wheel.

If user wants to enhance the recording or network monitoring speed, please, set the channel disable.

### 6.4.1.3 AGC (Auto Gain Control)

AGC is the function to control the range of video signal input from camera connected.

Configure Enable/Disable using directional key or mouse wheel.

### 6.4.1.4 Brightness/Contrast

It can control Brightness and Contrast of video. After press [ENTER], use left/right button or mouse wheel to set the value wanted from “-9” to “+9”.

## 6.4.2 Monitor Setup



Main monitor provides all function which DVR supports and with spot monitor can use single channel conversion.

### Covert channel

With Covert menu, user can covert the channel in Live/Playback mode

In Covert menu, all channel list will be shown and press [Enter] button and click mouse to tick the channel. Checked channel will not show the video in Live/Playback.

### User sequence configuration

User sequence can be edited. There are 16 user sequence mode and its interval is from 1 to 60seconds.

### Multi mode

HVRM-T1600M, HVRM-T1600Q have predefined screen modes. 4E(4channels), 9B(basic 7 channels and additional 2 channels),10A(10 channels). In case of HVRM-T800M, HVRM-T800Q, it can use only 4E(4channels) and HVRM-T400M doesn't provide multi mode.

### The way to composing

The way to compose screen is selecting the target and after selecting right window and press [Enter] button or use mouse. If channel selection is down, press [ESC] button or click mouse light button.

### DVI Resolution

There are nine resolutions - 800 x 600@56Hz, 1024 x 768@60Hz, 1280 x 1024@60Hz, 1280 x 720@50Hz,1280 x 720@60Hz, 1920 x 1080p60, 1920 x 1080i50, 1920 x 1080i60, 1920 x 1080RB

### Display information

Display information is to configure which information will be shown on live view and playback view. In live view, time, channel name, event, recording status, HDD, remote controller ID, text can be set and in playback view, time, command, channel name, event, text can be configured.

### 6.4.3 Audio Setup

With this menu, user can configure Voice Channel, Audio recording, Volume, Synchronization, Mixing.



#### Voice Channel

Select audio to use

#### Recording

Configure yes or no of using audio recording. If no, audio will be out only in live view and if yes, Audio will be out in both view modes.

#### Volume

Configure volume by +, - direction

#### Synchronize Video Channel

Configure which channel is matched with the input audio. But this function is applied only on recording. Audio out in live view will be covered in Voice Mixing below. Default set is Audio no.1 to channel no.1.

#### Voice mixing



Select audio in live view. If setting by “All”, input audio will be out in every channels and if configured certain channel, input audio will be out on the selected channel only.

### 6.4.4 Text Setup

Configure Text in Device menu.



#### Recording

Set On/Off of recording against Text input

#### Sync Text with

Select channel to synchronize with text.

#### Header check

It has the various type of data input from the external device (Access Control, POS, ATM etc). Like VSI Pro, VSI Pro Hydra, Star Finger 007, it is not needed when the protocol of these device have implemented on the device. If not, this is the parameter to analyze how the one of data is constructed from the text data that is input continuously.

Namely, all data has the first and the end. Header indicates the information that already inserts to inform its starting. Therefore, Header information is defined here to acknowledge its starting

of a data. The reason of 2 Header is to detect maximum 2 data out because each device can output various datas.

**Delimiter**

Delimiter value can be different according to the manufacturer, please, refer to the product manual or seller.

**Time out**

Following lines defined here means maximum number of text line from one data. Even if there is standized data, there can be a short and long data. For example, there are 3 lines to write names on ATM. But some may need only First name & Last name to register. Which it means requires only 1 shorter than other ATM users. It is to decide the last line of the one data register as final complete data to save after an hour's consideration of register later because eDVR can not recognize it automatically.

**Lines**

Define how many lines will be shown.

**Caution : external device can not be recognized, please, ask to the seller.**

**6.4.5 Serial Setup**

DVR has 3 serial port. One is RS-232 and the other 2 ports are RS-485.



**Serial Port**

Select Serial port.

**Device**

Select the connected device.

**Interface**

Configure which interface user uses.

COM1 is to RS-232C, COM2, COM3 are to RS-485.

**Baud rate/Parity/Stop Bit/Data Bit**

In put suitable value according to external device.

**6.4.5.1 PTZ Setup**

Additional configuration for PTZ Address, PointPTZ



**PTZ Home**

Shift to Preset assigned if it has no movement in certain time while PTZ control.

**PTZ Idle Time**

If it has no movement during configured time, shift to PTZ Home.

**PTZ Port**

Select Port for PTZ

**PTZ Address**

Configure the address configured in PTZ.

**6.5 Event Setup**

There are 5 items such as event, Text, Sycn Event, Preset, System event.





### 6.5.1 Event Check

There are 3 items – Always, not apply, Timezon.

In case of Timezone, with similar configuration window like schedule, user can configure event per weekday/time.



- INDEX : Schedule configuration from 1 to 50
- Weekday
- Time
- Delete : delete INDEX

#### How to configure

If configuring INDEX,weekday,time, they are displayed on the table.

If clicking and selecting start time and end time of recording on the table, Index,weekday,time will be shown on the table.

#### How to delete

Select INDEX and click Delete button.

If clicking Delete button without selecting INDEX, previously selected INDEX will be deleted and from the latest INDEX, it will be deleted in order.

#### How to change

After selecting INDEX, change directly weekday,time.

### 6.5.2 Sync Event

Configuration for Event synchronization.



#### Event Action

There are 6 actions – relay 1 to 4, buzz, E-Mail.

#### Action Duration

Action Duration runs if relay and buzz are configured, and goes on during the configured time. E-mail works by configured time interval.

#### Normal Event Source

User can configure Sensor, motion detection, V-loss, Text.

Model	Sensor	MD	V-Loss	Text
HVRM-T1600M HVRM-T1600Q	16	16	16	1
HVRM-T800M HVRM-T800Q	8	8	8	1
HVRM-T400M	4	4	4	1



**System Event source**

System Event source can configure Bad block, Disk full, Fan error, authorization failure, WRS registration failure.



**E-Mail**

**E-mail address**

Input E-mail address to get event alarm by E-Mail.



**Sender Address**

Not mandatory but necessary for receiver to find out which DVR sends event.

**Including Picture**

In general event, when sensor, MD, V-loss events are generated, the event information and channel video will be sent to e-mail together.

But system event just send system event information.

### 6.5.3 Motion Detection

**Channel**

All or certain channel.

**Sensitivity**

Sensitivity can be configured from min.1 to max 10.

**Area**

Select detection area.

User can select all or certain channel.

**User Area**

When selecting per channel, it can be configured.

1 grid size is **22x15** and factory default value is All. If pushing user area, configuration window for detection area.



With direction key, select area and press [Enter] or click mouse. And press “ESC” button or click right mouse button, shift to the previous menu.

### 6.5.4 Sensor

This menu is to setup the existing sensor input and type of sensor.

HVRM-T1600M, HVRM-T1600Q have 16 inputs and HVRM-T800M, HVRM-T800Q have 8 inputs and HVRM-T400M has 4 inputs.

Sensor has 2 types, Normal Open(N.O.) and Normal Close(N.C.).



### 6.5.5 Preset

In PTZ function, make configured preset work according to sensor input.

Please, configure preset per PTZ.

After selecting channel in preset menu, select event to work preset.

Event can select sensor,MD,Text, its preset can be configured up to 16.



## 6.6 Recording setup

There are 3 mode for recording – schedule recording, manual recording, event recording.

Schedule recording records according to the configured schedule. And manual recording records via pushing “REC” button and event recording records when events are on.

### 6.6.1 Program setup

Using [Program], adjust frame rate and quality and resolution and configure recording program for Manual&Event&Schedule.



[HVRM-T1600M, HVRM-T1600Q]



[HVRM-T800M, HVRM-

T800Q]



[HVRM-T400M]

In event recording, one channel can record up to its max frame rate and if setting 2 channels as event recording, their recording frame rate will be adjusted automatically.

#### Program

There are 26 programs from A to Z composing recording quality and resolution per channel.

Please, refer to 3.5 programe configuration value.

#### CH (Channel)

Display the channel figure.

**R (Resolution)**

There are 3 resolutions - D1(704x480), Half D1(704x240), CIF(352x240)

**F (FPS)**

It means frame per second and can select 1 to 30fps. Max. frame can be changed according to the configuration.

**Q (Quality)**

There are 5 recording quality - Q5/Q4/Q3/Q2/Q1. Recommended quality for event recording is Q3.

**Max R/F**

Max R/F shows the number of frame available according to the selected resolution. For instance, if it is set by 30fps at CIF, it means that the channel can record up to 30frame at CIF resolution.

**Reference : how to calculate recording performance**

$$D1[704x480] = 2 \times \text{Half D1}[704x240] = 4 \times \text{CIF}[352x240]$$

**If 480 frame can be recorded at CIF resolution, instead of it, 240 frames at Half D1 and 120frames at D1 resolution are possible.**

- In case that the channel is configured as disable  
 Configuration method : Menu > camera configuration > channel : "Disable" – (the channel in gray)  
 For example, all channels can be configured as 30fps at CIF all the same. If one channel is configured as disable, system has resource available as much as 30fps at CIF. And if combining it with other 30fps at CIF, other channel can be configured as 30fps at Half D1.
- **In case that the channel is configured as 0 fps.**  
 Another channel can not use resource room as much as CIF 30fps. It is because the channel configured as 0 fps needs 2~3fps at least for network..

**Reference : the relation in between general recording and event recording.**

When Event is triggered, records event recording according to the configured value. Recording Performance of DVR depends on the product. For example, if MD1600E is set as manual recording at CIF 480fps and event recording at CIF 480fps, it can not be over CIF 480fps. Therefore, it should be configured within CIF at 480fps resource.

- Event configuration value on CIF 480fps  
 If you configure recording all channels at CIF 30fps, available event recording configuration is CIF 30fps, Half 15fps, D1 7 fps.



If you want to configure channel no.1 as D1 30fps, you should adjust the other channel recording configuration.

• On event recording of multi channel

With mulity channel event recording, if configured recording value is over the system max performance, general reconrding will keep their recording configuration and event recording will be balanced down equally.

### 6.6.2 Manual/Schedule recording setup

With the change of recording mode, manual recording or schedule recording can be at one's choic.

And their resolution , frame rate , quality will be in accordance with the program.

#### 6.6.2.1 Manual Recording

Only in manual & event recording, manual recording runs and when pressing [REC] button, recording starts. If you want schedule recording, recording mode should be Schedule & Event.

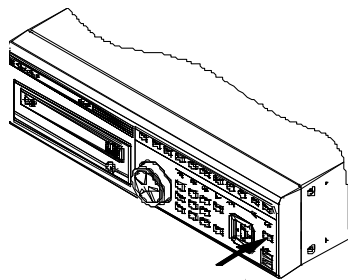

[T1600M/T800M/T400M Series]

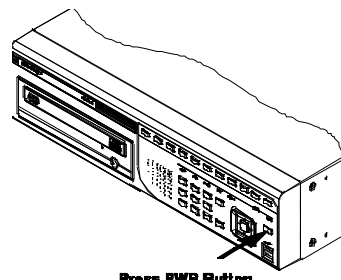

[T1600Q/T800Q Series]

#### 6.6.2.2 Schedule Setup

It records according to the programmed schedule automatically. Make recording mode Schedule & Event and configure day and time.



.check and select each program default vaule and select one of 26 program from A to Z or several programs. Below picture show program A.



- INDEX : Schedule unit from 1 to 50
- Weekday : Set the day applicable
- Program : Set recording program(A~Z)
- Time : Set time applicable
- Cancel : Cancel per INDEX

### Configuration

Configure INDEX, weekday, program, time.

If selecting recording start time and end time on the table by mouse, its Index,weekday,program will be displayed.

### Deletion

Select INDEX and click Delete button.

If clicking delete button without INDEX, previously selected INDEX will be deleted first and after that, from the largest INDEX in order.

**Edition**

Select INDEX to edit and change weekday, program,time directly.

In case that INDEX 50 are all configured, select the time zone to change by mouse click and click the time again, previous configuration will be deleted and new configuration will be shown.

**Caution : If selecting the same time twice, “!” will be shown on the chart.**

**When configuring time sector, previously configured time can not be included.**

**De-interlace**

Set playback deinterlace On/Off.

It works on Full Dq recording. In “On” status, screen vibration of paused Full D1 video will be reduced.

**6.6.2.3 Event recording setup**

Select resolution and frame rate and quality for event recording.

There are 4 triggers – Sensor, Motion detection, Text, Digital input.

First, select the program and check resolution and frame rate and quality of the channel.

(refer to 6.6.1, program configuration)

Event recording can syncro manual&event, Scheduel&Event.

Select among Manual&Event, Schedule&Event in “Recording mode” of [Record configuration]-[recording]



**Reference : Please, check below to configure event recording.**

- 1. Select one of Manual&Event, Schedule&Event.**
- 2. In program configuration, set frame rate by 0 fps in general mode and only configure Event frame rate.**

### 3. Set Event applying time.

#### Event Time configuration

Configure time for event recording and there are 3 mode – Always, no use, Timezone.

In “Always”, event works all the time and in “Timezone”, works during configured time.

Configuration of Timezone is similar with schedule configuration and can configure weekday,time for Event.



- INDEX : Set from 1 to 50
- Weekday : Set weekday applicable
- Time : Set time applicable
- Deletion :Delete per INDEX

#### Configuration

Configured INDEX,weekday,time will be shown at once.

Select recording start time and end time in order and its INDEX,weekday,time will be shown.

#### Deletion

Select INDEX and click Delete button

If clicking delete button without INDEX, previously selected INDEX will be deleted first and after that, from the largest INDEX in order.

#### Edition

Select INDEX to edit, and change the values.

In case of being configured by INDEX 50, click and select time to edit and if clicking the time table again, previous configuration will disappear and new configuration will be shown.

## 7. Web Viewer

WebViewer is Web application program loaded to monitor real-time image or to minitor the images recorded through Web browser to PC located remotely.

WebViewer is divided into Login page and Monitor to do monitoring real-time images, Playback to replay recorded images.

### 7.1 System requiriement

	Minimum	Recommendation
CPU	Intel Pentium 4 / 3.0GHz	Core2duo E6750 or higher
Main Memory	1GB	2GB or higher
Video Memory	128MB	512MB or higher
Display	1280 x 1024 (with 32bit color) or higher	
HDD	1GB or higher	
OS	Windows XP Professional(over SP2) / Window Vista Business( over SP1)	
Others	DirectX 9.0 or higher	

### 7.2 Login



After input IP address that set to system, then WebViewer Login page will be connected.

Input the set of User ID & Password, click 'LOGIN' to access.

If didn't change the password in Control Center, ID and Password will be admin/12345.  
ID can not be changed.

### 7.3 User Setup

To access WebViewer, user authority and password can be changed in DVR or Control Center configuration

In account menu, user password can be changed.

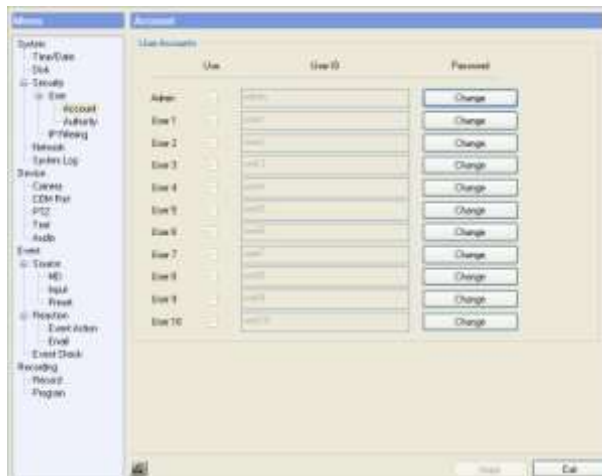

Basic admin password is "12345" and user password is like "11111{", "22222" ~~, user10 is "00000". Valid password is 5 digit.

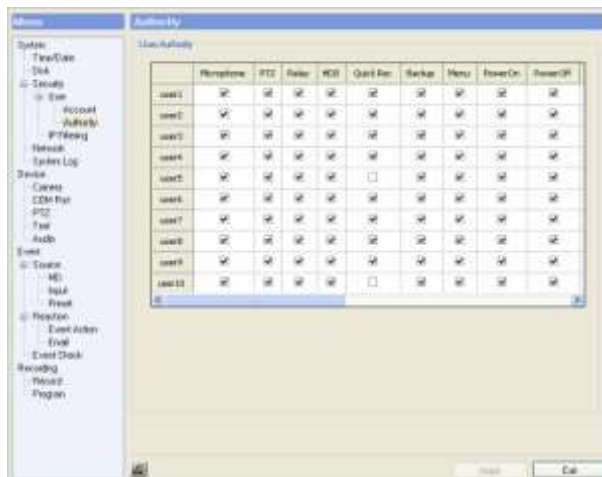

Authority configuration is almost all the same in DVR and Control Center. But quick recording, backup, audio, yes or no of using channel are only possible in Control Center.

### 7.4 Browser available

WebViewer is optimized to Windows Internet Explorer 6.0 or higher in PC for smooth use.

#### Webviewer Installer

Login page provides manual installation program to use WebViewer function.

PC that access to WebViewer first installs ActiveX to use WebViewer's function. At this time when installation is not smooth, installation program needs to download from Login Page and install manually.

**Caution**

**When install WebViewer Installer, it must close all program related to Control Center. It might not be efficient to install.**

**7.5 Monitor**



When it is authorized with User ID & Password input at Login page, it moves to Monitor page. At Monitor page, monitor real time image of cameras connected to DVR, or it can control PTZ camera, Relay, and use Microphone function according to user's authorization.

Study introduction of each Monitor part and functions of the page.

**7.5.1 Screen division and changing video position**

When access to first Monitor page, it is displayed into 9 division, 16divisions or 32 divisions according to number of channel.



It can to change to 1, 4, 9, 13, 16, 25, 36 divisions by click number on top of page.

Also, it can change to 1 channel mode by click any one of channel image.



Double click on one of the playback screen to convert in 1 channel mode.



After conversion to 1channel mode, double click on screen to return to previous division channels.

At division screen, it can change screen location.

If 3channel image moves to 6ch, drag 3ch image and drop on 6ch location so as to exchange between 3ch and 6ch image

### 7.5.2 Move to Playback



Move to playback with clicking the above image.



### 7.5.3 Channel On/Off

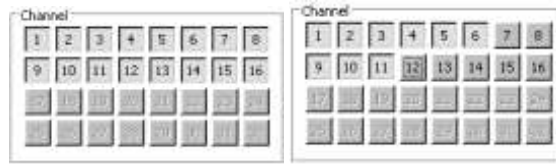

It is On/Off button for the Channel located to left in page. Click the channel wanted to On or Off. And Default is On.

### 7.5.4 Sensor Indication

The icon indicates when sensor occurs in system



When it sensed, relevant sensor icon comes to Red, and indicates sensor number of video.

### 7.5.5 Relay operation

It can On or Off Relay of the unit. Click the number button to activate Relay On, then the icon changes from Blue to Orange color.



Disabled Relay button refers to do not support and relate to this unit.



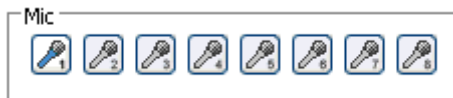

Relay is need user's authority. Refer to user manual in the unit for the setup of User's authority of Relay.

### 7.5.6 Using microphone



It can On or Off the use microphone. Default is Off and it is changed from the Blue to Red when click the button for the use Mic.





### 7.5.7 Event data

2009.03.31 10:42:13		7 On	CH7 - Motion Detected
2009.03.31 10:42:13		6 On	CH6 - Motion Detected
2009.03.31 10:42:13		5 On	CH5 - Motion Detected
2009.03.31 10:42:13		1 On	CH1 - Motion Detected
2009.03.31 10:42:13		16 On	CH16 - Motion Detected

It shows real time event data occurred at the bottom of monitoring page.

Indicated Event data list are as follow..

(Table. Event Icon)

Button	Function
	Motion Detect On
	Sensor Input
	Relay Output On
	No Video, Video Detected

### 1.2.1. Video Recording & Save saving

#### 7.5.7.1 Video Recording

During monitoring, it can record max. 10 minutes of video by click Quick Recording button "". During Quick Recording, recording time is indicated on video.



During video recording, if click Quick Recording button "" to stop recording and open the dialogue box to store recorded files. At this time, user can save it to the directory with any file name by user.

Saved recording file is saved into "\*.re4" file format. re4 file can playback through Control Center Playback program or Mini Player program.

#### 7.5.7.2 Saving Video

There are 3 types for saving Video - jpg, bmp, eye, saving means the function to record 1 frame

of current monitoring channel.

To save video, select the channel and click right button of mouse. Ans select “Save As” and point out the location and press Save button.

### 7.5.8 Using PTZ

Among the icon on top of video on monitoring, click ‘PTZ’ to activate interfacing to control Pan, Tilt, Zoom, and Focus. But, when PTZ camera is connected and ready to set PTZ, the button is activated to use the functions.



#### Pan, Tilt Control

Mouse is on the image and click right button to pop-up menu for the selection or “PTZ” or  button. Then it show Cross line on the middle of screen and click image to operate Pan, Tilt. At the middle click Left/Right direction to control Pan, and Click Up/Down direction to control Tilt. Click as far from the middle to activate Pan/Tilt faster.

#### Zoom, Focus Control

Move mouse to the edge of left & right to see slide bar for Zoom, Focus.

The unit Area Zoom In available has Zoom Zero operating button. It can Zoom In/Out using slide bar at left of image, left slide bar can control Focus.

#### Move to Preset

In case of Preset set, Mouse on image press right button for pop-up menu and “Goto Preset” is indicated additionally. When select Preset list, it moves to Preset position selected. Preset should be set up by user in advance.

#### Activating Auxiliary

In case of Preset set, “Auxiliary” is indicated additionally, and it operates action when select registered menu.

Reference

Supported PTZ camera list can be referred to '4.8 PTZ manipulation.

### 7.5.9 Using Audio



In case of Channel setup sync with Audio, press right mouse button on the image to activate pop-up menu to "Listen" or activate Audio listen button. First default is Mute. In case of listening Audio, select pop-up menu or button. After cancelling mute, control audio volume. It can mix several channels of audio

### 7.5.10 Closing Video Channel

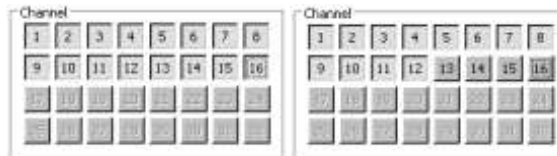

Cancel for disconnection of image monitoring by click 'Close' at top right on screen, then it comes to black screen.

To reconnect the channel disconnected, it can reconnect relevant channel using 'Channel On/Off' menu.

## 7.6 Playback



This page is to playback recorded images, and user who has authority of 'HDD' among user ID or administrator can use this function.

Playback that is made up 16 divisions can play the images by searching through calander by recording period and moving the period. It can backup recorded image and also print Pause image or save to Bmp file.

### 1.2.2. Video Division & Changing Channel

1 | 4 | 9 | 16

Playback supports 1, 4, 9, and 16 divisional screens. It can select division using menu on tip of page as above picture. 32ch DVR can call the channel using Group moving button as follow.

◀ Prev ▶ Next

If screen shows 4 divisions CH1~CH4 and look for next CH5~CH8, it can change the channel with click 'Next' button. Press 'Prev' button to call for previous channel group CH1~CH4.

### 7.6.1 Image recording

Save Print Backup

It can save playback image to BMP file.

Click mouse to channel to save. Dotted line will be surrounding to the selected channel, and click 'Save' button.



Save Image dialog box appears, then it can input message or select channel name, date, event data.

Press 'OK' to open dialog box for the saving location, then save bmp file.

### 7.6.2 Printing

Select image with mouse for the channel to print image saved, and then click 'Print' button.

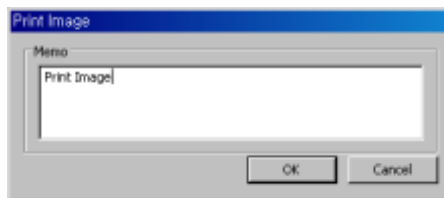

Window comes to input Memo, and click 'OK' button to print the image through the printer connected.

Print material includes 'Printing Date', 'Channel name', 'Recording Date' 'Event', 'Memo'.

### 7.6.3 Backup

There are re4(Mult channel) and avi(single channel) Set From, To time and select the channel for backup

Point out the location for backup. Input in Password/Verify.

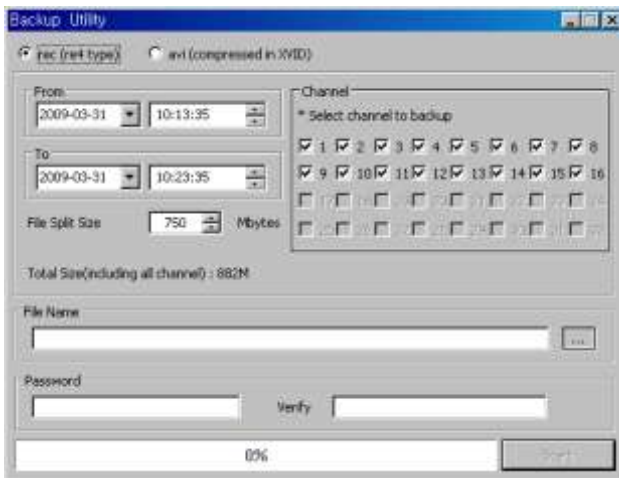

### 7.6.4 Web Monitor



Click 'Go' button at top of page, and it can move Web monitor page.

### 7.6.5 Channel On/Off

It is the same function like Channel On/Off function at Web Monitor.

It is Channel On/Off button located on right of Page, and click On or Off page for wanted channel. Default is On.

Disabled Channel button refers to do not support and relate to this unit.

### 7.6.6 Saving time & Checking Rec. Capacity

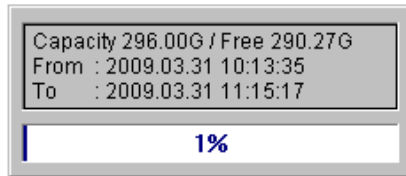

It indicates total capacity of HDD & remains and shows Starting date & Last date of recording. Also it shows percentage (%) for HDD capacity.

### 7.6.7 Searching Calander

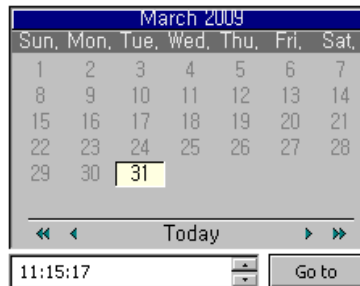

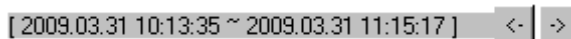

Recorded date is abled in black color, and others unrecorded date disabled in grey. Select button after select date & time so as to playback images on the date & time selected.

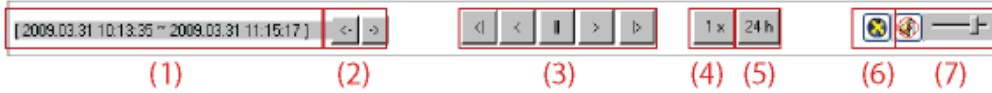

When click 'Go To' button, it indicates for 24hours from the time selected at left bottom. As above picture, it is possible to change the time zone with '24h' button

### 7.6.8. Functional function at the bottom of monitor



- ① Indicates playback range of recorded image.
- ② Press  button as the time set at (5) so as to change the time zone to playback in forwarding and backwarding.
- ③ From left button, it can 'Move a frame back', 'Play backward', 'Stop', 'Play', 'Move a frame forward'.
- ④ It is the function to set play speed. After click the button, it can set the play speed '0.5x, 1x, 2x, 4x, 16x, 32x, 64x, and All'.
- ⑤ It is the function to set play area. After click the button, it can select play area '10min, 30min, 1hour, 3hour, 6hour, 12hour, 24hour'.
- ⑥ It can select DirectX use or not. If check DirectX mode, it can play image into Direct Draw based on graphic card and performance of PC.
- ⑦ It is the function to set audio play or not, and volume.



## 8. User manual for Mobile Viewer

Mobile viewer is viewer service to monitor video via mobile device.

To access mobile viewer, user uses mobile device supporting Wi-Fi or smart phone or 3G.

### 8.1 Log-In page

Below picture is Mobile viewer log-in page.

To access log-in page via mobile viewer, please, type the address like <http://IP/mvmenu.html>.

Below image is accessed login page to <http://211.53.133.187/mvmenu.html> .

To do log-in, please, enter ID/PW and select Resolution and channel number and cycle and push [0] Start View button.



### 8.2 Monitoring page

This is the page on Log In.

It shows selected channel video and functions right below the screen.

For functions, please, refer to the below.



- [0] MENU : Move to Log In page
- [1] CH- : Move to the previous channel.
- [2] UP : Move to upside of Pan Tilt movement
- [3] WIDE : Zoom Out action
- [4] ← : Move to left side of Pan Tile movement
- [6] → : Move to right side of Pan Tile movement
- [7] CH+ : Move to the next channel
- [8] DN : Move to downside of Pan Tilt movement
- [9] TELE : Zoom In action

# Trouble shooting

## 1. DVR booting failure

1. Check the power
2. Check Power cord

## 2. No video on monitor

3. Check monitor power
4. Check cable between DVR and monitor
5. Check monitor cable port
6. Check DVR power is off
7. If monitor video is gray mode, check the camera type(NTSC/PAL) and reboot.

## 3. No video in some of channel

8. Check Camera power
9. Check Camera video input
10. Check DVR input port
11. Check On/Off of Activity configuration of Screen
12. Check Covert configuration of Monitor

## 4. No recording

13. Check Disk Manager if HDD is mounted or not
14. Check recording configuration

## 5. No playback

15. Check recording configuration
16. Check button

## 6. If video is too much bright or dark

17. Check Camera configuration
18. Check and dismantling power cable near video cable.
19. Check Brightness, Contrast of screen

## 7. Remote controller is not working

20. Check Remote controller battery
21. Check Remote controller ID
22. Check Remote Controller manipulation

## 8. If front button is not working

23. Check DVR Power
24. Check Screen Lock

## 9. If network is not working

25. Check if Network cable is connected
26. Check DVR IP
27. Check Computer IP
28. Ping Test
29. Check PC specification if Webview video is not shown.

## **10. The cases necessary to contact the shop**

30. In case of extraordinary working(ex: noise, smell or fume)
31. Connetor breakage of power cable
32. In case that rain or water is in the product
33. In case that liquid or foreign is in the product
34. If the product is not working in accordance with the manual.
35. In case of breakage from product dropping
36. In case that product performance drop dramatically

## #1. The way to check the manufacturing date

It can be checked with its S/N(Serial Number).

## #2. S/N : Serial Number

It means composite 12 digit number with product model name and production year,month, and week. It can be found on the attached label attached on the bottom of product or system info of configuration tool or system information 1 of DVR Func menu.

### Serial Number Structure

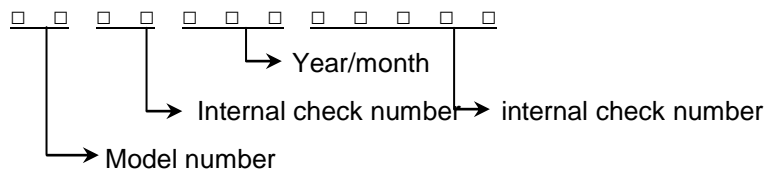

- (1) 1~2 digits : Identify Model name of product
- (2) 3~8, 8~12 digits : Hunt internal number
- (3) 5~6 digits : Manufacturing year
- (4) 7 digits: Manufacturing month

Please see the below table for manufacturing month.

Jan	Feb	Mar	Apr	May	Jun	Jul	Aug	Sep	Oct	Nov	Dec
1	2	3	4	5	6	7	8	9	A	B	C

## The example of verifying manufacturing date using serial number

The below S/N can be verified as following as:

『 EB0009200707 』

- (1) “EB” means “MD1600E”.
- (2) “092” means it is produced in “2009 Feb”
- (3) “00707” means the serial number.

## Available HDD

Plase ask to seller about HDD available with DVR.

## Compatitable CD/DVD list

DVD-R manufacturer	CD-R Manufacturer
Mitsubishi(x16 recomended)	Mitsubishi(x52 recomended)
TDK(x16 recomended)	TDK(x52 recomended)
Imation(x16 recomended)	Imation(x52 recomended)
Sony(x16 recomended)	Sony(x48 recomended)

## Specification

### HVRM-T1600M, HVRM-T800M, HVRM-T400M

Video input	
Video input standard	NTSC or PAL auto detect
Connectors	HVRM-T1600M : 16ch, HVRM-T800M: 8ch, HVRM-T400M : 4ch analog video inputs BNC connector
Loop out	Auto terminated loop out
Main Video output	
Main output	output via BNC & DVI HVRM-T1600M : 1,4,9,10,16 mode, HVRM-T800M : 1.4.9 mode, HVRM-T400M : 1.4 mode User defined sequence / alarm pop-up 1920x1080, 1280x720, 1280x1024, 1024,768 at DVI port
Spot output	output via BNC, 1 divison mode only User defined sequence / alarm pop-up
Recording	
Compression	H.264 / JPEG
Resolution	CIF/Half(2CIF)/D1(4CIF)
Rate	HVRM-T1600M : 480 at CIF, HVRM-T800M : 240 at 2CIF, HVRM-T400M : 120 at D1
Quality	5 levels
Mode	Manual & Event / Schedule & Event
Scheulde	24hrs / 7day
Playback	

Mode	Instant playback / Search
Speed	120 fps,
Search Type	Time, Calender, Event, Thumbnail
Block Playback	1day ~ 31days
<b>Event &amp; Alarm</b>	
Event source	MD, Sensor, Text
Event check schedule	24hrs / 7day
Event Action	Recording, Relay, E-mail, Buzzer, Pop-up, Warning Message, PTZ preset
MD Area	22x15(NTSC), 22x18(PAL)
Sensor input	dry contact (N.O. or N.C. selectable)
Text input	POS/ATM support, AVE VSI Pro/Hydra support
<b>System Alarm</b>	
Alarm source	HDD fail, HDD almost full, Fan fail, Pwd fail, DDNS fail
Alarm action	Warning message, buzzer, e-mail, relay
<b>Audio</b>	
Input/output	4 RCA input, 1R CA output
Compression	16KHz, 16bit sampling ADPCM
Direction	Both
<b>PTZ</b>	
Protocols	32 models including Bosch, Pelco, Sony, Merit-lilin, Honeywell
<b>Network</b>	
Interface	1 10/100 Ethernet
Type	Fixed IP, Floating IP, ADSL
DDNS	supported
Bandwidth Limit	supported
NTP	Server/Client/Both
Users	10 monitoring, 2 playback
Streaming	1 H.264 same as recording 1 additional H.264 smaller than recording 1 JPEG for e-mail sending or mobile
<b>Security</b>	
User Level	1 admin, 10 users
User privilege	Menu, PTZ, Relay, PB, Power on/off, Backup

IP Filtering	supported
<b>Storage/Backup</b>	
Storage Devices	2 internal SATA HDDs, 1 external eSATA I/F
File System	Proprietary file system, data-loss protection against power-failure
Capacity	Max 8TB
Backup type	multi-channel or single channel avi file
Backup device	internal CD/DVD or USB drive(T1600Q/T800Q Series : Option)
S.M.A.R.T.	Temperature and Health
<b>Serial &amp; I/O</b>	
Serial port	1 RS-232C, 2 RS-485
Sensor input	HVRM-T1600M : 16 dry-contact, HVRM-T800M : 8 dry-contact, HVRM-T400M : 4 dry-contact
Relay output	2 relay
<b>Controller</b>	
Device	Front panel, IR remote, Joystick KBD, Mouse
<b>Software</b>	
WebViewer	Monitoring / Playback
Mobile Viewer	Monitoring with PTZ, iPhone & BB supported
CMS	Control Center Standard, max 1000 clients
SDK	ActiveX(COM) SDK
<b>Environmental &amp; Physical</b>	
Dimension	W : 359.0, L : 413.3, H : 88.0
Operating temperature	Operating: 41 ~ 113 degrees F.
Power	AC free volt (100 ~ 240VAC)
Power consumption	Max. 75W Typical 50W



**HVRM-T1600Q, EH800L**

<b>Video input</b>	
Video input standard	NTSC or PAL auto detect
Connectors	HVRM-T1600Q : 16ch, HVRM-T800Q : 8ch analog video inputs BNC connector
<b>Main Video output</b>	
Main output	output via BNC & VGA HVRM-T1600Q : 1,4,9,10,16 mode HVRM-T800Q : 1.4.9 mode User defined sequence / alarm pop-up 1280x1024, 1024,768 at VGA port
Spot output	output via BNC, 1 division mode only User defined sequence / alarm pop-up
<b>Recording</b>	
Compression	H.264 / JPEG
Resolution	CIF/Half(2CIF)/D1(4CIF)
Rate	HVRM-T1600Q : 240 at CIF, HVRM-T800Q : 240 at CIF
Quality	5 levels
Mode	Manual & Event / Schedule & Event
Schedule	24hrs / 7day
<b>Playback</b>	
Mode	Instant playback / Search
Speed	240 fps without network playback 30fps with network playback
Search Type	Time, Calendar, Event, Thumbnail
Block Playback	1day ~ 31days
<b>Event &amp; Alarm</b>	
Event source	MD, Sensor, Text
Event check schedule	24hrs / 7day
Event Action	Recording, Relay, E-mail, Buzzer, Pop-up, Warning Message, PTZ preset
MD Area	22x15(NTSC), 22x18(PAL)
Sensor input	dry contact (N.O. or N.C. selectable)
Text input	POS/ATM support, AVE VSI Pro/Hydra support
<b>System Alarm</b>	

Alarm source	HDD fail, HDD almost full, Fan fail, Pwd fail, DDNS fail
Alarm action	Warning message, buzzer, e-mail, relay
<b>Audio</b>	
Input/output	4 RCA input, 1R CA output
Compression	16KHz, 16bit sampling ADPCM
Direction	Both
<b>PTZ</b>	
Protocols	32 models including Bosch, Pelco, Sony, Merit-lilin, Honeywell
<b>Network</b>	
Interface	1 10/100 Ethernet
Type	Fixed IP, Floating IP, ADSL
DDNS	supported
Bandwidth Limit	supported
NTP	Server/Client/Both
Users	10 monitoring, 2 playback
Streaming	1 H.264 same as recording 1 additional H.264 smaller than recording 1 JPEG for e-mail sending or mobile
<b>Security</b>	
User Level	1 admin, 10 users
User privilege	Menu, PTZ, Relay, PB, Power on/off, Backup
IP Filtering	supported
<b>Storage/Backup</b>	
Storage Devices	2 internal SATA HDDs
File System	Proprietary file system, data-loss protection against power-failure
Capacity	Max 8TB
Backup type	multi-channel or single channel avi file
Backup device	internal CD/DVD or USB drive(T1600Q/T800Q Series : Option)
S.M.A.R.T.	Temperature and Health
<b>Serial &amp; I/O</b>	
Serial port	1 RS-232C, 2 RS-485
Sensor input	HVRM-T1600Q : 16 dry-contact, HVRM-T800Q :

	8 dry-contact
Relay output	2 relay
<b>Controller</b>	
Device	Front panel, IR remote, Joystick KBD, Mouse
<b>Software</b>	
WebViewer	Monitoring / Playback
Mobile Viewer	Monitoring with PTZ, iPhone & BB supported
CMS	Control Center Standard, max 1000 clients
SDK	ActiveX(COM) SDK
<b>Environmental &amp; Physical</b>	
Dimension	W : 359.0, L : 413.3, H : 88.0
Operating temperature	Operating: 41 ~ 113 degrees F.
Power	AC free volt (100 ~ 240VAC)
Power consumption	Max. 75W Typical 50W

# Product size

## T1600M/T800M/T400M Series

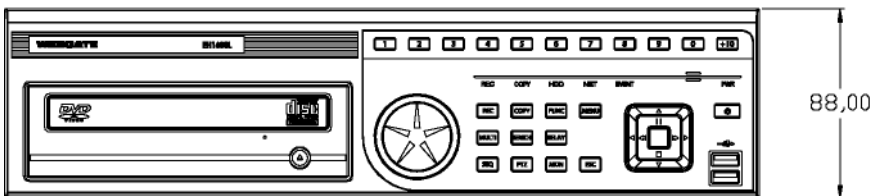
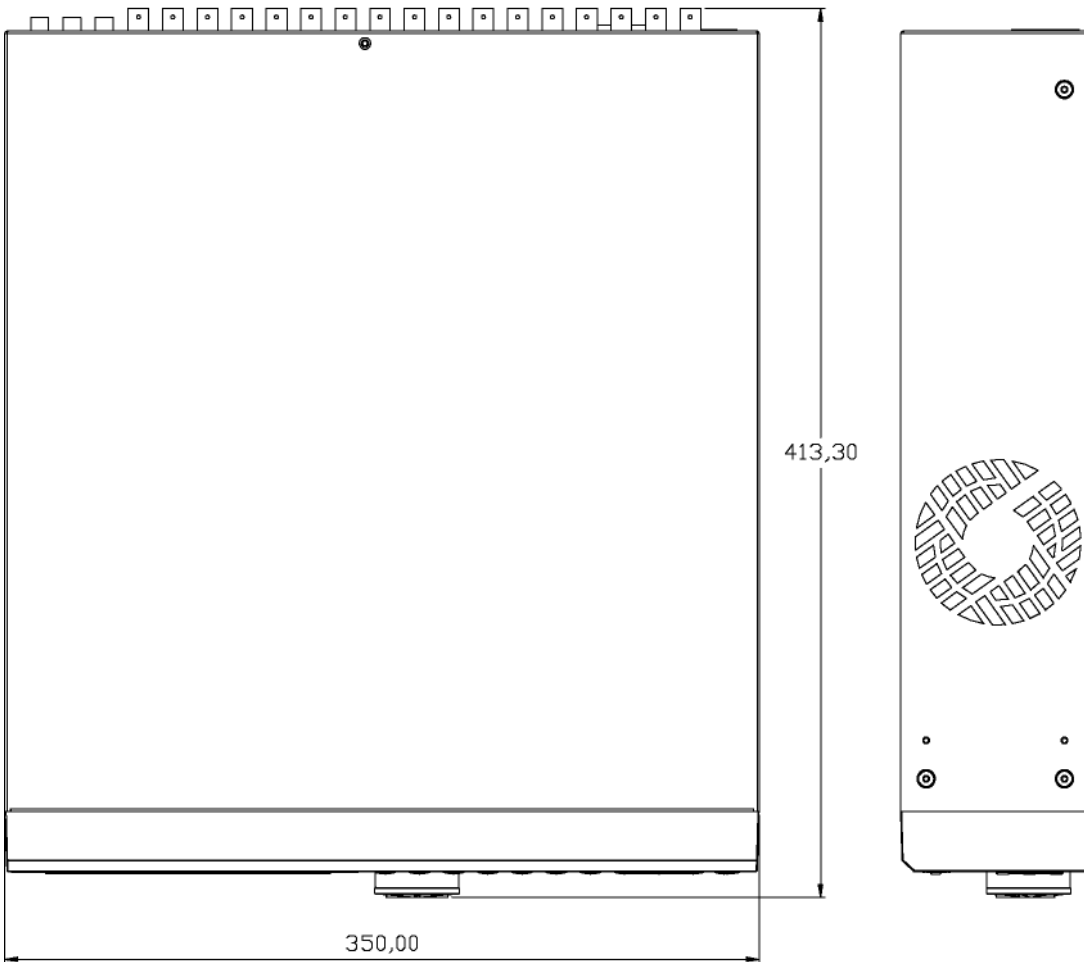
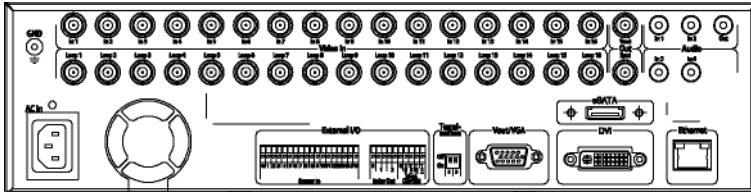

T1600Q/T800Q Series

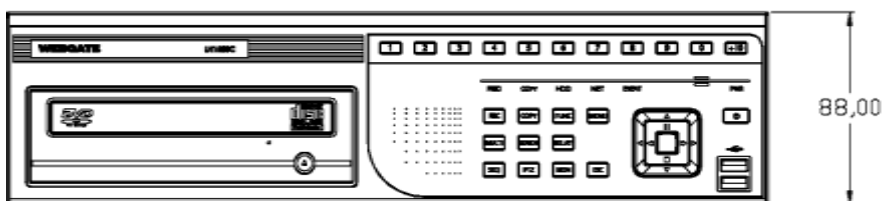
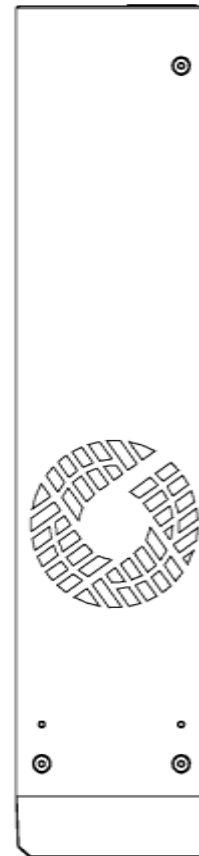
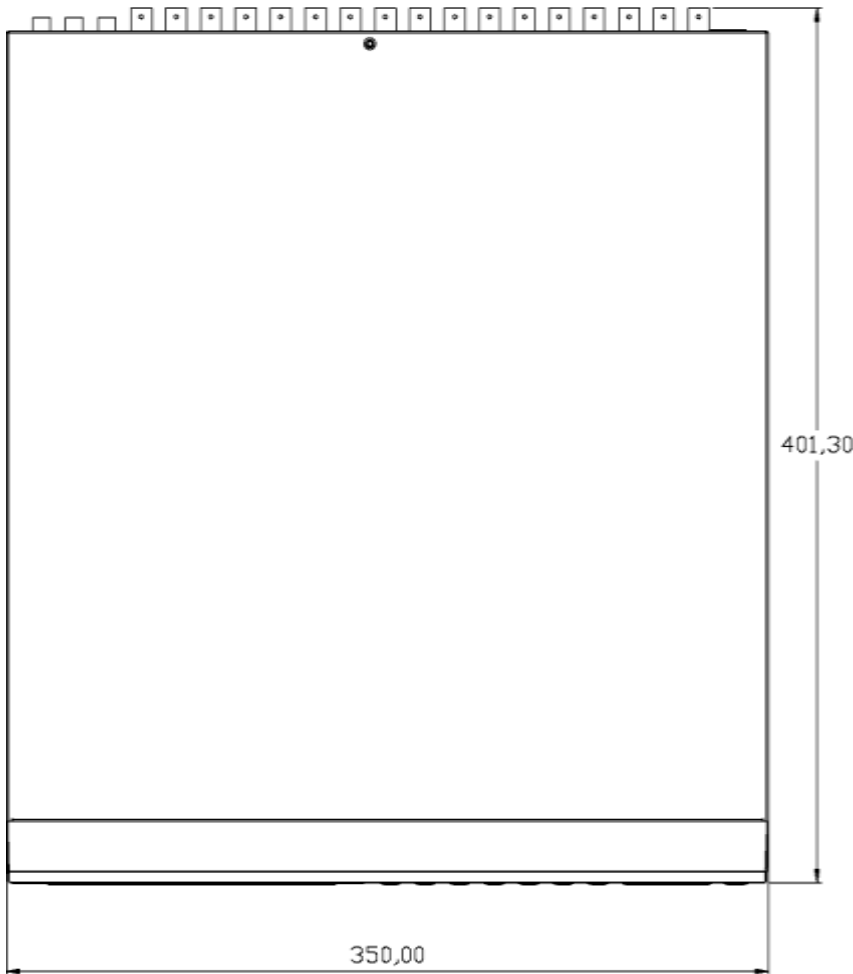
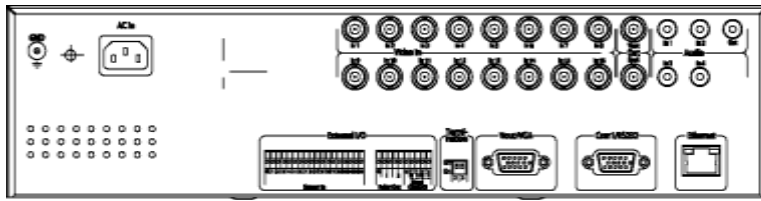

**HUNT ELECTRONIC USA INC.**

11790 Jersey Blvd.

Rancho Cucamonga, CA 91730

Tel: (888)993-4868, (909)987-6999

Fax: (909)987-6997

[techsupport@huntcctv.com](mailto:techsupport@huntcctv.com)

[www.huntcctv.com](http://www.huntcctv.com)