



# GRANDIO

G R E E N H O U S E S

Model **GRA-ELI812**



8x12 GRANDIO ELITE

## **GREENHOUSE USER MANUAL**

© 2013 Grandio Greenhouses, Backyard Living Source Inc. All rights reserved  
August 1, 2014 Manual Edition



Dear Valued Customer,

We would like to congratulate you on your new Grandio Greenhouse purchase. We are confident that you have made the right decision in choosing Grandio. Our greenhouses are made with high quality aluminium and polycarbonate and will last for many garden seasons to come.

Please take the time to carefully read this instruction manual for an easier and more enjoyable assembly experience.

Cheers!

Grandio Greenhouses

Save this owner's manual for future reference and if you need our help.

**CONTACT OUR CUSTOMER SERVICE  
DEPARTMENT at:  
1-866-928-3150**

Hours: 8:30a.m.-5:00p.m. Monday through  
Friday (Mountain Standard Time)

**Backyard Living Source  
9543 W. Emerald St., Suite 101  
Boise, ID 83704**

**[www.grandiogreenhouses.com](http://www.grandiogreenhouses.com)**

## **IMPORTANT! PLEASE READ BEFORE BEGINNING ASSEMBLY**

### **Before you begin take time to complete this check list.**

- Take inventory of all parts using the parts list at the back of this manual.
- Be cautious where you place the polycarbonate panels as they will burn grass or plants if left on top of them in direct sunlight. Note that clear film side of panels should always face the sun and opal film side faces inside greenhouse.
- Plan out when and where you are going to place the greenhouse, we recommend that you place it in an area that will receive direct sunlight and will be protected from the wind as much as possible
- It will take at least (2) people to put the greenhouse together.
- Before your build, make sure you are allowed to build it! Consult all building codes, as well as City or Municipality ordinances and HOA's, as you may need a permit or documentation before you build.
- Contact your insurance company to make sure your Grandio Greenhouse will be covered on your policy.
- Call your local utilities companies before digging.
- Do not attempt to begin construction on a windy day.
- Your greenhouse should be built on a flat level surface allowing for drainage.
- Read this entire manual to get familiar with all pieces and parts prior to beginning assembly. Follow the steps outlined in the order presented!



## **IMPORTANT! SAFETY INSTRUCTIONS**



### **FAILURE TO FOLLOW THESE WARNINGS MAY RESULT IN SERIOUS INJURY OR PROPERTY DAMAGE AND WILL VOID WARRANTY.**

To ensure safety, do not attempt to assemble this product without following the instructions carefully. Check entire box and inside all packing material for parts and/or additional instruction materials. **Before beginning assembly, read the instructions and identify all parts using the hardware identifier and parts list on pages 35-40. Complete assembly and proper usage are essential to reduce the risk of accident or injury when using your Grandio Greenhouse.**

**CAUTION: Do not leave polycarbonate panels laying on grass or leave in the sun or extreme heat, keep in a cool dry place until they are to be installed!!** (May cause burning to plants or grass if left directly on top of them, also may damage panels due to the protective film adhering to panels.)

- Remove approximately 2 inches of film from all polycarbonate sheet edges before installing. Remove all protective film immediately after the construction is completed. Clear film side of panels should always face the sun and opal film side faces inside.
- Due to shipping, the grooves of some of the aluminum profiles may be too small to insert into the polycarbonate sheet, you may carefully use a screwdriver to pry the framework open so the polycarbonate sheet can be inserted smoothly.
- Do not use or store hot objects such as grills, blow torches, welding equipment, etc. in or near your greenhouse.
- Do not allow children or pets to play in greenhouse or in the set up area until assembly is complete.
- If using a ladder during assembly, use extreme caution.
- A clean level surface is essential to maintaining the solid integrity of the structure, Install the base correctly as described in manual. Please anchor the greenhouse down to a firm and level base.

### **TOOLS YOU WILL NEED FOR ASSEMBLY**

- |                            |   |                         |
|----------------------------|---|-------------------------|
| • <b>Tape Measure</b>      | • <b>Step Ladder</b>                          | • <b>Masking Tape</b>   |
| • <b>Level</b>             | • <b>Work Gloves</b>                          | • <b>Safety Glasses</b> |
| • <b>Carpenter Square</b>  | • <b>Flathead Screwdriver</b>                 | • <b>10mm Wrench</b>    |
| • <b>At Least 2 Adults</b> | • <b>No. 1, 2 and 3 Phillips Screwdrivers</b> |                         |



When you see this icon pay special attention to the helpful tips we have provided that will make installation more efficient.

# PREPARE A FOUNDATION FOR YOUR GRANDIO GREENHOUSE

Before assembling your new greenhouse a proper foundation must be prepared. A number of anchoring options are acceptable, based on wind and ground conditions in your area.

It is extremely important to have the area prepared and leveled for installation of your greenhouse prior to starting the assembly of your Grandio Greenhouse.

Decide at this time the final orientation of your Greenhouse. We recommend that you place your greenhouse in a location where it will receive the most direct sunlight and will be best protected from wind and storm conditions.

Go to [www.grandiogreenhouses.com](http://www.grandiogreenhouses.com) for foundation ideas and tour our online learning center for tips and tricks for putting your greenhouse together.

## ⚠ IMPORTANT: POLYCARBONATE PANELS ⚠

Remove approximately 2 inches of film on both sides of each panel prior to installation. Remove all film immediately after assembly is complete. The UV-Protected side is covered with transparent film and must face toward the sun. The side covered in opal film will always face the interior of the greenhouse.

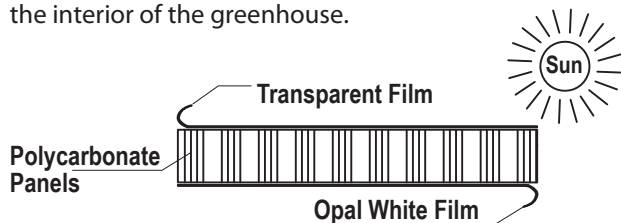

## 8X12 GRANDIO ELITE BARN STYLE GREENHOUSE DIMENSIONS

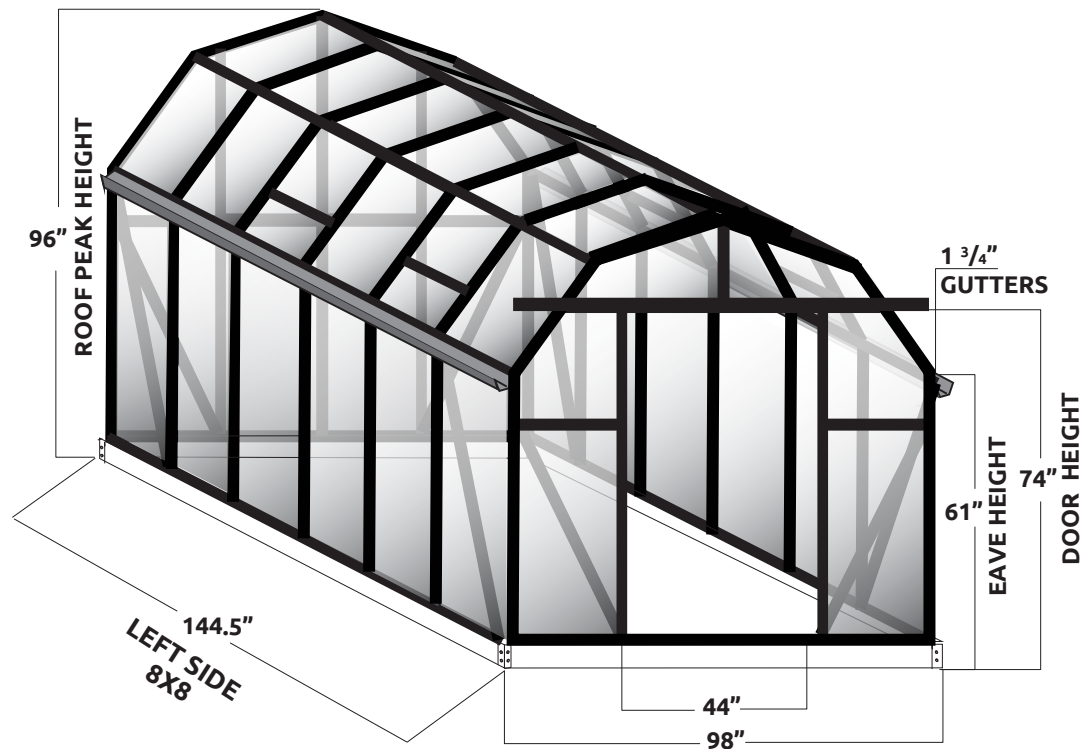

# BACK

This diagram shows the 8x8 Grandio, for the 8x12 Grandio you will repeat the middle section of the sides as shown below on LEFT SIDE and RIGHT SIDE.

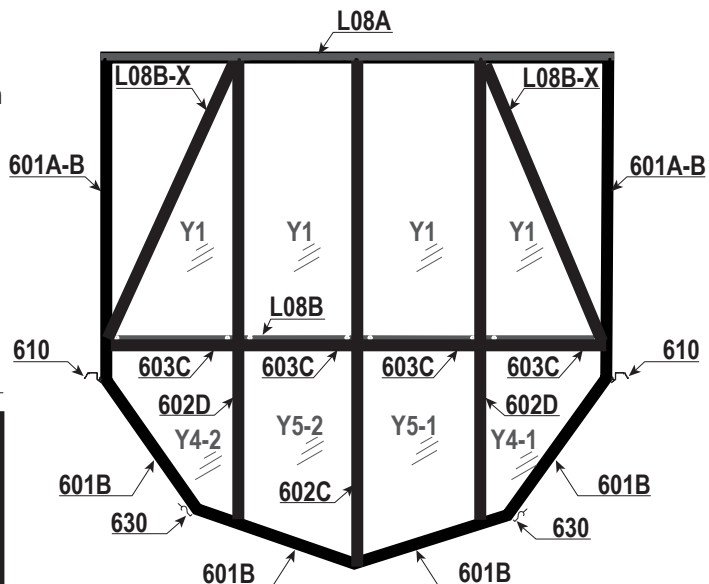

## Outside View

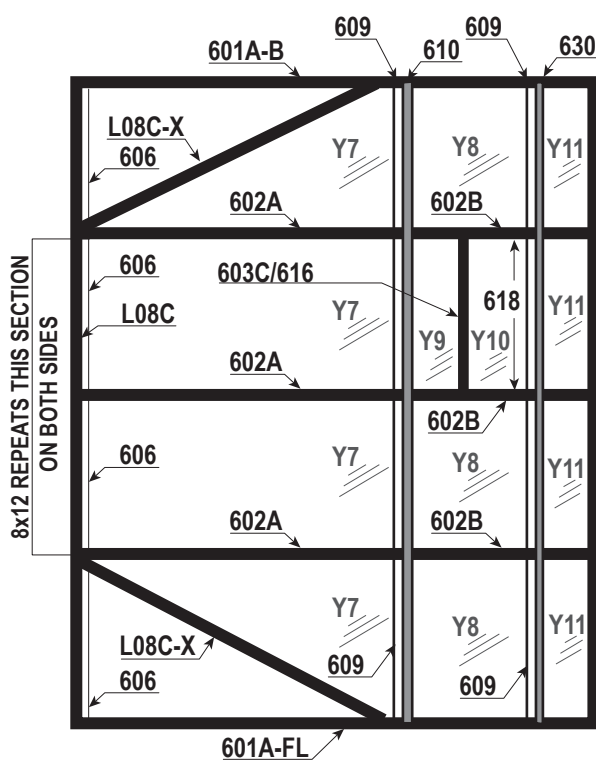

## LEFT SIDE

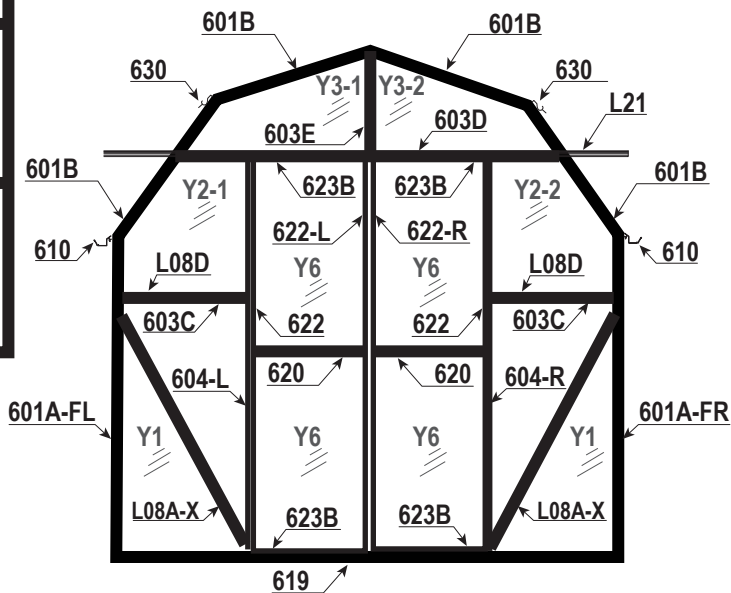

## FRONT

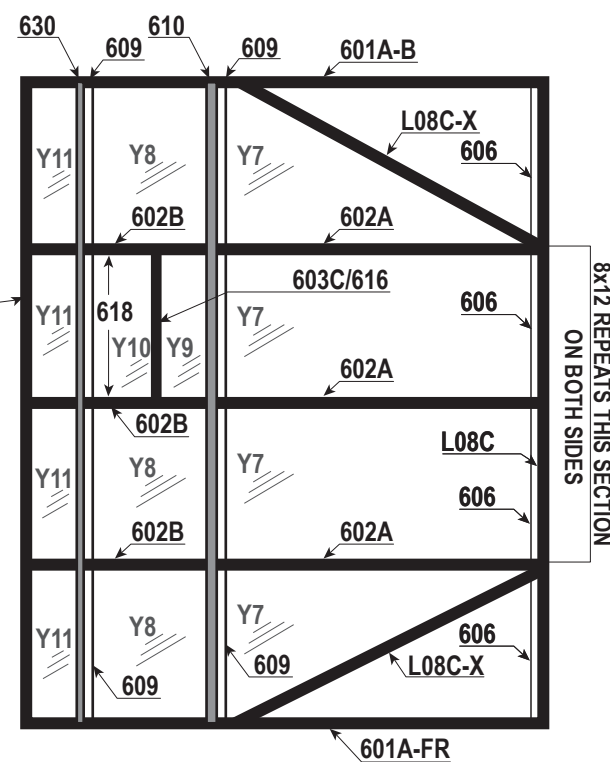

## RIGHT SIDE



**GRANDIO**<sup>®</sup>  
GREENHOUSES

## ASSEMBLY INSTRUCTION STEPS

**STEP ONE: BASE ASSEMBLY**

**STEP TWO: FRONT ASSEMBLY**

**STEP THREE: BACK ASSEMBLY**

**STEP FOUR: MIDDLE ASSEMBLY**

**STEP FIVE: DOOR ASSEMBLY**

Introduction .....	1
Safety Instruction .....	2
Plan Your Foundation .....	3
Diagram Of Assembled Grandio .	4
Base Assembly .....	6
Front Assembly .....	7
Back Assembly .....	13
Attaching Roof to Back .....	15
Middle Assembly .....	19
Attaching the Ridge .....	22
Middle Assembly Eaves .....	23
Attaching Roof Vents .....	30
Install Polycarbonate Panel .....	27
Install Gutter .....	28
Install Roof and Gutter Caps .....	29
Door Assembly .....	30
Door Installation .....	34
Install Interior Roof Supports .....	36
Parts List .....	37

# BASE KIT ASSEMBLY INSTRUCTIONS

**\*\*BASE MUST BE LEVEL & SQUARE, FOUNDATION MUST BE PROPERLY ANCHORED PRIOR TO GREENHOUSE ASSEMBLY**

## A W06 must be buried in ground.

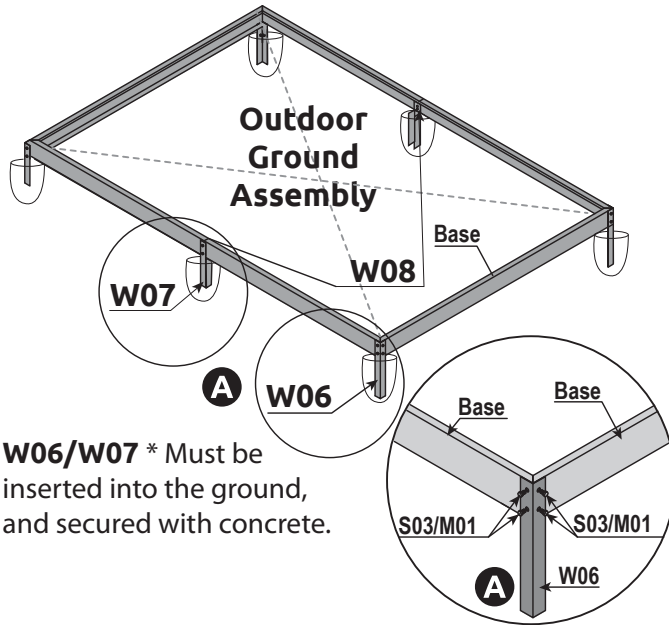

W06/W07 \* Must be inserted into the ground, and secured with concrete.



**Use:** Quikrete fast setting concrete to anchor base. Pour in Quikrete and water no mixing required. (Not Included).

**GRANDIO TIP** Make sure base is squared and level before setting anchor into concrete. Use a measuring tape to ensure all corners are the same. Use level on all four sides.

OR

## B W06/W07 must be cut for patio or deck installation

Drill holes in bottom of base to allow for proper fastener to pass through prior to moving forward with assembly. You determine and acquire proper fastener prior to installation.

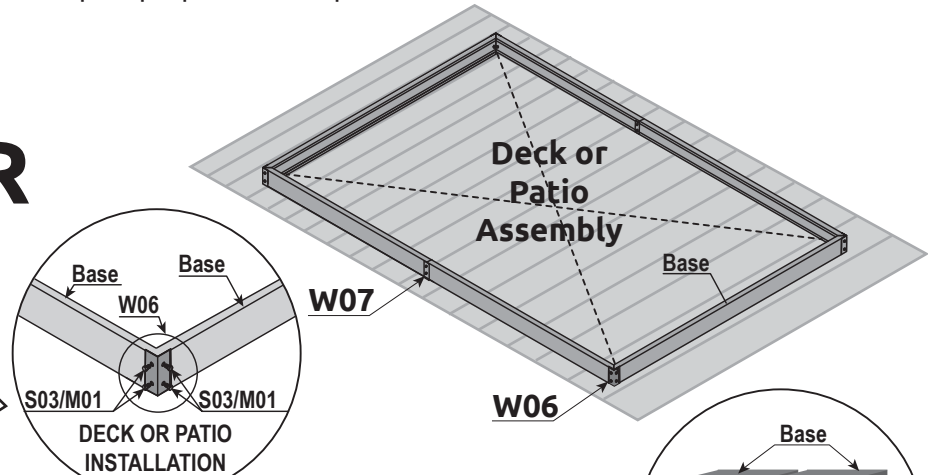

**B W06/W07 \*** Must be cut flush with frame. Use decking screws or concrete anchors to attach base. (Fasteners not included).

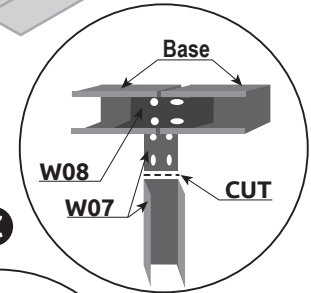

## C W06/W07 Must Be Modified

Use a Hacksaw or Tinsnip to cut down the length of **W06** and **W07**, then install cut side down to level surface.

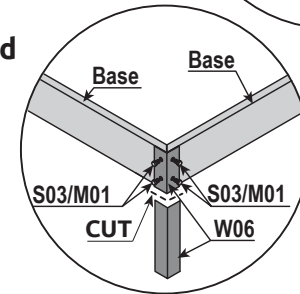

STEP ONE

# FRONT FRAME ASSEMBLY INSTRUCTIONS

This picture shows the inside view of front section fully assembled.

STEP TWO

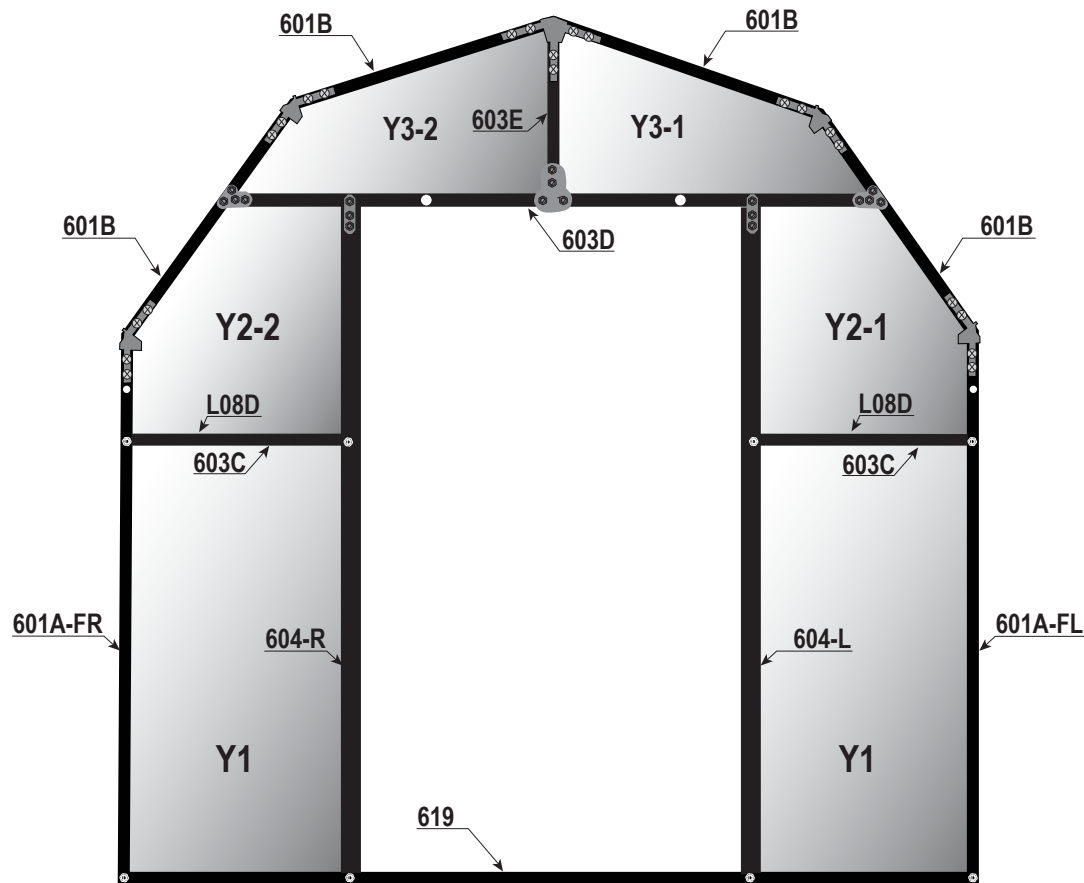

We recommend watching our how to assembly videos with tricks and tips for easier assembly and installation of your Grandio Greenhouse at: [www.grandiogreenhouses.com](http://www.grandiogreenhouses.com)



Lay flat on ground to assemble the front frame of your greenhouse. If possible try to find a shady area protected from the wind. Panels can burn grass and plants if in direct light.



**BOLT INSTALLATION TIP:** Locate all nuts and bolts, pre thread and place in the groove of the extrusion to make installation easier. Move up or down for exact placement.

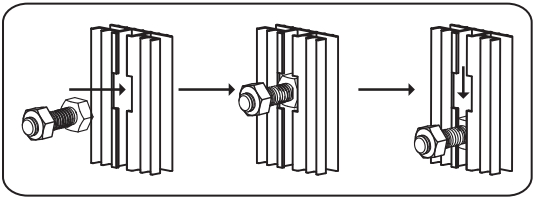



# FRONT FRAME ASSEMBLY

**2.1** Prethread all **S05** screws into the **WG01** and **WG02's** for ease of installation.

**2.2** Use **WG01** bracket to attach the (2) **601B's** together with the **603E**, secure parts with the **S05** screws provided see **A**. The **WG01** will slide into the groove of the **601B's**, and slide into the groove of the **603E**.

**2.3** Install **WG02's** into (2) **601B's** then tighten **S05** screws when extrusions are completely tight see **B**. Note: the fat end of the **WG02** will always be on the bottom side.

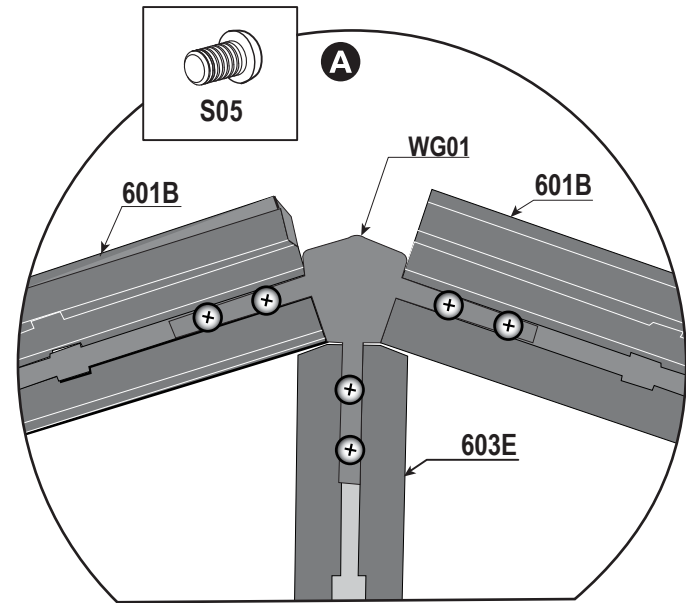

Inside View

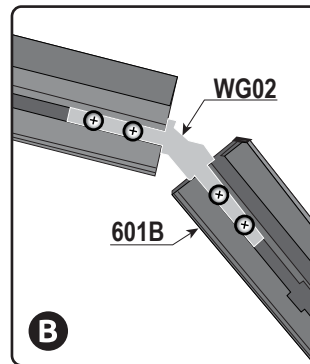

**PRETHREAD SCREWS TIP:**

Locate all **WG01**, **WG02**, and **S05** screws, pre thread these to make installation easier. Note that the fat end on the **WG02** will always face downward.

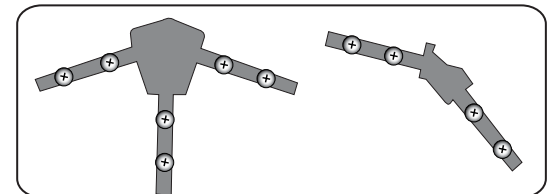
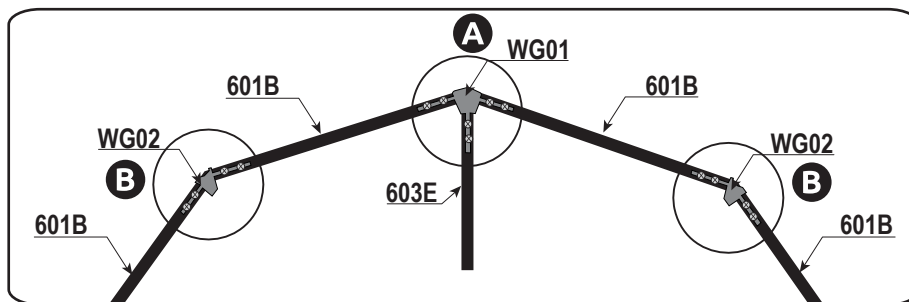

STEP TWO

# FRONT FRAME ASSEMBLY

**2.4** Insert polycarbonate panels **Y3-2** and **Y3-1** into place as shown in **(A)**.

**2.5:** Attach **603E** and **603D** with **W04** and **S04/ML01** fasteners as shown in **(B)**.

**2.6** Attach the **603D** to the **601B**'s using the **W04-1**'s with the **S04/ML01** fasteners on both sides as shown in **(C)**.

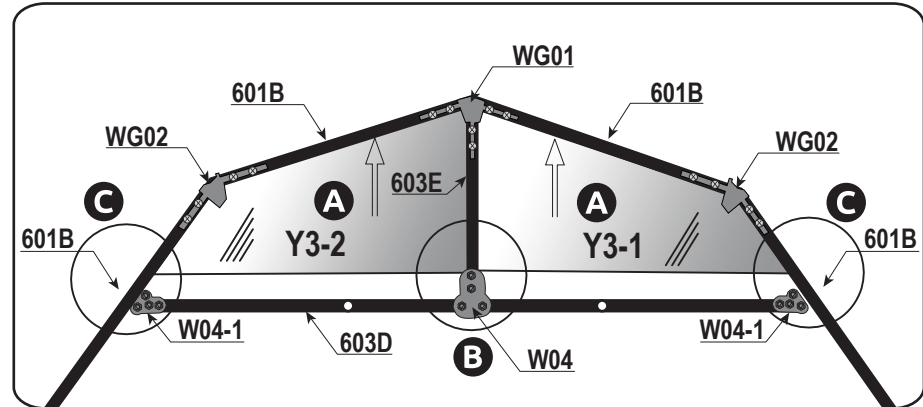

**Inside View**

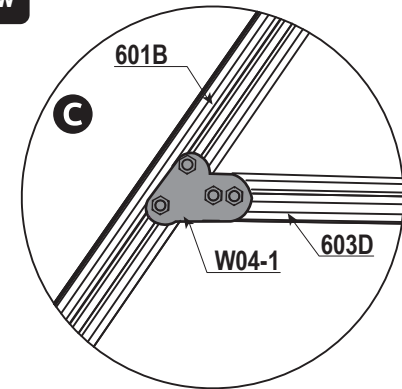
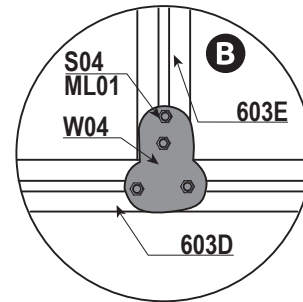

**STEP TWO**



**BOLT INSTALLATION TIP:**

Locate **ML01/S04** nuts and screws, pre thread into the **W04** and **W04-1**'s and place in the groove of the extrusion to make installation easier.

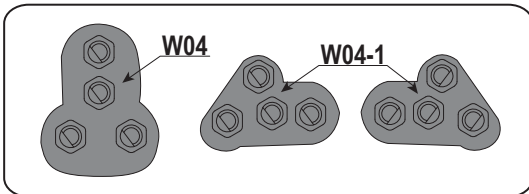

**Transparent Film**  
**Outside Greenhouse**



Polycarbonate Panel

Opal White Film  
Inside Greenhouse

# FRONT FRAME ASSEMBLY

**2.7** View diagrams and attach the (2) **604's** and (2) **601A's** to the **619**. Note the orientation of the **604's**, there are 4 different **601A's** (2) for the front and (2) for the back with different hole placements. The large holes should be at the top and facing forward on the front frame assembly. See diagram on this page.

- A** shows where the corner pieces attach to **619**.
- B** shows where the door frame attaches to the **619**.

**GRANDIO TIP** **BOLT INSTALLATION TIP:** Locate all nuts and bolts, pre thread and place in the groove of the extrusion to make installation easier. Move up or down for exact placement.

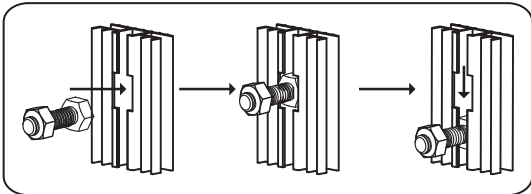

**GRANDIO TIP** Note the larger holes on **601A-FR** and **601A-FL** front pieces need to face the top front of the greenhouse.

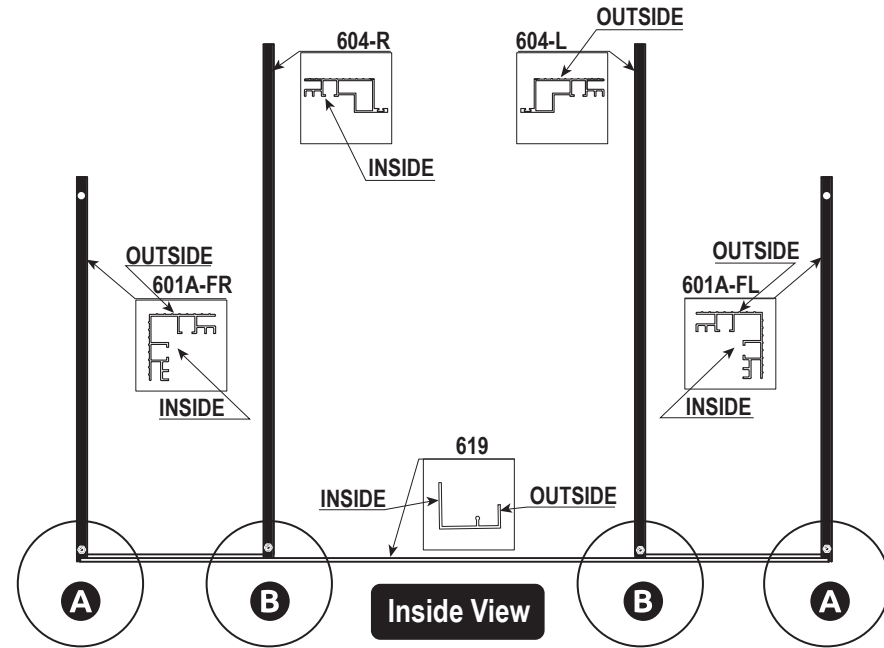

**TIP:** If necessary you may use a screwdriver to wedge behind the bolt head. This prevents bolt from falling into the track.

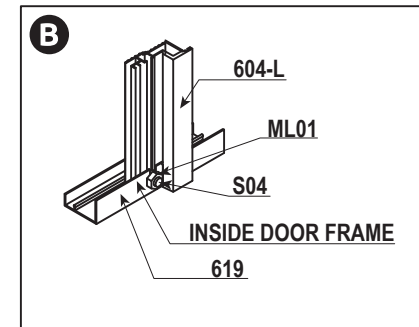
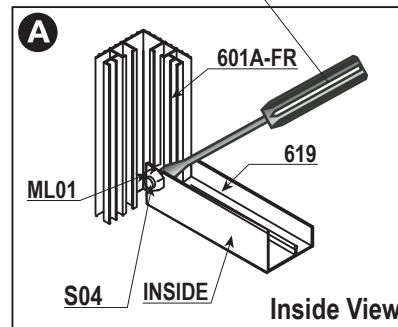

**STEP TWO**

# FRONT FRAME ASSEMBLY

**2.8** Attach **606** to **619**, this will hold the polycarbonate panels in place. If it seems too tight slide fingers or a screw driver along edges, gently stretching the **606** to allow room for panels to fit **A**.

**2.9** Insert **Y1** polycarbonate panels into place, make sure **Y1**'s slide completely into **606** as show in **B**.

**2.10** Attach (2) **603C**'s to (2) **L08D**'s, then to **601A**'s and **604**'s using **S04/ML01** fasteners, make sure it is snug with the tops of the **Y1** panels, then tighten fasteners. See **C**.

**2.11** Insert the **Y2-2** and **Y2-1** polycarbonate panels as shown in **D**.

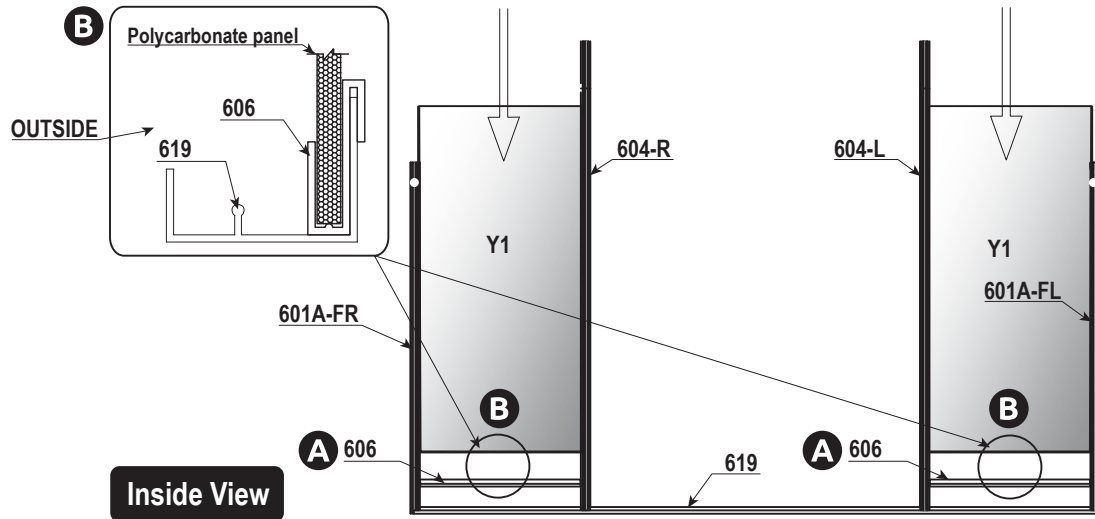

STEP TWO

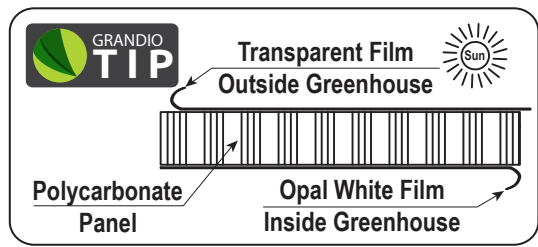
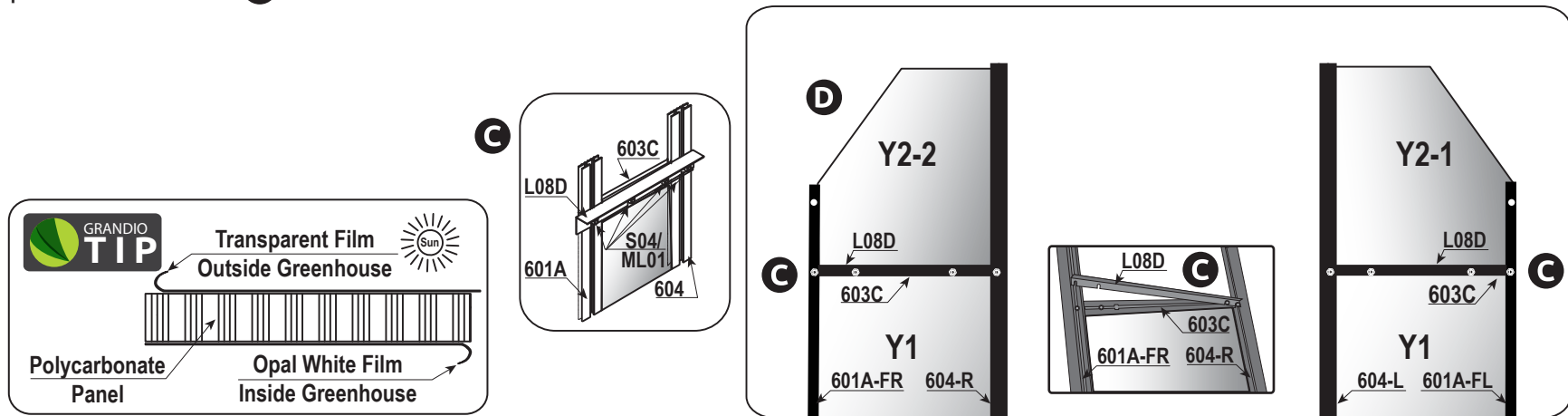

# FRONT FRAME ASSEMBLY

**2.12** Move roof and front section together and align the **WG02's** into the **601A's**, and the **W04-2's** into the **604's**. Insure a snug fit between the **WG02's**, **601B's** and **601A's** and then tighten the **S05** screw as shown in **A**. Tighten the **W04-2's** with the **S04 /ML01** nut and bolt as shown in **B**.

**2.13** Attach the **L08A-X** to **L08D** and **604** to square front section loosen **S04/ML01** attached to the bottom of the (2) **604's**, square the frame with carpenter square or use a measuring tape to make sure corner measurements are the same, also check distance across from the top of **601A's**, and also to the bottom of the **601A's** across, make sure distance is the same. Tighten **L08A-X's** to hold squareness as shown in **C**.

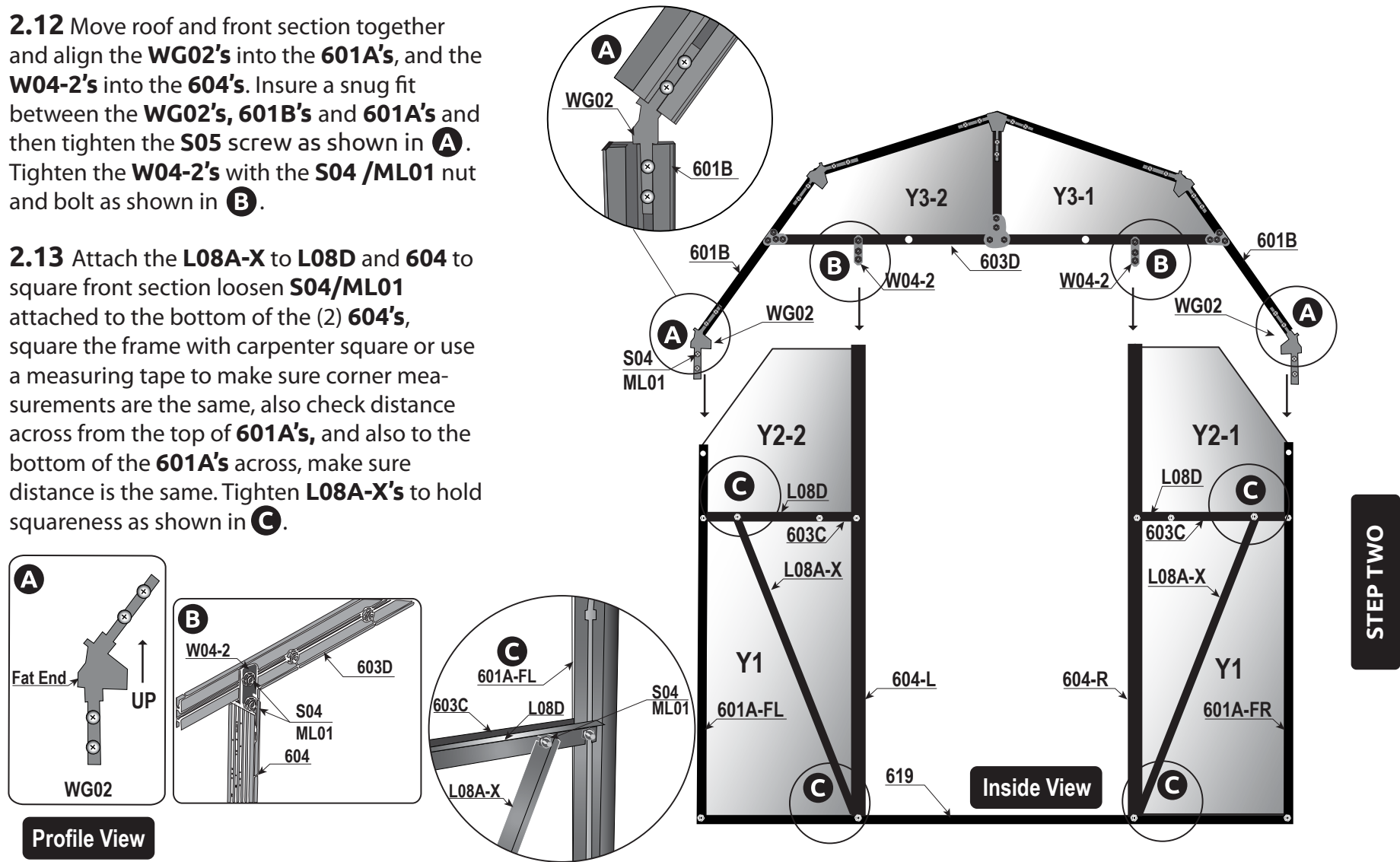

# BACK ASSEMBLY INSTRUCTIONS

This image shows the inside view of the back wall assembly.

## STEP THREE

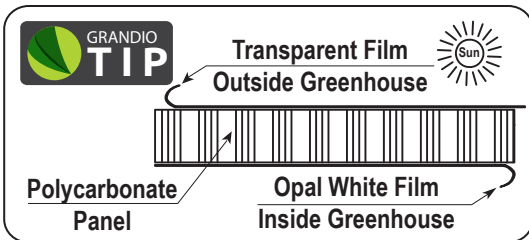

**GRANDIO TIP** Make sure the UV coated side of the panel faces outward as indicated on the panels. Avoid placing the polycarbonate panels in the sun or near plants until fully assembled.

**GRANDIO TIP BOLT INSTALLATION TIP:** Locate all nuts and bolts, pre thread and place in the groove of the extrusion to make installation easier. Move up or down for exact placement.

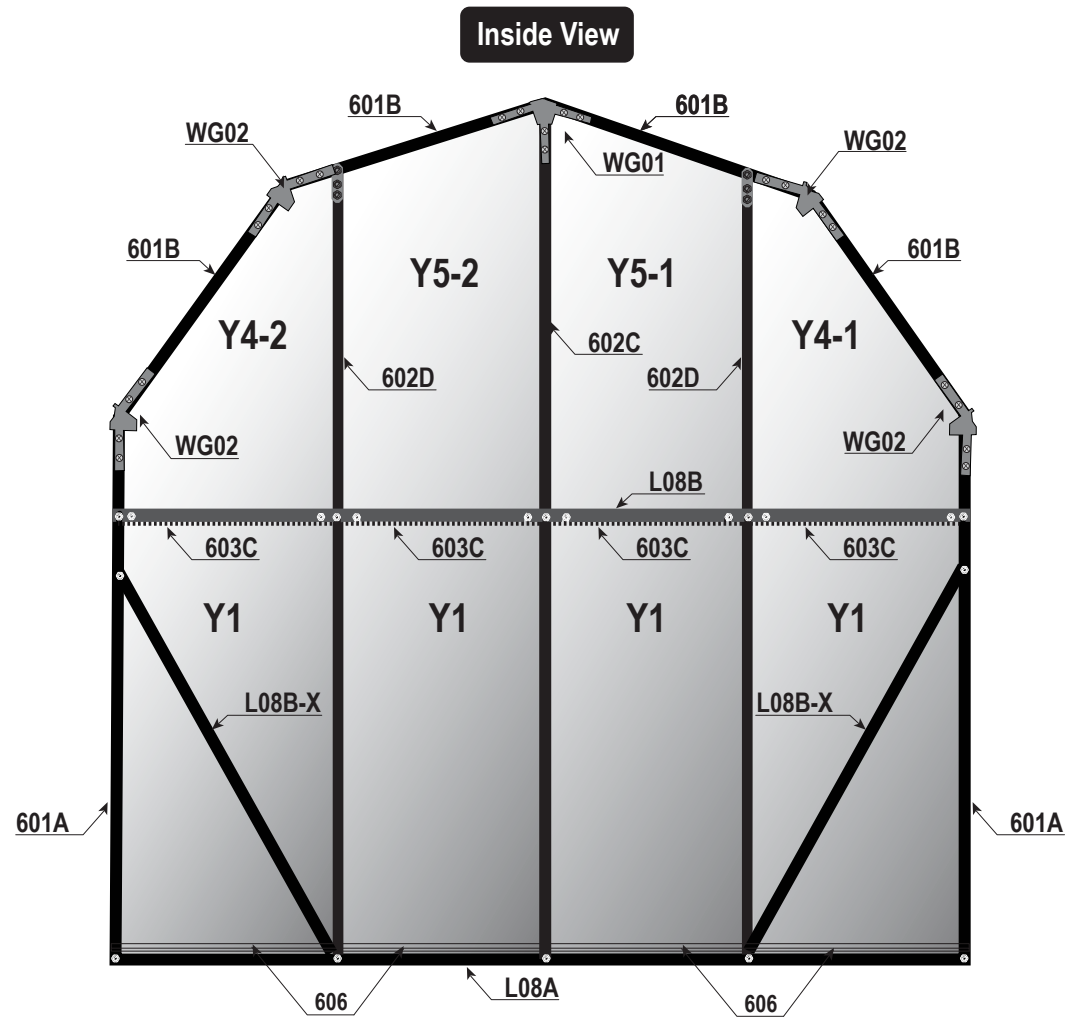
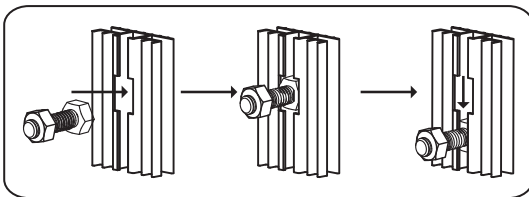

# BACK CONTINUED

**3.1** Prethread all **S05** screws into the **WG01** and **WG02**.

**3.2** Use the **WG01** bracket to attach the (2) **601B**'s together, secure parts by sliding the **WG01** into the **601B**'s as shown in diagram **A**.

**3.3** Install **WG02**'s to connect (2) **601B**'s when firmly placed between the extrusions tighten the **S05** screws, see **B**.

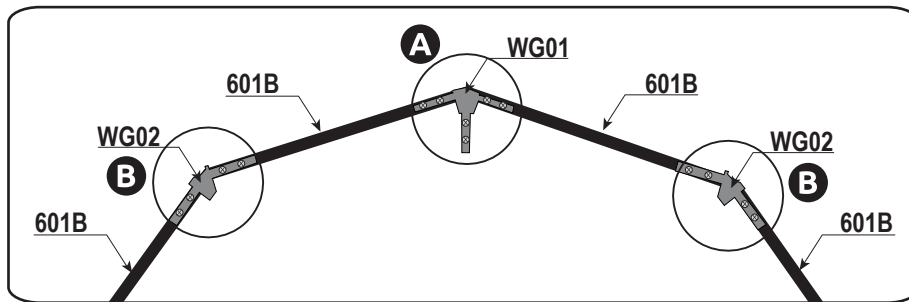
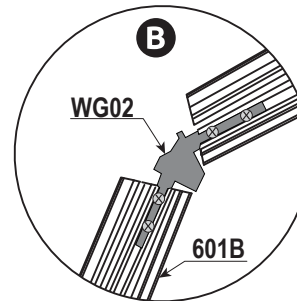
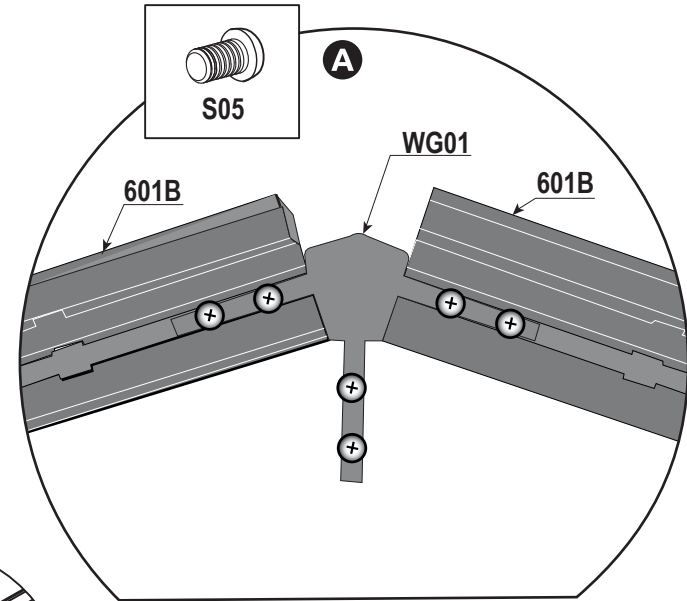

Inside View



**PRETHREAD SCREWS TIP:**

Locate all **WG01**, **WG02**, and **S05** screws, pre thread these to make installation easier. Note that the fat end on the **WG02** will always face downward.

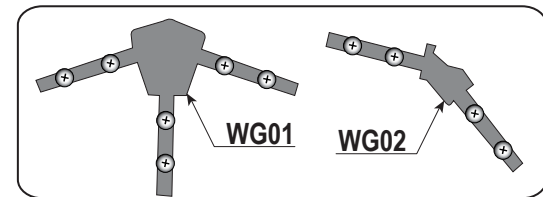

STEP THREE

# BACK CONTINUED

**3.4** Attach (2) **601A-B's** to **L08A** using **S04/ML01** fastener as shown in diagram **A**.

Attach (2) **602D's** to **L08A** using **S04/ML01** fasteners as shown in diagram **B**.

Attach **603C** to **L08A** using **S04/ML01** fastener as shown in diagram **C**.

**3.5** Attach the (4) **606's** to the **L08A** as shown in **D**.

**3.6** Insert the **Y4** polycarbonate panels into the grooves of **601A**, **602D** and **602C**. Make sure **Y4** panels are inserted into **606** as shown in **D**. You may need to use a screwdriver to gently open the **606** to fit the polycarbonate panels into the groove of **606**.

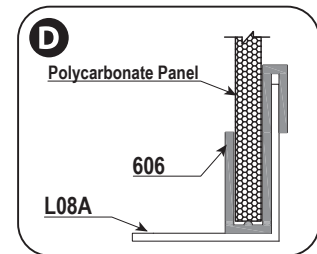
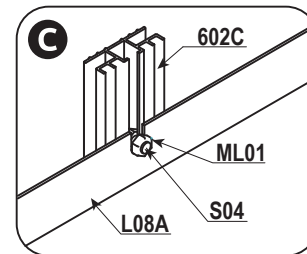
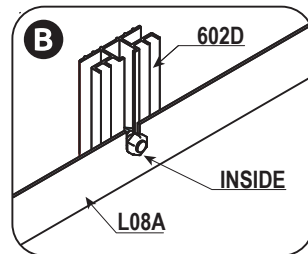
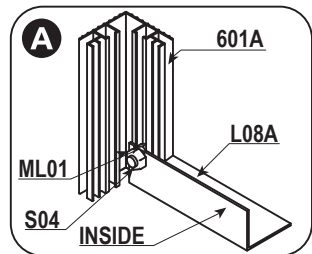
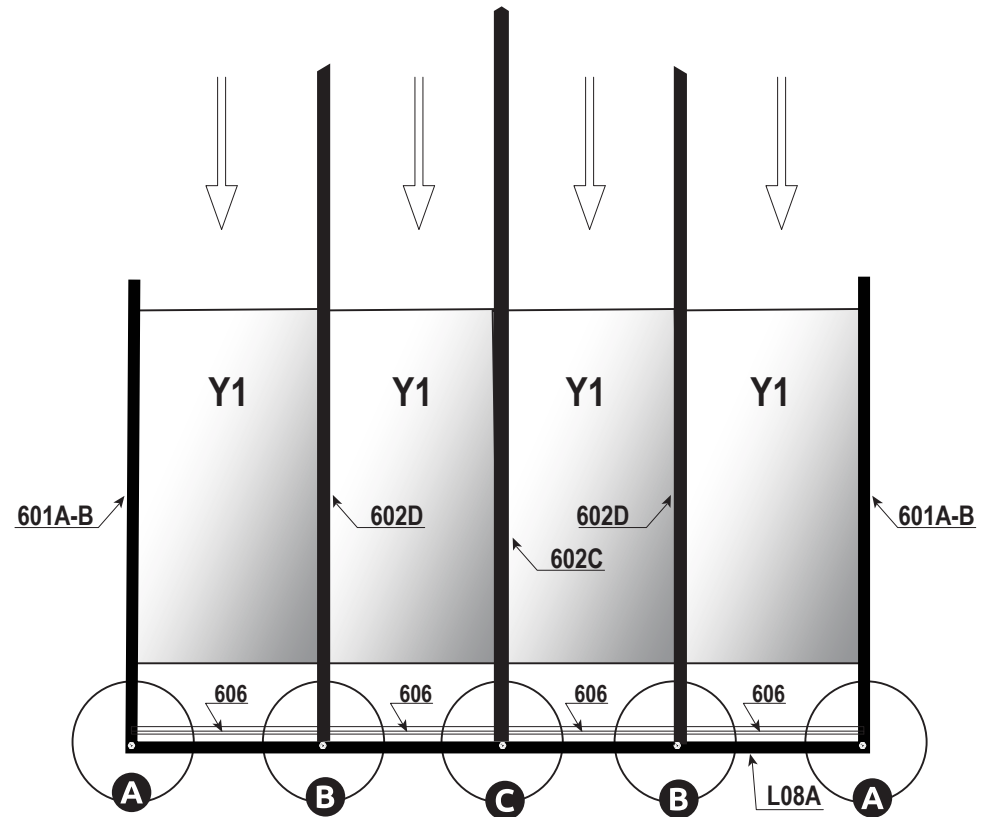



# BACK CONTINUED

**3.7** Attach (4) **603C**'s atop each **Y-1** panel, then align the pre threaded **S04-ML01** fasteners in each **603C** to the **L08B** and to each **601A-B**, **602D** and the **602C**. When aligned tighten the middle first and work your way outward. See diagrams **A**, **B**, **C**.

**3.8** Insert the **Y5-1** and **Y5-2** polycarbonate panels into place. Then insert the **Y4-1** and **Y4-2** into place as shown in the diagram.

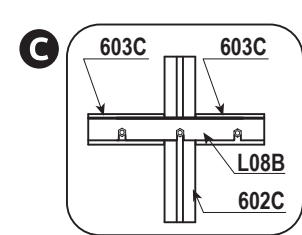
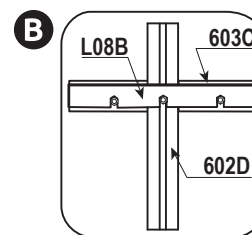
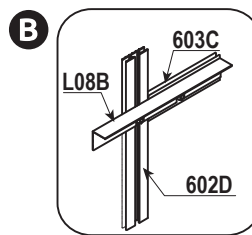
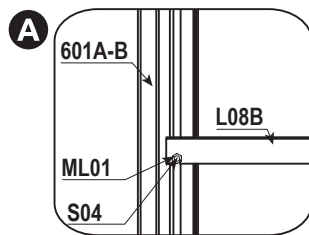
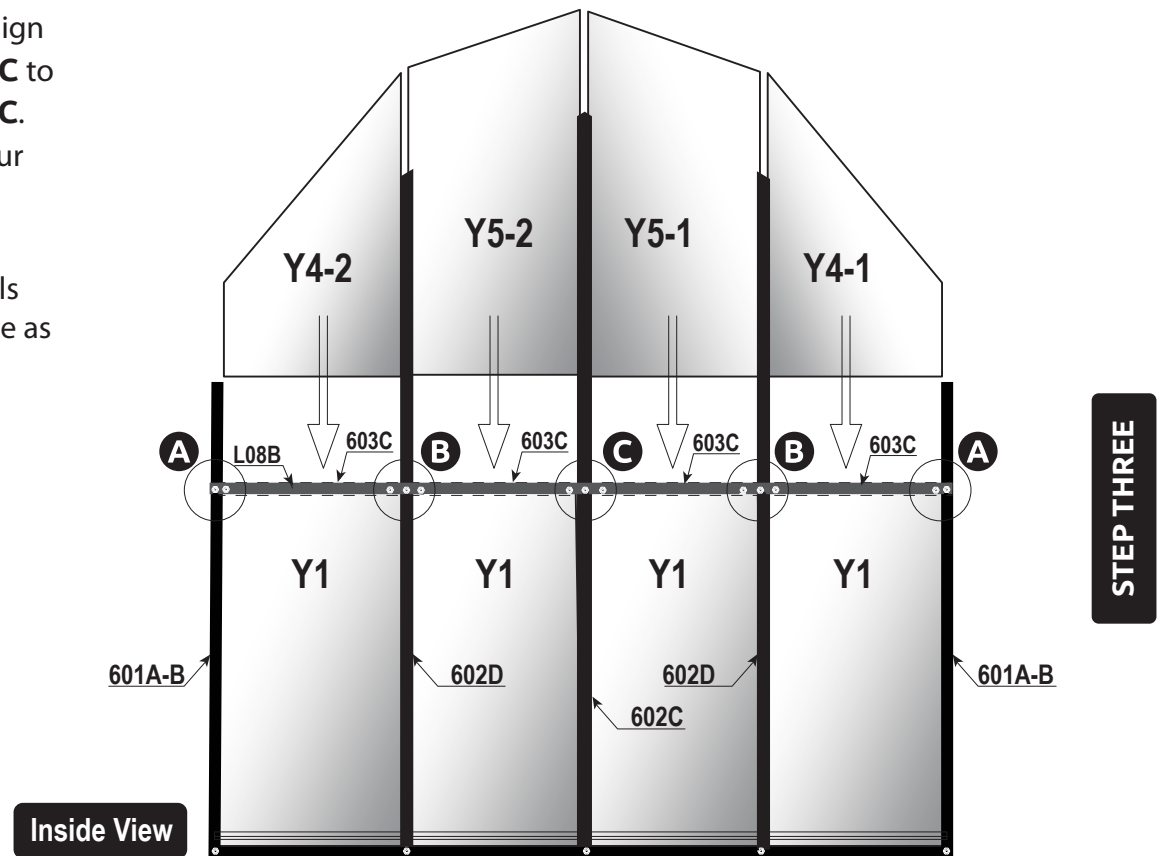

# BACK CONTINUED

**3.9** Pre thread the **S05** screws on **WG01**, **WG02's** and the **ML01/S04 W04-2's** brackets and place into appropriate extrusion see **A**, **B** and **C**. Align **WG02's** into **601A's**, the **W04-2's** into **602D's**, and the **WG01** into the **602C**. When all members are snug tighten all fasteners to lock into place.

STEP THREE

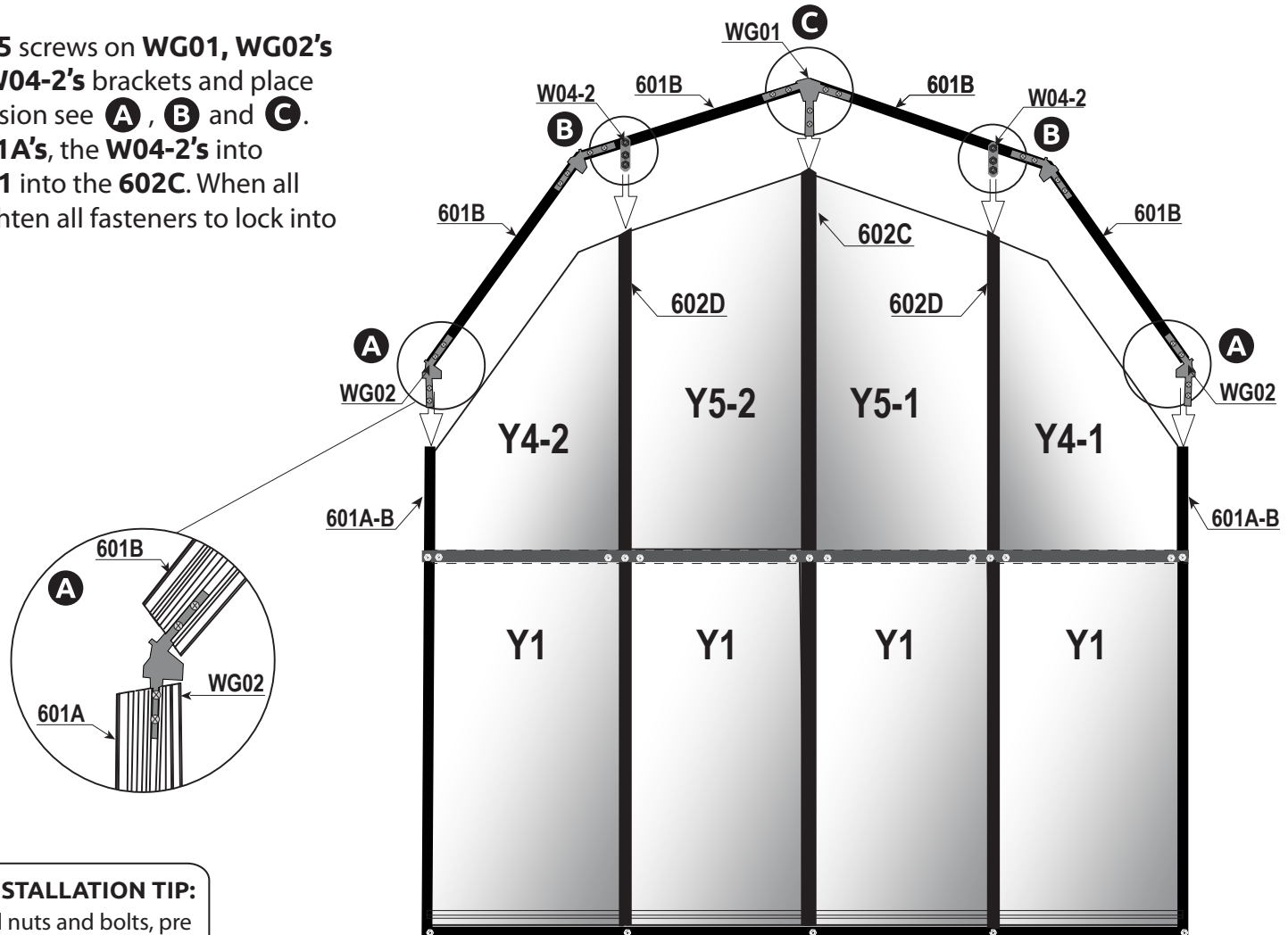

**BOLT INSTALLATION TIP:**

Locate all nuts and bolts, pre thread and place in the groove of the extrusion to make installation easier. Move up or down for exact placement.

Inside View

# BACK CONTINUED

## 3.11

**A.** Attach (2) **L08B-X's** to (2) **602D's** and **L08A** with **S04/ML01** as shown in **A**.

**B.** Attach (2) **L08B-X's** to the (2) **601A's** with fasteners as shown in **B**.

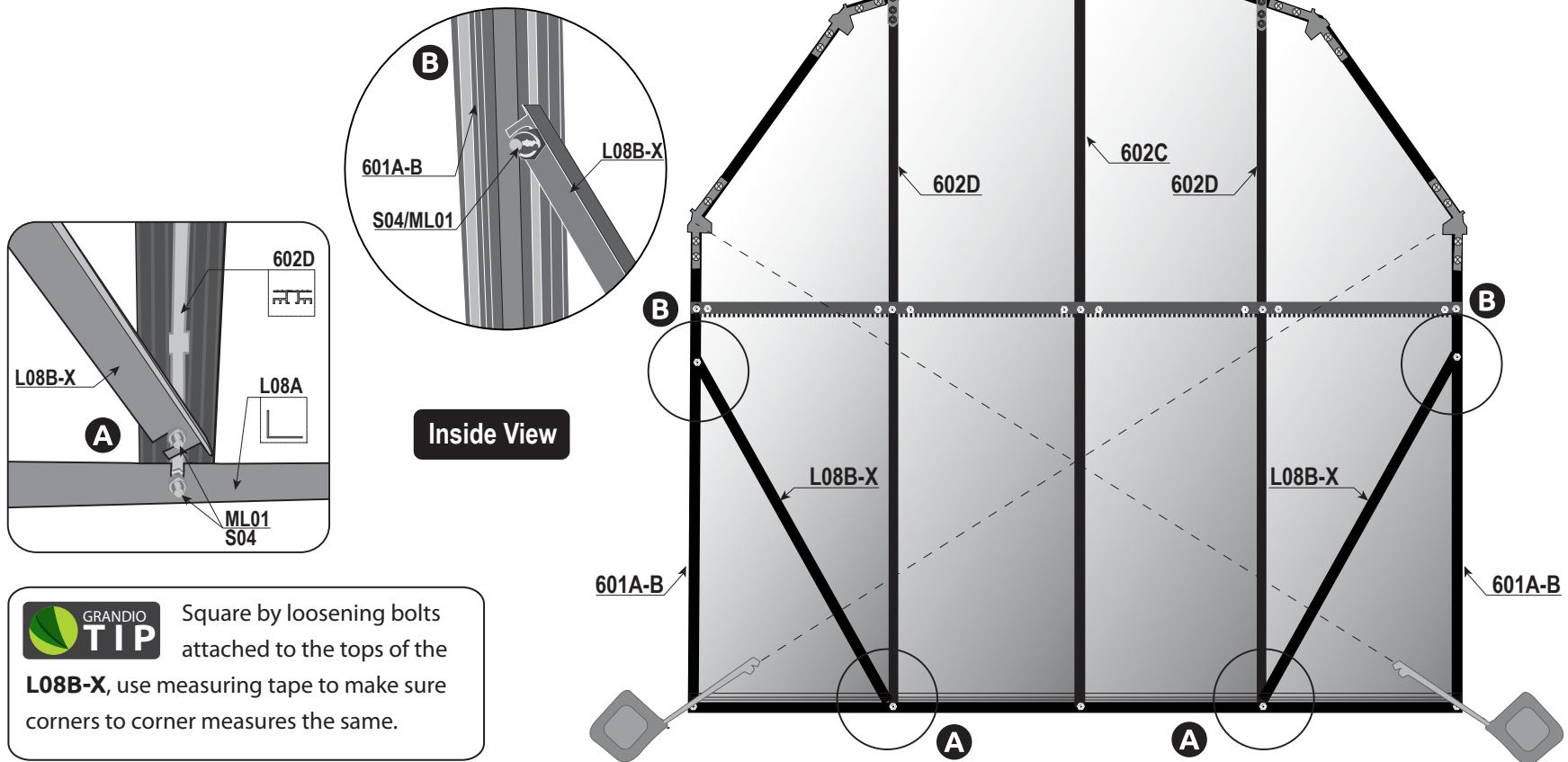

# MIDDLE ASSEMBLY INSTRUCTIONS

## STEP FOUR

**Warning:** The person(s) holding the front or back sections vertical must continue to do so until the **L08C-X** angle supports are attached securely to the front and base as shown in step 4.5. Failure to hold front vertical will cause the front to fall and damage the base kit, front framing etc. Damage caused by improper installation is not warrantable.

**4.1** With no less than 2 people place the pre assembled front section on top of the base kit front. Have one person hold the front vertically while the other attaches the front section to the base with **W05/S04/ML01** fasteners as shown in **A** and **B**.

**4.2** Attach front to base with **W05** clips as shown in **C**.

**GRANDIO TIP** You will need a minimum of (2) people to complete the middle assembly of your greenhouse. The more people the merrier at this stage of assembly.

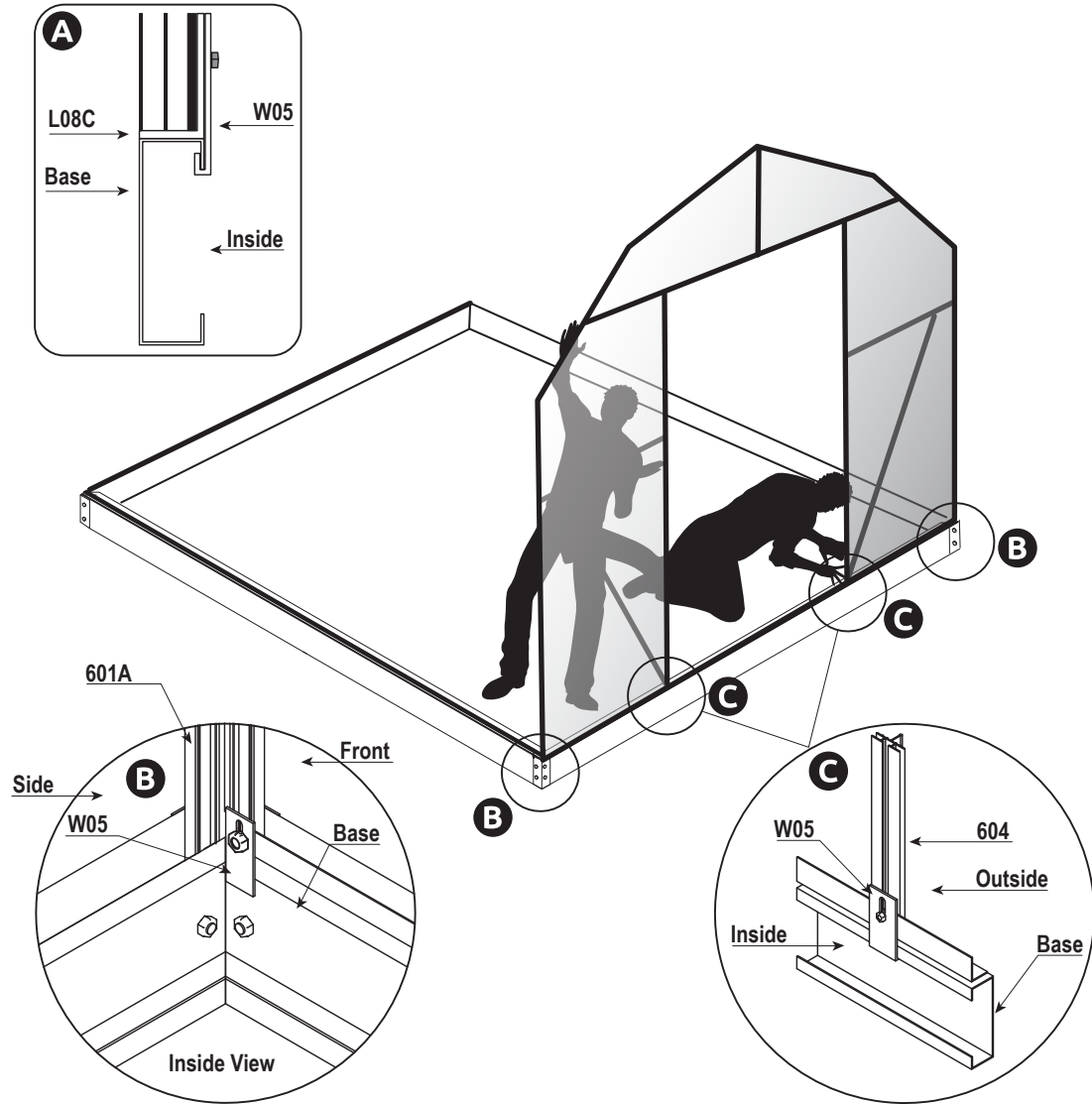

# MIDDLE ASSEMBLY CONTINUED

**4.3** While the front section is being supported vertically by the other person(s) slide in and attach the **L08C's** to the front section **601A's** using the **ML01/S04** nut and bolt as shown in **(A)**. Using tape temporarily attach the loose end of the **L08C's** to the base kit as shown in **(B)**.

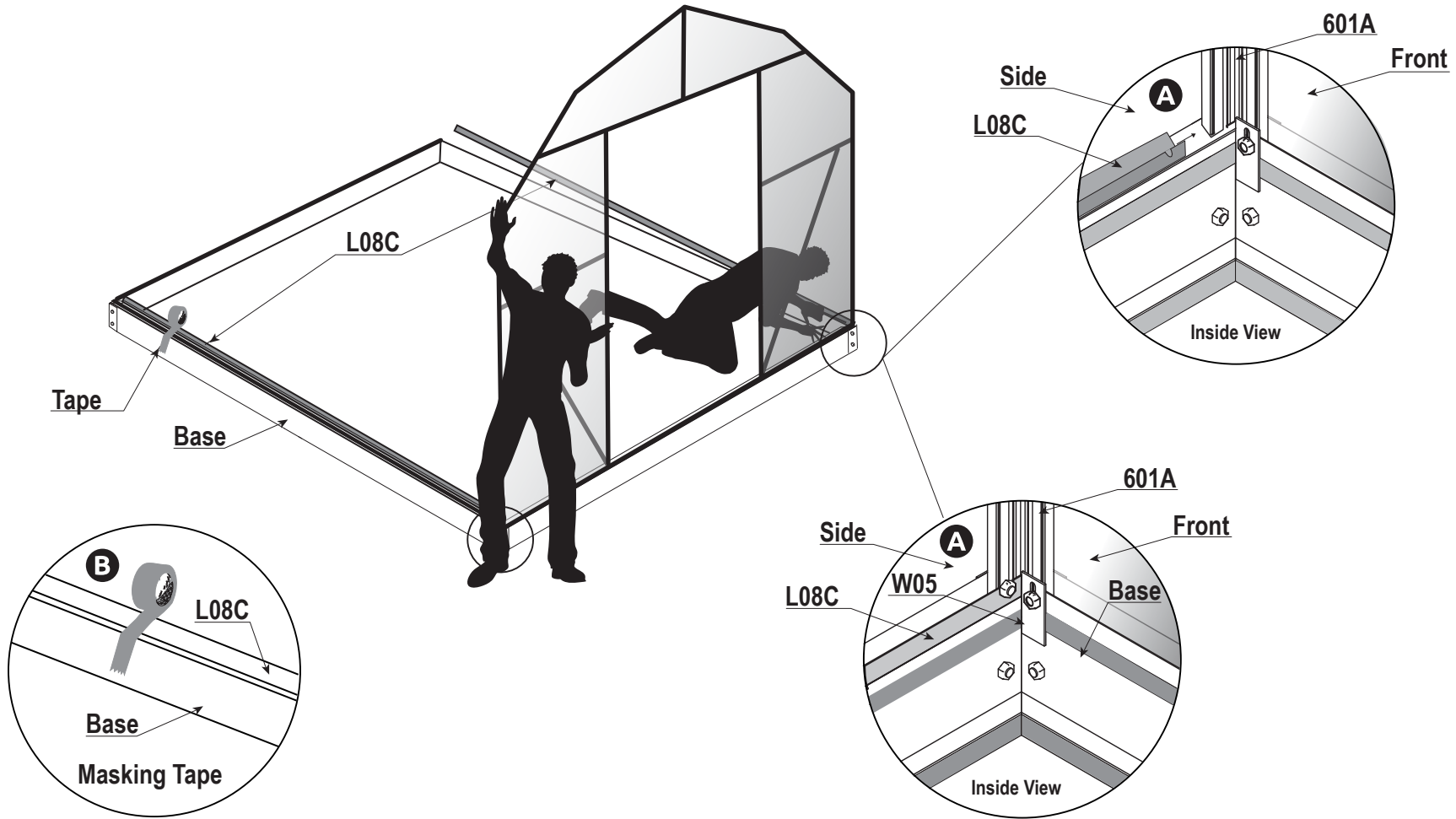

STEP FOUR

# MIDDLE ASSEMBLY CONTINUED

**4.4** Attach **L08C-X** to **601A** with **S04/ML01** on both sides as shown in **A** and **B**.

## STEP FOUR

**4.5** Attach bottom of **L08C-X** to **L08C**, **W05**, and base as shown in **B**. Repeat steps for other side. The **L08C-X** braces will hold the front up vertically without assistance. Make sure the **W05** clip is snug to the base.

**4.6** To install the back section repeat steps **4.1 - 4.5**. Remove tape from **L08C's**.

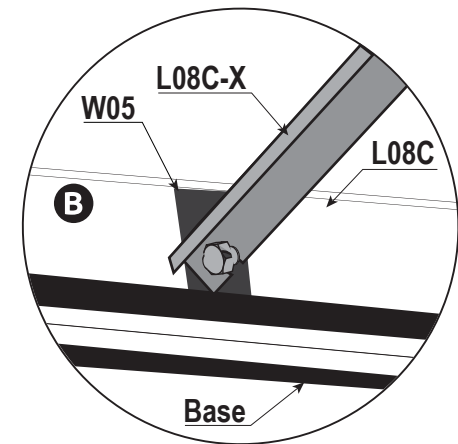
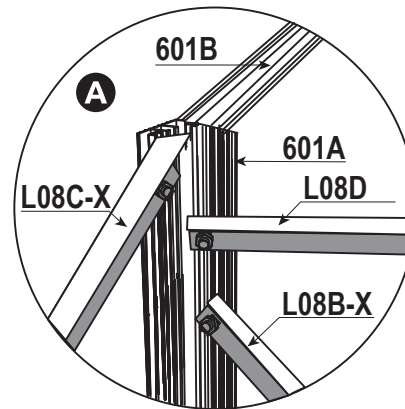
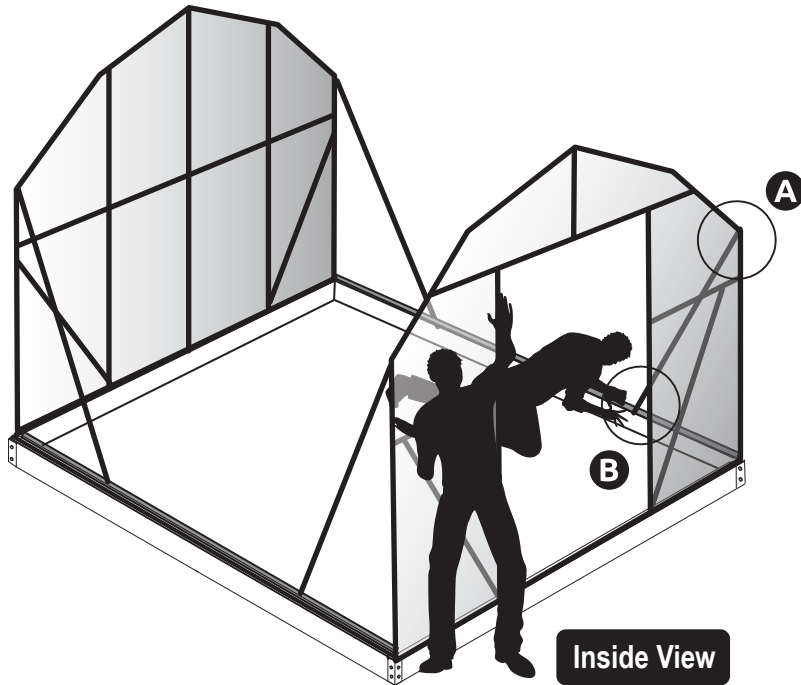

# MIDDLE ASSEMBLY CONTINUED

**4.7** With 2 people, attach the ridge to front and back by sliding into place as shown in **A** and **B**, using **S04/ML01** fasteners attach the **607** to the **601B**'s as shown in **C**.

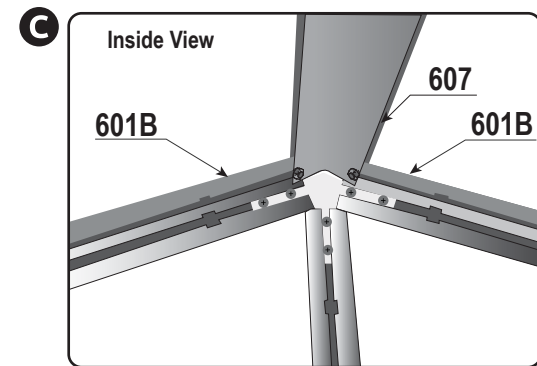
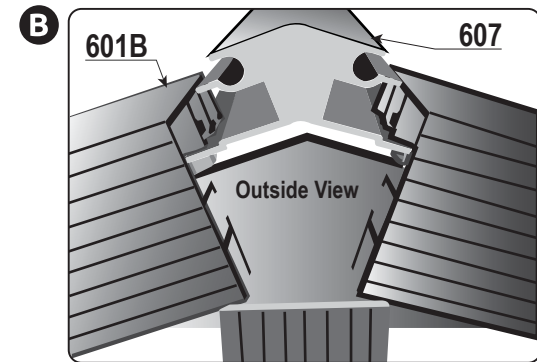
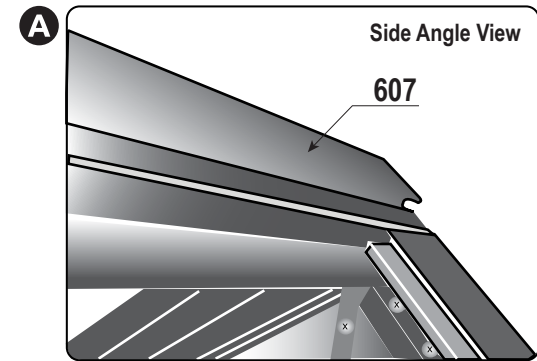
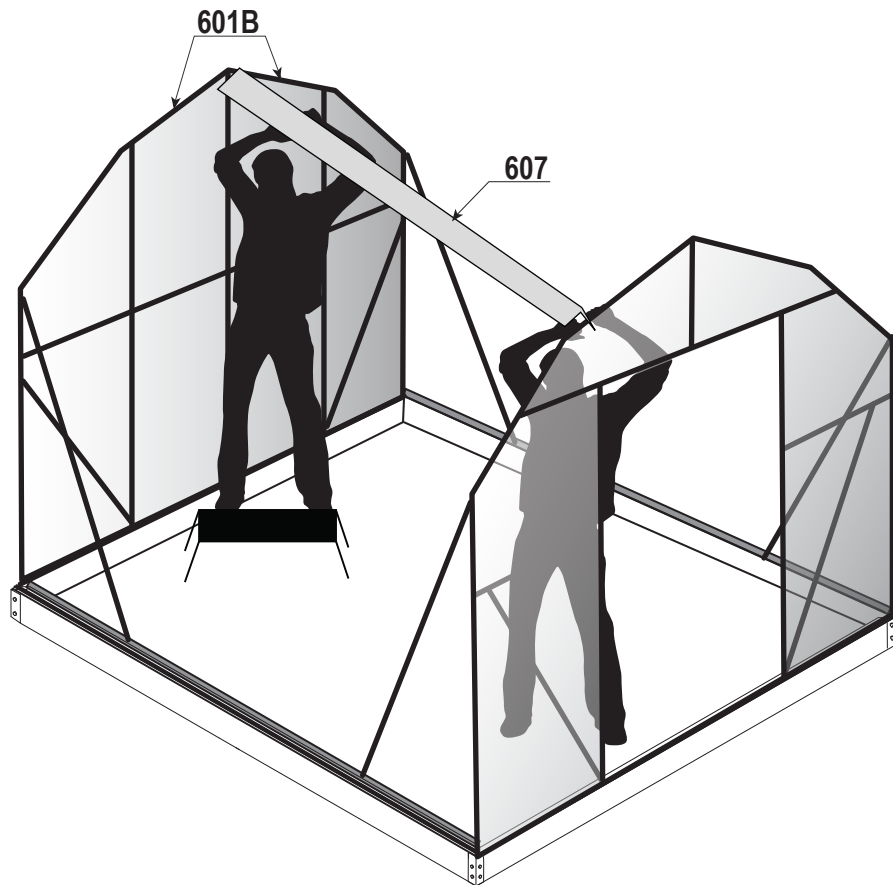

STEP FOUR

# MIDDLE ASSEMBLY CONTINUED

**STEP FOUR**

**4.8** Before you attach the **609** you will need to loosen the **ML01** (nut) attached to the tops of the **L08C-X**.

**Note:** Loosen nuts on only one side at a time, i.e. right front corner, right rear corner. See **A**.

With 2 people proceed to install **609**'s in this order, note that **609** must be installed with groove side down see **C**. Compare with **610** to make sure it will slide into **609** upon completion.

1. With one person holding the **609** level and in position have the other person attach the **609** to the **601B** using **S04/ML01** (nut and bolt). See **B**.

2. Now move the loosened **S04/ML01** (nut and bolt) currently attached to the **601A** upward to firmly secure the **L08C-X**, **609** and **601A** together as shown in **B**.

3. Repeat steps 1 and 2 for the other end of **609**.

4. With one side firmly secured move to the other side and repeat steps 1, 2 and 3.

5. Attach the mid roof **609**'s with **S04/ML01** nut and bolt on both sides see **D**.



Remove only one **L08C-X** at a time. If all **L08C-X**'s are removed, the structure will collapse and cause unwarrantable damage.

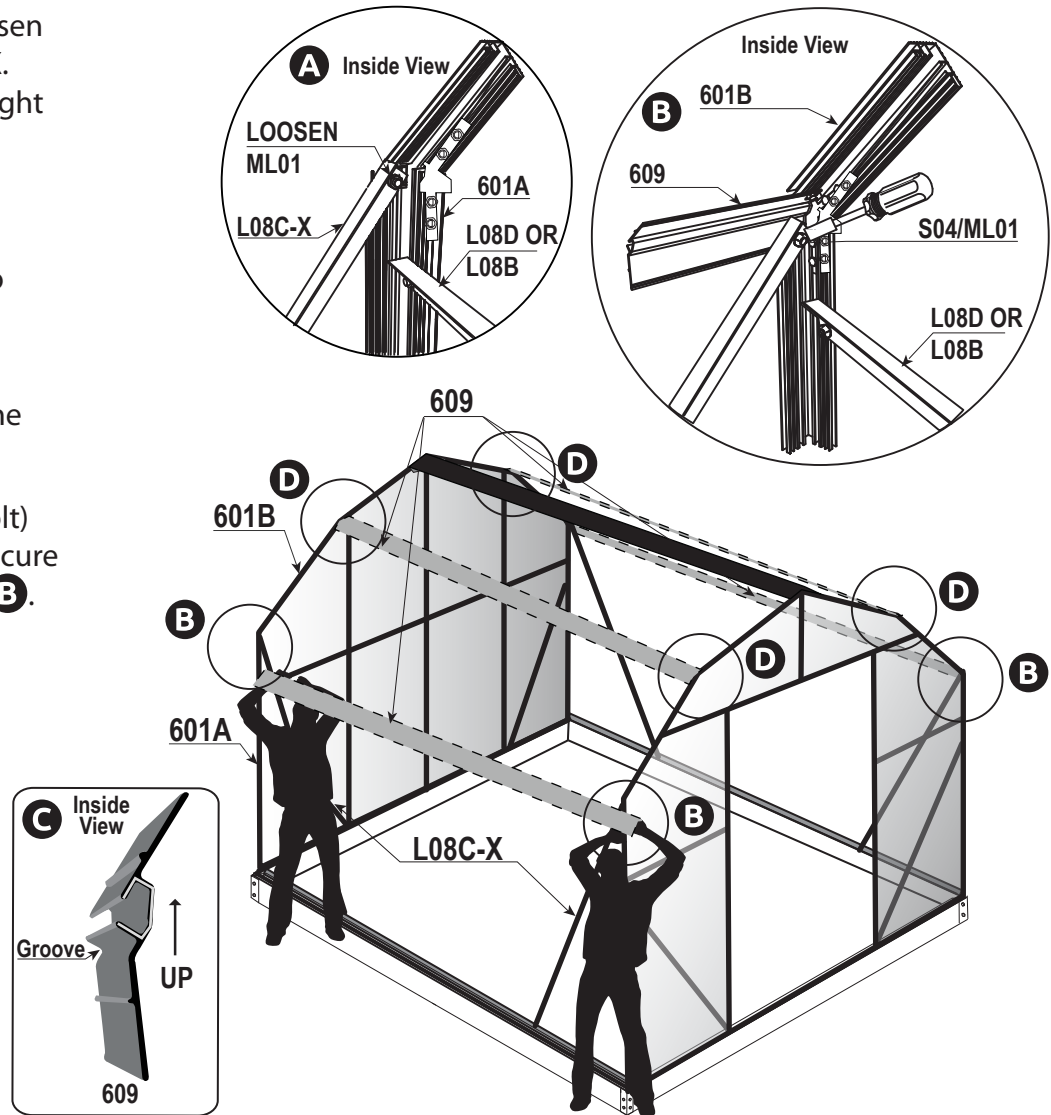



**4.9** Before you attach the **602A's** to the sides of the greenhouse you will need to loosen the **ML01** (nut) attached to the **L08C-X** and **L08C** located at the base. Once the bottom of **L08C-X's** are loosened on one side attach the **602A's** to the sides of the greenhouse in this order.

1. Hold the **602A** in place as shown and attach the top of the **602A** to the **609** using **S04/ML01** (nut and bolt). As shown in **A**.
2. Now attach the bottom of **602A** to the **L08C** and base using a **S04/ML01** (nut and bolt) and **W05** (base clip) as shown in **B**.

**Note:** Where the **L08C-X** reattaches to the **L08C** and the **602A** be sure to secure them with a **W05** (base clip) to the base see **C**.

3. Repeat for the other side.

**4.10** Install plastic strip **606** before inserting polycarbonate sheet **Y7's**, see **D**.

**4.11** After **Y7's** are installed on both sides, loosen bolts attached to **L08C-X** in all upper corners. Using a level, adjust **602A** and tighten bolts. Repeat in every corner until the greenhouse is level. The top edges of **Y7's** will align when greenhouse is level.

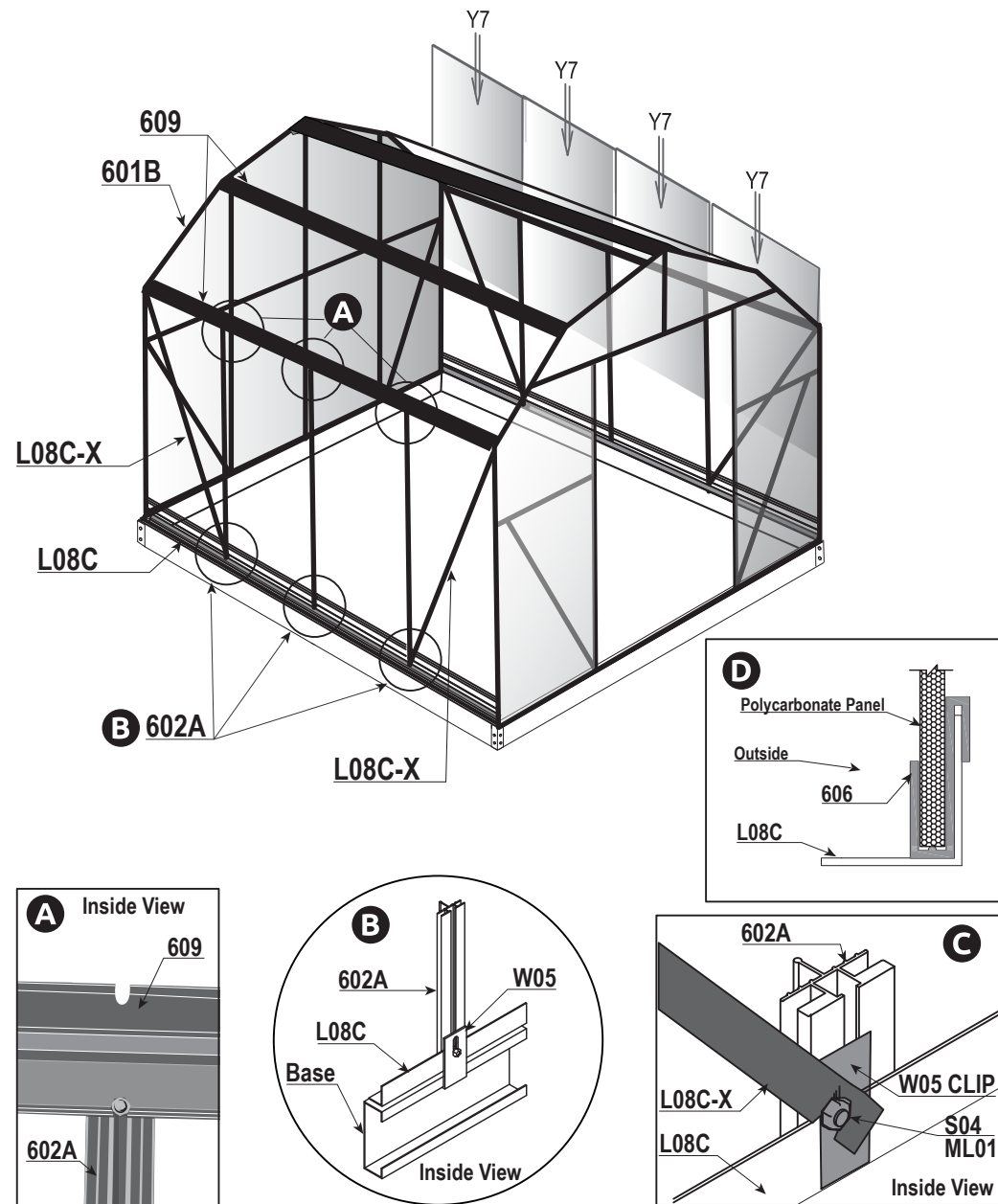

**STEP FOUR**

**4.12** Attach **602B's** to **609's** and **607's** as shown in diagram **A** on both sides of the upper roof section.

Attach (1) **602B** between the (2) **609's**, in the middle only on both sides of roof. **Do not** attach remaining **602B's** to lower roof section until roof vents are attached, see **B**.

**4.13** Insert **Y11** panels to upper roof section then slide the **630** into the groove of the upper **609** as shown to hold **Y11's** in place. See **C** and **D**. Note that you may need to loosen the bottoms of some of the **602B's** to slide the **630** into place as the fit is very tight. Check that all nut and bolt combos are tightened again after installation of **630**.

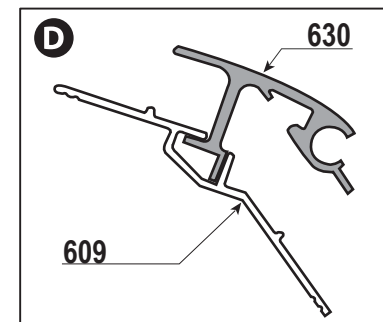
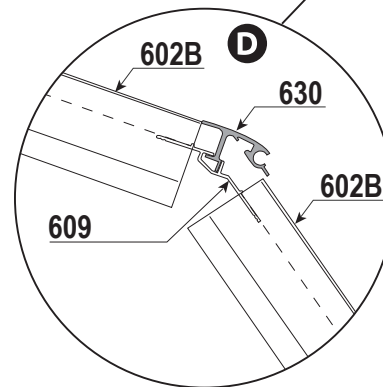
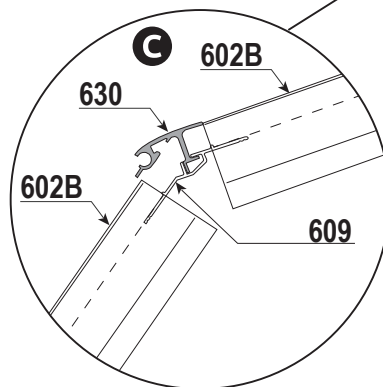
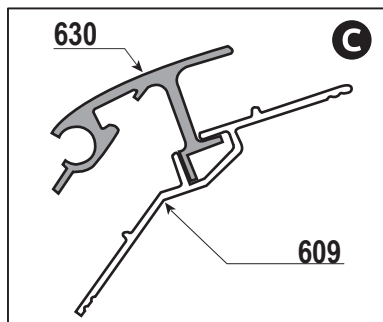
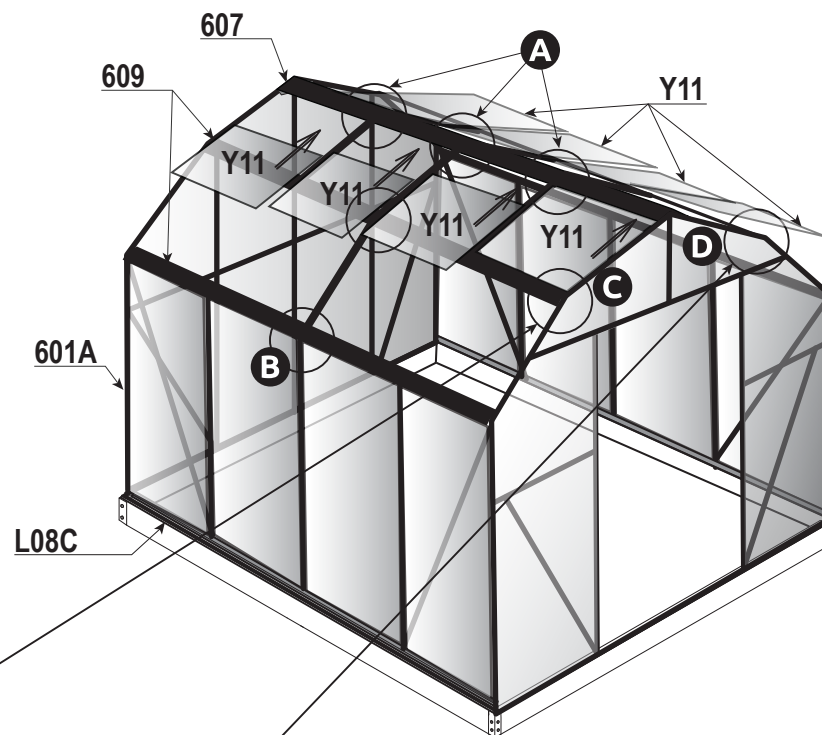

**4.14** Assemble the roof window vents as shown below in **1** and **2**, using the **Z05** Screws attach the **615**, **616**, and **618's** as shown.

**4.15** Insert assembled window into the end of ridge and slide into position. See **A**. Window positions are your discretion however, must be in the middle for support, do not place nearest the front or back as you will need a **602B** support to keep in window vent in place. Vents cannot be next to each other on the 8x12 unit.

**4.16** Attach all remaining **602B's** after roof vents are positioned.

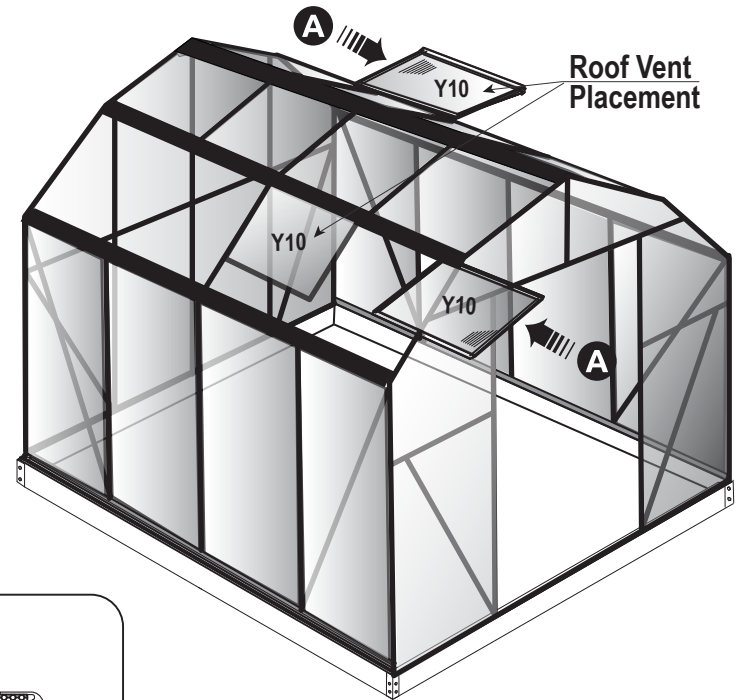

**STEP FOUR**

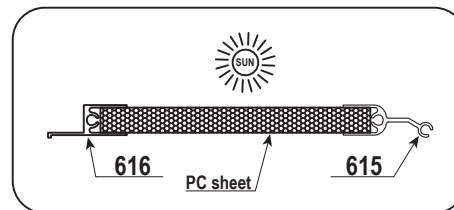
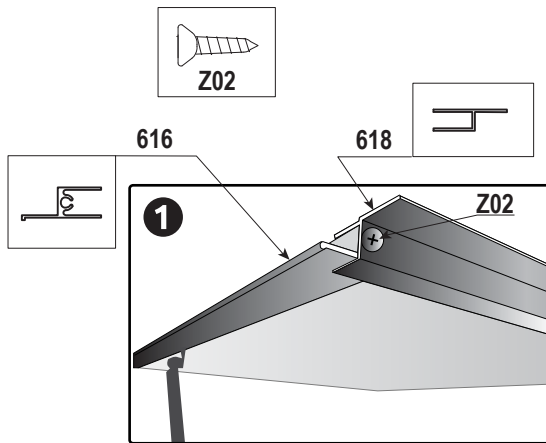

**Note Correct Orientation**

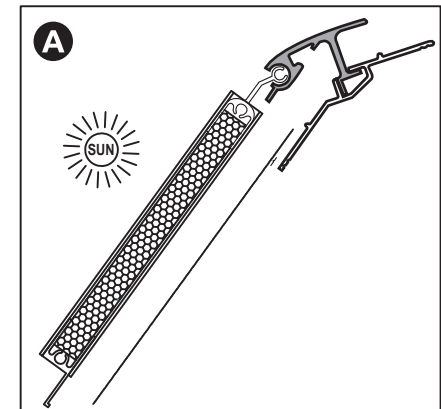
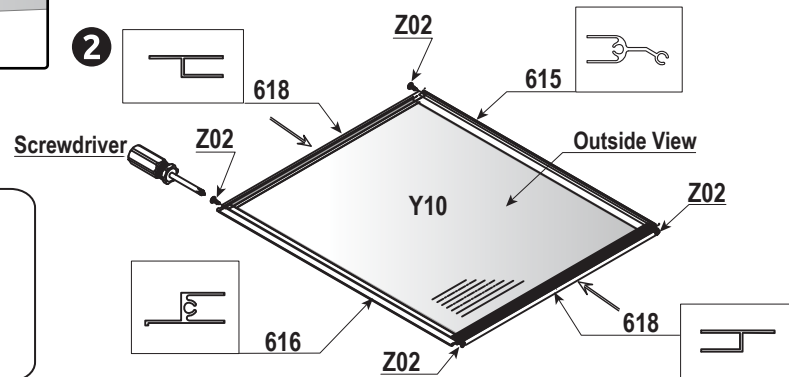

**GRANDIO TIP** Place roof windows in desired location before attaching all **602B's**.

**STEP FOUR**

**4.17** To ensure there is no gap in roof vent position **603C** as shown in **(D)**. Connect **603C** to middle of **602B**'s **W04** bracket as shown in **(A)**.

**4.18** Attach **HQC01** to **616** with the screws see **(B)**, close roof vent and attach the handle onto **HQC02** middle pin (the first two holes of the handle to the first two holes of **HQC02**). Then attach **HQC02** to **603** with **Z04** screws, see **(C)**.

**Note:** If you are installing automatic roof vent openers follow those directions for correct installation.

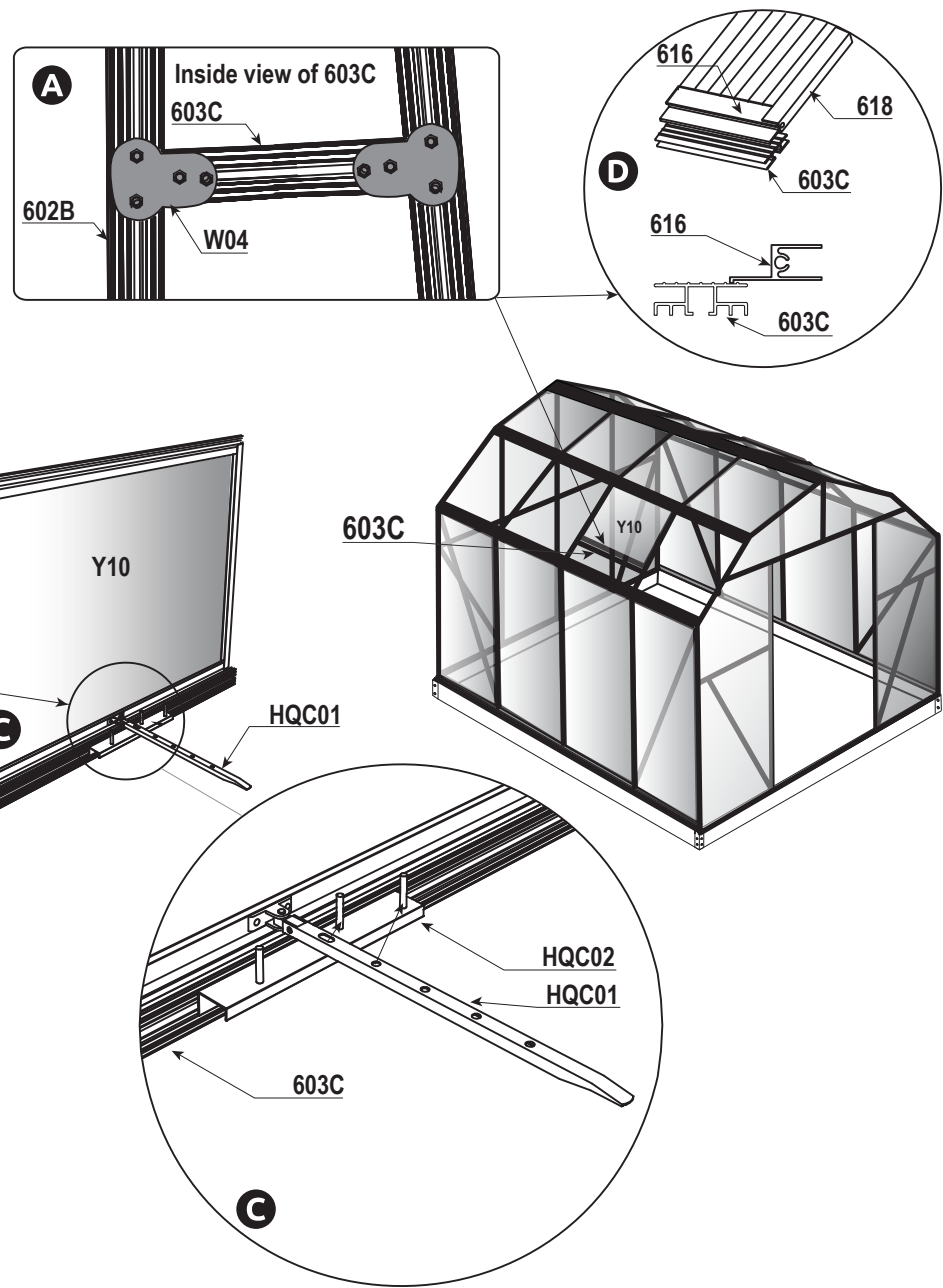

**4.19** Insert polycarbonate sheets **Y8's** and **Y9's** into the lower roof of your greenhouse. Panels may slide out before gutters are in place. You may want to place a piece of tape on the panel to prevent sliding as shown below once the panels are in place.

**4.20** Slide **610** into **609's** groove as shown in diagram **A**. Repeat on both sides. Remove tape after gutter is fully installed.

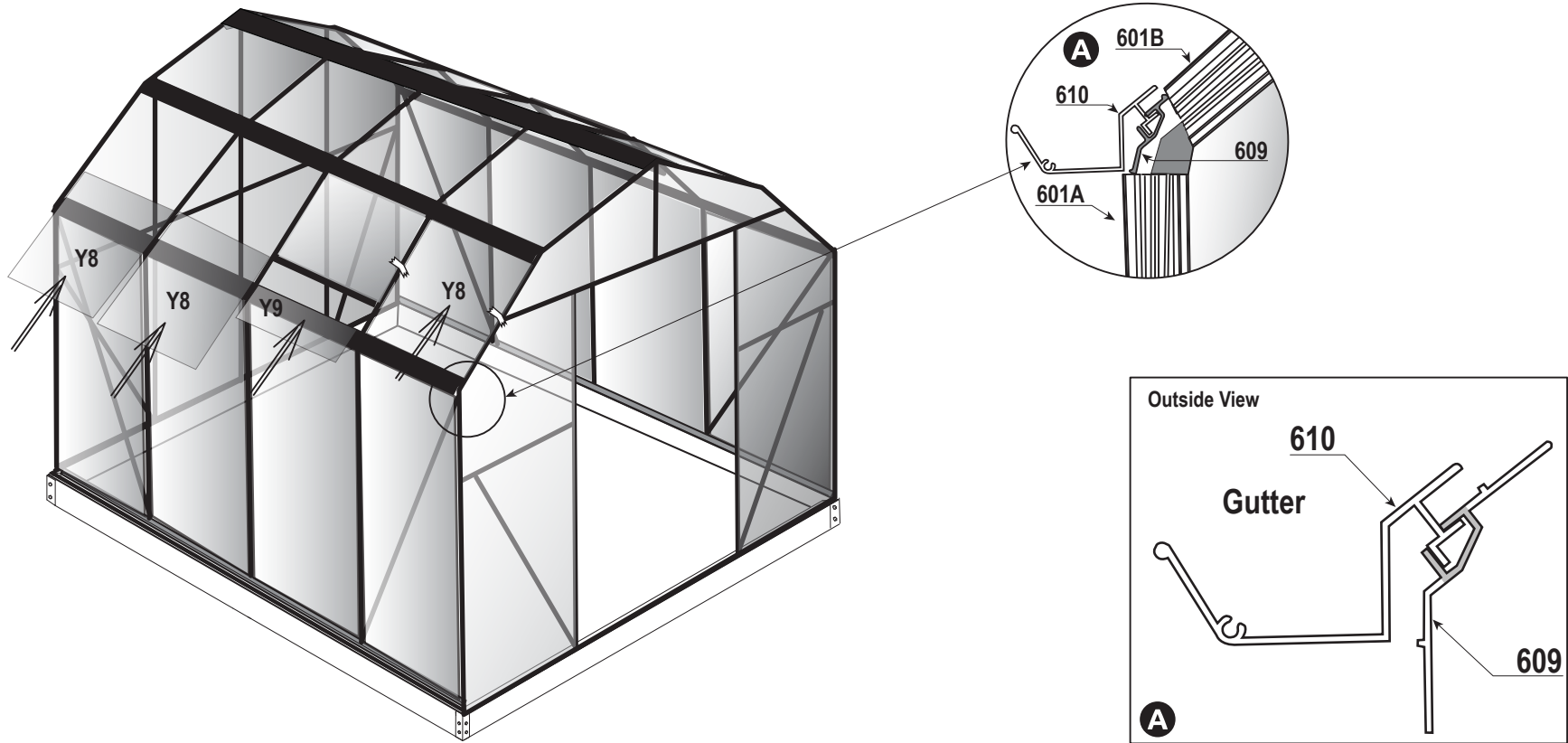

STEP FOUR

**4.21** Attach **JG01**, **JG02**, and **JG03** end caps to the ridge and gutters on both front and back as shown below. Squeeze a small amount of rubberized silicone or construction adhesive into the ends of ridge (**607**) to secure pressure fit end caps (**601**). As show in images on the right. Use **Z03** screws to attach the **JG03** endcaps.

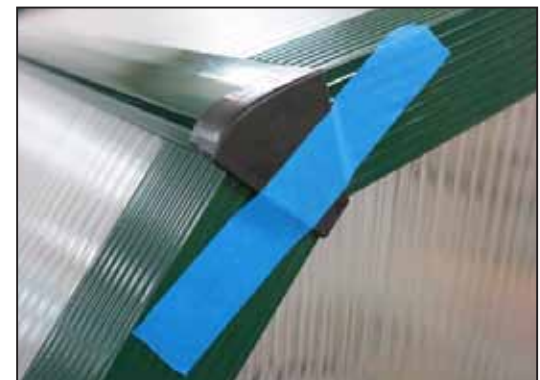
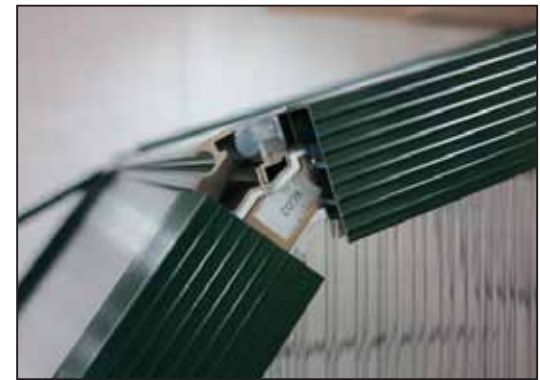
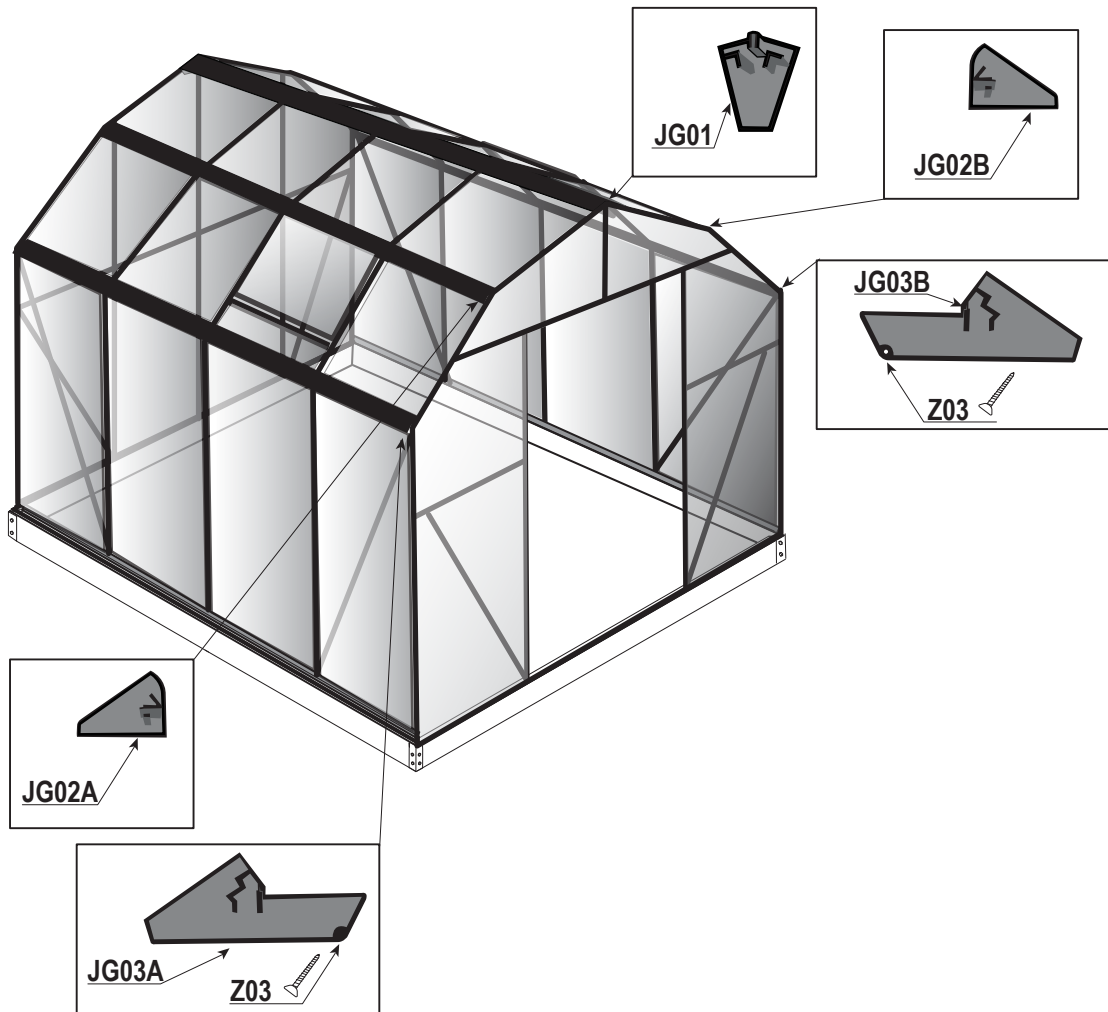

# DOOR ASSEMBLY DIAGRAM

STEP FIVE

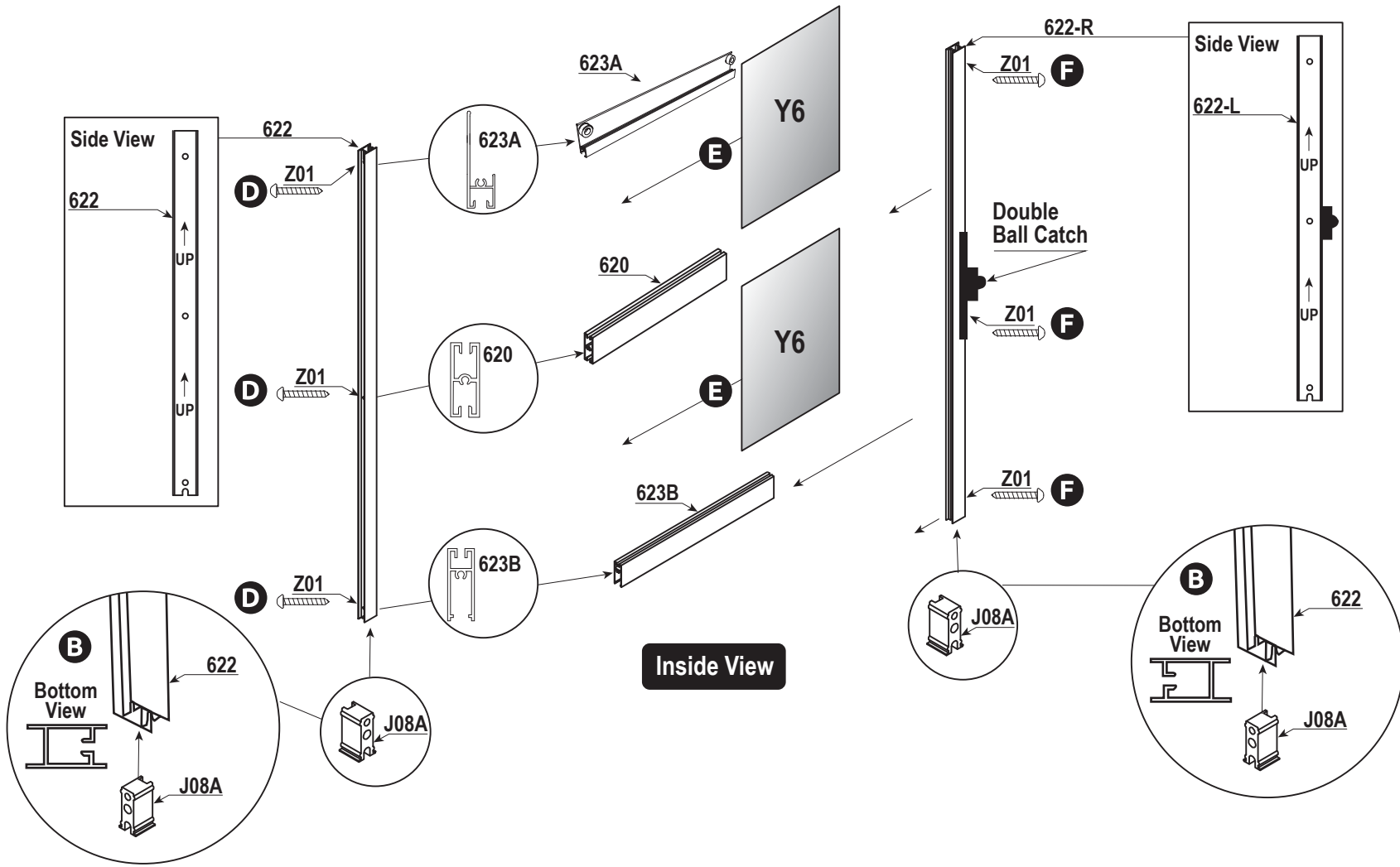

**STEP FIVE**

**5.1** Insert **J08A** into the bottom of the **622**, note the bottom groove is smaller than the top groove of **622**, see **(A)**.

**5.2** Use the **Z01** screws to attach the **622** to the **623B**, **623A** and **620** as shown in **(B)**.

**5.3** Insert **Y6 windows** into position as shown in **(C)**, make sure to match doors up to each by laying out parts for other door now so window panels face the right direction to the sun, and the locks match up.

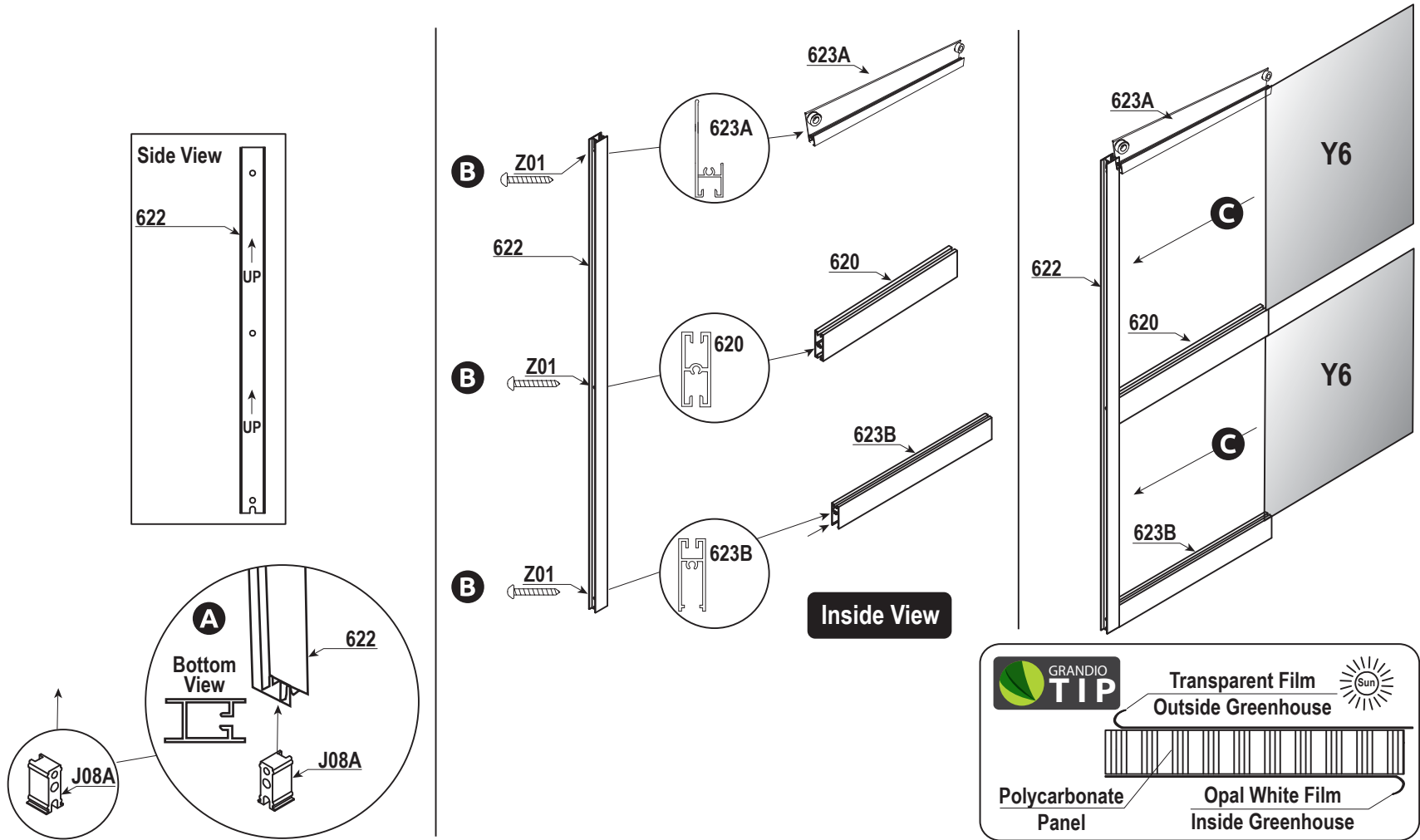



**5.4** Insert **J08A** into the bottom of the **622**, note the bottom has a groove see **A** .

**5.5** Attach the **622** to the **623B**, **623A** and **620** using the **Z01** screws as shown in **B** .

**5.6** Follow the same instructions for the other door making sure that the **622-L** and **622-R** with the double ball catch match up so doors will latch closed and slide properly **C** .

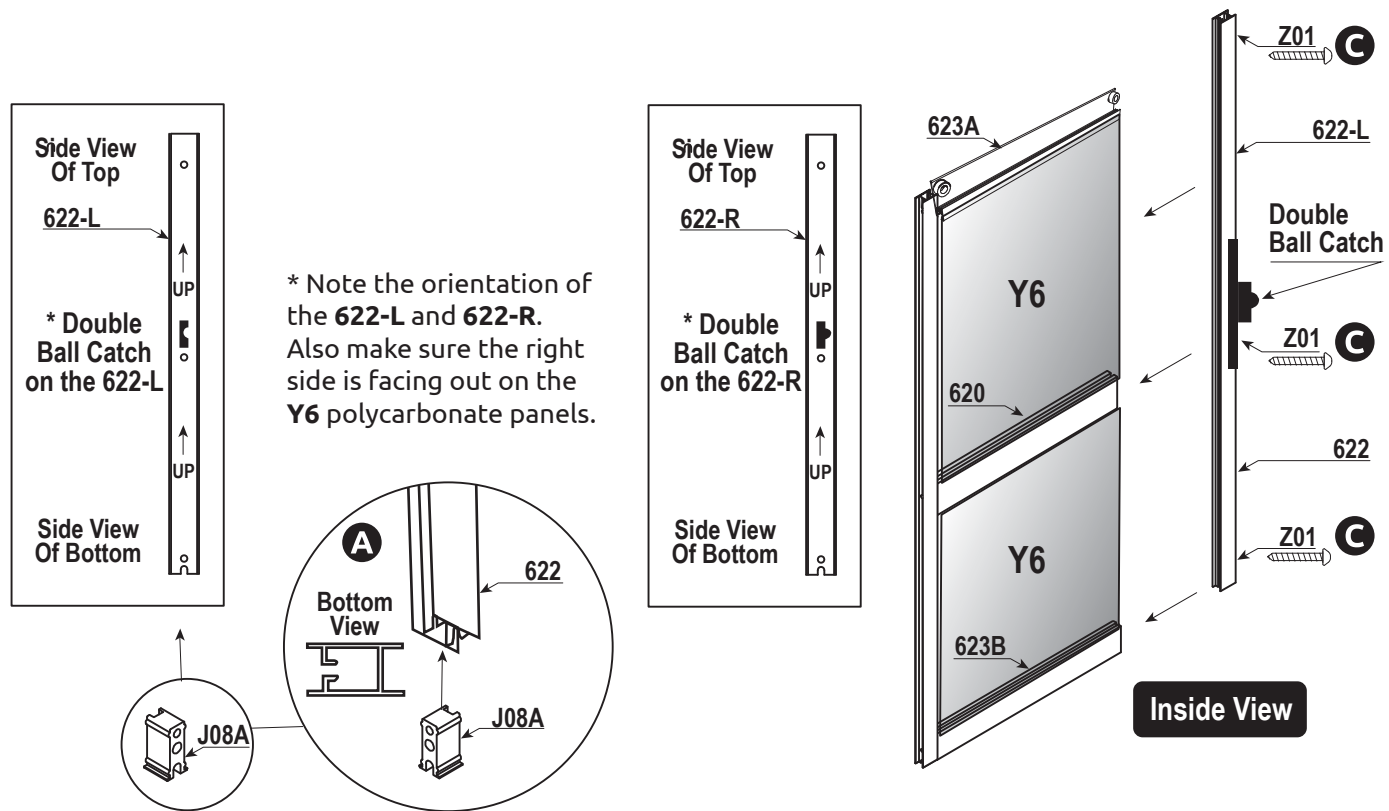

## DOOR ASSEMBLY

**5.7** With one person inside greenhouse line up hanging door track with door header, move bolts on **L21** to line up with bolt holes on door header **603D**. From the inside attach the **S02** nut and bolt set and tighten while holding firmly as high as possible in position from the outside.

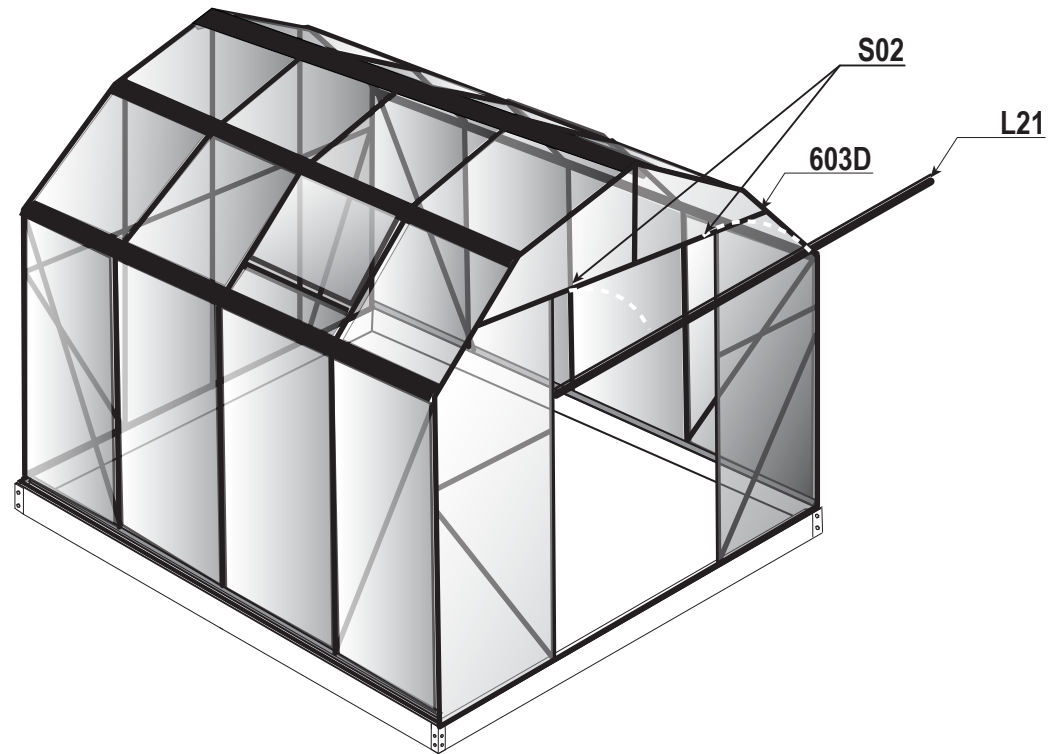

# DOOR INSTALLATION

**5.8** Separately slide the top of the doors in the left and right side of **L21**, see diagram **A**, until they latch in the middle.

**5.9** Attach the door handles **622-HNDL** to both doors using the **622-HNDL-NUT/BOLT** provided to both doors as shown below in **B**, and **C**.

\*\*We included some felt dots in your Grandio Welcome Kit, please apply to the inside bottom edge of the **623B** as shown in **D**, these felt dots will make your doors fit snug and still slide perfectly.

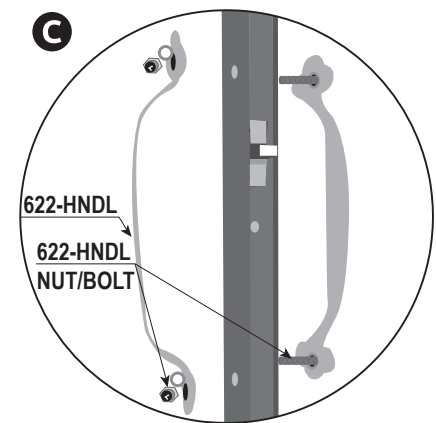
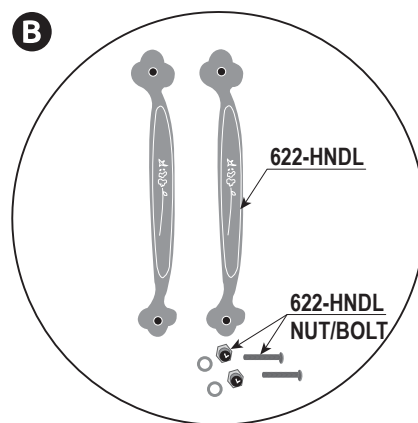
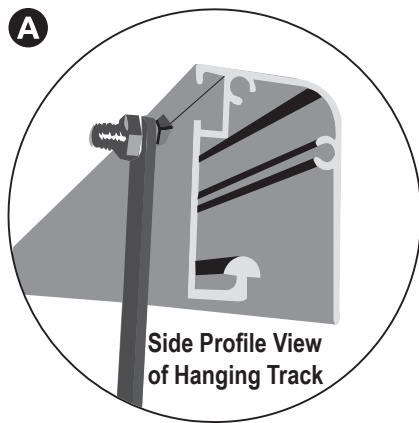
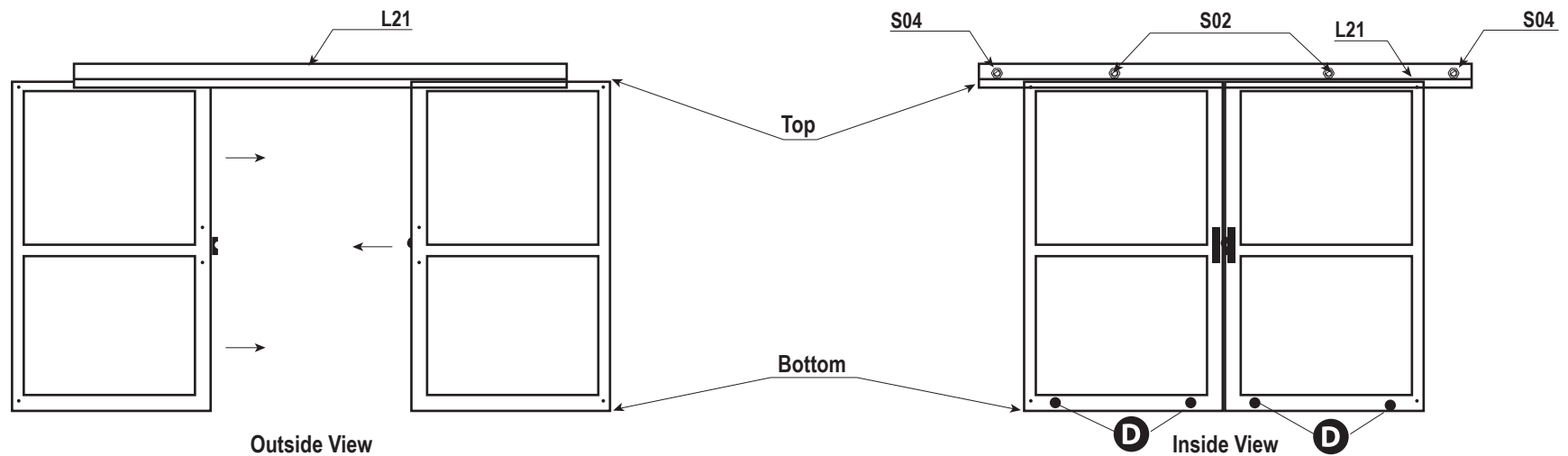

# DOOR INSTALLATION

**5.10** Attach **L28** to **L21** and **601A** as shown below in diagram **A** and **B**. Attach (2) **J07** to the ends of **L21** see **C**. The **L28** should align square to the **601A**.

**5.11** Remove all plastic film from polycarbonate window panels immediately at this step.

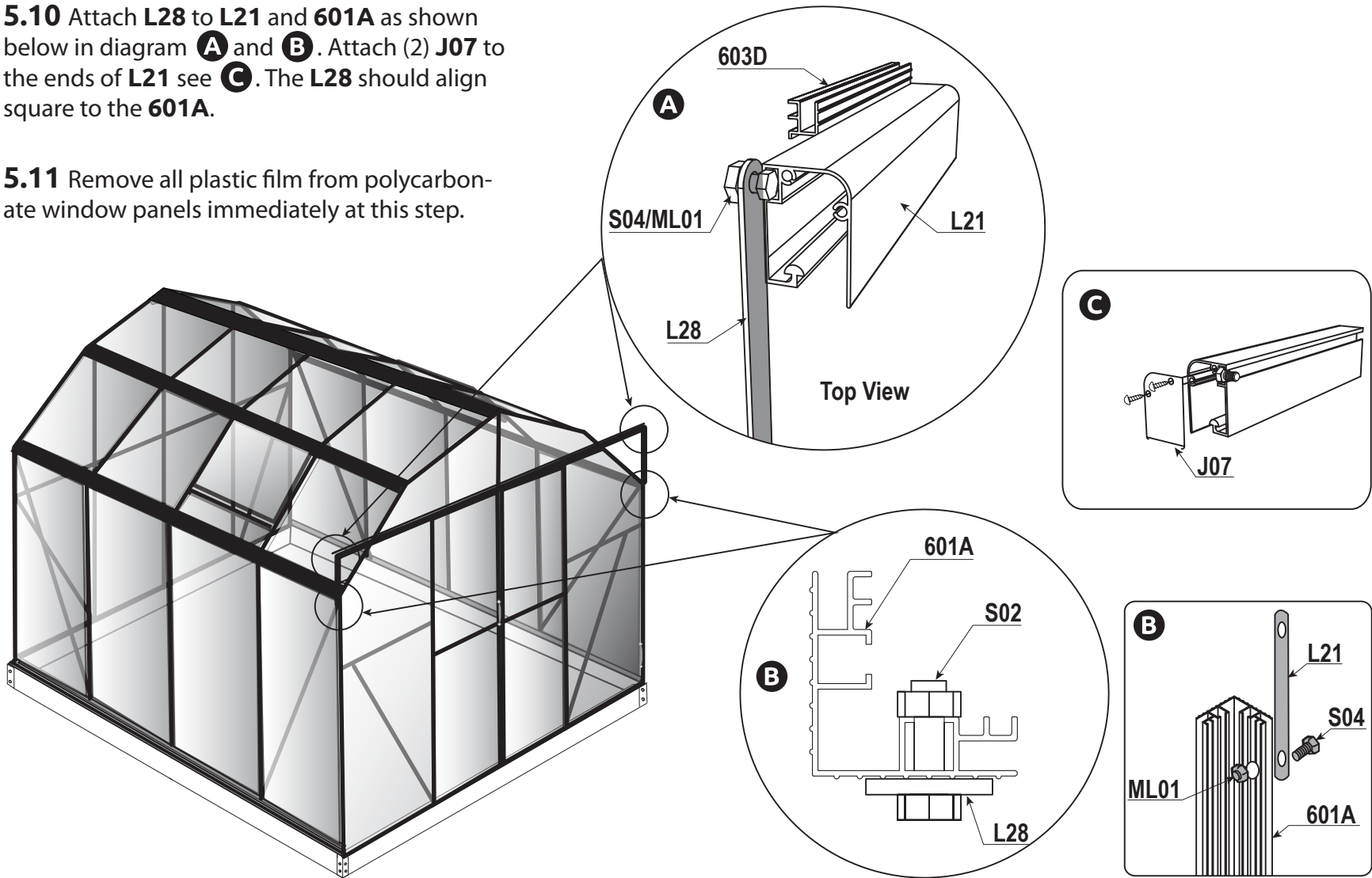

# INTERIOR ROOF SUPPORT ASSEMBLY









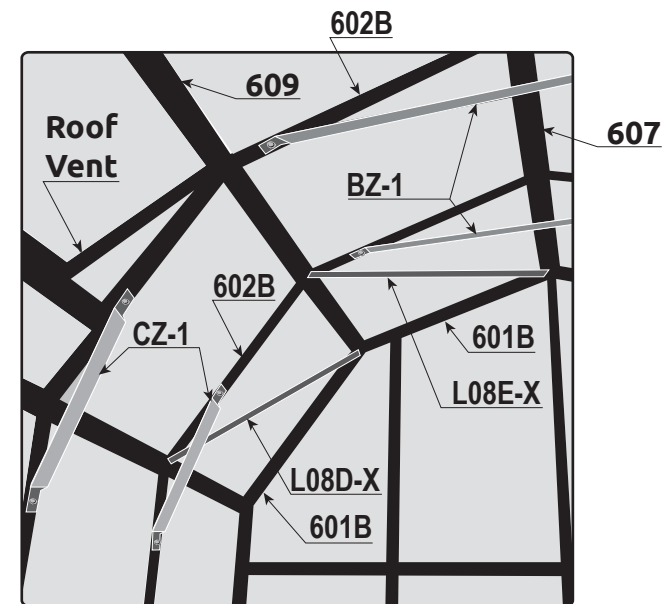
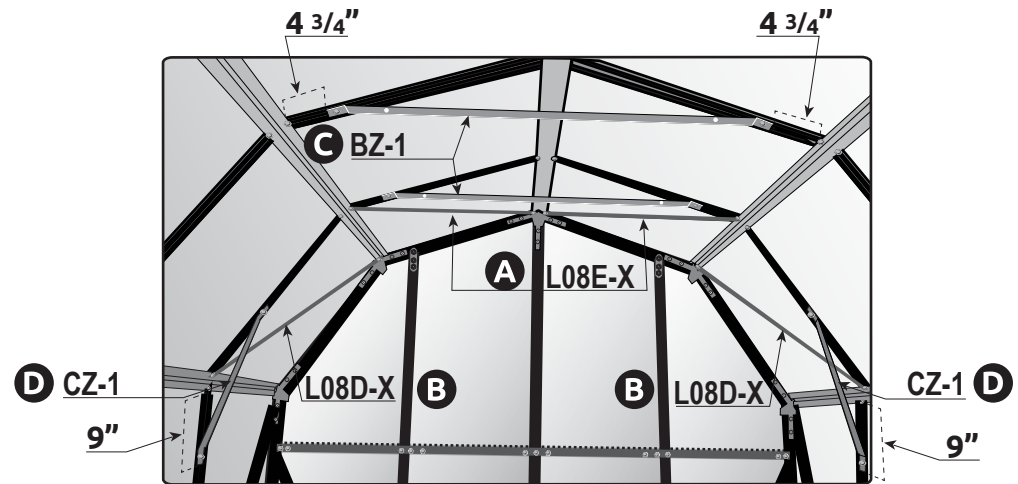

**5.12** Attach the **L08E-X** to the upper roof section as shown with **ML01/S04** fasteners already in place where the **607** meets the **601B**, and the **609** and the **602B** meet see **A**, repeat this on the front section.



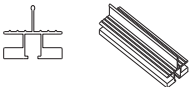
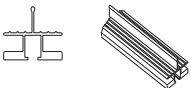
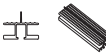

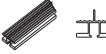
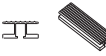
**5.13** Attach the **L08D-X** to the rear lower roof section where **ML01/S04** fasteners are already in place where the **609** and the **602B** meet, and the **609** and the **601B** meet see **B**, repeat on the front section.

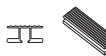



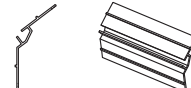
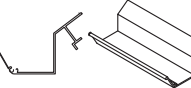

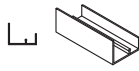
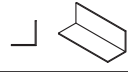
**5.14** Attach the **BZ1's** to the roof line as shown in diagram **C** with the **ML01/S04**. We suggest that you measure up **4 3/4"** from the **609** on both sides to find proper placement of the **BZ1's**.

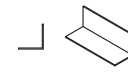
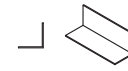
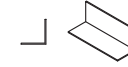



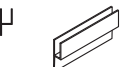
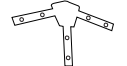
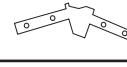
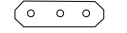
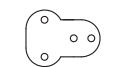

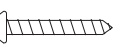





**5.15** Use **CZ1's** to support the interior wall at the eave using the **ML01/S04**. See diagram **D**. We suggest that you measure down **9"** and mark it with a pencil so the base of the **CZ-1** will meet there.



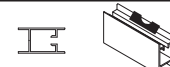
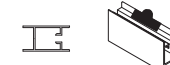







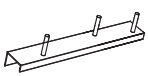

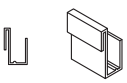



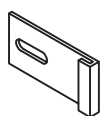



PICTURE	PARTS NO.	GREENHOUSE MODELS	DESCRIPTION	QTY	✓
	601A-B	ALL MODELS	56 5/8" CORNERS	2	
	601A-FL	ALL MODELS	THESE VARY BY LOCATION OF HOLES	1	
	601A-FR	ALL MODELS	THEY WILL BE PACKED TOGETHER	1	
	601B	ALL MODELS	29 1/2" CORNER	8	
	602A	GRA-88	56 6/8" SIDE	6	
		GRA-812	56 6/8" SIDE	10	
	602B	GRA-88	29 1/2" ROOF	12	
		GRA-812	29 1/2" ROOF	20	
	602C	ALL MODELS	90 3/4" BACK	1	
	602D-R	ALL MODELS	83 1/4" BACK	1	
	602D-L	ALL MODELS	80 1/4" BACK	1	
	603D	ALL MODELS	72 1/18" FRONT	1	
	603C	GRA-88	21 7/8" ROOF	8	
		GRA-812	21 7/8" ROOF	10	
	603E	ALL MODELS	18 1/4" FRONT	1	
	604-R	ALL MODELS	70 3/4" FRONT	1	
	604-L	ALL MODELS	THEY WILL BE PACKED TOGETHER	1	

	607	GRA-88	94 5/16" ROOF	1	
		GRA-812	142 5/16" ROOF	1	
	609	GRA-88	94 5/16" ROOF	4	
		GRA-812	142 5/16" ROOFv	4	
	610	GRA-88	94 5/16" SIDE GUTTERS	2	
		GRA-812	142 5/16" SIDE GUTTERS	2	
	630	GRA-88	94 5/16" MID ROOF	2	
		GRA-812	142 5/16" MID ROOF	2	
	619	ALL MODELS	94 5/16" SIDES	1	
	L08A	ALL MODELS	94 5/16" BACK	1	
	L08B	ALL MODELS	THEY WILL BE PACKED TOGETHER	1	
	L08C	GRA-88	94 5/16" SIDES	2	
		GRA-812	142 5/16" SIDES	2	
	L08D	ALL MODELS	24 3/16" FRONT	2	
	L08A-X	ALL MODELS	52 1/4" FRONT	2	







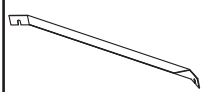

	615	GRA-88	22 3/4" ROOF WINDOW	2	
		GRA-812	22 3/4" ROOF WINDOW	4	
	616	GRA-88	22 3/4" ROOF WINDOW	2	
		GRA-812	22 3/4" ROOF WINDOW	4	
	618	GRA-88	19 9/16" ROOF WINDOW	4	
		GRA-812	19 9/16" ROOF WINDOW	8	
	WG01	ALL MODELS	FRONT & BACK	2	
	WG02	ALL MODELS	FRONT & BACK	8	
	W04-2	ALL MODELS	FRONT	4	
	W04	GRA-88	ROOF	5	
		GRA-812	ROOF	9	
	W04-1	ALL MODELS	BACK	2	
	W11	ALL MODELS	#2 PHILLIPS SCREWDRIVER	1	
	Z01	ALL MODELS	4X30	13	
	Z02	GRA-88	4.6X16 MM	9	
		GRA-812	4.6X16 MM	17	
	Z03	ALL MODELS	3X25 MM	4	







	L08B-X	ALL MODELS	51 1/8" BACK	2	
	L08C-X	ALL MODELS	61" SIDES	4	
	L08D-X	ALL MODELS	37 3/4" ROOF	4	
	L08E-X	ALL MODELS	37 5/8" ROOF	4	
	620	ALL MODELS	21 7/16" DOOR	2	
	L21	ALL MODELS	95 1/2" DOOR	1	
	622	ALL MODELS	70 1/4" DOOR ALL PACKED TOGETHER	2	
	622-L	ALL MODELS	70 1/4" DOOR NOTE HOODLE LOCK	1	
	622-R	ALL MODELS	70 1/4" DOOR NOTE HOODLE LOCK	1	
	623A	ALL MODELS	21 1/2" DOOR	2	
	623B	ALL MODELS	21 5/16" DOOR	2	
	J04	ALL MODELS	Discard Rollers Not for use in this model	4	
	J07	ALL MODELS	DOOR ENDCAPS	2	
	J08A	ALL MODELS	DOOR	4	
	L28	ALL MODELS	19 3/4"	2	

	HQC01	GRA-88	ROOF	2	
		GRA-812	ROOF	4	
	HQC02	GRA-88	ROOF	2	
		GRA-812	ROOF	4	
	W13	ALL MODELS	10 MM NUT DRIVER	1	
	606	GRA-88	WINDOW SEAL	14	
		GRA-812	WINDOW SEAL	18	
	BASE	GRA-88	BASE SECTION	4	
		GRA-812	72" 97"	4 2	
	W07	GRA-88	MID BASE ANCHOR	0	
		GRA-812	MID BASE ANCHOR	2	
	W08	GRA-88	MID BASE BACK PLATE	0	
		GRA-812	MID BASE BACK PLATE	2	
	W05	GRA-88	BASE CLIP	15	
		GRA-812	BASE CLIP	19	
	W06	ALL MODELS	CORNER ANCHOR	4	
	622-HNDL	ALL MODELS	DOOR HANDLES	4	
	622-HNDL NUT/BOLT	ALL MODELS	PACKED TOGETHER	4	

	S02	ALL MODELS	6X20 MM	4	
	S03/M01	GRA-88	M6X10	17	
		GRA-812	M6X10	25	
	ML01/S04	GRA-88	M6X14	150	
		GRA-812	M6X14	195	
	S05	ALL MODELS	PHILLIPS SCREWS	45	
	JG01	ALL MODELS	FRONT & BACK	2	
	JG02 A/B	ALL MODELS	FRONT & BACK	2/2	
	JG03 A/B	ALL MODELS	FRONT & BACK	2/2	
	BZ-1	GRA-88	47 1/4" CENTRAL ROOF SUPPORT	3	
		GRA-812	47 1/4" CENTRAL ROOF SUPPORT	5	
	CZ-1	GRA-88	23 5/8" LOWER ROOF SUPPORT	6	
		GRA-812	23 5/8" LOWER ROOF SUPPORT	10	



	Y1	ALL MODELS	FRONT & BACK PANEL	6	
	Y2-1	ALL MODELS	FRONT PANEL	1	
	Y2-2	ALL MODELS	FRONT PANEL	1	
	Y3-1	ALL MODELS	FRONT PANEL	1	
	Y3-2	ALL MODELS	FRONT PANEL	1	
	Y4-1	ALL MODELS	BACK PANEL	1	
	Y4-2	ALL MODELS	BACK PANEL	1	
	Y5-1	ALL MODELS	BACK PANEL	1	
	Y5-2	ALL MODELS	BACK PANEL	1	

	Y6	ALL MODELS	DOOR PANEL	4	
	Y7	GRA-88	SIDE PANEL	8	
		GRA-812	SIDE PANEL	12	
	Y8	GRA-88	ROOF PANEL	6	
		GRA-812	ROOF PANEL	8	
	Y9	GRA-88	ROOF VENT PANEL	2	
		GRA-812	ROOF VENT PANEL	4	
	Y10	GRA-88	BELOW ROOF VENT	2	
		GRA-812	BELOW ROOF VENT	4	
	Y11	GRA-88	ROOF PANEL	8	
		GRA-812	ROOF PANEL	12	



# Grandio Greenhouse Limited Lifetime Warranty

- 1.** Grandio Greenhouses are warranted to the original purchaser to be free from defects in material or workmanship for ten years from the date of original retail purchase on all plastic panels. Additionally the aluminium frame is warranted for life. The word "defects" is defined as imperfections that impair the use of the product.
- 2.** Defects resulting from misuse, abuse or negligence will void this warranty. This warranty does not cover defects due to improper installation, alteration of accident. This warranty does not cover damage caused by vandalism, rusting, "acts of nature" or any other event beyond the control of the manufacturer.
- 3.** This warranty is nontransferable and is expressly limited to the repair or replacement of defective product if the product is defective within the terms of this warranty, Grandio Greenhouses will repair or replace defective parts at no cost to the purchaser. Shipping charges to and from the factory or distribution center are not covered and are the responsibility of the purchaser. Labor charges and related expenses for removal, installation or replacement of the greenhouse or its components are not covered under this warranty.
- 4.** This warranty does not cover scratching or scuffing of the product that may result from normal usage. In addition, defects resulting from intentional damage, negligence, unreasonable use will void this warranty.
- 5.** Liability for incidental or consequential damages is excluded to the extent permitted by law. While every attempt is made to embody the highest degree of safety in all equipment, freedom from injury cannot be guaranteed. The user assumes all risk of injury resulting from the use of this product. All merchandise is sold on this condition, and no representative of the company may waive or change this policy.
- 6.** This product is not intended for institutional or commercial use; Grandio Greenhouses does not assume any liability for such use.
- 7.** This warranty is expressly in lieu of all other warranties, expressed or implied, including warranties of merchantability for use to extent permitted by Federal and State Law. Neither Grandio Greenhouses nor any representative assumes any other liability in connection with this product. This warranty gives you specific legal rights, and you may also have other rights that vary from state to state.



# GRANDIO

G R E E N H O U S E S

Model GRA-88BR-GR & Model GRA-812BR-GR

## **GREENHOUSE USER MANUAL KEEP IN A SAFE PLACE FOR REFERENCE**

CONTACT US IF YOU NEED HELP  
OR  
HAVE MISSING OR DAMAGED PARTS

**GRANDIOGREENHOUSES.COM**

**BACKYARD LIVING SOURCE, INC.  
9543 W. EMERALD ST., SUITE 101  
BOISE, ID 83704  
1-866-928-3150**