



KRAMER ELECTRONICS LTD.

USER MANUAL

MODEL:

914
Power Amplifier

P/N: 2900-300280 Rev 1



914 Power Amplifier Quick Start Guide

This guide helps you install and use your product for the first time. For more detailed information, go to http://www.kramerelectronics.com/support/product_downloads.asp to download the latest manual or scan the QR code on the left.

Step 1: Check what's in the box

- 914 Audio Amplifier
- 4 Rubber feet
- 1 Power cord
- 1 Quick Start sheet

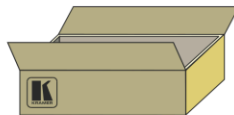

Save the original box and packaging materials in case you need to return your **914** for service.

Step 2: Install the 914

Attach the rubber feet and place on a table or mount the **914** in a rack (using an optional RK-1 rack mount).

Step 3: Connect the inputs and output

Always switch off the power on each device before connecting it to your **914**.

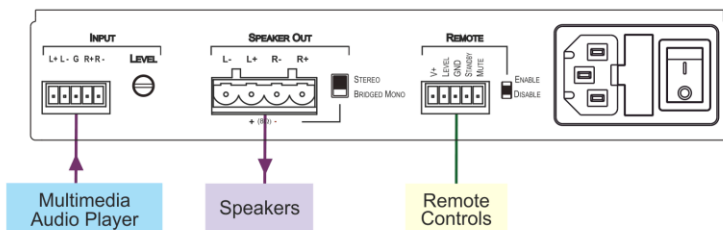

Always use Kramer high-performance cables for connecting AV equipment to the **914**.

Step 4: Connect the power

Connect the power cord to the **914** and plug it into the mains electricity.



Step 5: Operate the 914

Operate the **914** using the remote controls.

Contents

1	Introduction	1
2	Getting Started	2
2.1	Achieving the Best Performance	2
3	Overview	3
3.1	Energy Star	3
4	Defining the 914 Power Amplifier	5
5	Connecting the 914	7
5.1	Connecting the 914	7
5.2	Connecting the Remote Controls	8
5.3	Connecting the Speakers	9
5.4	Connecting a Balanced and Unbalanced Stereo Audio Input	10
6	Operating the 914	11
6.1	Stereo and Bridged Mono Modes	11
6.2	Operating the 914 Remotely	11
7	Technical Specifications	12

Figures

Figure 1:	914 Power Amplifier Front Panel	5
Figure 2:	914 Power Amplifier Rear Panel	6
Figure 3:	Connecting the 914 Power Amplifier	8
Figure 4:	Connecting Remote Control Switches to the 914	8
Figure 5:	Connecting Speakers to the 914 Power Amplifier	9
Figure 6:	Balanced Stereo Audio Connection	10
Figure 7:	Unbalanced Stereo Audio Input Connection	10

1 Introduction

Welcome to Kramer Electronics! Since 1981, Kramer Electronics has been providing a world of unique, creative, and affordable solutions to the vast range of problems that confront the video, audio, presentation, and broadcasting professional on a daily basis. In recent years, we have redesigned and upgraded most of our line, making the best even better!

Our 1,000-plus different models now appear in 14 groups that are clearly defined by function: GROUP 1: Distribution Amplifiers; GROUP 2: Switchers and Matrix Switchers; GROUP 3: Control Systems; GROUP 4: Format/Standards Converters; GROUP 5: Range Extenders and Repeaters; GROUP 6: Specialty AV Products; GROUP 7: Scan Converters and Scalers; GROUP 8: Cables and Connectors; GROUP 9: Room Connectivity; GROUP 10: Accessories and Rack Adapters and GROUP 11: Sierra Products; GROUP 12: Digital Signage; and GROUP 13: Audio, and GROUP 14: Collaboration.

Congratulations on purchasing your Kramer **914** *Power Amplifier*, which is ideal for the following typical applications:

- Presentation rooms and multimedia applications for local audio amplification
- Personal audio listening (for example, a PC and portable CD player)

2 Getting Started

We recommend that you:

- Unpack the equipment carefully and save the original box and packaging materials for possible future shipment
- Review the contents of this user manual
Use Kramer high performance high resolution cables.
Use only the power cord that is supplied with this machine



Go to http://www.kramerelectronics.com/support/product_downloads.asp to check for up-to-date user manuals, application programs, and to check if firmware upgrades are available (where appropriate).

2.1 Achieving the Best Performance

To achieve the best performance:

- Use only good quality connection cables (we recommend Kramer high-performance, high-resolution cables) to avoid interference, deterioration in signal quality due to poor matching, and elevated noise levels (often associated with low quality cables)
- Do not secure the cables in tight bundles or roll the slack into tight coils
- Avoid interference from neighboring electrical appliances that may adversely influence signal quality
- Position your Kramer **914** away from moisture, excessive sunlight and dust



This equipment is to be used only inside a building. It may only be connected to other equipment that is installed inside a building.

3 Overview

The Kramer **914** is a high performance power amplifier that accepts a balanced stereo audio input on a 5-pin terminal block and converts the signal into a differential stereo audio output for speakers on a 4-pin terminal block.

The **914 Power Amplifier** features:

- Input level sensitivity adjustment
- 10K Remote control
- Stereo and bridged mono modes
- Left and right channel monitoring LEDs

The **914 Power Amplifier** is housed in a Kramer 1/2U enclosure.

3.1 Energy Star

The **914 Power Amplifier** meets the ENERGY STAR audio specification and draws less than 1 watt while in standby mode; it offers a sleep mode, auto power-down, and meets the specified efficiency requirements.

To comply with the Energy Star requirements the **914** provides the following operational modes:

1. On Mode—Where the **914** is connected to a mains power source, has been activated and is capable of providing amplification. The common terms “active”, “in-use” and “normal operation” also describe this mode.
 - Active State—A state within On Mode in which the **914** provides amplification
 - Standby State—A state within On Mode in which the **914** does not provide amplification

2. Standby Mode—where the **914** is connected to a mains power source, is incapable of providing amplification, and offers the following user oriented or protective functions:
 - It facilitates the activation of other modes (including activation of On Mode) by a remote switch (including remote, contact-closure switches), and timer
 - The front panel's information LEDs continuously display the status of the device
 - The sensor-based functions function continuously. For purposes of this specification, Sleep Mode is defined as the time when the product is connected to a power source, does not produce sound, and is waiting to be switched to On Mode by a direct or indirect signal
3. Off Mode—where the product is connected to a mains power source, is not providing amplification, and cannot be switched into any other mode except by user actuation of a manual power switch.

4 Defining the 914 Power Amplifier

Figure 1 defines the front panel of the **914 Power Amplifier**.

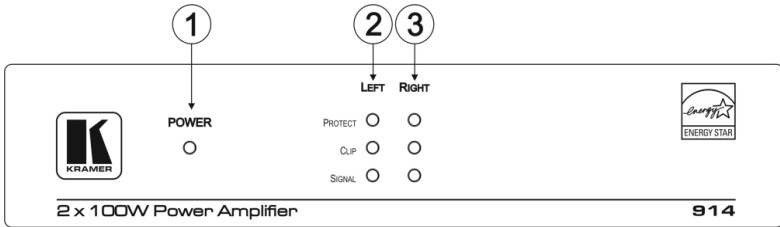

Figure 1: 914 Power Amplifier Front Panel

#	Feature	Function	
1	ON LED	Lights green when the device is powered on Lights red when the device is in standby mode	
2	LEFT Channel	PROTECT LED	Lights red when the left channel signal protection is activated
		CLIP LED	Lights yellow when the left channel signal is clipping
		SIGNAL LED	Lights green when there is a signal present on the left channel
3	RIGHT Channel	PROTECT LED	Lights red when the right channel signal protection is activated
		CLIP LED	Lights yellow when the right channel signal is clipping
		SIGNAL LED	Lights green when there is a signal present on the right channel

Figure 2 defines the rear panel of the 914 Power Amplifier.

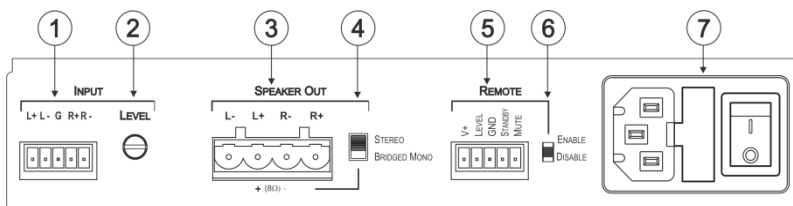

Figure 2: 914 Power Amplifier Rear Panel

#	Feature		Function
1	INPUT	L+ L- G R+ R- 5-pin Terminal Block	Connect to a balanced, stereo, analog audio source
2		LEVEL Trimmer	Turn clockwise to increase the input level and anticlockwise to decrease the input level
3	SPEAKER OUT	L- L+ R- R+ 4-pin Terminal Block	Connect to the speakers (see Section 5.2)
4		STEREO BRIDGED MONO Switch	Push switch up to operate in standard stereo mode; push switch down to operate in bridged mono mode (see Section 5.2)
5	REMOTE	V+ LEVEL GND STANDBY MUTE 5-pin Terminal Block	Connect to the output level control potentiometer (10kΩ), and the remote Standby and Mute switches (see Section 5.2)
6		ENABLE DISABLE Switch	When the switch is up, the remote volume control is enabled; when the switch is down, the remote volume control is disabled
7	Mains Power Unit		Connect to the mains power
			Mains Fuse for protecting the 914
			Switch for turning the device on and off

5 Connecting the 914

This chapter comprises the following sections:

- Connecting the **914** (see [Section 5.1](#))
- Connecting the remote controls (see [Section 5.2](#))
- Connecting the speakers (see [Section 5.3](#))

5.1 Connecting the 914



Always switch off the power to each device before connecting it to your **914**. After connecting your **914**, connect its power and then switch on the power to each device.

To connect the **914** as illustrated in the example in [Figure 3](#):

1. Connect the balanced, stereo audio source (for example, a multimedia player) to the INPUT 5-pin terminal block (see [Section 5.4](#)).
2. Connect the Speaker Out terminal block to a pair of speakers. Connect the left speaker to the L+ and L– pins, and the right speaker to the R– and R+ pins (in stereo mode). For bridged mono mode, see [Section 5.3](#).
Note: Do not ground the speakers.
3. Optional—Connect the GND, LEVEL and V+ pins on the 10V CONTROL terminal block connector to a remote 10k Ω volume control.
4. Optional—Connect the Standby and Mute pins to remote control switches (see [Section 5.2](#)).
5. Connect the supplied power cord to the **914** power socket and to the mains electricity (not shown in [Figure 3](#)).
6. Adjust the volume using the Level control on the rear panel.

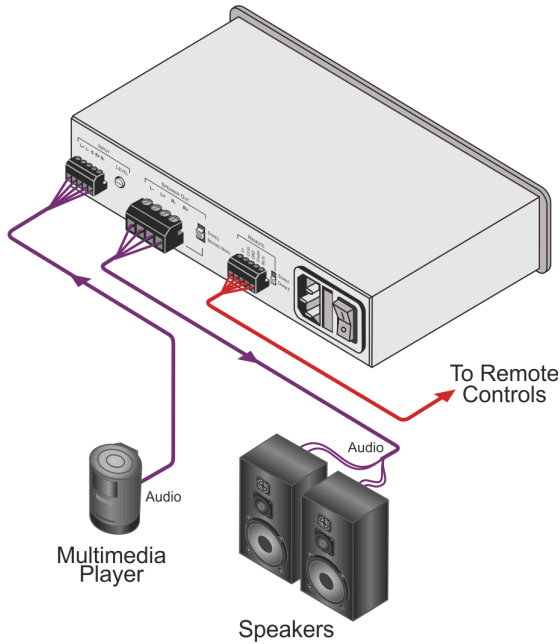

Figure 3: Connecting the 914 Power Amplifier

5.2 Connecting the Remote Controls

You can operate the **914** remotely using switches connected to the rear of the device as shown in [Figure 4](#).

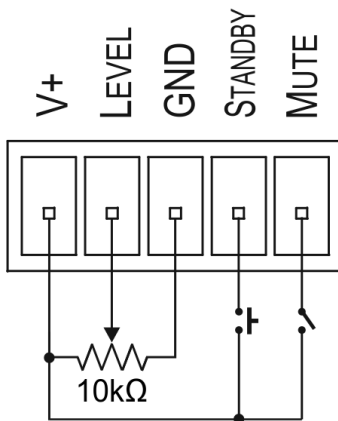

Figure 4: Connecting Remote Control Switches to the 914

To connect a remote level control, (for example, the Kramer W-LM):

- Connect one side of the potentiometer to the V+ pin
- Connect the opposite side of the potentiometer to the GND pin
- Connect the wiper of the potentiometer to the Level pin

To connect Mute and Standby switches:

- Connect one side of the Mute and Standby switches to V+
- Connect the opposite side of the Standby momentary contact switch to the STANDBY pin
- Connect the opposite side of the Mute single pole single throw switch to the MUTE pin

5.3 Connecting the Speakers

The **914** can be operated in either stereo or bridged-mono mode.

Note: When operated in stereo mode the speakers can be either 4Ω or 8Ω; when operated in bridged-mono mode the speaker can only be 8Ω.

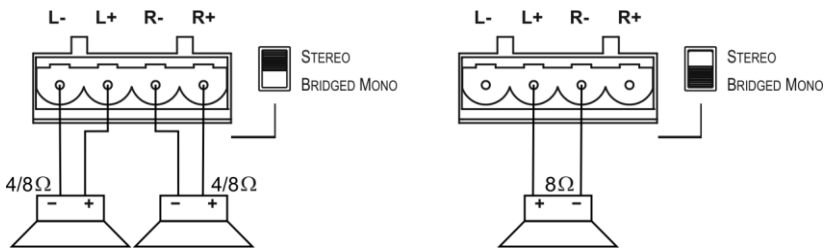

Figure 5: Connecting Speakers to the 914 Power Amplifier

To connect speakers to the 914 in stereo mode:

- Connect the L- and the L+ pins to the – and + terminals of the left speaker respectively
- Connect the R- and the R+ pins to the – and + terminals of the right speaker respectively

To connect speakers to the 914 in bridged-mono mode:

- Connect the L+ and the R- pins to the + and – terminals of the speaker respectively

5.4 Connecting a Balanced and Unbalanced Stereo Audio Input

This section illustrates how to wire:

- A balanced, stereo audio connection, see [Figure 6](#)
- An unbalanced stereo audio input connection, see [Figure 7](#)

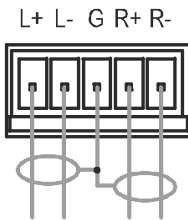

Figure 6: Balanced Stereo Audio Connection

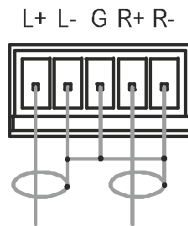

Figure 7: Unbalanced Stereo Audio Input Connection

6 Operating the 914

This chapter comprises the following sections:

- Stereo and bridged-mono modes (see [Section 6.1](#))
- Operating the **914** remotely (see [Section 6.2](#))

6.1 Stereo and Bridged Mono Modes

You can operate the **914** in either stereo or bridged mono mode. The mode is set using the switch on the rear panel of the **914**.

Note: When operated in stereo mode the speakers can be either 4Ω or 8Ω; when operated in bridged-mono mode the speaker can only be 8Ω.

To enable bridged-mono mode:

- Slide the Stereo/Bridged Mono switch on the rear panel of the **914** down

6.2 Operating the 914 Remotely

The following functions are available to operate the **914** remotely:

- Output level
- Standby
- Mute

To put the 914 into standby mode or to mute the output:

- Connect the relevant pin (Standby or Mute respectively) to the ground pin (GND) as described in [Section 5.2](#)

7 Technical Specifications

INPUT:	1 balanced stereo +4dBu/10k Ω on a 5-pin removable terminal block
OUTPUT:	1 stereo or bridged mono speaker output on a 4-pin removable large terminal block
INPUT SENSITIVITY:	0.3V (-10dBu)
OUTPUT POWER:	2 x 100W @ 4 Ω 2 x 50W @ 8 Ω 1 x 200W @ 8 Ω BTL
AMPLIFIER TYPE:	Class D
MAXIMUM VOLTAGE GAIN:	22.7dB
BANDWIDTH (-3dB):	20Hz to 20kHz
S/N RATIO:	-70dB @ 14dBu amplification
CONTROLS:	Screw trimmer for line input sensitivity; Remote 10k trimmer; Contact-closure controls for mute and standby
AUDIO THD + NOISE:	0.05% @ 75W RMS @ 4 Ω 6.67kHz
AUDIO 2nd HARMONIC:	0.08% @ 75W RMS @ 4 Ω 6.67kHz
POWER SOURCE:	See label by power socket on rear panel of unit: USA version: 100-120V AC, 50/60Hz, 360VA OR European version: 200-240V AC, 50/60Hz, 420VA
DIMENSIONS:	21.2cm x 22.8cm x 4.3cm (8.35" x 8.98" x 1.69") W, D, H
WEIGHT:	1.0kg (2.2lbs) approx.
INCLUDED ACCESSORIES:	Power cord, mounting bracket
OPTIONS:	RK-3T 19" rack adapter
Specifications are subject to change without notice at http://www.kramerelectronics.com	

LIMITED WARRANTY

The warranty obligations of Kramer Electronics for this product are limited to the terms set forth below:

What is Covered

This limited warranty covers defects in materials and workmanship in this product.

What is Not Covered

This limited warranty does not cover any damage, deterioration or malfunction resulting from any alteration, modification, improper or unreasonable use or maintenance, misuse, abuse, accident, neglect, exposure to excess moisture, fire, improper packing and shipping (such claims must be presented to the carrier), lightning, power surges, or other acts of nature. This limited warranty does not cover any damage, deterioration or malfunction resulting from the installation or removal of this product from any installation, any unauthorized tampering with this product, any repairs attempted by anyone unauthorized by Kramer Electronics to make such repairs, or any other cause which does not relate directly to a defect in materials and/or workmanship of this product. This limited warranty does not cover cartons, equipment enclosures, cables or accessories used in conjunction with this product.

Without limiting any other exclusion herein, Kramer Electronics does not warrant that the product covered hereby, including, without limitation, the technology and/or integrated circuit(s) included in the product, will not become obsolete or that such items are or will remain compatible with any other product or technology with which the product may be used.

How Long Does this Coverage Last

Seven years as of this printing; please check our Web site for the most current and accurate warranty information.

Who is Covered

Only the original purchaser of this product is covered under this limited warranty. This limited warranty is not transferable to subsequent purchasers or owners of this product.

What Kramer Electronics will do

Kramer Electronics will, at its sole option, provide one of the following three remedies to whatever extent it shall deem necessary to satisfy a proper claim under this limited warranty:

1. Elect to repair or facilitate the repair of any defective parts within a reasonable period of time, free of any charge for the necessary parts and labor to complete the repair and restore this product to its proper operating condition. Kramer Electronics will also pay the shipping costs necessary to return this product once the repair is complete.
2. Replace this product with a direct replacement or with a similar product deemed by Kramer Electronics to perform substantially the same function as the original product.
3. Issue a refund of the original purchase price less depreciation to be determined based on the age of the product at the time remedy is sought under this limited warranty.

What Kramer Electronics will not do Under This Limited Warranty

If this product is returned to Kramer Electronics or the authorized dealer from which it was purchased or any other party authorized to repair Kramer Electronics products, this product must be insured during shipment, with the insurance and shipping charges prepaid by you. If this product is returned uninsured, you assume all risks of loss or damage during shipment. Kramer Electronics will not be responsible for any costs related to the removal or re-installation of this product from or into any installation. Kramer Electronics will not be responsible for any costs related to any setting up this product, any adjustment of user controls or any programming required for a specific installation of this product.

How to Obtain a Remedy under this Limited Warranty

To obtain a remedy under this limited warranty, you must contact either the authorized Kramer Electronics reseller from whom you purchased this product or the Kramer Electronics office nearest you. For a list of authorized Kramer Electronics resellers and/or Kramer Electronics authorized service providers, please visit our web site at www.kramerelectronics.com or contact the Kramer Electronics office nearest you.

In order to pursue any remedy under this limited warranty, you must possess an original, dated receipt as proof of purchase from an authorized Kramer Electronics reseller. If this product is returned under this limited warranty, a return authorization number, obtained from Kramer Electronics, will be required. You may also be directed to an authorized reseller or a person authorized by Kramer Electronics to repair the product.

If it is decided that this product should be returned directly to Kramer Electronics, this product should be properly packed, preferably in the original carton, for shipping. Cartons not bearing a return authorization number will be refused.

Limitation on Liability

THE MAXIMUM LIABILITY OF KRAMER ELECTRONICS UNDER THIS LIMITED WARRANTY SHALL NOT EXCEED THE ACTUAL PURCHASE PRICE PAID FOR THE PRODUCT. TO THE MAXIMUM EXTENT PERMITTED BY LAW, KRAMER ELECTRONICS IS NOT RESPONSIBLE FOR DIRECT, SPECIAL, INCIDENTAL OR CONSEQUENTIAL DAMAGES RESULTING FROM ANY BREACH OF WARRANTY OR CONDITION, OR UNDER ANY OTHER LEGAL THEORY. Some countries, districts or states do not allow the exclusion or limitation of relief, special, incidental, consequential or indirect damages, or the limitation of liability to specified amounts, so the above limitations or exclusions may not apply to you.

Exclusive Remedy

TO THE MAXIMUM EXTENT PERMITTED BY LAW, THIS LIMITED WARRANTY AND THE REMEDIES SET FORTH ABOVE ARE EXCLUSIVE AND IN LIEU OF ALL OTHER WARRANTIES, REMEDIES AND CONDITIONS, WHETHER ORAL OR WRITTEN, EXPRESS OR IMPLIED. TO THE MAXIMUM EXTENT PERMITTED BY LAW, KRAMER ELECTRONICS SPECIFICALLY DISCLAIMS ANY AND ALL IMPLIED WARRANTIES, INCLUDING, WITHOUT LIMITATION, WARRANTIES OF MERCHANTABILITY AND FITNESS FOR A PARTICULAR PURPOSE. IF KRAMER ELECTRONICS CANNOT LAWFULLY DISCLAIM OR EXCLUDE IMPLIED WARRANTIES UNDER APPLICABLE LAW, THEN ALL IMPLIED WARRANTIES COVERING THIS PRODUCT, INCLUDING WARRANTIES OF MERCHANTABILITY AND FITNESS FOR A PARTICULAR PURPOSE, SHALL APPLY TO THIS PRODUCT AS PROVIDED UNDER APPLICABLE LAW.

IF ANY PRODUCT TO WHICH THIS LIMITED WARRANTY APPLIES IS A "CONSUMER PRODUCT" UNDER THE MAGNUSON-MOSS WARRANTY ACT (15 U.S.C.A. §2301, ET SEQ.) OR OTHER APPLICABLE LAW, THE FOREGOING DISCLAIMER OF IMPLIED WARRANTIES SHALL NOT APPLY TO YOU, AND ALL IMPLIED WARRANTIES ON THIS PRODUCT, INCLUDING WARRANTIES OF MERCHANTABILITY AND FITNESS FOR THE PARTICULAR PURPOSE, SHALL APPLY AS PROVIDED UNDER APPLICABLE LAW.

Other Conditions

This limited warranty gives you specific legal rights, and you may have other rights which vary from country to country or state to state.

This limited warranty is void if (i) the label bearing the serial number of this product has been removed or defaced, (ii) the product is not distributed by Kramer Electronics or (iii) this product is not purchased from an authorized Kramer Electronics reseller. If you are unsure whether a reseller is an authorized Kramer Electronics reseller, please visit our Web site at www.kramerelectronics.com or contact a Kramer Electronics office from the list at the end of this document.

Your rights under this limited warranty are not diminished if you do not complete and return the product registration form or complete and submit the online product registration form. Kramer Electronics thanks you for purchasing a Kramer Electronics product. We hope it will give you years of satisfaction.



For the latest information on our products and a list of Kramer distributors, visit our Web site where updates to this user manual may be found.

We welcome your questions, comments, and feedback.

Web site: www.kramerelectronics.com

E-mail: info@kramere1.com

CE



SAFETY WARNING

Disconnect the unit from the power supply before opening and servicing



P/N: 2900-300280



Rev: 1