

VIORE™ TECHNOLOGY & INNOVATION

OPERATING INSTRUCTIONS

7" Portable ATSC Digital TV **PLC7V95**

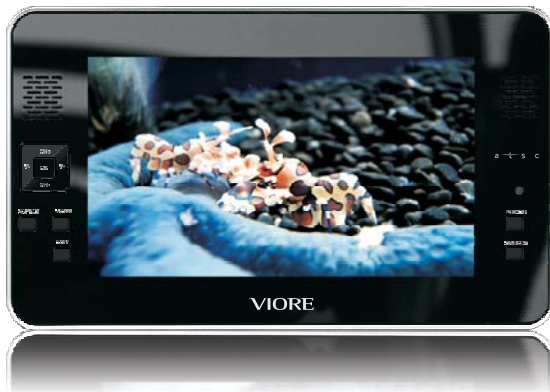

Table of Contents

Table of Contents	1
Safety Precautions	2
Important Safety Instructions	3
Introduction	5
Safety Information	6
Remote Control	7
Front and Rear panel illustration	9
Getting Started	10-11
PICTURE Menu	12
AUDIO Menu	12
TIMER Menu	13
SETUP Menu	13
V-CHIP Menu	14-18
CHANNEL Menu	19
Service & Support	20
Specifications	20

Safety Precautions

Introduction



THE LIGHTNING FLASH WITH ARROWHEAD SYMBOL WITHIN AN EQUILATERAL TRIANGLE IS INTENDED TO ALERT THE USER TO THE PRESENCE OF UNINSULATED "DANGEROUS VOLTAGE" WITHIN THE UNIT'S CABINET THAT MAY BE OF SUFFICIENT MAGNITUDE TO CONSTITUTE A RISK OF ELECTRIC SHOCK TO PERSONS. THE EXCLAMATION POINT WITHIN AN EQUILATERAL TRIANGLE IS INTENDED TO ALERT THE USER TO THE PRESENCE OF IMPORTANT OPERATING AND MAINTENANCE (SERVICING) INSTRUCTIONS IN THE MANUAL ACCOMPANYING THE UNIT.



WARNING:

TO PREVENT FIRE OR ELECTRIC SHOCK, DO NOT EXPOSE THE UNIT TO RAIN OR MOISTURE. NEVER ATTEMPT TO OPEN THE CABINET. DANGEROUS HIGH VOLTAGES ARE PRESENTED IN THE UNIT. REFER SERVICING TO QUALIFIED SERVICE PERSONNEL.

CAUTION:

TO PREVENT ELECTRIC SHOCK, MATCH WIDE-BLADE PLUG WITH WIDE SLOT AND FULLY INSERT. THE APPARATUS SHALL NOT BE EXPOSED TO WATER AND NO OBJECTS FILLED WITH LIQUID SUCH AS VASES SHALL BE PLACED ON THE APPARATUS.

WARNING:

FCC REGULATIONS STATE THAT ANY CHANGE OR MODIFICATION TO THE EQUIPMENT, NOT EXPRESSLY APPROVED BY MAKER OR ITS AUTHORIZED PARTIES, COULD VOID USER'S AUTHORITY TO OPERATE THIS EQUIPMENT.

WARNING:

THE MAINS PLUG/APPLIANCE COUPLER IS USED AS THE DISCONNECT DEVICE. THE DISCONNECT DEVICE SHALL REMAIN READILY OPERABLE. ALWAYS REMEMBER TO REMOVE THE PLUG FROM THE MAINS SOCKET BEFORE DISCONNECTING THE POWER LEAS FROM THE UNIT. THE APPARATUS SHALL NOT BE EXPOSED TO DRIPPING OR SPLASHING AND THAT NO OBJECTS FILLED WITH LIQUIDS, SUCH AS VASES, SHALL BE PLACED ON THE APPARATUS. NO NAKED FLAME SOURCES SUCH AS LIGHTED CANDLES SHOULD BE PLACED ON THE APPARATUS. THE USE OF APPARATUS IN MODERATE CLIMATES

WARNING:

ATTENTION SHOULD BE DRAWN TO THE ENVIRONMENTAL ASPECTS OF BATTERY DISPOSAL. DANGER OF EXPLOSION IF BATTERY IS INCORRECTLY REPLACED. REPLACE ONLY WITH THE SAME OR EQUIVALENT TYPE.

Important Safety Instructions

Introduction

1. Read Instructions

All the safety and operating instructions should be read before the product is operated.

2. Retain Instructions

The safety and operating instructions should be retained for future reference.

3. Heed Warnings

All warnings on the product and in the operating instructions should be adhered to.

4. Follow Instructions

All operating instructions should be followed.

5. Cleaning

Unplug this product from the wall outlet before cleaning. Do not use liquid cleaners or aerosol cleaners. Use a damp cloth for cleaning.

6. Attachments

Do not use attachments not recommended by the product manufacturer as they may cause hazards.

7. Water and Moisture

Do not use this product near water for example, near a bathtub, wash bowl, kitchen sink, or laundry tub; in a wet basement; or near a swimming pool; and the like.

8. Accessories

Do not place this product on an unstable cart, stand, tripod, bracket, or table. The product may fall, causing serious injury to a child or adult, and serious damage to the product. Use only with a cart, stand, tripod, bracket, or table recommended by the manufacturer, or sold with the product. Any mounting of the product should follow the manufacturer's instructions, and should use a mounting accessory recommended by the manufacturer.

9. Portable Cart Warning

A product and cart combination should be moved with care. Quick stop, excessive force, and uneven surface may cause the product and cart combination to overturn.



(Symbol provided by RETAC)

10. Ventilation

Slots and openings in the cabinet are provided for ventilation and to ensure reliable operation of the product and to protect it from overheating, and these openings must not be blocked or covered. The openings should never be blocked by placing the product on a bed, sofa, rug, or other similar surface. This product should not be placed in a built-in installation such as a bookcase or rack unless proper ventilation is provided or the manufacturer's instructions have been adhered to.

11. Power Sources

This product should be operated only from the type of power source indicated on the marking label. If you are not sure of the type of power supply to your home, consult your product dealer or local power company. For products intended to operate from battery power or other sources, refer to the operating instructions.

12. Grounding or Polarization

This product may be equipped with a polarized alternating current line plug (a plug having one blade wider than the other). This plug will fit into the power outlet only one way. This is a safety feature. If you are unable to insert the plug fully into the outlet, try reversing the plug. If the plug should still fail to fit, contact your electrician to replace your obsolete outlet. Do not defeat the safety purpose of the polarized plug.

13. Power Cord Protection

Power supply cords should be routed so that they are not likely to be walked on or pinched by items placed upon or against them, paying particular attention to cords at plugs, convenience receptacles, and the point where they exit from the product.

Important Safety Instructions

Introduction

14. Outdoor Antenna Grounding

If an outside antenna or cable system is connected to the product, be sure the antenna or cable system is grounded so as to provide some protection against voltage surges and built-up static charges. Article 810 of the National Electrical Code, ANSI/NFPA 70, provides information with regard to proper grounding of the mast and supporting structure, grounding of the lead-in wire to an antenna discharge unit, size of grounding conductors, location of antenna discharge unit, connection to grounding electrodes, and requirements for the grounding electrode. See figure below.

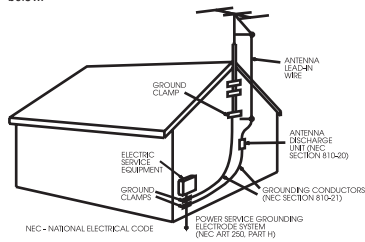

15. Lightning

For added protection for this product during a lightning storm, or when it is left unattended and unused for long periods of time, unplug it from the wall outlet and disconnect the antenna or cable system. This will prevent damage to the product due to lightning and power lines surges.

16. Power Lines

An outside antenna system should not be located in the vicinity of overhead power lines or other electric light or power circuits, or where it can fall into such power lines or circuits. When installing an outside antenna system, extreme care should be taken to keep from touching such power lines or circuits as contact with them might be fatal.

17. Overloading

Do not overload wall outlets, extension cords, or integral convenience receptacles, as this can result in a risk of fire or electric shock.

18. Object and Liquid Entry

Never push objects of any kind into this product through openings as they may touch dangerous voltage points or short-out parts that could result in a fire or electric shock. Never spill liquid of any kind on the product.

19. Servicing

Do not attempt to service this product yourself as opening or removing covers may expose you to dangerous voltage or other hazards. Refer all servicing to qualified service personnel.

20. Damage Requiring Service

Unplug this product from the wall outlet and refer servicing to qualified service personnel under the following conditions:

- A) When the power-supply cord or plug is damaged,
- B) If liquid has been spilled, or objects have fallen into the product,
- C) If the product has been exposed to rain or water,
- D) If the product does not operate normally by following the operating instructions. Adjust only those controls that are covered by the operating instructions as an improper adjustment of other controls may result in damage and will often require extensive work by a qualified technician to restore the product to its normal operation,
- E) If the product has been dropped or damaged in any way,
- F) When the product exhibits a distinct change in performance this indicates a need for service.

21. Replacement Parts

When replacement parts are required, be sure the service technician has used replacement parts specified by the manufacturer or have the same characteristics as the original part. Unauthorized substitutions may result in fire, electric shock, or other hazards.

22. Safety Check

Upon completion of any service or repairs to this product, ask the service technician to perform safety checks to determine that the product is in proper operating condition.

23. Wall or Ceiling Mounting

The product should be mounted to a wall or ceiling only as recommended by the manufacturer.

24. Heat

The product should be situated away from heat sources such as radiators, heat registers, stoves, or other products (including amplifiers) that produce heat.

Introduction

Safety Information

Thank you for purchasing this product which has been designed and manufactured to give you many years of trouble-free service.

About This User Guide

This user guide contains all the information you need to know about how to setup and watch available free view channels using your Portable ATSC TV.

Accessories In the Box

Remove your Portable ATSC TV carefully from the box , and remove the packaging from each part.

You will find the following items:

- Portable ATSC TV
- Remote Control (CR2025 battery included)
- User Manual
- USB adaptor
- Magnetic base antenna
- Power adaptor



Look out for this symbol. It indicates useful and important tips.

If the AC/DC adapter is connected while the TV is powered on, it will supply the unit with power. Note: the battery will always be recharged while the AC/DC adapter is connected.

Warning: Change or modifications to this unit not expressly by the part responsible for compliance could void the user's authority to operate the Equipment.

NOTE:

This equipment has been tested and found to comply with the limits for a Class B digital device, pursuant to Part 15 of the FCC Rules. These limits are designed to provide reasonable protection against harmful interference in a residential installation. This equipment generates, uses, and can radiate radio frequency energy and, if not installed and used in accordance with the instructions, may cause harmful interference will not occur in a particular installation. If this equipment does cause harmful interference to radio or television reception, which can be determined by turning the equipment off and on, the user is encouraged to try to correct the interference by one or more of the following measures:

- Reorient or relocate the receiving antenna.
- Increase the separation between the equipment and receiver.
- Connect the equipment into an outlet on a circuit different from that to which the receiver is connected .
- Consult the dealer or an experienced radio TV technician or help.

Shield cables must be used with this unit to ensure compliance with the Class B FCC limits.

Safety Information

The apparatus shall not be exposed to dripping or splashing and that no objects filled with liquids, such as vases, shall be placed the apparatus.

The mains plug is used as the disconnect device, the disconnect device shall remain readily operable.

Always remember to remove the plug from the mains socket before disconnecting the power lead from the back of the unit.

Safety is Important



To ensure your safety and the safety of others, please ensure you read the Safety Instructions before you operate this product.
Keep this information in a safe place for future reference.
Please read all the safety information before use.

Safety Considerations

- Position the cables so that they cannot be walked on or pinched by items placed on or against them.
- Do not use the Portable ATSC TV in humid or damp conditions.
- Do not allow the Portable ATSC TV to get wet.
- Do not expose the Portable ATSC TV to dripping or splashing.
- Do not place water filled objects such as vases on top of the Portable ATSC TV.
- Do not place naked flame sources, such as candles, on top of the Portable ATSC TV.

Cleaning

- ALWAYS unplug the Portable ATSC TV before you clean it.
- Do not use liquid or aerosol cleaners.
- Clean the Portable ATSC TV with a soft, damp (not wet) cloth.

Ventilation

- The slots and openings on the Portable ATSC TV are for ventilation.
- Do not cover or block them as it may cause overheating.
- NEVER let children push anything into the holes or slots on the case.

Servicing

- There are no user serviceable parts in this Portable ATSC TV.
- When servicing, refer to qualified service personnel.
- Consult your dealer if you are ever in doubt about the installation, operation or safety of this unit.

Battery Disposal

- Please ensure batteries are disposed of safely.
- Never dispose of batteries in the fire or with household waste.
- Check with your local authority for disposal regulations.

Remote Control

Remote Key Function:

- 1) **POWER:** To set the TV standby or power on.
- 2) **P.M.:** To switch picture mode.
- 3) **NUMBER KEYS:**
For directly access the program.
- 4) **RECALL:**
To access the previously viewed program.
- 5) **MENU:**
To display TV menu or to return to the previous menu.
- 6) **EXIT:** Used to exit menu.
- 7) **TV DISPLAY:**
Display/removes the program information.
- 8) **VOL +:** To increase sound level.
- 9) **VOL -:** To decrease sound level.
- 10) **EPG:**
Display/removes all the information of DTV programs.
- 11) **FAV:**
Used to access your favourite programs.
- 12) **MUTE:** To disable or enable the sound.
- 13) **S.M.:** To switch sound mode.
- 14) **SLEEP:** Set time to turn off the TV.
- 15) **ASPECT:**
To change picture aspect.
- 16) **AUDIO:**
To switch DTV audio channel.
- 17) **SOURCE:**
To display or exit TV input source menu.
- 18) **CURSOR:** To move within the menu.
- 19) **OK:** Confirm selection.
- 20) **CH-:**
To access the previous program.
- 21) **CH +:**
To access the next program.
- 22) **P.G.:**
Setting the Parental Control level control.
- 23) **CH.LIST:**
Used to display the channel list.
- 24) **CC:**
Enable or disable the CC function.
- 25) **Reserved key.**
- 26) **PAGE DOWN/PAGE UP:**
In EPG mode, use this key to page up/down the EPG information.

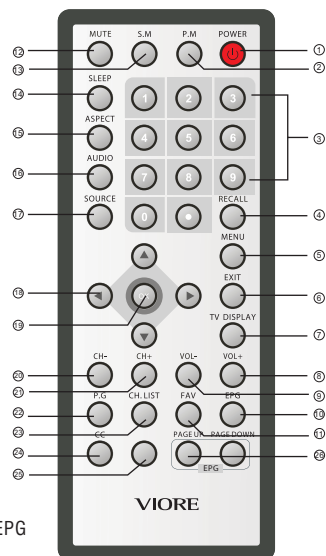

Using the Remote Control

Point the remote control at the remote sensor in order for the player to function correctly. The remote will function to approximately 21' from the remote sensor at an angle of approximately 30° each direction.

Note: Directing the remote sensor toward any light source, such as direct sunlight, may cause the unit to malfunction. Do not spill water or put wet items on the remote control. Never disassemble remote control.

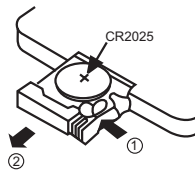

HOW TO REPLACE THE BATTERY
STEP 1: PUSH THE BUTTON TOWARD LEFT;
STEP 2: PULL THE BATTERY LOADER OUT.

Caution:

Incorrect use of batteries may cause them to leak, corrode or explode.

- ◆ Be sure to place the batteries in the correct direction.
- ◆ It is dangerous to charge/heat/open or short-circuit the batteries.
- ◆ Do not leave dead or expired batteries or mix old/new batteries.
- ◆ When not using the remote control for a long duration of time, remove the batteries.
- ◆ When operating range becomes reduced, replace all batteries with new, fresh ones.
- ◆ If leakage from the battery occurs, wipe the battery liquid from the battery compartment, then replace.

Built-in Rechargeable Battery Management

The capacity of built-in rechargeable Lithium Polymer battery is 1800mAh, which can provide about 1.5 hours of operation depending on the usage conditions. This portable TV uses a smart battery management system inside which can support low battery detection.

1. If the battery voltage falls below a specific value, the unit will enter low battery mode, displaying a flashing low battery icon in the OSD, indicating the user needs to recharge the TV immediately.
2. If the AC/DC adapter is connected while the TV is powered on, it will supply the unit with power. Note: the battery will always be recharged while the AC/DC adapter is connected.
3. If the TV is kept running on low battery without using AC/DC adapter, the TV will shut down after a short time to protect the battery from depletion..

Front and Rear panel illustration

1. Front View

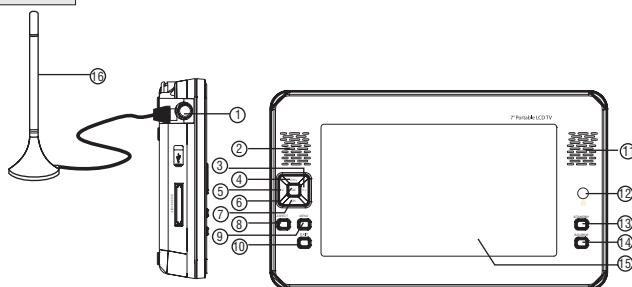

- 1) **Antenna input:** Connect to an external RF signal.
- 2) **Speaker Left:** The left speaker.
- 3) **VOL +:** Move around the menu screens or changing the volume in non-menu state.
- 4) **CH +:** Move around the menu screens or selecting the channels in non-menu state.
- 5) **VOL -:** Move around the menu screens or changing the volume in non-menu state.
- 6) **OK:** Confirm a selection within a menu.
- 7) **CH -:** Move around the menu screens or selecting the channels in non-menu state.
- 8) **ASPECT:** To change picture aspect.
- 9) **MENU:** Open the main menu window.
- 10) **EXIT:** Exit menu.
- 11) **Speaker Right:** The right speaker.
- 12) **REMOTE CONTROL SENSOR:** Receive the signal from the remote control
- 13) **STANDBY:** To set the portable TV to standby.
- 14) **SOURCE:** To select input source.
- 15) **TFT screen:** Display the TFT widescreen display.
- 16) **External rod Antenna**

2. Right View

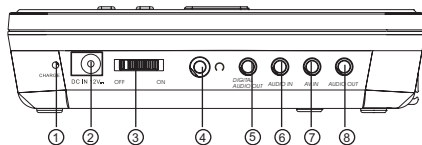

- 1) **CHARGE INDICATOR:** The system is in charging state when red LED is lighting, it will turn into green when full charged.
- 2) **DC IN JACK:** This is used for AC-DC adaptor input, the voltage range is 12V.
- 3) **POWER SWITCH:** This switch used to switch on/off the system, the system will enter fast charging state if the DC adaptor connected in power off state.
- 4) **EARPHONE JACK:** This jack outputs analog audio L/R signal to earphone.
- 5) **DIGITAL AUDIO OUT:** This jack outputs analog coaxial audio signal.
- 6) **AUDIO IN JACK:** This jack is used for input analog audio L/R signal to system.
- 7) **AV IN JACK:** This jack is used for input composite video signal to system.
- 8) **AUDIO OUT JACK:** This jack out puts analog audio L/R signal.

Getting Started

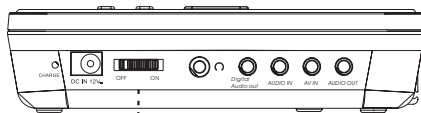

Switch the button to ON position to power on the system

Switching on for the First Time

1. Connect the rod antenna to antenna jack on the left side of the unit.
2. Connect the power adaptor to "DC IN 12V" jack on the right side of the unit
3. Switch on the portable LCD TV using the power key on the right side of the unit.
4. Press MENU key and select the rightmost icon-channel menu.



5. Use the navigation key to select the TV source item and select Air or CATV.
6. Select the Auto Scan item and press the Right key to start auto searching all the channel programs.



7. After completing the Auto Scan, use the channel +/- key or numeric keys (remote control only) to select the TV programs.

Getting Started



- For good reception, place the rod antenna as near as the window of house, and place it as far as the screen of this ATSC receiver.
- Don't place the rod antenna near other machine/appliance (such as motor, computer, switching power, TV, audio power amplifier, speakers... etc), since these machines/appliances can cause interferences to the antenna.



- To conserve power while the TV is not in use, the power switch key on the right side should be turned to the OFF position.

How to use USB interface

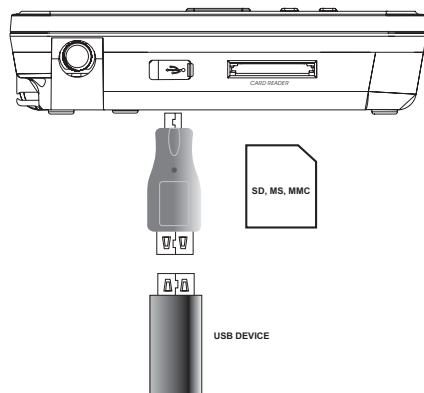

1. Connect USB storage with the USB adapter.
2. Connect USB adapter with the portable LCD TV by the mini USB interface.
3. Press the source key and select the External Storage item.
4. Select the USB icon.
5. Then can select JPG icon or MUSIC icon or MOVIE icon to play the JPG file or Mp3 file or MOVIE file.

How to use 3 In 1 Card Reader

1. Insert SD or MS or MMS card into the Card Reader interface.
2. Press the source key and select the External Storage item.
3. Select the SD/MS/MMC icon.
4. Then select JPG icon or MUSIC icon or MOVIE icon to play the JPG file or Mp3 file or MOVIE file.

Please refer to page 19 for details of USB and card reader use.

1. PICTURE MENU

The first item of the MENU is PICTURE MENU.
You can adjust picture effect here, such as contrast, brightness, etc.
Press ▼▲ to select, press ◀▶ to adjust, press MENU to exit.



Note:
If you want to adjust contrast, brightness, color and sharpness, the picture mode must return to "personal" status.

2.AUDIO MENU

The second item of the MENU is AUDIO MENU. You can adjust sound here.
Press ▼▲ to select, press ◀▶ to adjust, press MENU to exit.

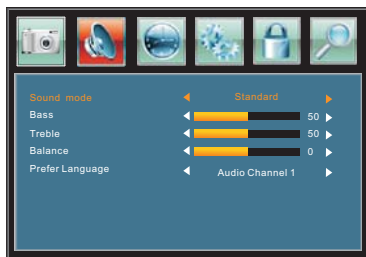

3. TIMER MENU

The third item of the MENU is TIMER MENU. You can adjust time here.
Press ▼▲ to select, press ◀▶ to adjust, press MENU to exit.



1). SLEEP TIMER: adjust this item , you can set the sleep timer .

4. SETUP MENU

1). The fourth item of the MENU is SETUP MENU. You can setup system here.
Press ▼▲ to select, press ◀▶ to adjust, press MENU to exit.



Note:

Restore Default: Reset all the settings to default value.

Software Upgrade: Only use for system software upgrade by USB .

2). Closed Caption: switch close caption mode.

Press ▼▲ button to select Closed Caption ,Press ► button, the screen will display as follow:

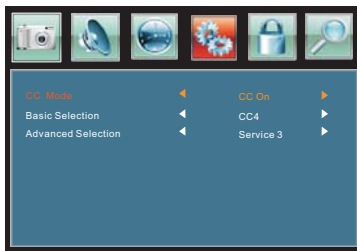

5. V-CHIP MENU

The fifth item of the MENU is V-CHIP MENU. You can setup Parental Control here.

Press ▼▲ to select, press ◀▶ to adjust, press MENU to exit.

Parent control: input the password, it will go into Parental Control menu. Factory default password is 6666.

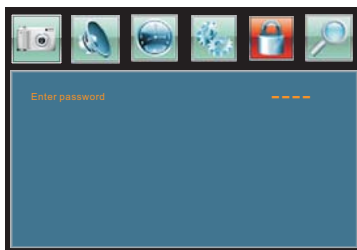

5.1 .Input the correct password ,the screen will display as follow:

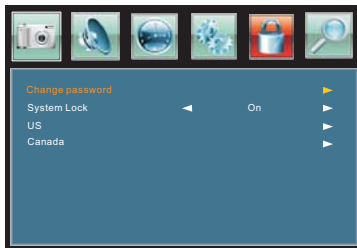

1). Change Password: Press ► button, the screen will display as follow:

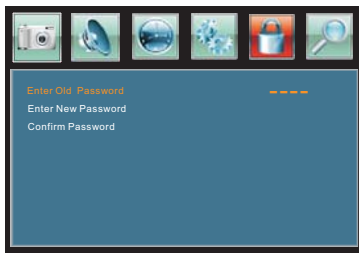

- 1).Enter Old Password: Input the old password.
- 2).Enter New password: Input the new password.
- 3).Confirm password: Input the new password again.

5.2 V-CHIP switch:

When the System Lock is ON, the below options can be adjusted.

5.3 US: Press ► button, the screen will display as follow:

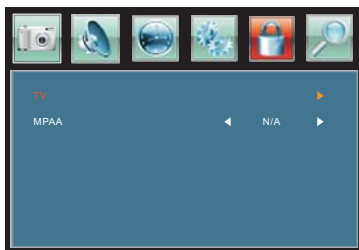

1):TV: Press ► button, the screen will display as follow:





Rating	Content	Content				
		FV(Fantasy violence)	V (Violence)	S(Sexual situation)	L (Adult language)	D (Sexually suggestive dialog)
Suggested age	TV-Y (All children)					
	TV-Y7(Direct to order children)	X				
	TV-G(General audience)					
	TV-PG(Parental Guidance suggested)		X	X	X	
	TV-14(Parents strongly cautioned)		X	X	X	X
	TV-MA(Mature audience only)		X	X	X	X

And use OK key to switch lock/ unlock Parental Control feature.

2).MPAA:switch the movie-rating control level; N/A, G,PG, PG-13,R,NC-17,X.

Rating	Description
G	General audiences, All Ages admitted
PG	Parental Guidance suggested. Some material may not be suitable for children.
PG-13	Parents strongly cautioned. Some material .may be inappropriate for children under 13.
R	Restrict. Under 17 requires accompanying parent or adult guardian(age varies in some jurisdictions)
NC-17	No one 17 and under admitted.
X	X is an order rating that is unified with NC-17 but may be encoded in the data of order movies.

5.4 Canada: Press ► button, the screen will be displayed as follow:

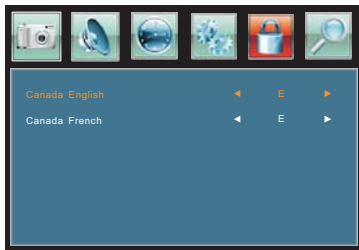

1) Canadian English: switch the english rating control level: E, C, C8+, G, PG, 14+, 18+.

Rating	Description
E	Exempt: Includes news, sports, documents and other information programming: talk shows, music videos, and variety programming.
C	Children: Intended for younger children under the age of 8 years. Pays careful attention to themes that could threaten their sense of security and well-being.
C8+	Children over 8 years old: Contains no portrayal of violence as the preferred, acceptable, or only way to resolve conflict; nor encourage children to imitate dangerous acts which they may see on the screen.
G	General: Considered acceptable for all age groups, Appropriate viewing for the entire family, contains very little violence, physical, verbal or emotional.
PG	Parental Guidance: Intended for a general audience, but may not be suitable for younger children (under the age of 8) because it could contain controversial themes or issues.
14+	Over 14 Years: Could contain themes where violence is one of the dominant elements of the storyline But it must be integral to the development of plot or character. Language usage could be profane and nudity, present within the context of theme.
18+	Adults: Intended for viewers 18 years and older and might contain depictions of violence, which while related to the development of plot, character or themes, are intended for adult viewing. Could contain graphic language and portrayals of secretary and nudity.

2) Canadian French: switch the French-rating control level: E, G, 8ANS+, 13 ANS+, 16ANS+, 18ANS+.

Rating	Description
E	Exempt programming
G	General :All ages and children, contains minimal direct violence, but may be integrated into the plot in a humorous or unrealistic manner.
8ans+	General but inadvisable for young children :May be viewed by a wide public audience, but could contain scenes disturbing to children under 8 who cannot distinguish between imaginary and real situations. Recommended for viewing with paren.
13ans+	Over 13 years: Could contain scenes of frequent violent scenes and in tense violence.
16ans+	Over 16 years: Could contain frequent violent scenes and violence.
18ans+	Over 18 years: Only for adult viewing. Could contain frequent violent scenes and extreme violence.

6. Channel MENU

The rightmost icon is Channel MENU. You can adjust digital TV Channel .
Press ▼▲ to move, press ◀▶ to adjust here.



- 1). TV Source: select Air TV signal or cable TV signal.
- 2). Auto Scan: press the ▶ button to confirm, you will see below menu :



- 3). Favorite: Press ◀▶ button to choose/delete the favorite channel .
- 4). Show/Hide: Press ◀▶ button to display or hide currently channel.
- 5). Channel NO. :Display the currently channel number.
- 6). Channel lable: Press ▲▼ button to edit currently channel name.
- 7). DTV signal: Display DTV signal intension. It can't be selected and adjusted.

External Storage MENU

Please use the CURSOR key and OK key to operation.

1. Top Menu

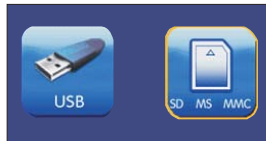

2. Navigation Menu



3. Select Menu



4. Play Menu

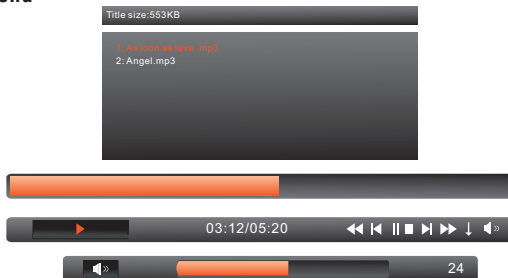

Play Control Bar:

- | | | | |
|------------------|-----------------|----------------|---|
| ◀◀ Fast backward | ▶▶ Fast Forward | 🔊 Volume level | 📺 Six window navigation (only for JPG file) |
| ◀ Previous | ▶ Next | 🔄 Repeat all | T JPG play interval time |
| ▶/ Play/Pause | ↓ Normal play | 🔄 Repeat one | 🔍 ZOOM(only for JPG file) |
| ■ Stop | ↻ Shuffle play | | |

To use the button on front panel to adjust volume, please select the Play Control Bar and select 🔊 icon and press OK key, then press V +/- key for volume control.

Service & Support

Problem	Probable cause	What to do
No signal found	Aerial is disconnected Aerial is damaged/misaligned Out of digital signal area	Check aerial lead Check aerial Check with dealer
No picture or sound	Under standby mode	Press the POWER button
Encrypted channel message	It is a pay per view channel	Select an alternative channel
No response from remote control	Remote control is not aimed correctly Front panel obstructed Remote control batteries inserted incorrectly Remote control batteries exhausted	Aim remote control at front panel Check for obstructions Check batteries are inserted correctly Replace remote control batteries
Square blocks in picture or picture freezes	Aerial may not be compatible Aerial is damaged/misaligned	Check with dealer Check aerial

Specifications

Video Signal System	ATSC
Display Device	Color TFT-LCD
Receiving Channel	Air: 2-69 Cable: 2-135
Screen Size	7 inches
Screen pixels	1440x234 dot
Audio output	2CH
Power Voltage	DC IN 12V
Power consumption	≤15W
Size	220X130X31mm
Weight	0.65kg

Specifications are subject to change without notice.