

Palsonic

The AUSTRALIAN Company

User's Manual

TFTV804LED

80cm (31.5") HD LED TV with DVB-T



*Where available

Offering Australians quality since 1958 | www.palsonic.com.au



Important safety information



Grounding information

This apparatus must be grounded. To ensure safe operation, the grounded plug must be inserted only into a standard grounded power outlet which is effectively grounded through normal household wiring. Extension cords used with the equipment must be hazardous. The fact that the equipment operates satisfactorily only means it is grounded, but the installation may not necessarily be safe. For your safety, if in any doubt about the effective grounding of the equipment or power outlet, please consult a qualified technician.

WARNING: TO REDUCE THE RISK OF FIRE OR ELECTRIC, DO NOT EXPOSE THIS APPLIANCE TO RAIN OR MOISTURE. TO AVOID ELECTRIC SHOCK, INSERT TPLUG FULLY INTO THE POWER OUTLET.

Product disposal

Do not dispose of the TV with general household waste. The LED screen contains a small amount of liquid crystal and mercury. For disposal or recycling information, please contact your local authorities.

Safety precautions

Please read all of these instructions before you operate your television and save these instructions for later use. This unit has been engineered and manufactured to ensure your personal safety. However, improper use can result in electric shock or fire hazards. In order not to defeat the safeguards incorporated in this equipment, please observe the following basic rules for its installation, use and servicing.

- Unplug this television equipment from the wall outlet before cleaning.
- Do not use liquid cleaners or aerosol cleaners. Use a soft cloth moistened with water for cleaning.
- Use only the attachments recommended by the television equipment manufacturer.
- Do not use this television equipment near water—for example, near a bath tub, washbowl, kitchen sink or laundry tub, in a wet basement, or near a swimming pool.
- Do not place this equipment on an unstable surface, stand, or cart. The television equipment may fall, causing serious injury to a child or an adult, and seriously damage the equipment.
- When carrying the TV, hold it under the main unit. Do not carry the TV by its speakers. Both the base and the speakers could come off, causing you to drop the TV, possibly resulting in damage to the TV or causing injury.
- Television equipment and cart combination should be moved with care. Quick stops, excessive force, and uneven surfaces when moving may cause the equipment and cart combination to overturn.
- Shelf mounting should follow the manufacturer's instructions, and should use a mounting kit approved by the manufacturer.
- Slots and opening in the cabinet and the back or bottom are provided for ventilation. To ensure reliable operation of the television equipment and to protect it from overheating, these opening must not be blocked or covered. This television equipment should not be placed in an enclosed installation such as a bookcase unless proper ventilation is provided.

-
-
- The openings should never be covered with a cloth or other material, and the bottom openings should not be blocked by placing near or over a radiator or heat source.
 - This Television equipment should be operated only from type of power source indicated on the marking label. If you are not sure of the type of power supplied to your home, consult your television dealer or local power company.
 - As a safety feature ,this television equipment is equipped with a grounded power plug, If the plug does not fit in your power outlet, contact your electrician. Do not modify the plug and defeat this safety feature.
 - Do not allow anything to rest on the power cord. Do not locate this television equipment where the cord may be damaged due to lightning and power-line surges.
 - Follow all warnings and instructions marked on the television equipment.
 - If an outdoor antenna is connected to the television equipment, be sure the antenna system is grounded so as to provide some protection against voltage surges and static charges.
 - For added protection or this television equipment during a lightning storm, or when it is left unattended and unused for long periods of time, unplug it from the wall outlet and disconnect the antenna. This will prevent damage to the equipment due to lightning and power-line surges.
 - An outdoor antenna system should not be located in the vicinity of overhead power lines or other electric light or power circuits, or where it can fall into such power lines or circuits. When installing an outdoor antenna system, extreme care should be taken to keep from touching such power lines or circuits as contact with them might be fatal.
 - The mains plug or the appliance coupler is used as the disconnect device, the disconnect device shall remain readily operable. The mains plug is connected with the electrical outlet with safety ground wire.
 - Do not over load wall outlets and extension cords as this can result in fire or electric shock.
 - Never push objects of any kind into this television equipment through cabinet slots as they may touch dangerous voltage points or short-circuit internal parts. This could result in a fire or electric shock. Never spill liquid of any kind in the television equipment.
 - Do not attempt to service this television equipment yourself as opening or removing covers may expose you to dangerous voltage or other hazards. Refer all servicing to qualified service personnel.
 - Unplug this television equipment from the wall outlet and refer servicing to qualified service personnel under the following conditions:
 - When the power cord or plug is damaged or frayed.
 - If liquid has been spilled into the television equipment.
 - If the television equipment does not operate normally by following the operating instructions. Adjust only those control that are covered by the operating instruction as improper adjustment of other controls may result in damage and will often require extensive work by a qualified technician to restore the television equipment to normal operation.
 - If the television equipment has been dropped or the cabinet has been damaged.
 - When the television equipment exhibits a distinct change in performance
 - this indicates a need for service.
 - UP on completion of any service or repairs to this television equipment ,ask the service technician to perform routine safety checks to determine that the television is in safe operating condition.
 - When replacement parts are required, make sure that the service technician has used replacement parts specified by the manufacturer that have the same characteristics as the original part.
Unauthorized substitutions may result in fire, electric shock, or other hazards.
 - Note to CATV system installer: This note is to remind the CATV system installers that the cable ground shall be connected to the grounding system of the building, as close to the point of cable entry practical.
-
-

CAUTION:	IF the set is not going to be used for a long period, such as during a vacation, unplug the set from the wall outlet to economise power. (If the TV set is plugged in, a slight current still flows, even with the power button in OFF position)
-----------------	--

Handling the LED screen

- Do not leave the LED screen facing the sun as it can damage it. Take care when you place the TV by a window.
- Do not push or scratch the LED screen .Do not place a heavy object on the LED screen. This may cause the screen to lose conformity or cause LED panel malfunctions.
- If the TV is used in a cold place, a smear may appear on the screen. This is not a malfunction. The screen will return to normal as its temperature rises to a normal operating level.
- If a still picture is displayed for a long time on the TV screen, ghosting may occur for a while. The ghosting will eventually disappear.
- If the LED panel becomes warm during operation, this is normal and not a malfunction.

Handing of broken glass and liquid crystal leakage

If the LED panel is damaged, crystalline liquid leakage may occur, or scattered broken glass may result. Do not touch broken glass or crystalline liquid (which is toxic). With bare hands that have cuts, skin irritation or poisoning may result. If any crystalline liquid gets into mouth or eyes, rinse thoroughly with and consult your doctor.

IMPORTANT NOTICE

This product composes up to 6.0 million cells and a few cell defects may occur In the manufacture of the panel. Several dead pixels (allow up to 2 bright or 2 dark pixels) on the panel are deemed acceptable by the industry standards. In line with manufacturers and would not mean that the panel is faulty. Dead pixels panels with 6 pixels or more within 12 month period, Palsonic Corporation Pty Ltd. complies with industry standard and reserves the right to repair the unit and non-refundable. We hope you will understand that the product that corresponds to this standard is regarded as acceptable.

Table of Content

Overview of the LED TV.....	1
Features.....	1
Opening the packing.....	1
Product components.....	2
Side View.....	2
Rear View.....	3
Remote control.....	4
Using the OSD menus.....	6
Channel Adjustment.....	6
Picture Adjustment.....	8
Sound Adjustment.....	9
Time Adjustment.....	10
Lock Adjustment.....	11
Setup Adjustment.....	12
Media Operation.....	13
Record.....	14
Specifications.....	15
Troubleshooting.....	16

Overview of the LED TV

Congratulation on purchasing the LED Television. This product has been designed to provide you with a rich audio and video experience. This monitor enables you to watch broadcast, cable television or channels, connect VCR, VCD or DVD player to watch your favorite movies, or connect a computer to use the display as a monitor. The TV is equipped with convenient control buttons and a handy remote control to let you adjust the TV setting and customize the TV preferences through an easy-to-use on screen menu system.

Features

Enjoy the versatility of your LED TV with its wide variety of features:

- Color active matrix TFT LED TV with remote control
- Safe, sturdy construction
- Maximal resolution: 32" 1366 x 768
- Audio / Video support:
 - HDMI input
 - PC input
 - PC AUDIO input
 - YPbPr input
 - AV input
 - RF input
 - USB input
- On-Screen Display (OSD) menu system
- Built-in 2 speakers

Opening the packing

The following section describes the various components of the LED TV. Please take a few moments to familiarize yourself with the product and control panel before using it.

When you unpack this LED TV, make sure the box contains the following items:

- LED Color Television
- Remote Control (with batteries)
- User Manual
- Warranty Registration Card
- Quick Start Guide

If any of these items appears to be missing or damaged, please contact your vendor or authorised service personnel for assistance.

Product components

Front view

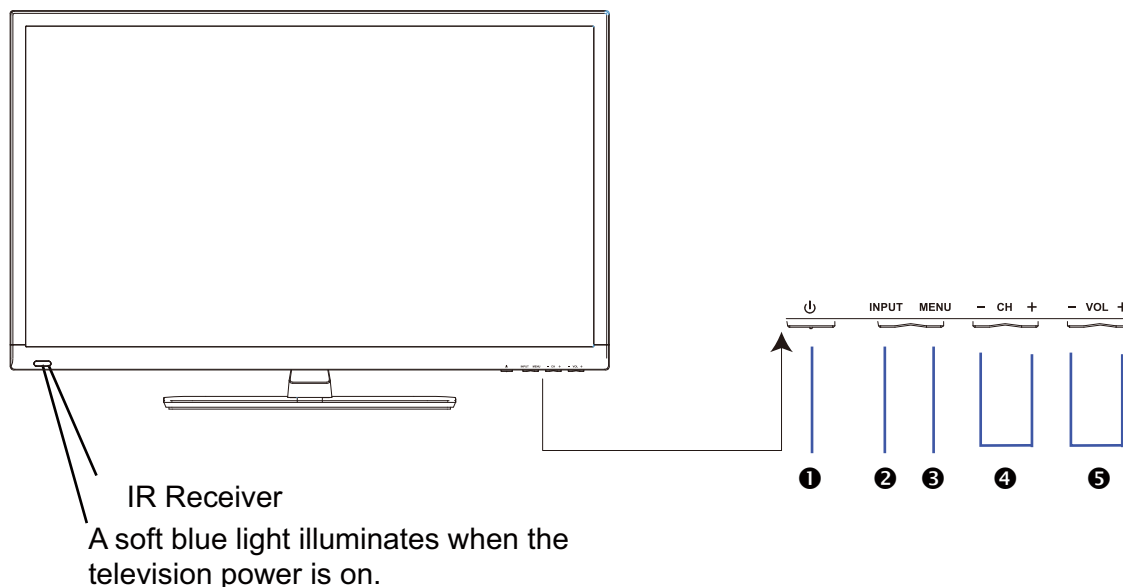

Remote Inductor and Power Indicator

❶ POWER

Turn the TV on or off.

❷ INPUT

Switch the input sources .

❸ MENU

Press the button to enter on screen Display (OSD).

❹ CH +/-

Increase or decrease channel numbers.

❺ VOL +/-

Increase or decrease the volume.

Back view

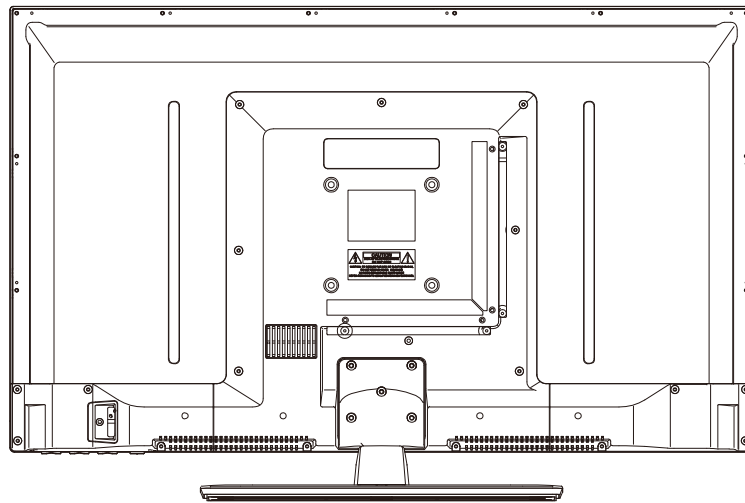

① HEADPHONE

Connect a stereo headphone (3.5mm) for private listening.

② SPDIF

Connect an optional coaxial digital cable (not included) through a compatible amp/receiver to enjoy superior audio sound.

③ AV IN

Connect to the audio and video output of A/V device.

④ HDMI 1 2 3 IN

Connect to the HDMI output of your device.

⑤ VGA

Connect to the VGA output of your device.

⑥ PC AUDIO

Connect to the audio output of your PC (earphone jack)

⑦ YPbPr

Connect to the component output of your component device.

⑧ USB

Connect to portable USB device such as USB flash / hard device.

⑨ RF IN

Connect to the UHF antenna or coaxial cable from local TV.

Remote Control

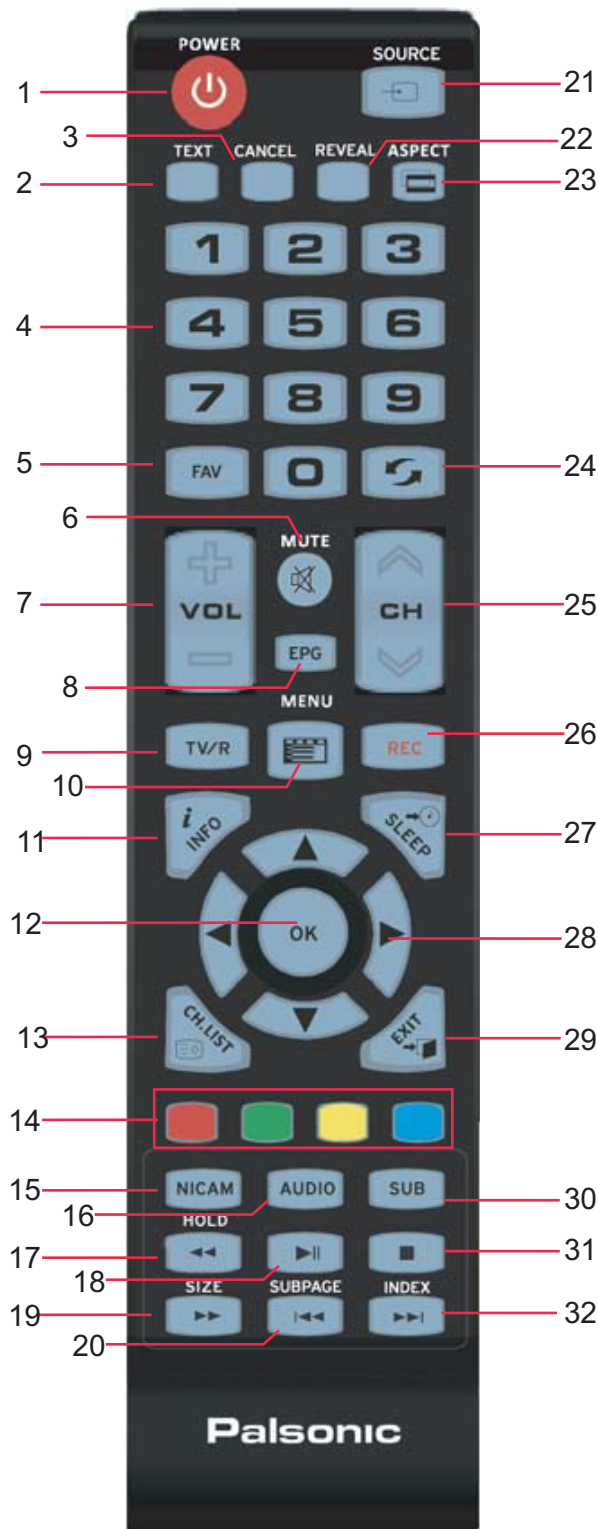

- If direct sunlight shine directly on the remote sensor, remote control's operation may be unstable, and the effective range will be shorter.
- Do not hit or violently shake the remote control.
- Never expose the remote control to high temperature or humidity.
- If the remote is not used for an extended period of time, remove the batteries to prevent damage or injury from possible battery leakage.

BUTTON	FUNCTIONS
1. POWER	Turn the TV on or off.
2. TEXT	Start the text mode.
3. CANCEL	Videotext hidden button.
4. NUMBER KEYS	Press number keys to enter channel numbers.
5. FAV	Press to display a list of favorite.
6. MUTE	Disable the audio output.
7. VOL +/-	Press +/- button to control the volume up or down.
8. EPG	Press to display electronic program guide menu.
9. TV/R	Select the TV/RADIO mode.
10.MENU	Enter or exit the OSD menu.
11.INFO	Display a variety of information about current channel.
12. OK	Make sure the adjustment setted previously.
13. CH.LIST	Display the channel list.
14. COLOUR KEYS	Different input source has different functions.
15. NICAM	Press repeatedly to cycle through the NICAM mode.
16. AUDIO	Select an audio source for the current programme.
17. ◀◀ HOLD	Press to scan in reverse. Hold freeze the current teletext page on the screen.
18. ▶▶	Press to stop the current program.
19. ▶▶ SIZE	Press to scan in forward. You can change the picture size in the teletext mode.
20. ◀◀ SUBPAGE	To play the previous chapter, title or track. Display the submenu of the text.
21.SOURCE	Select the input source.
22.REVEAL	Display or remove the content that is hidden.
23.ASPECT	Switch the screen ratio: auto, 4:3, 14:9, zoom1, zoom2.
24.RECALL	Switch to the previously viewed channel.
25.CH +/-	Press +/- button to switch the channels.
26.REC	Press to start recording.
27.SLEEP	Press the button repeatly to set the time to turn off the TV.
28. [▲] [▼] [▶] [◀]	Direction button.
29.EXIT	Exit the current menu.
30.SUB	Start the subtitle mode.
31. ■	Press the button to stop the current program.
32. ▶▶ INDEX	To play the next chapter, title or track. Display a list and information about the teletext pages.

Using the OSD MENU

The On-Screen Display (OSD) menu system provides a quick and simple method to adjust LED TV base setting. OSD menu can be viewed using both the remote control and the control buttons on the front panel.

Channel Adjustment

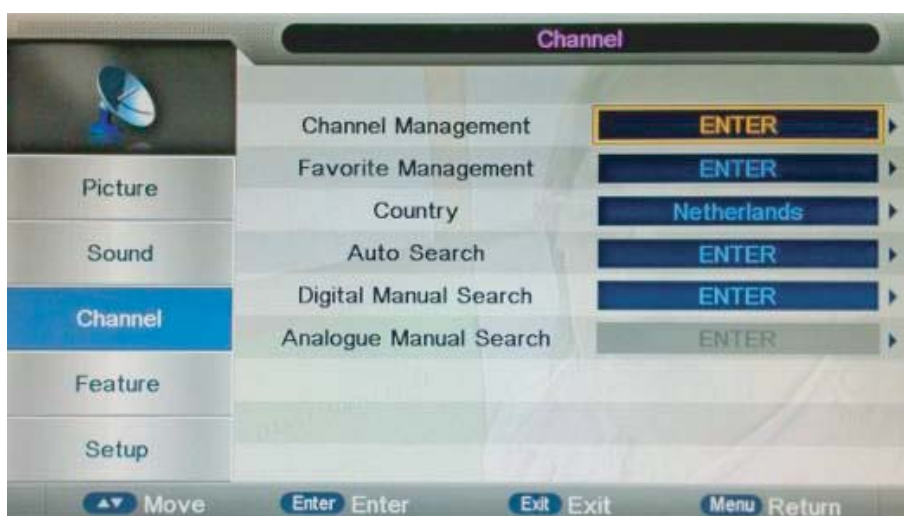

1. Press MENU button on the front panel or MENU button on the remote control to display the main menu.
2. Press ▲/▼ buttons on the remote control or CH +/- buttons on the front panel to select the Channel Setting menu, then press OK or ▼ buttons for the submenu.
3. Press ▲/▼ buttons on the remote control or CH +/- buttons on the front panel to select the item you want to adjust.
4. Press OK button on the remote control and press ▲/▼ ◀/▶ buttons to change the status.
5. Press MENU button to go to the previous menu.

After changes settings of the OSD menus, the new settings are confirmed automatically when OSD picture vanish, even did not press the menu to exit the OSD system.

Channel Adjustment

Sub windows info:

There are following functions in this page:

Channel Management: To manage (Delete/Rename/Swap/Lock/Skip) all channels;

Favorite Management: To manage (Add/Delete) Favorite channels;

Country: To select country.

Auto Search: To select auto search mode (All/Digital/Analogue);

Digital Manual Search: To search digital channel by entering parameters manually;

Analogue Manual Search: To search analogue channel by entering parameters manually.

Channel management



Channel Edit:

Press ▲/▼ button to select the channel you want to edit.

Press the red button on the remote control to lock the channel;

Press the green button on the remote control to delete the channel;

Press the yellow button on the remote control to skip the channel;

Press the blue button on the remote control to swap the channel;

Favorite Management



Press the fav button on the remote control to select the programs to be added into favorite list and press "RED", "GREEN", "YELLOW" or "BLUE" key to mark them .

Channel Adjustment

County

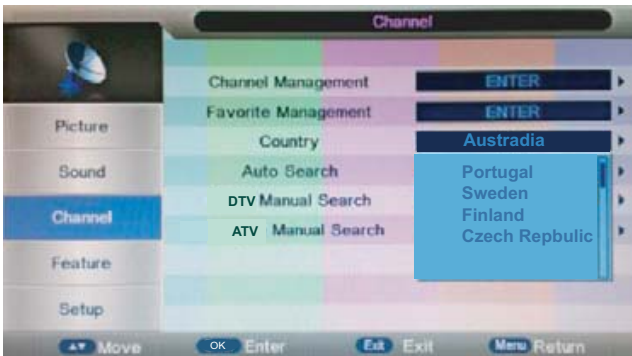

Press ▲/▼ button to select the county that you want.

Auto Search

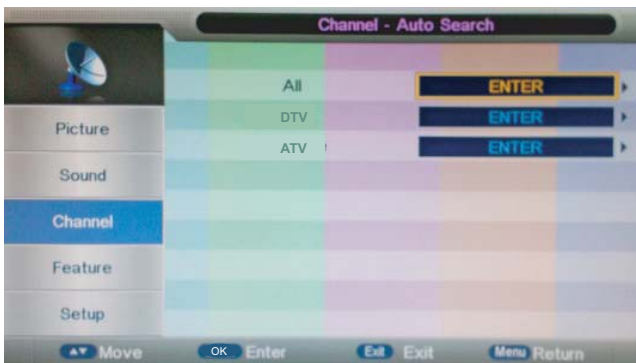

All Mode: Select "All" item to scan all digital channels carried by current signal mode firstly and then switch to scan all analog channels in selected country automatically. User can skip digital search to analog search directly by entering "EXIT" or "MENU" key and can also stop auto scan directly by entering "EXIT" or "MENU" during analog scanning.

Digital Mode: Select "Digital" item to search all digital channels in selected country carried by current signal mode. User can stop search directly by entering "EXIT" or "MENU" key.

Analog Mode: Select "Analogue" item to search all digital channels in selected country carried by current signal mode. User can stop search directly by entering "EXIT" or "MENU" key.

All search mode processing interface display as following:



Channel Adjustment

DTV Manual Search



Select channel number by “RIGHT” key or entering number directly. The strength and the quality as shows . Press “ENTER” key on “Start” item to start current channel search. The manual searching UI and the auto searching UI are the same.

ATV Manual Search

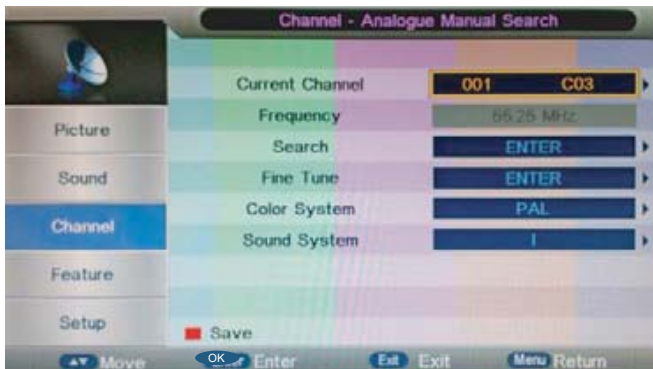

ATV Manual Search

Analog Parameters	Value	Default
Current Channel	001-100	001
Frequency	Show the Frequency when srech	Frequency of the current channel
Search	Press the button “enter ” to open the search sub page.	
Fine Tune	Press the button “enter ” to open the fine tune sub page.	
Color System	Auto/PAL/SECAM	Color System of the current channel
Sound System	BG/DK/I/L/L'	Sound System of the current channel

Picture Adjustment



1. Press MENU button on the front panel or MENU button on the remote control to display the main menu.
2. Press ▲/▼ buttons on the remote control or CH +/- buttons on the front panel to select the Aicture Setting menu, then press OK or ► buttons for the submenu.
3. Press ▲/▼ buttons on the remote control or CH +/- buttons on the front panel to select the item you want to adjust.
4. Press OK button on the remote control and press ▲/▼ ◀/▶ buttons to change the status.
5. Press MENU button to go to the previous menu.

Sub windows info:

Picture Mode	Press “ OK ” button to enter Picture Mode, then press ▲/▼ buttons to select : Dynamic, Standard, Mild, User.
Brightness	Press “ OK ” button to enter Brightness, then press ◀/▶ buttons to adjust the brightness of the picture.
Contrast	Press “ OK ” button to enter Contrast, then press ◀/▶ buttons to adjust the contrast of the picture.
Sharpness	Press “ OK ” button to enter Sharpness, then press ◀/▶ buttons to adjust the sharpness of the picture.
Colour	Press “ OK ” button to enter Colour, then press ◀/▶ buttons to adjust the colour of the picture.
Colour Temp	Press “ OK ” button to enter Colour Temp, then press ▲/▼ buttons to select: Cold, Normal, Warm.
Noise Reduction	Press “ OK ” button to enter Noise Reduction, then press ▲/▼ buttons to select: off, low, middle, high, default.

Sound Adjustment



1. Press MENU button on the front panel or MENU button on the remote control to display the main menu.
2. Press ▲/▼ buttons on the remote control or CH +/- buttons on the front panel to select the Sound Setting menu, then press OK or ► buttons for the submenu.
3. Press ▲/▼ buttons on the remote control or CH +/- buttons on the front panel to select the item you want to adjust.
4. Press OK button on the remote control and press ▲/▼ ◀/▶ buttons to change the status.
5. Press MENU button to go to the previous menu.

Sub windows info:

Sound Mode	Press “ OK ” button to enter Sound Mode, then press ▲/▼ buttons to select : Standard, Movie, Music, Speech, User, Off.
Bass	Press “ OK ” button to enter Bass, then press ◀/▶ buttons to adjust the low frequency content of audio output.
Treble	Press “ OK ” button to enter Treble, then press ◀/▶ buttons to adjust the high frequency content of audio output.
Balance	Press “ OK ” button to enter Balance, then press ◀/▶ buttons to adjust the audio output between left and right speakers.
Surround	Press “ OK ” button to enter Surround, then press ▲/▼ buttons to adjust Surround mode:On,Off.
AVL	Press “ ▲/▼ ” button to adjust AVL mode: On,Off.
SPDIF	Press “ ▲/▼ ” button to adjust SPDIF mode: Auto,Off,PCM.

Feature Adjustment

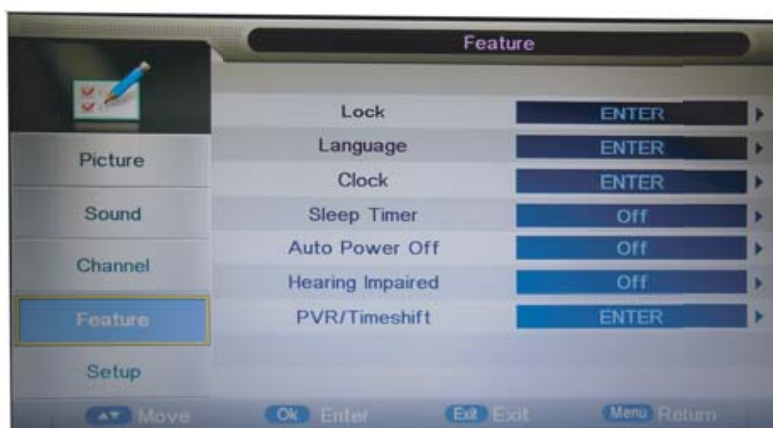

1. Press MENU button on the front panel or MENU button on the remote control to display the main menu.
2. Press ▲/▼ buttons on the remote control or CH+/- buttons on the front panel to select the Feature Setting menu, then press OK or ► buttons for the submenu.
3. Press ▲/▼ buttons on the remote control or CH +/- buttons on the front panel to select the item you want to adjust.
4. Press OK button on the remote control and press ▲/▼◀/▶ buttons to change the status.
5. Press MENU button to go to the previous menu.

Sub windows info:

Lock	Press “ OK ” button to enter Lock, The Lock sub page includes four parts:Lock Enable,Parental Guidance,Change Pin Code,Hotel Mode.
Language	Press “ OK ” button to enter Language, then press ▲/▼ to select Language that you want.
Clock	Press ◀/▶ to check out the current system time and set time zone/DST
Sleep Timer	Press “ OK ” button to enter Sleep Timer, Then press ▲/▼ buttons to set sleep timer:Off,10 Mins, 20 Mins,30Mins, 60Mins, 90 Mins, 120 Mins, 180 Mins, 240 Mins,
Auto Power Off	Press “ OK ” button to enter Auto Power Off, then press ▲/▼ buttons to set auto standby : off, 1H, 2H, 4H.
Hearing impaired	Press ▲/▼ to select Hearing impares On or Off.

Setup Adjustment



1. Press MENU button on the front panel or MENU button on the remote control to display the main menu.
2. Press ▲/▼ buttons on the remote control or CH +/- buttons on the front panel to select the Setup Setting menu, then press OK or ► buttons for the submenu.
3. Press ▲/▼ buttons on the remote control or CH +/- buttons on the front panel to select the item you want to adjust.
4. Press OK button on the remote control and press ▲/▼ ◀/▶ buttons to change the status.
5. Press MENU button to go to the previous menu.

Sub windows info:

OSD Timer	Press ▲/▼ button to select OSD Timer:5, 10, 15, 20, 25, 30 Seconds.
PC Setup	Set PC(Only available in PC source).
Blue Screen	Select Blue Screen mode between On and Off.
Reset TV Setting	Reset to default setting.
Software Update	Using the USB device to update sofeware.

Media OPERATION



Note: Before operating Media menu, Plug in USB device, then press INPUT button to set the Input Source to Media.

1. Press ▼ / ▲ button to select Media in the Source menu, then press OK button to enter.
2. Press ◀ / ▶ button to select the option you want to adjust in the main menu, then press OK button to enter.

Sub windows info:

PHOTO	Press ◀/▶ button to select PHOTO in the main menu, then press OK button to enter. Select the file you want to watch. Press menu button to return back to the previous menu and Exit button to quit.
MUSIC	Press ◀/▶ button to select MUSIC in the main menu, then press OK button to enter. Select the file you want to watch. Press menu button to return back to the previous menu and Exit button to quit.
MOVIE	Press ◀/▶ button to select MOVIE in the main menu, then press OK button to enter. Select the file you want to watch. Press menu button to return back to the previous menu and Exit button to quit.
e-Book	Press ◀/▶ button to select e-Book in the main menu, then press OK button to enter. Select the file you want to watch. Press menu button to return back to the previous menu and Exit button to quit.

Specifications

Display		I/O ports	
Active screen size	31.5 inches	HDMI input	3
Aspect ratio	16:9	PC input	1
Response time	7ms	PC audio input	1
Resolution	1366*768	YPbPr input	1
Contrast	4000:1	AV input	1
Brightness	200	RF input	1
Viewing angle	176/176(H/V)	USB input	1
		SPDIF output	1
		Headphone output	1
TV Functions		Other	
Tuner	1	User manual	√
Number of channel	100	Dimensions (W*H*D)	738mm×491mm×160mm
Standards	B/G, D/K	Packing size (W*H*D)	839mm×584mm×165mm
Color system	PAL, SECAM		
AV		Gross weight	16Kg
Progressive scan	√	Power consumption	70w
3:2/2:2 pull down	√		
Noise reduction	√		
Audio			
Speaker	2 × 8w		
Audio mute	√		
Function			
Zoom mode	Auto, 4:3, 14:9, Zoom1, Zoom2		
Picture mode	Dynamic, Standard, Mild, Personal		
OSD languages	English, French, Deutsch, Italian, Spanish, Portuguese		
Return	√		
Sound mode	Standard, Music, Movie, Sports, Personal		
Audio setting	√		
Auto off	√		
Sleep timer	√		

* All specifications are subject to change without notice

Troubleshooting

No power

- Make sure the TV and the power cord are connected correctly.
- Check if you pressed POWER on the remote control unit. If the indicator in the front panel is red, press POWER in the remote control or the front control panel.

LED TV does not operate

- External influences such as lightning or static electricity may cause improper operation. In this case, operate the unit after first turning on the power, or un plugging the AC cord and plugging it in again after 1 to 2 minutes.

Power is cut off suddenly

- Check if the off timer or sleep timer are set.
- The unit's internal temperature has increased. Remove any objects blocking the vents and clean them to remove dust.

Remote control unit does not operate

- Check if the batteries are inserted with the polarity (+,-) correctly aligned.
- Check if the batteries are discharged. Please replace with new batteries.
- Make sure that you do not use the remote control under strong or fluorescent lighting.
- Check if there is a fluorescent light illuminated near the remote control sensor.
- The path of the remote control beam may be blocked; please make sure the path is clear and that remote control is aimed at the remote control sensor in the TV.

Picture is cut off /with side bar screen

- Check if the image position is correct.
- Check if the screen mode adjustments such as picture size are made correctly.

Strange color, light color, or color misalignment

- Is the room too bright? The picture may look dark in a room that is too bright.
- Check the input signal setting.

Palsonic

The AUSTRALIAN Company

Palsonic Customer Service
Telephone (Australia) 1300 657 888

Palsonic Corporation Pty Ltd ABN 34 000 474 108
1 Joynton Avenue, Waterloo NSW 2017 Australia

Telephone (02) 9313 7111 Facsimile (02) 9697 0655
www.palsonic.com.au