

55039

Kenmore

I N S T R U C T I O N S

MODEL 68/95/96/1600/1650/1651/1652/1654/1750



ZIG-ZAG SEWING MACHINE

P/N 55039

**TABLE OF
CONTENTS**

Adjusting for Good Stitches	38	Overcasting	27
Adjusting Pressure of Presser Foot.....	10	Parts List	36 - 37
Adjusting Tensions	12 - 13	Picking Up Bobbin Thread	10
Applique	26	Placement of Needle	5
Basting	11	Removing Bobbin Case from Shuttle	6
Blind Stitching	19	Reverse Stitching	11
Buttonholes	20 - 25	Replacement of Belt	31
Changing the Presser Foot	15	Setting Stitch Length	11
Cleaning and Oiling	31 - 33	Setting Stitch Width	16
Connecting Machine.....	4	Sewing Light.....	4
Darning	18	Sewing on Buttons.....	19
Decorative Stitching	17	Sewing on Lace	26
Double Needle	28 - 29	Sewing on Plastic Films	30
Fastening a Seam	15	Sewing on Stretch Fabrics	27
Feed Dog Control.....	15	Sewing with Reverse Pattern Disc.....	16
Identification - Head Parts	2 - 3	Straight or Three - Cornered Tear	26
Inserting Bobbin into Bobbin Case	8	Synthetics	30
Inserting Pattern Disc.....	16	Threading Upper Machine	9
Inserting and Removing Material.....	14	Turning a Corner.....	15
Installing Machine Head	4	What to Do.....	34 - 35
Needle and Thread Table	5	Winding the Bobbin.....	7
Needle Size	5	Writing and Monogramming.....	27

FRONT VIEW

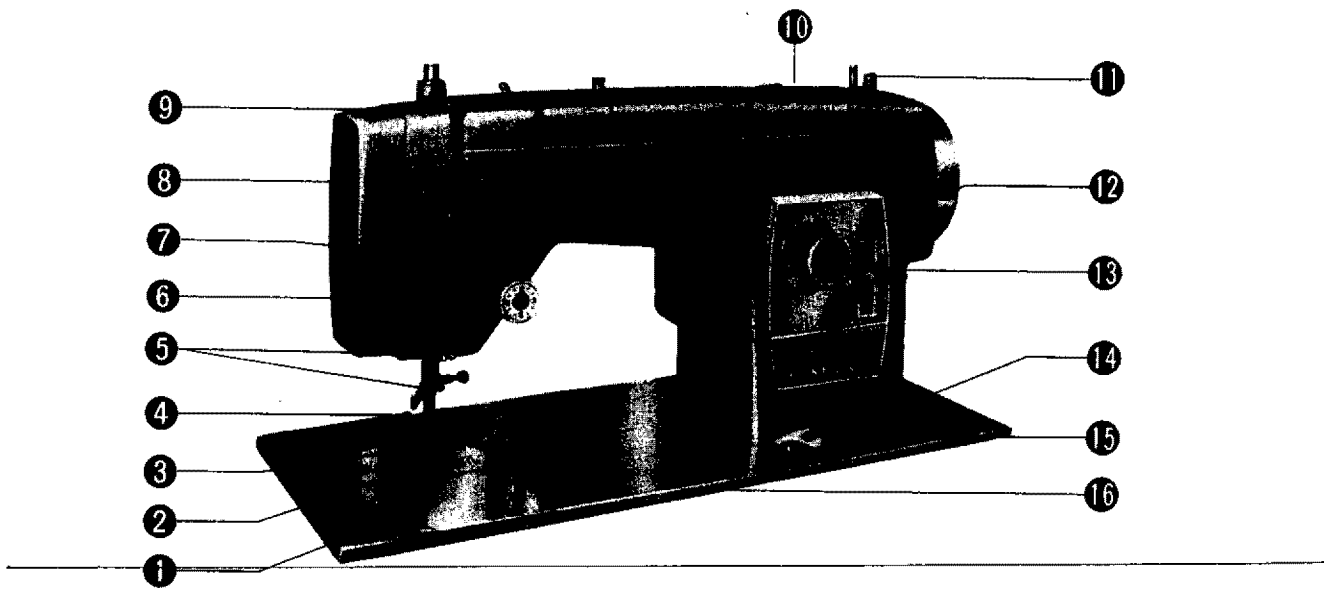

- 1. Hand Hole Cover Plate
- 2. Feed Dog
- 3. Presser Foot
- 4. Presser Foot Thumb Screw
- 5. Thread Guides
- 6. Thread Tension Assembly

- 7. Thread Guide
- 8. Face Cover Plate
- 9. Thread Take-up
- 10. Arm Cover Plate
- 11. Bobbin Winder Mechanism

- 12. Stitch Width Control Knob
- 13. Stitch Length Control Lever
- 14. Light Switch
- 15. Feed Dog Control Knob
- 16. Nomenclature Plate

BACK VIEW

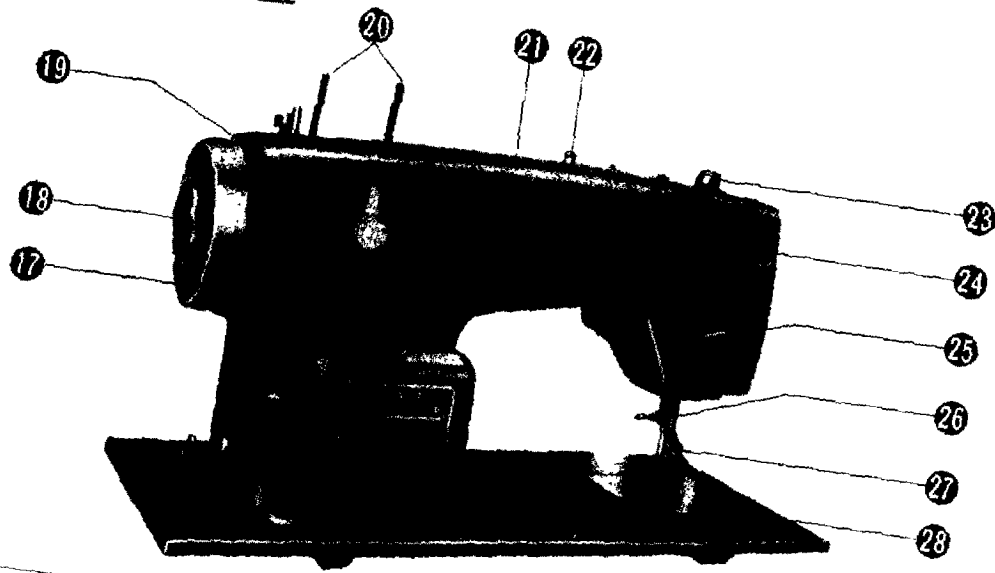

- 17. Hand Wheel
- 18. Clutch Knob
- 19. Buttonhole Reverse Stitch Length Control
- 20. Upper Thread Spool Pins

- 21. Pattern Disc Shaft Cover
- 22. Bobbin Winder Tension Disc
- 23. Presser Foot Knob
- 24. Upper Thread Guides

- 25. Presser Foot Lever
- 26. Needle Clamp Screw
- 27. Thread Cutter
- 28. Needle Plate

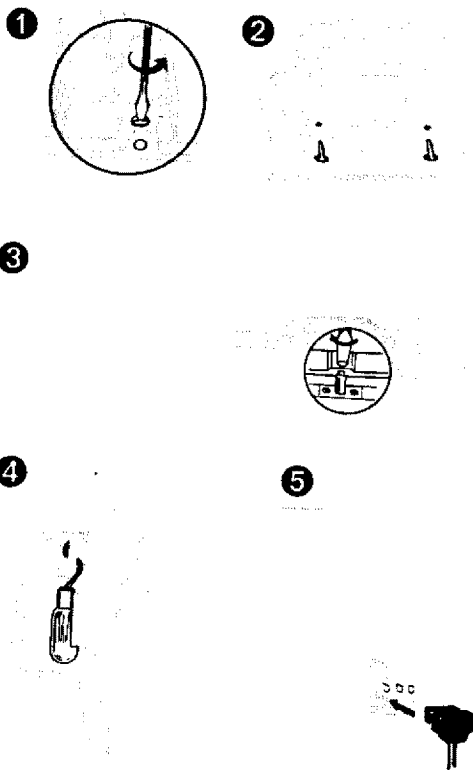

INSTALLING MACHINE HEAD IN PORTABLE AND CABINET

Loosen the two hinge screws under holes in the rear edge of the machine bed (1). Raise hinge pins in the cabinet cutout (2). Slip machine head onto the pins and tighten hinge screws securely (3). Lower machine head to front flap.

Screw spool pins in place. Lay the plastic discs over the spool pins. Discs and pins are packed in the accessory box.

SEWING LIGHT

The sewing light is located inside the face cover plate as shown. It may be turned on or off by pushing the light switch. In order to operate the machine the switch must be on.

To remove bulb, turn light switch off, open the face cover plate by swinging it open, push bulb in slightly, turn bulb clockwise, and remove from socket. To replace, push in new bulb and turn counter clockwise. See illustration 4.

CONNECTING MACHINE

Push the plug onto three-prong connector under the bed plate. Plug machine cord into any 110-120V wall outlet. See illustration 5.

NEEDLE AND THREAD TABLE

THREAD SIZE	NEEDLE SIZE	FABRIC
Cotton 60-100 Synthetic Silk A	11	Sheer cottons, silks, and synthetics Fine laces
Cotton 60-80 Mercerized 50 Synthetic Silk A	14	Medium weight cottons Medium weight silks Medium weight synthetics Light weight woolens
Cotton 40-60 Mercerized 50 Mercerized heavy duty	16	Heavy weight cottons Medium to heavy weight woolens Heavy drapery fabrics
Cotton 30-50 Mercerized heavy duty	18	Heaviest cottons as for men's work clothes Heaviest woolen coating

NEEDLE SIZE

Use **KENMORE 6021** needles. The size of the needle should conform to the size of the thread and both should be suitable to the material. The same size thread should be used in the bobbin as on the upper part of the machine for ordinary sewing. Never use a bent needle nor one with a blunt point.



This is the exact length of the needle to be used in your machine. Comparison with this illustration will determine whether the needle you have is the correct one for your machine.

PLACEMENT OF NEEDLE

Raise needle bar to its highest position by turning hand wheel toward you. Loosen needle clamp screw. Hold the needle with flat side away from you. Slip the needle as far as it will go into the needle clamp, and tighten the needle clamp screw.

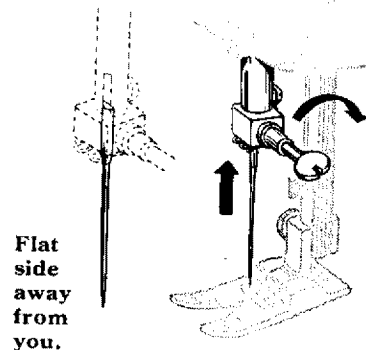

Flat side away from you.

Needle at its highest position.



Pull out latch.

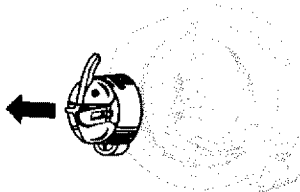

Pull bobbin case straight out.

REMOVING BOBBIN CASE FROM SHUTTLE

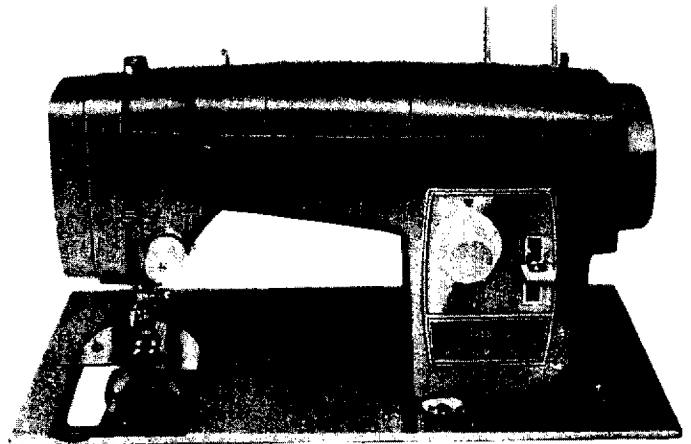

WINDING THE BOBBIN

1

Place thread on spool post. Draw thread as shown.



4

Release clutch by turning clutch knob toward you. Start machine.

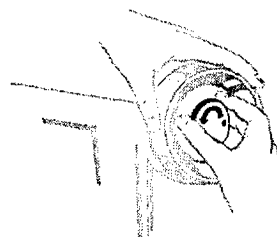

2

Wind thread around bobbin a few times.

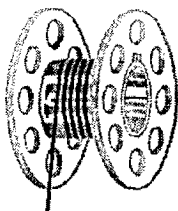

5

When bobbin is full, winding mechanism stops.

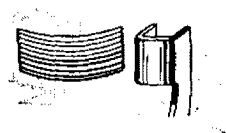

3

Place bobbin onto bobbin winder shaft. Push bobbin winder latch until it clicks.

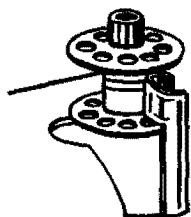

6

Tighten clutch knob and remove bobbin.

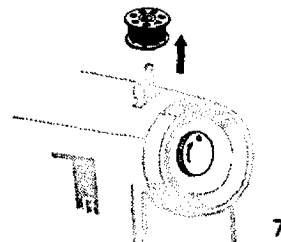

INSERTING BOBBIN INTO BOBBIN CASE.....CASE INTO SHUTTLE

- ① Guide bobbin onto center pin of bobbin case.
- ② Pull thread through slot.
- ③ Pull thread under tension spring.
- ④ Holding latch, position case into shuttle, release latch.

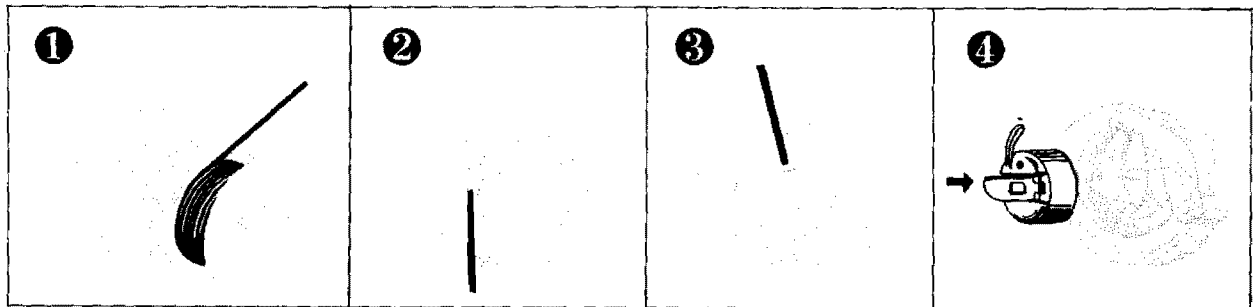

THREADING UPPER MACHINE

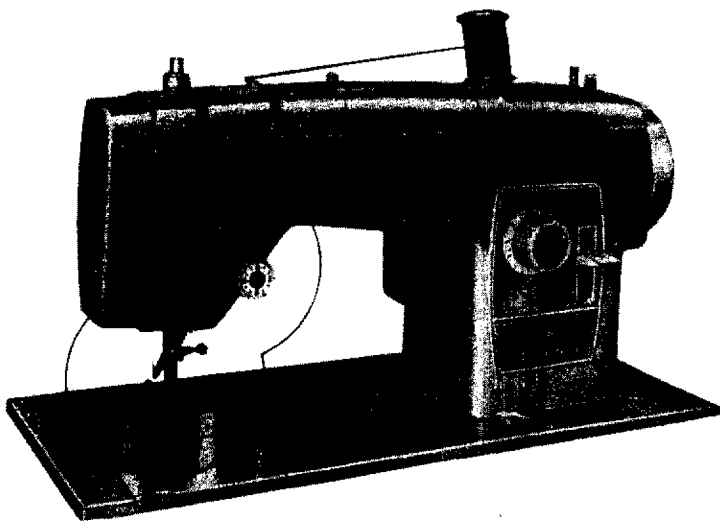

Place thread as illustrated between discs of the Thread Tension Assembly. Prevent the spool of thread from turning and by holding the end of the thread pull spring wire loop up and past the top hook until the thread can be slipped into the hook. When thread tension is released, the spring wire loop will return to position as shown with the thread in proper place. Release spool of thread and continue to thread machine as illustrated.

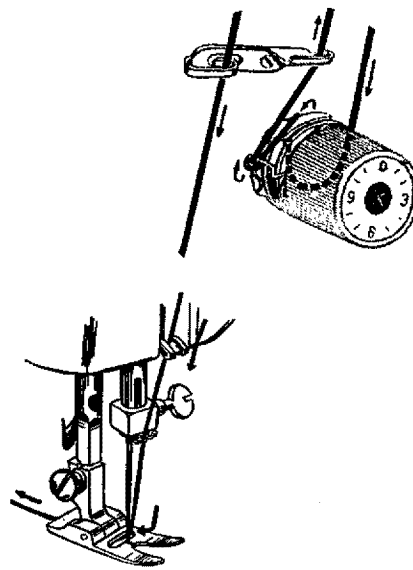

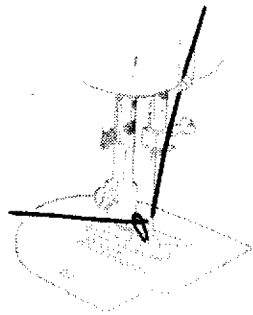

PICKING UP BOBBIN THREAD

Raise presser foot lever.
Hold needle thread loosely in left hand and rotate hand wheel toward you one complete turn.
Bring bobbin thread up by pulling upper thread.
See illustration.
Place threads back under presser foot.

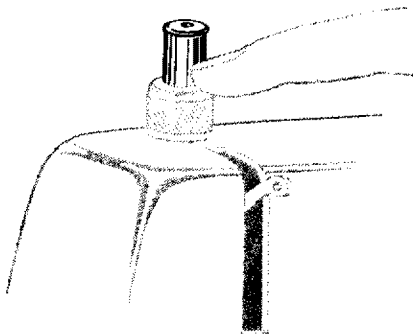

ADJUSTING THE PRESSURE OF THE PRESSER FOOT

Push down outer ring of presser foot knob (See illustration). This will release pressure of presser foot. To increase pressure, push down inner pin until suitable pressure is obtained.

For ordinary sewing, the inner pin should be about half way down. When sewing multiple thickness or heavy material, reduce the pressure. Increase it when sewing sheer fabrics.

Insufficient pressure may cause skipped stitches or difficulty in guiding the fabric. If feed dog or presser foot marks appear on the fabric, reduce the pressure.

SETTING STITCH LENGTH

The stitch length lever controls the stitch length. Set lever to any desired stitch length position between 0 and 4 by turning knob until the indicator is aligned with the stitch length number desired.

The red mark indicates the setting for a satin stitch. This will vary slightly depending upon the type of material to be sewn. At No. 4 the longest stitch is obtained. The size of stitch you select will depend on fabric you are sewing. Straight stitching is done with stitch width control on 0 setting and by removal of pattern disc.

REVERSE STITCHING

Raise lever for reverse stitching. Lower lever for forward stitching. It is best to begin and end most seams with reverse stitching often called back tacking.

BASTING

For accomplishing quicker, more even and firmer basting, we suggest you regulate the machine in the following manner; Set stitch length at No. 4 for the longest possible stitch. Machine should be threaded in normal manner except bypassing the check spring as illustrated. Basting is easily removed by pulling bottom thread. When basting very sheer fabrics, use a paper backing.

If you prefer to use pins for basting, your KENMORE will sew over the pins. Be sure to keep the pins at right angles to the seam and the head of the pin away from the presser foot. Also reduce pressure on presser foot.

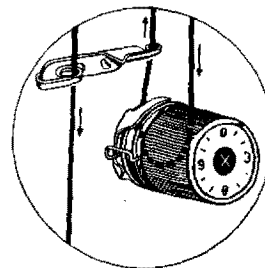
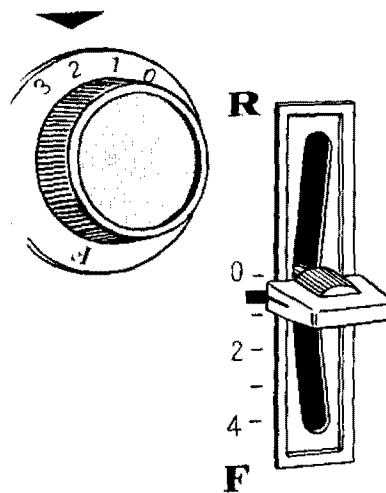

ADJUSTING TENSIONS

1



Fig. 1

A perfect stitch will have threads locked between the two layers of fabric with no loops on top or bottom. (Refer to page 38)

PROBLEM

REMEDY

2

Upper thread too tight



Fig. 2

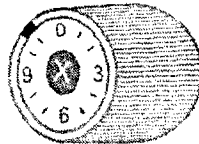

Decrease Tension

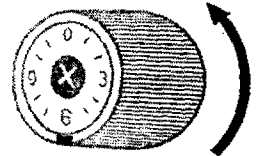

3

Upper thread too loose



Fig. 3

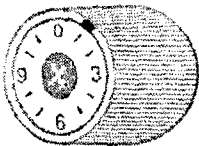

Increase Tension

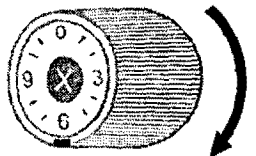

When stitching is unsatisfactory as in figures 2 and 3, adjust the upper thread tension. Lower thread tension requires adjustment less frequently than the upper thread tension.

When stitch is satisfactory, as in figure 1 and seam is badly puckered, the cause may be tight tensions and both upper and lower may be adjusted.

When adjusting the tension on the bobbin case, make slight adjustments with a screwdriver. (See page 38)

It is necessary to reduce the upper thread tension somewhat when doing decorative stitching. As the stitch width is increased, the tension should be decreased.

INCREASE TENSION

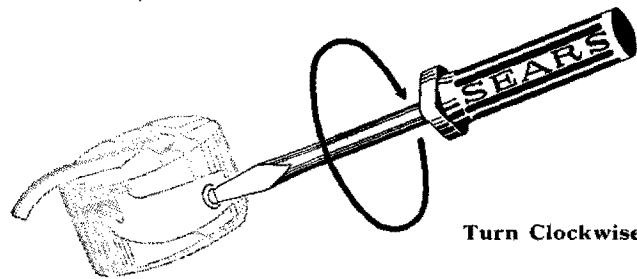

Turn Clockwise.

DECREASE TENSION

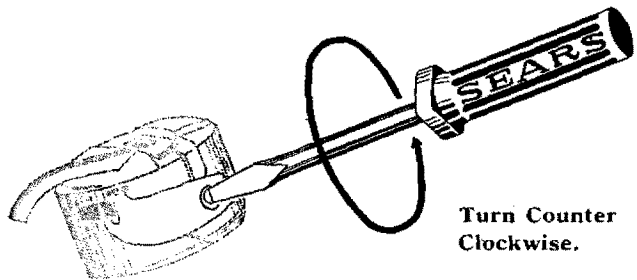

Turn Counter Clockwise.

INSERTING AND REMOVING THE MATERIAL

For all kinds of sewing, consult chart page 5.

Before placing the material on the machine see that:

- * The presser foot and needle clamp screws are both tight.
- * The sizes of needle and thread suit the kind of work to be done.
- * The needle and take-up lever are at their highest position.
- * The tensions have been properly adjusted.
- * The ends of the threads have been drawn about 4 inches to the rear of the machine.
- * The feed dog is up.
- * Stitch length and width controls are set at desired settings.

Experiment by sewing on the fabric to be used to determine tension adjustments and correct stitch settings.

Place material under the presser foot, insert the needle into the material by turning the hand wheel toward you, lower presser foot and start sewing. To facilitate placement of heavy fabrics under the presser foot, the presser foot lever can be raised beyond the normal "up" position.

To remove the work, first turn hand wheel toward you until needle is at its highest position, then raise the presser foot, draw material to the rear and cut off excess thread with the thread cutter located on the presser bar.

IMPORTANT: Always turn the hand wheel toward you! When machine is not being used, place a piece of material over the feed dog and lower the presser foot. Always have fabric under the presser foot when operating the machine. Operating threaded machine without fabric will cause it to jam by forcing thread into the shuttle. See pages 32 and 33.

CHANGING THE PRESSER FOOT

The various attachment feet available for certain kinds of work are to be fastened to the presser bar.

To attach the foot, raise the presser bar to its highest position by raising the presser foot lever. Loosen the presser foot thumb screw, choose the proper foot, insert from the front. Tighten the screw using the large screw driver and make sure that the foot is secure.

TURNING A CORNER

Stop sewing machine with needle in fabric. Raise presser foot. Turn fabric. Lower presser foot and continue stitching.

FASTENING A SEAM

Be sure both threads are drawn back under the presser foot. Lower needle into fabric about $\frac{1}{2}$ inch from beginning of seam. Push stitch length control lever up for reverse stitching. Stitch in reverse until needle reaches beginning of seam.

Move stitch length control lever down for forward stitching and complete seam. When you reach the end, raise the stitch length control lever and sew back over $\frac{1}{2}$ inch of completed seam.

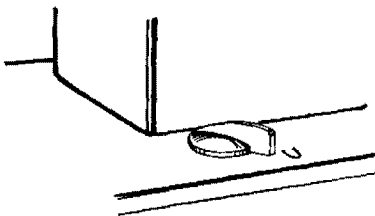
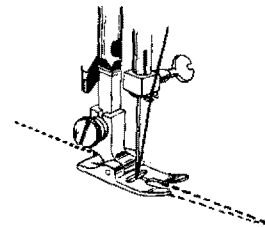
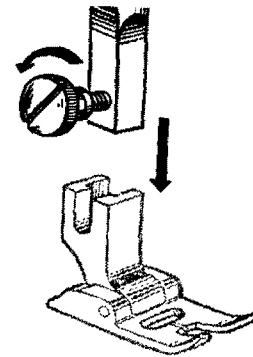

FEED DOG CONTROL

The feed dog control knob is situated on the right front of machine bedplate. When knob is turned to the left, feed dog drops and does not pull material. This allows the operator freedom of movement of material, as for darning. For regular sewing, turn knob to the right, "U" (Feed dog up).

ZIGZAG CONTROL

SETTING STITCH WIDTH

Insert disc #1. Turn the stitch width knob to the desired setting between 0 and 4 on the knob. Zigzag stitch width increases from 1 to 4. Straight stitching is possible only with control on 0 setting, or by removal of pattern disc.

When sewing with the double needle the stitch width control must not be advanced beyond 2½ setting.

INSERTING PATTERN DISC

1. Turn handwheel so that the needle is in its highest position.
2. Pull pattern disc shaft cover open.
3. Grasp pattern disc and slip disc onto the shaft. Make sure the retaining pin **A** enters hole in disc.

To start a pattern at the beginning, align the engraved dot on the disc with the cam follower **B**. To do this, slip the disc onto the shaft so the engraved dot is at or as near (counterclockwise) the cam follower as possible. If the engraved dot is not aligned with the cam follower, turn the hand wheel toward you until the dot is aligned. (If the machine is threaded, be sure to place a scrap of fabric under the presser foot).

To remove pattern disc, follow steps 1 and 2, grasp disc and pull from shaft.

SEWING WITH REVERSE PATTERN DISC

Your machine is provided with four reverse pattern discs, discs numbers 21, 22, 23 and 24. When using these pattern discs, the stitch length control should be set at 4. The reverse stitch length control **C** should be in the upright position for most materials. Depending upon the type of fabric used, this control may need adjusting. Turn the control slightly to the right or to the left as required to obtain the patterns illustrated on page 17. Practice on an extra piece of fabric to be used.

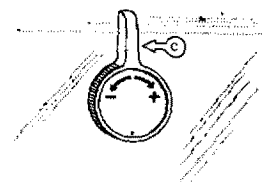
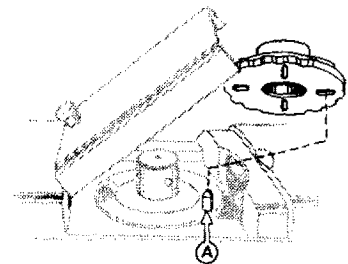
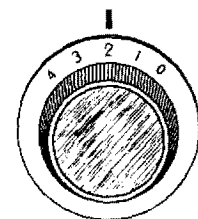

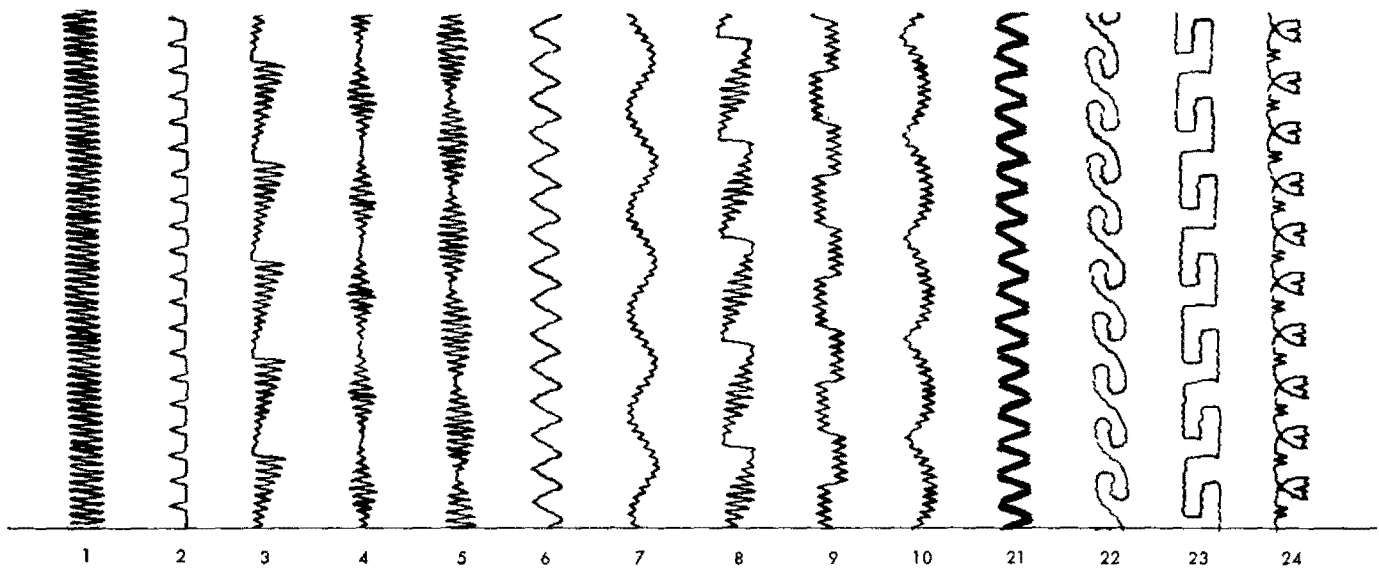

DECORATIVE STITCHING

This machine enables you to sew beautiful decorative and embroidery stitches by means of various discs supplied with your machine. The movements of the needle are controlled by the disc. Basic decorative stitches are made with the satin stitch foot, stitch width at 4 and stitch length at the red mark on the indicator plate. Stitch length will vary slightly depending upon the type of material to be sewn. Pattern may be changed by using any other length or width. All patterns also can be made with double needle. See page 25. When using the disc numbers 21, 22, 23 and 24, the stitch length control should be set at 4. Disc number 21 also makes the stretch stitch when it is used as directed in the instructions for Sewing on Stretch Fabrics. See page 27.

It is necessary to reduce the upper thread tension somewhat for decorative stitching. As the stitch width is increased, the tension should be decreased. This will prevent the material from puckering and will prevent the bobbin thread from coming up on the top of the fabric.

DARNING

WITH PRESSER FOOT :

1. Turn feed dog control to left.
2. Press down outer ring of presser foot knob, see page 10. With presser foot knob in this position, mending, darning, monogram work, etc. may be done.
3. Stretch fabric tightly between two spring embroidery hoops and place under needle.
4. Lower presser bar so thread will have some tension. When you start to darn, move fabric back and forth to cover darning area. Then turn fabric and continue sewing at right angles to the previous stitching. Use medium machine speed. You can make any length stitches desired. Slow movement of fabric will make short darning stitches. Fast movement will make long stitches.
5. When you finish darning, raise presser foot and remove fabric. Increase pressure for general sewing by pressing down inner pin of the presser foot knob. Turn feed dog control to right.

WITHOUT PRESSER FOOT :

1. Turn feed dog control to left.
2. Remove presser foot.
Proceed as directed under steps 3 and 4 above.
3. When you finish darning, raise the presser foot lever and remove fabric. Replace presser foot, and increase pressure for general sewing. Turn feed dog control to right.

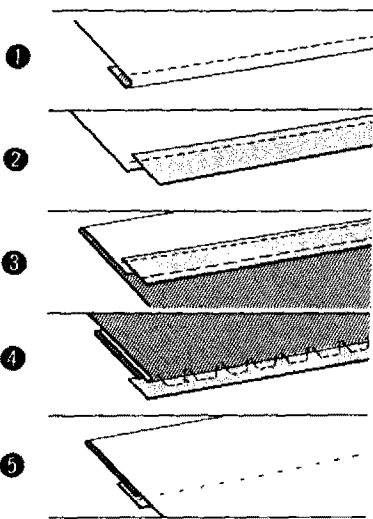
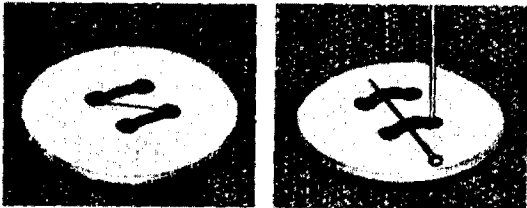

SEWING ON BUTTONS

Use disc # 1

Align two holes of button with slot of presser foot and lower foot to hold securely. Drop feed dog. Turn hand wheel by hand until needle point is just above button. Adjust stitch width so that needle will align with a hole of button. Turn hand wheel again by hand so that needle goes into second hole, readjust stitch width if necessary. Stitch a number of times, turning hand wheel manually. Finish sewing with an extra 2 inches of thread, draw thread to reverse side and tie securely.

If using a 4 hole button repeat the above procedure.

NOTE: To make a small thread shank when sewing on a flat button, place a straight pin or needle between the holes of the button.

BLIND STITCHING

Disc # 2

Stitch width 2

Stitch length 3 (May vary depending on type of material)

1. Prepare the hem with a turned and edgestitched finish, or
2. Apply seam tape along the raw edge with either straight or zigzag stitching.
3. Turn hem and baste about $\frac{1}{4}$ inch from the edge of the seam tape using longest stitch on the sewing machine.
4. Fold garment back along basting line and stitch along garment fold using disc # 2.
5. Remove basting and press hem. The basting step may be eliminated in a straight hem.

BUTTONHOLES

(Models 68, 95, 1600,
1650, 1651, 1652)

Use disc #1 and special buttonhole foot
Stitch length at red mark
Buttonhole control knob F
Feed dog control U

Place the fabric, with the buttonhole length marked at both ends, under the buttonhole foot. Without lowering the foot, let the needle pierce the fabric at the beginning of the buttonhole. Set the foot so the beginning of the red zone (closest to the needle) is at the mark of the opposite end of the buttonhole. Lower the foot.

Stitch forward until the needle reaches the red zone on the front edge of foot. Then turn the knob to R, and stitch the other side of the buttonhole. Turn knob back to F to finish end of buttonhole. The speed with which the knob is turned determines the number of stitches at the ends of the buttonhole. The slower the knob is turned, while sewing, the more stitches are formed. See page 21.

Reproduction of identical size buttonholes is facilitated with the aid of the graduations on the left side of the buttonhole foot. These graduations are 1/8 inch apart. Just mark the starting points of the buttonholes, let the needle pierce the fabric and set the index mark (A) on the upper portion of the foot at the same graduation mark (B) as it was set for the first buttonhole. Lower the foot. Follow the procedures outlined above.

Always make a practice buttonhole on a scrap of fabric used in the garment, using a double thickness of fabric, and an interfacing if used in garment.

The stitch length may be varied slightly by the stitch length control lever within the 0 to 1 range. To increase forward stitch move this lever from the red mark toward 1, to decrease move it toward the 0. The buttonhole reverse stitch length control (C) is used to match the length of the reverse stitches with the forward stitches. Turn the dial to the minus direction for shorter stitches; to the plus direction for longer stitches. These settings may vary depending on the type of fabric used.

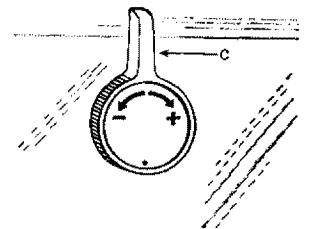
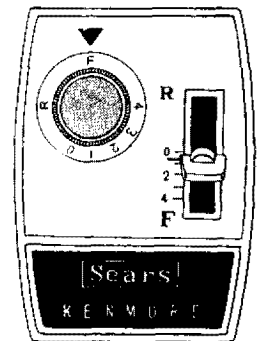
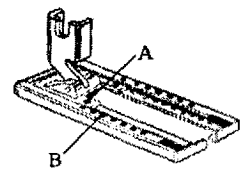

Position 1

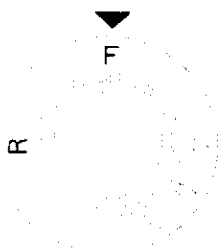

Step 1

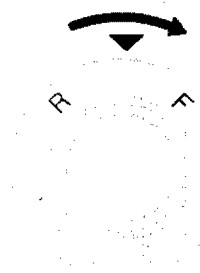

Position 2

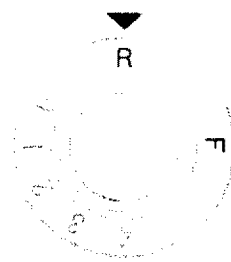

Step 2

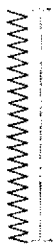

BUTTONHOLES

(Models 96, 1750)

Use disc # 1
Stitch width knob - about $1\frac{1}{2}$

Feed dog control - Left
Cover plate for buttonholes

1

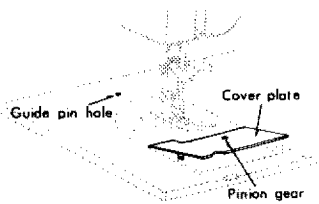

Remove regular cover plate and insert buttonhole cover plate.

2

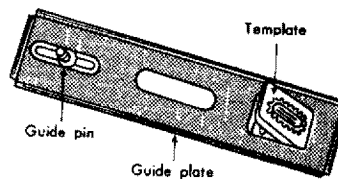

Select desired template and snap into guide plate.

3

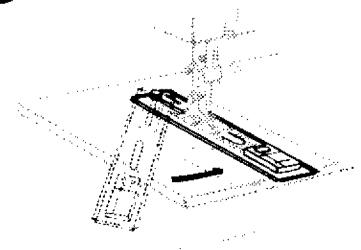

Pull guide plate all the way forward so that guide pin is at S. This will enable you to start at one end of the buttonhole. Screw guide pin on guide plate into guide pin hole on machine bed.

Drop guide plate into place with template fitting over the pinion gear.

4

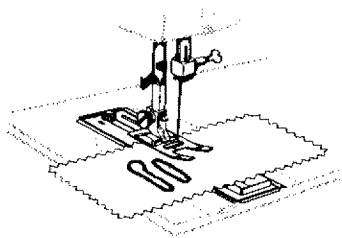

5

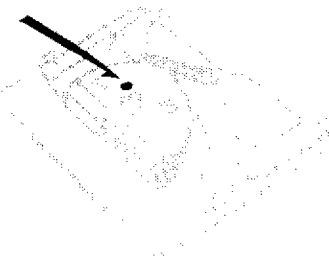

Pick up bobbin thread through guide plate and draw threads toward back. Place material on the guide plate. Drop presser foot and start sewing. Buttonhole will be formed. The buttonhole size and shape is not influenced by the stitch length knob so it may be set on any position.

An occasional drop of oil on the oiling hole provided on the back of the buttonhole cover plate will provide smooth operation of your buttonhole maker.

HINTS FOR PERFECT BUTTONHOLES

Mark the position of each buttonhole on the garment with chalk or a line of basting.

Loosely woven fabrics and fabrics that stretch easily such as jersey should have an interfacing of a firm fabric. Use cambric or taffeta between woolens and rayons-organdy or lawn between light weight and sheer fabrics.

Use buttonhole scissors or buttonhole cutter to cut buttonhole open.

Always make a practice buttonhole on a piece of the fabric to be used in the garment.

A wider stitch width may be desirable on heavy weight fabrics.

BUTTONHOLES

(Model 1654)

Use disc # 1
Stitch width knob - about 1½

Feed dog control - Left
Cover plate for buttonholes

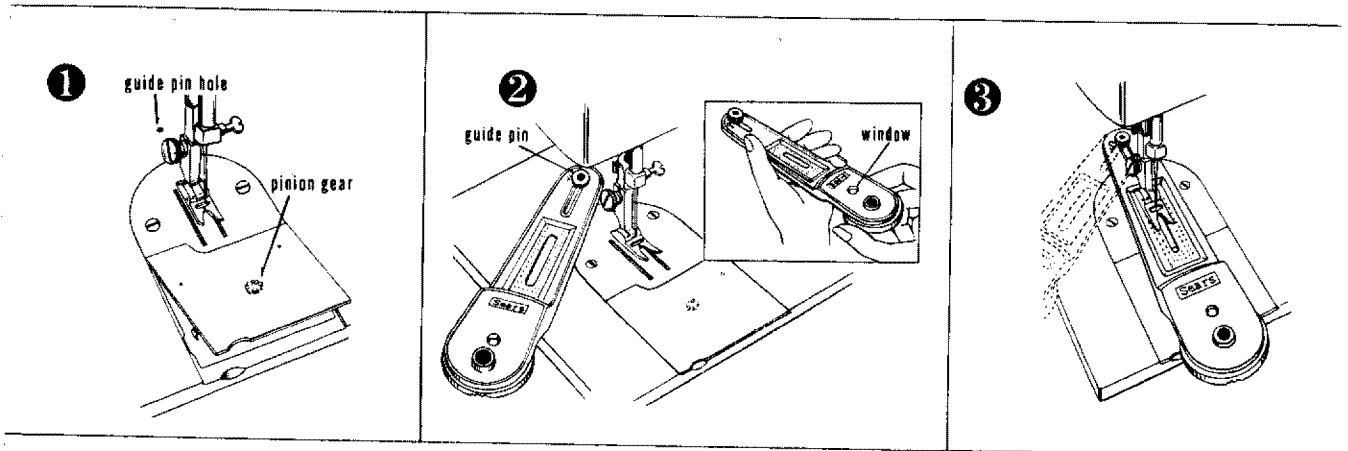

Remove regular cover plate and insert buttonhole cover plate.

Screw guide pin on guide plate into guide pin hole on machine bed. Select desired size of buttonhole by turning disc as shown above. Length of buttonhole appears in window on top side of guide plate.

Pull guide plate all the way forward so that guide pin is at S. This will enable you to start at one end of the buttonhole. Screw guide pin on guide plate into guide pin hole on machine bed.

Drop guide plate into place with template fitting over the pinion gear.

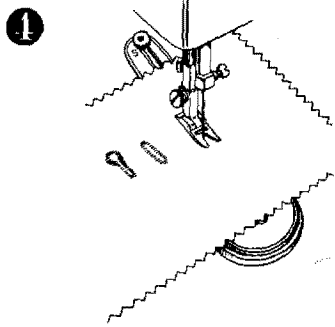

1 Pick up bobbin thread through guide plate and draw threads toward back. Place material on the guide plate. Drop presser foot and start sewing. Buttonhole will be formed. The buttonhole size and shape is not influenced by the stitch length knob so it may be set on any position.

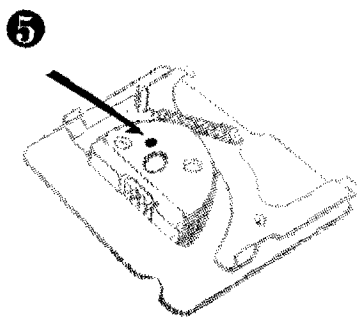

5 An occasional drop of oil on the oiling hole provided on the back of the buttonhole cover plate will provide smooth operation of your buttonhole maker.

HINTS FOR PERFECT BUTTONHOLES

Mark the position of each buttonhole on the garment with chalk or a line of basting.

Loosely woven fabrics and fabrics that stretch easily such as jersey should have an interfacing of a firm fabric. Use cambric or taffeta between woolens and rayons-organdy or lawn between light weight and sheer fabrics.

Use buttonhole scissors or buttonhole cutter to cut buttonhole open.

Always make a practice buttonhole on a piece of the fabric to be used in the garment.

A wider stitch width may be desirable on heavy weight fabrics.

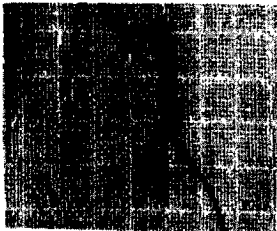
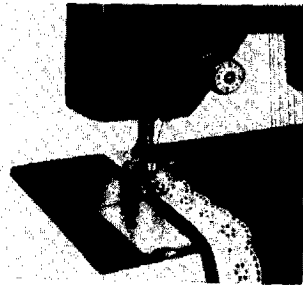
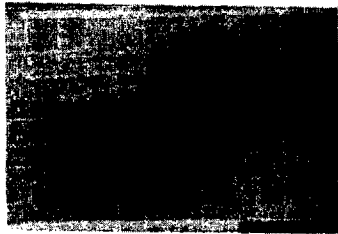

APPLIQUE Use disc #1

Baste cutout applique to fabric. Set stitch width 2 to 4. Set stitch length at the red mark on the indicator plate. Zigzag stitch around applique completely covering the raw edge.

SEWING ON LACE Use disc #1

Set stitch width to 2. Set stitch length to 2 or 3. Place fabric under the presser foot and position lace $\frac{1}{4}$ inch from edge of fabric. Position fabric and lace so that right stitch catches left edge of lace. Continue stitching so that edge of lace is overcast.

STRAIGHT OR THREE-CORNERED TEAR

Use disc #6
Stitch width 4
Stitch length at red mark

Position tear under needle and stitch along the straight tear catching sides of material. When mending a three cornered tear, stitch from each end to center.

OVERCASTING

Use disc # 1

Set stitch width to 4. Set stitch length to about 3. Zigzag stitch around raw edge of fabric to completely cover the edge.

WRITING AND MONOGRAMMING

Use disc # 1

Free hand
Stitch width 0 to 4
Feed dog control Left

Draw initials or words to be sewn on fabric and fit fabric into embroidery hoops. Writing is done with either zigzag or straight stitching. Remove presser foot. Set stitch width for straight or zigzag stitches as desired. Slip hoop and fabric under the needle, lower presser bar and take one stitch to raise bobbin thread through fabric. Using a medium speed, stitch along marked outline, guiding fabric carefully by hands.

SEWING ON STRETCH FABRICS

Use disc # 21

Stitch width 0
Stitch length 4

Use with knitted fabrics and stretch fabrics. Sew as you do straight stitching. Machine will make triple lock stitches back and forth. The seam can be pressed open without breaking thread.

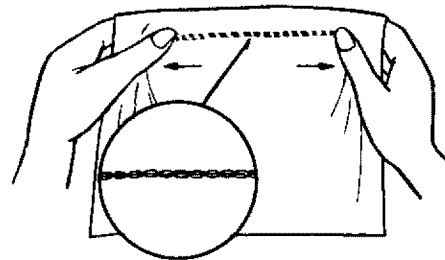
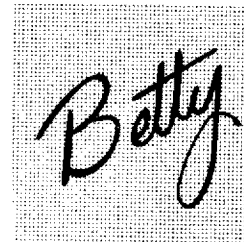
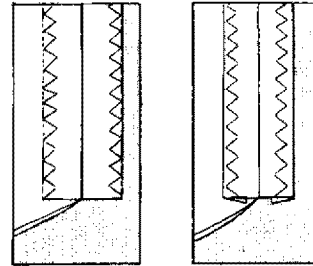

DOUBLE NEEDLE



When using double needle do not set stitch width higher than $2\frac{1}{2}$ setting.

28

1. SETTING THE DOUBLE NEEDLE

Raise the needle bar to its highest position and loosen needle clamp screw. Hold double needle assembly with flat side away from you. Slip the needle as far as it will go into needle clamp, and tighten the screw.

2. THREADING THE DOUBLE NEEDLE

Place a spool of thread on each spool pin. Draw both threads through upper thread guides. Pass a thread between each set of tension discs of the thread tension assembly. Continue threading as you would for single needle sewing except where double thread guides are provided. Draw one thread through each side of the double thread guides and through each needle from front to back. Pull several inches of thread through. Thread bobbin and pick up bobbin thread as for single needle sewing.

3. THREAD SELECTION

Use only mercerized sewing thread size 50 or finer. The same size thread is recommended for both upper and lower threading.

4. STITCHING

All decorative patterns are possible with double needle. Before starting any stitching operation, check needle drop by turning the handwheel manually. Needle should enter fabric without touching presser foot and needle plate. The stitch width control must not be advanced beyond 2½ setting.

5. TURNING A CORNER

To turn a square corner when stitching with a double needle, stop stitching with the longer needle tip just piercing the fabric. Raise the presser foot, shift fabric half the turn, lower presser foot and take one stitch. Raise the presser foot again, complete the turn, and begin stitching in the new direction.

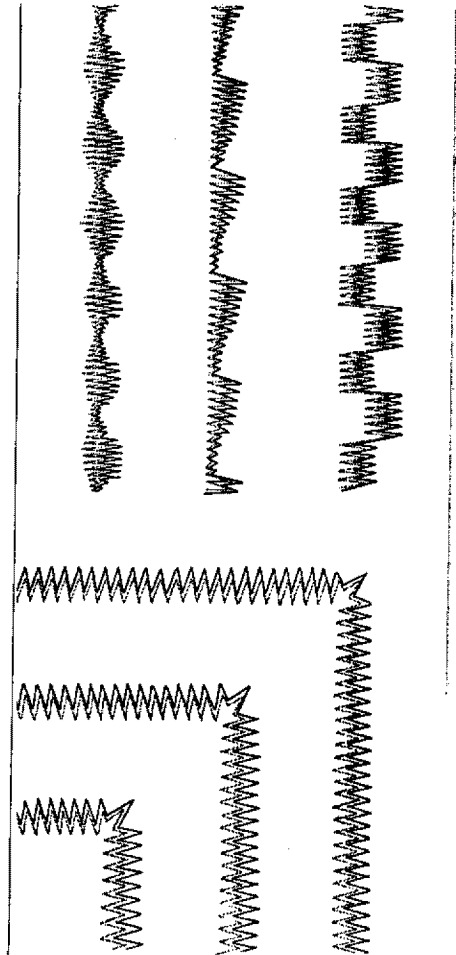

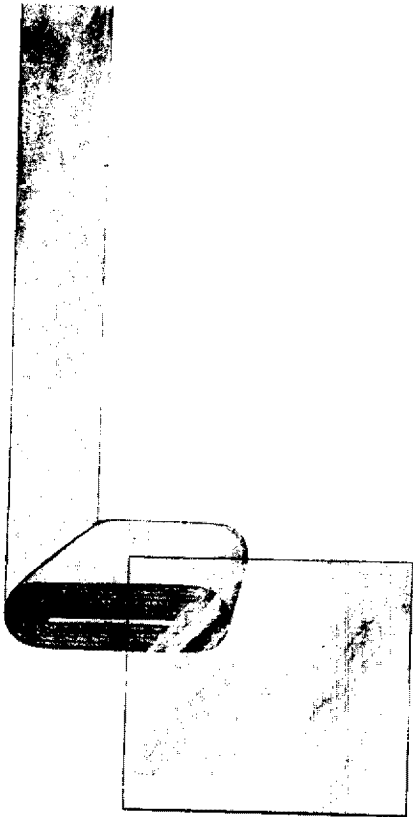

SYNTHETICS

Your KENMORE will sew all the new fabrics of synthetic fiber, such as nylon, *Orlon, **Dacron, rayon, acetate, blends of these, and combinations of synthetic and natural fibers. When stitching a fabric of blended or combined fibers, handle it as you would a material of the fiber present in the largest percentage. For example, a fabric woven of 60% Orlon and 40% silk should be handled as one made entirely of Orlon.

When stitching a fabric that is over 50% synthetic fiber, remember:

- a. Select patterns of the loose fitting type with cap or kimono sleeves, because most synthetic fiber fabrics cannot be eased with steam pressing, and are not absorbent.
- b. Use a synthetic thread.
- c. Use a fine needle as recommended in chart on page 5.
- d. Wind the bobbin in the usual way, but do not pass thread between tension discs. Guide thread by hand for a smoothly wound bobbin.
- e. Choose the stitch length that gives the most satisfactory seam.
- f. Check thread tensions by sewing on a double thickness of the fabric to be used. Usually the upper thread tension must be loosened. Sometimes both bobbin and upper thread tensions must be loosened (pages 12, 13).

SEWING ON PLASTIC FILMS

Set the machine with normal thread tensions and a large size stitch. Use a fine needle and mercerized thread. Hold plastic pieces together with cellophane tape or paper clips rather than pins. Sew corners slightly rounded rather than square.

*Trademark for Dupont's Acrylic fiber. **Trademark for Dupont's polyester fiber.

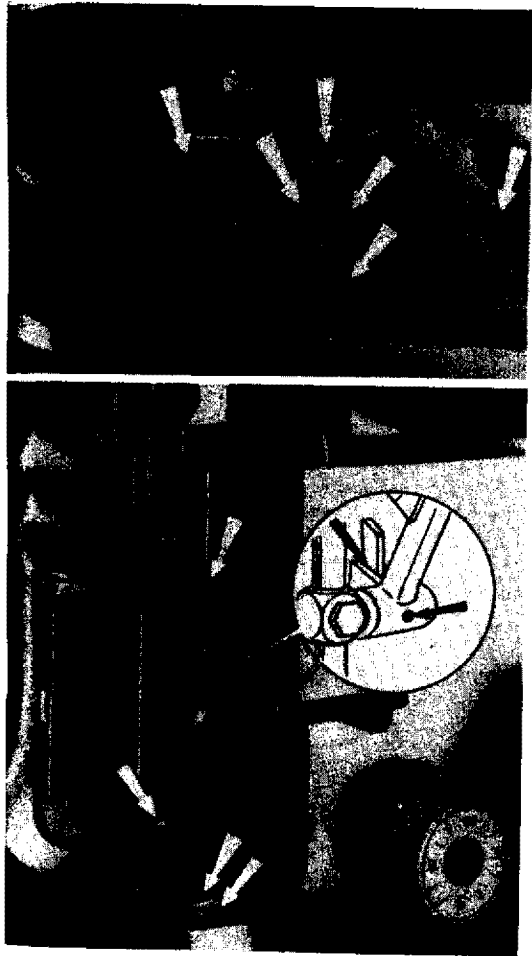

Fig. A

REPLACEMENT OF THE BELT

Push motor against machine and remove belt from motor pulley. Let motor down gently. Pull belt out over hand wheel. Install new belt reversing the above procedure.

CLEANING AND OILING

Keep the moving parts free from dust and thread for quiet and efficient operation. Cleaning should be done with a small brush.

When machine runs hard or makes excessive noise, place a drop of KENMORE sewing machine oil at the points indicated in figs. A, B, & C.

Swing hinged face cover plate open to oil points indicated at end of machine head.

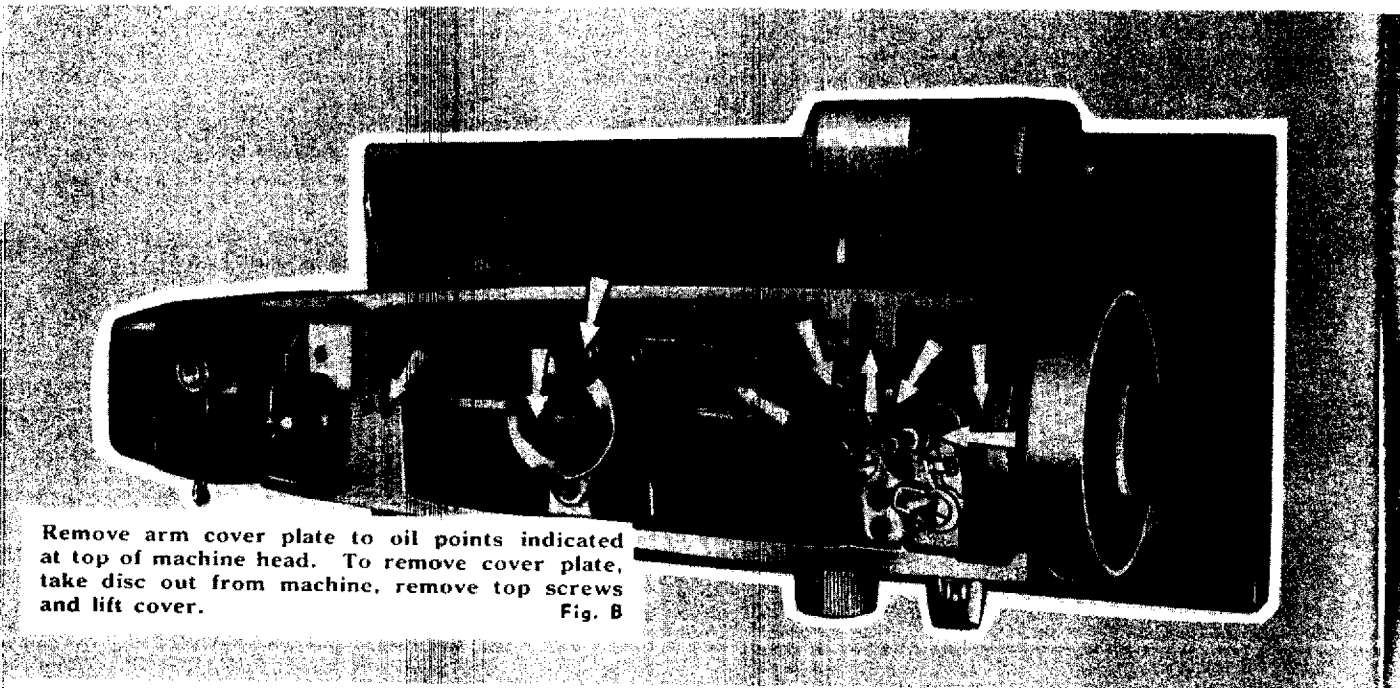

Remove arm cover plate to oil points indicated at top of machine head. To remove cover plate, take disc out from machine, remove top screws and lift cover.
 Fig. B

It may be necessary to clean the shuttle area occasionally.

1. Raise the needle bar to its highest point and remove bobbin case.
2. Push levers sideways from the shuttle assembly and lift shuttle race cover and shuttle out by the center pin.
3. Clean the shuttle race of any lint or small particles of thread with a small brush.
4. Put a drop of oil on the center pin of the shuttle and on shuttle race (see arrows).



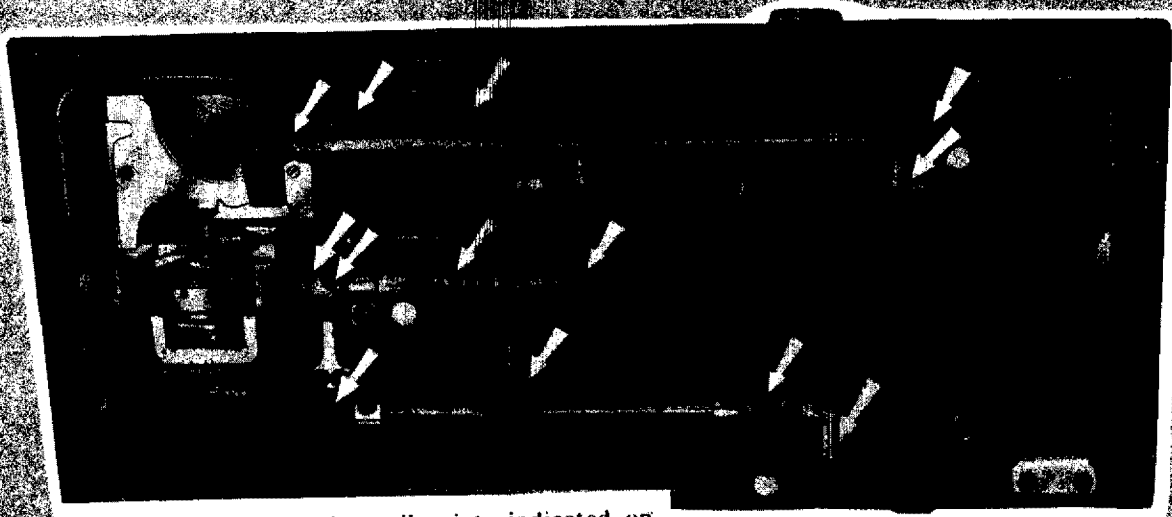

Tilt machine head back to oil points indicated on underside of machine head. Fig. C



Shuttle Race Cover



Shuttle

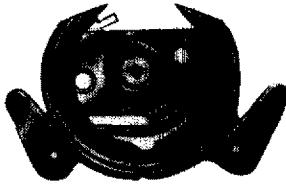

Shuttle Race

To reassemble, hold shuttle by center pin and fit carefully into assembly opposite the shuttle driver. Slip shuttle race cover into place. Snap the levers into position. Occasionally, remove the needle plate and clean feed dog with a soft brush.

WHAT TO DO

PROBLEM	PROBABLE CAUSE	CORRECTION
Irregular Stitches	Incorrect size needle. Improper threading. Loose upper thread tension. Pulling fabric. Light pressure on presser foot. Loose presser foot. Unevenly wound bobbin.	Choose correct size needle for thread and fabric (page 5). Rethread machine (page 9). Tighten upper thread tension (page 12). Do not pull fabric; guide it gently. Increase pressure on presser foot (page 10). Reset presser foot (page 15). Rewind bobbin (page 7).
Breaking Needle	Pulling fabric. Incorrect size needle. Incorrect setting of needle. Loose presser foot.	Do not pull fabric; guide it gently. Choose correct size needle for thread and fabric (page 5). Reset needle (page 5). Reset presser foot (page 15).
Bunching of Thread	Upper and lower threads not drawn back under presser foot. Feed dog down.	Draw both threads back under presser foot (page 10). Raise feed dog (page 15).
Puckering	Incorrect thread tension(s). Light pressure on presser foot. Using two different sizes or kinds of thread. Bent or blunt needle. Loose presser foot. Fabric too sheer or too soft.	Reset thread tension(s) (pages 12, 13). Increase pressure on presser foot (page 10). Upper thread and bobbin thread should be same size and kind. Insert new needle (page 5). Reset presser foot (page 15). Use underlay of tissue paper or tarlatan when stitching.

WHAT TO DO

PROBLEM	PROBABLE CAUSE	CORRECTION
Skipping Stitches	Incorrect size needle. Bent or blunt needle. Incorrect setting of needle. Tight upper thread tension. Light pressure on presser foot.	Choose correct size needle for thread and fabric (page 5). Insert new needle (page 5). Reset needle (page 5). Loosen upper thread tension (page 12). Increase pressure on presser foot (page 10).
Breaking Upper Thread	Starting to stitch too fast. Improper threading. Tight upper thread tension. Incorrect size needle. Sharp eye in needle.	Start to stitch at a medium speed. Rethread machine (page 9). Loosen upper thread tension (page 12). Choose correct size needle for thread and fabric (page 5). Insert new needle (page 5).
Breaking Bobbin Thread	Improper bobbin case threading. Tight bobbin thread tension. Lint in bobbin case or shuttle.	Check bobbin case threading (page 8). Loosen bobbin thread tension (page 13). Clean bobbin case and shuttle (pages 32, 33).
Fabric not Moving	Feed dog down. Light pressure on presser foot. Threads knotted under fabric.	Raise feed dog (page 15). Increase pressure on presser foot (page 10). Place both threads back under presser foot before beginning to stitch.
Machine Jamming (Knocking Noise)	Thread caught in shuttle.	Disassemble and clean shuttle (pages 32, 33).

PARTS LIST

All parts listed here may be ordered through your nearest Sears or Simpsons - Sears retail store, catalog sales office or mail order house.

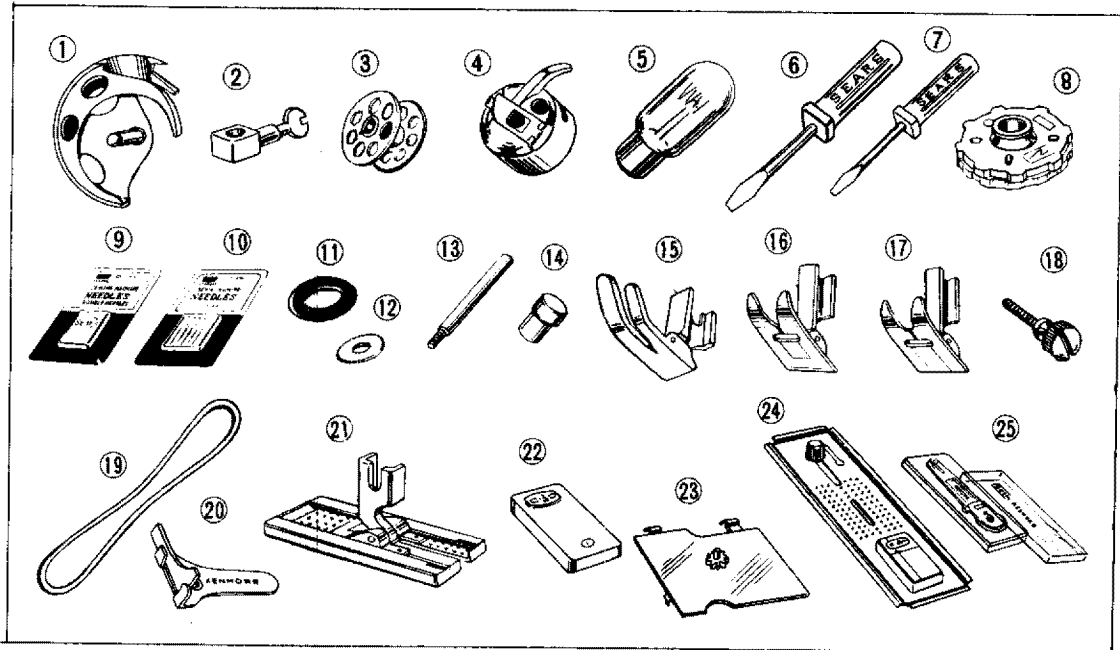

When ordering these parts, please be sure to mention the following references :

1. Model & serial numbers of machine shown on the nomenclature plate. See page 2.
2. Parts number(s) and description(s) here.

When ordering by mail, prices will be furnished on request, or parts will be shipped at prevailing prices and you will be billed accordingly.

Ref. No.	Parts No.	Description	Ref. No.	Parts No.	Description	Ref. No.	Parts No.	Description
1	17980	Shuttle hook	10	6741	No. 11 Single needles in yellow case		9022	1/2" Regular template
2	26929	Needle clamp		6742	No. 14 Single needles in red case		9023	3/8" Regular template
3	6502	Bobbin		6743	No. 16 Single needles in green case		9020	5/8" Keyhole template
4	6510	Bobbin case		6744	No. 18 Single needles in blue case	23	9181	Buttonhole cover plate
5	6797	Light bulb	11	1939	Bobbin winder rubber ring	24	9162	Buttonhole guide plate
6	3015	Large screw driver	12	2273	Nylon disc	25	32736	Buttonhole guide plate
7	3016	Small screw driver	13	8286	Thread spool pin			
8	26841	Pattern disc No. 1	14	1222	Bobbin winder tension disc			
	26842	Pattern disc No. 2	15	740	Straight stitch foot			
	26843	Pattern disc No. 3	16	9363	Zigzag presser foot			
	26844	Pattern disc No. 4	17	6870	Satin stitch foot			
	26845	Pattern disc No. 5	18	135	Presser foot thumb screw			
	26846	Pattern disc No. 6	19	6902	Motor rubber belt			
	26847	Pattern disc No. 7	20	6864	Needle threader			
	26848	Pattern disc No. 8	21	6854	Buttonhole foot			
	26849	Pattern disc No. 9	22	8939	1-1/16" Keyhole template			
	26850	Pattern disc No. 10		8940	1-1/16" Regular template			
	26861	Pattern disc No. 21		8941	13/16" Regular template			
	26862	Pattern disc No. 22		8942	5/8" Regular template			
	26863	Pattern disc No. 23		1293	5/16" Regular template and			
	26864	Pattern disc No. 24			eyelet template			
9	6745	Double needle in ivory case		9021	15/16" Regular template			

ADJUSTING YOUR SEWING MACHINE FOR GOOD STITCHES

When your sewing machine does not sew a properly locked stitch, check the following :

1. Insert a new needle of the correct size for the thread and fabric you are using. Consult chart on page 5 for needle size.
2. The upper and bobbin thread should be matched in size and type.
3. Check threading carefully. See page 9.
4. Check the thread tension balance. Use mercerized thread, and a correct size needle for the fabric you are using. Do not try this test with synthetic thread as it will not break.

Begin with a full bobbin, properly threaded into the case. Set the stitch length at about 12 stitches per inch. Fold a 6" square of your fabric in half diagonally, forming a triangle. Make a line of stitching $\frac{1}{4}$ " from fold.

- a. If seam is puckered - both tensions are too tight.
- b. If the bottom thread lays on the fabric - tighten upper thread tension, and repeat test. See page 12, Figure 3.
- c. If the top thread lays on the fabric - loosen upper thread tension, and repeat test. See page 12, Figure 2.

Grasp the stitching and pull with a snap to make threads break.

- a. If both threads break - tensions are balanced.
- b. If neither thread breaks - both tensions are too loose.
- c. If upper thread breaks - loosen upper tension.
- d. If lower thread breaks - tighten upper tension.

Both threads do not have to break at the same place, but they should break on the same snap.

Bobbin tension may be reset by the following procedure. Start with a loose bobbin thread tension. Tighten the spring screw gradually until bobbin case and full bobbin can be gently lifted from your hand by the end of the bobbin thread.

MEMO

MEMO

SEWING MACHINE

Now that you have purchased your Sewing Machine, should it need repair, call for repair parts or service, simply contact any Sears Service Center and most Sears, Roebuck and Co. or Simpsons-Sears Limited Stores. Be sure to provide all pertinent facts when your call or visit.

The model number of your Sewing Machine will be shown on your nomenclature plate on the front side of bedplate of your Sewing Machine. See page 2 for location.

WHEN ORDERING REPAIR PARTS, ALWAYS GIVE THE FOLLOWING INFORMATION:

*MODEL NUMBER *NAME OF ITEM *PART DESCRIPTION

If the parts you need are not stocked locally, your order will be electronically transmitted to a Sears Repair Parts Distribution Center for handling.

**SEARS, ROEBUCK AND CO., Chicago, IL 60684 U.S.A. and
SIMPSONS-SEARS LIMITED, Toronto, Ontario, Canada**