

# **PCI-1724U**

**14-bit, 32-ch, Isolated Analog  
Output Card**

**User Manual**

## **Copyright**

The documentation and the software included with this product are copyrighted 2006 by Advantech Co., Ltd. All rights are reserved. Advantech Co., Ltd. reserves the right to make improvements in the products described in this manual at any time without notice. No part of this manual may be reproduced, copied, translated or transmitted in any form or by any means without the prior written permission of Advantech Co., Ltd. Information provided in this manual is intended to be accurate and reliable. However, Advantech Co., Ltd. assumes no responsibility for its use, nor for any infringements of the rights of third parties, which may result from its use.

## **Acknowledgements**

PC-LabCard is a trademark of Advantech Co., Ltd. IBM and PC are trademarks of International Business Machines Corporation. MS-DOS, Windows, Microsoft Visual C++ and Visual BASIC are trademarks of Microsoft Corporation. Intel and Pentium are trademarks of Intel Corporation. Delphi and C++ Builder are trademarks of Inprise Corporation.

All other product names or trademarks are properties of their respective owners.

Part No. 2003172400

2nd Edition

Printed in Taiwan

December 2006

## **Product Warranty (2 years)**

Advantech warrants to you, the original purchaser, that each of its products will be free from defects in materials and workmanship for two years from the date of purchase.

This warranty does not apply to any products which have been repaired or altered by persons other than repair personnel authorized by Advantech, or which have been subject to misuse, abuse, accident or improper installation. Advantech assumes no liability under the terms of this warranty as a consequence of such events.

Because of Advantech's high quality-control standards and rigorous testing, most of our customers never need to use our repair service. If an Advantech product is defective, it will be repaired or replaced at no charge during the warranty period. For out-of-warranty repairs, you will be billed according to the cost of replacement materials, service time and freight. Please consult your dealer for more details.

If you think you have a defective product, follow these steps:

1. Collect all the information about the problem encountered. (For example, CPU speed, Advantech products used, other hardware and software used, etc.) Note anything abnormal and list any onscreen messages you get when the problem occurs.
2. Call your dealer and describe the problem. Please have your manual, product, and any helpful information readily available.
3. If your product is diagnosed as defective, obtain an RMA (return merchandise authorization) number from your dealer. This allows us to process your return more quickly.
4. Carefully pack the defective product, a fully-completed Repair and Replacement Order Card and a photocopy proof of purchase date (such as your sales receipt) in a shippable container. A product returned without proof of the purchase date is not eligible for warranty service.
5. Write the RMA number visibly on the outside of the package and ship it prepaid to your dealer.

## **CE**

This product has passed the CE test for environmental specifications when shielded cables are used for external wiring. We recommend the use of shielded cables. This kind of cable is available from Advantech. Please contact your local supplier for ordering information.

## **Technical Support and Assistance**

Step 1. Visit the Advantech web site at **[www.advantech.com/support](http://www.advantech.com/support)** where you can find the latest information about the product.

Step 2. Contact your distributor, sales representative, or Advantech's customer service center for technical support if you need additional assistance. Please have the following information ready before you call:

- Product name and serial number
- Description of your peripheral attachments
- Description of your software (operating system, version, application software, etc.)
- A complete description of the problem
- The exact wording of any error messages

## **Packing List**

Before setting up the system, check that the items listed below are included and in good condition. If any item does not accord with the table, please contact your dealer immediately.

Before you install your PCI-1724U card, please make sure you have the following necessary components:

- 1 x PCI-1724U card
- 1 x Companion CD-ROM (DLL driver included)
- 1 x User Manual (this manual)

# Contents

<b>Chapter 1</b>	<b>Introduction .....</b>	<b>2</b>
1.1	Features .....	2
1.2	Applications .....	3
1.3	Installation Guide .....	4
	Figure 1.1:Installation Flow Chart .....	5
1.4	Software Overview.....	6
1.5	Device Driver Programming Roadmap .....	7
1.6	Accessories.....	9
<b>Chapter 2</b>	<b>Installation .....</b>	<b>12</b>
2.1	Unpacking .....	12
2.2	Driver Installation .....	13
	Figure 2.1:Advantech Automation Software Setup .....	13
	Figure 2.2:Options for Driver Setup .....	14
2.3	Hardware Installation .....	15
	Figure 2.3:Device Name on the Device Manager .....	16
2.4	Device Setup and Configuration .....	17
2.4.1	Setting Up the Device .....	17
	Figure 2.4:Device Manager Dialog Box .....	17
2.4.2	Configuring the Device .....	18
	Figure 2.5:The Device Setting Dialog Box .....	18
	Figure 2.6:Device Name on the List of Devices .....	19
<b>Chapter 3</b>	<b>Signal Connections .....</b>	<b>22</b>
3.1	Overview .....	22
3.2	Switch and Jumper Settings .....	22
	Figure 3.1:Connector, Jumper & Switches .....	22
3.2.1	JP67 .....	23
3.2.2	JP0~JP31 .....	23
3.2.3	Setting the Time to Reset Analog Outputs .....	24
3.2.4	Board ID setting .....	24
3.3	Signal Connections .....	25
3.3.1	Pin Assignment .....	25
	Figure 3.2:I/O Connector Pin Assignments .....	25
3.3.2	I/O Connector Signal Descriptions .....	26
	Table 3.1:I/O Connector Signal Descriptions .....	26
3.3.3	Analog Output Connection .....	26
3.4	Field Wiring Considerations .....	27
<b>Appendix A</b>	<b>Specifications .....</b>	<b>30</b>
A.1	Analog Output .....	30
A.2	General .....	30
<b>Appendix B</b>	<b>Block Diagram .....</b>	<b>32</b>
<b>Appendix C</b>	<b>Register Structure &amp; Format.....</b>	<b>34</b>

C.1	Overview .....	34
	Table C.1:PCI-1724U Register Format (Part 1) .....	34
	Table C.2:PCI-1724U Register Format (Part 2) .....	35
C.2	DAC Control Register-0x00.....	36
	Table C.3:DAC Control Register Trigger .....	36
C.2.1	D13~D0 .....	36
C.2.2	REG1 (D15), REG0 (D14) .....	36
	Table C.4:Register Selection .....	37
	Table C.5:DAC Normal Mode Selection (REG1 = REG0 = 1) 37	
C.2.3	D23~D16 .....	37
	Table C.6:Control Register .....	37
	Table C.7:Group GX Register .....	37
	Table C.8: Channel CX Register .....	38
C.3	Synchronous Output Control Register/DAC Ready Status-0x0439	
	Table C.9:Synchronous Output Control Register/DAC Ready Status Register 39	
C.4	Synchronous Output Trigger Register-0x0C.....	40
	Table C.10:Synchronous Output Trigger Register .....	40
C.5	Board ID-0x10.....	41
	Table C.11:Board ID Register .....	41
	Table C.12:Board ID .....	41

## **Appendix D Calibration .....** **44**

D.1	Voltage Calibration Procedure .....	45
	Figure D.1:Launch the Device Setting .....	45
	Figure D.2:Launch the Calibration .....	46
	Figure D.3:Offset Calibration .....	46
	Figure D.4:Adjustment Process of Offset Calibration .....	47
	Figure D.5:Adjustment Process of Span Calibration .....	48
	Figure D.6:Finish Calibration .....	48
	Figure D.7:Data will be Overwritten .....	49
D.2	Current Calibration Procedure .....	49
	Figure D.8:Launch the Device Setting .....	49
	Figure D.9:Launch the Calibration .....	50
	Figure D.10:Adjustment of Offset Calibration .....	51
	Figure D.11:Adjustment Process of Span Calibration .....	52
	Figure D.12:Check the Analog Output Value .....	52
	Figure D.13:Finish Calibration .....	53
	Figure D.14:Data will be Overwritten .....	53

## Introduction

This chapter gives background information on the PCI-1724U.

Sections include:

- Features
- Applications
- Installation Guide
- Software Overview
- Device Driver Programming Roadmap
- Accessories

# Chapter 1 Introduction

Thank you for buying the Advantech PCI-1724U. The PCI-1724U is an isolated multiple channels analog output card for PCI bus, and each analog output channel is equipped with a 14-bit, double-buffered DAC.

The PCI-1724U is an ideal solution for industrial applications where multiple analog output channels are required.

The following sections of this chapter will provide further information about features of multifunction cards, a Quick Start for installation, together with some brief information on software and accessories for the PCI-1724U card.

## 1.1 Features

---

- 32 isolated analog output channels
- A 14-bit DAC is equipped for each of the analog output channels
- Flexible output range:  $\pm 10$  V, 0 ~ 20 mA, 4 ~ 20 mA  
(0~20mA, 4~20mA is selected by software, please refer to Appendix D Calibration Utility.)
- Synchronized output function
- Output values kept after system hot reset
- Board ID

The Advantech PCI-1724U offers the following main features:

### **Flexible Voltage Output Range**

The PCI-1724U provides a fixed voltage output range of  $\pm 10$  V for a flexible range that can be used for a many different applications. Users can define the specific voltage output range and output data format via the enclosed software utility and driver.



## Keeps Output Values After System Reset

Users can independently set the 32 outputs to different ranges:  $\pm 10$  V, 0 ~ 20 mA or 4 ~ 20 mA, and all ranges are software selectable. When the system is hot reset (power not shut down), the PCI-1724U can either retain the last analog output values, or return to its default configuration, depending on the jumper setting. This practical function eliminates dangers caused by improper operation during unexpected system resets.

## Board ID

The PCI-1724U has a built-in DIP Switch that helps define each card's ID when multiple PCI-1724U cards have been installed on the same PC chassis. The board ID setting function is very useful when users build their system with multiple PCI-1724U cards. With correct Board ID settings, you can easily identify and access each card during hardware configuration and software programming.

*Note: For detailed specifications of the PCI-1724U, please refer to Appendix A, Specifications.*

## 1.2 Applications

---

- Process control
- Programmable voltage source
- Programmable current sink
- Servo control
- Multiple loop PID control

## 1.3 Installation Guide

---

Before you install your PCI-1724U card, please make sure you have the following necessary components:

- PCI-1724U DA&C card
- PCI-1724U User's Manual
- Advantech DLL drivers (Included in the companion CD-ROM)
- Wiring cable PCL-10162 (option)
- Wiring board ADAM-3962 (option)
- Personal computer or workstation with a PCI-bus slot (running Windows 2000/95/ 98/ME/XP)

Some other optional components are also available for enhanced operation such as application software ActiveDAQ, GeniDAQ and other third-party software packages

After you get the necessary components and maybe some of the accessories for enhanced operation of your PCI-1724U multifunction card, you can begin the installation procedure. Figure 1-1 on the next page provides a concise flow chart to give a broad picture of the software and hardware installation procedures:

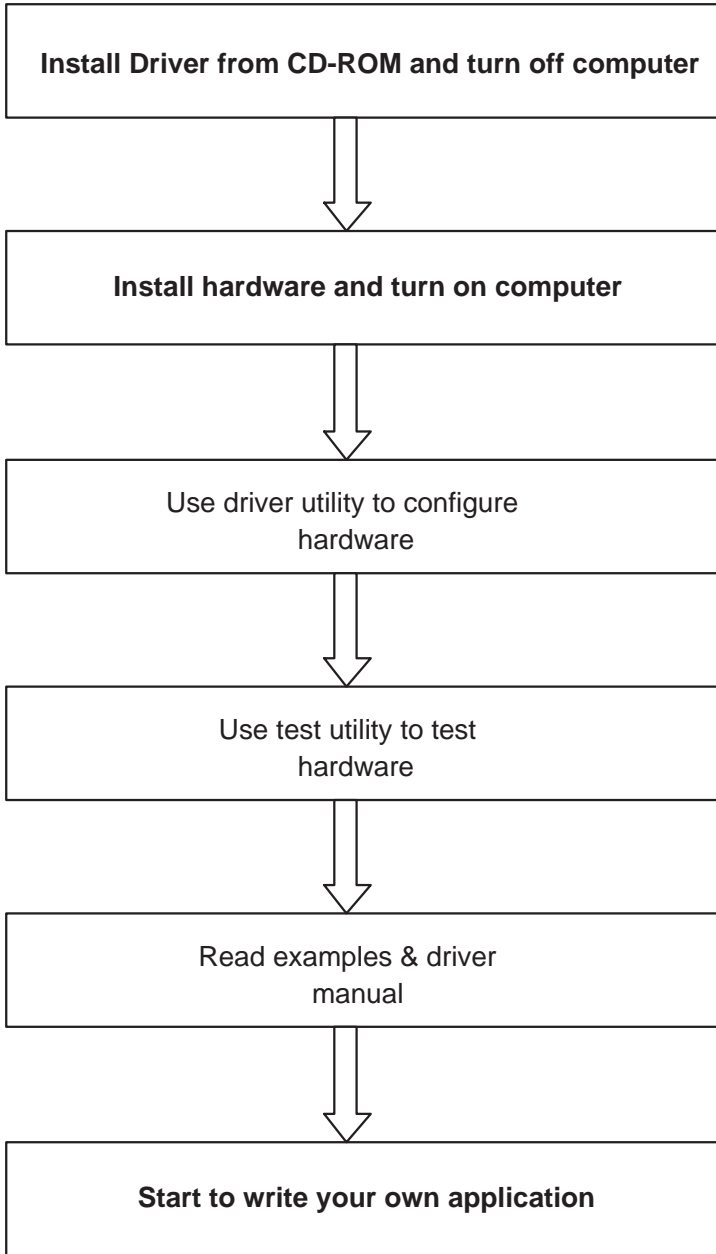

*Figure 1.1: Installation Flow Chart*

## 1.4 Software Overview

---

Advantech offers a rich set of DLL drivers, third-party driver support and application software to help fully exploit the functions of your PCI-1724U card:

- Device Drivers (on the companion CD-ROM)
- LabVIEW driver
- Advantech ActiveDAQ
- Advantech GeniDAQ

Programming choices for DA&C cards: You may use Advantech application software such as Advantech Device Drivers. On the other hand, advanced users are allowed another option for register-level programming, although not recommended due to its laborious and time-consuming nature.

### Device Drivers

The Advantech Device Drivers software is included on the companion CD-ROM at no extra charge. It also comes with all the Advantech DA&C cards. Advantech's Device Drivers features a complete I/O function library to help boost your application performance. The Advantech Device Drivers for Windows 2000/95/98/ME/XP works seamlessly with development tools such as Visual C++, Visual Basic, Inprise C++ Builder and Inprise Delphi.

### Register-Level Programming

Register-level programming is available for experienced programmers who find it necessary to write code directly at the level of the device register. Since register-level programming requires much effort and time, we recommend that you use the Advantech Device Drivers instead. However, if register-level programming is indispensable, you should refer to the relevant information in *Appendix C, Register Structure and Format*, or to the example codes included on the companion CD-ROM.

## 1.5 Device Driver Programming Roadmap

---

This section will provide you a roadmap to demonstrate how to build an application from scratch using Advantech Device Drivers with your favorite development tools such as Visual C++, Visual Basic, Delphi and C++ Builder. The step-by-step instructions on how to build your own applications using each development tool will be given in the *Device Drivers Manual*. Moreover, a rich set of example source code is also given for your reference.

### Programming Tools

Programmers can develop application programs with their favorite development tools:

- Visual C++
- Visual Basic
- Delphi
- C++ Builder

For instructions on how to begin programming works in each development tool, Advantech offers a *Tutorial Chapter* in the *Device Drivers Manual* for your reference. Please refer to the corresponding sections in this chapter on the *Device Drivers Manual* to begin your programming efforts. You can also look at the example source code provided for each programming tool, since they can get you very well oriented.

The *Device Drivers Manual* can be found on the companion CD-ROM. Alternatively, if you have already installed the Device Drivers on your system, The *Device Drivers Manual* can be readily accessed through the Start button:

Start/Programs/Advantech Automation/Device Manager/Device Driver's Manual

The example source code can be found under the corresponding installation folder such as the default installation path:

\\Program Files\\Advantech\\ADSAPI\\Examples

For information about using other function groups or other development tools, please refer to the *Creating Windows 95/NT/2000 Application with Device Drivers* chapter and the *Function Overview* chapter on the *Device Drivers Manual*.

## **Programming with Device Drivers Function Library**

Advantech Device Drivers offer a rich function library that can be utilized in various application programs. This function library consists of numerous APIs that support many development tools, such as Visual C++, Visual Basic, Delphi and C++ Builder.

According to their specific functions or services, the APIs can be categorized into several function groups:

- Analog Output Function Group
- Digital Input/Output Function Group
- Counter Function Group
- Port Function Group (direct I/O)
- Event Function Group

For the usage and parameters of each function, please refer to the *Function Overview* chapter in the *Device Drivers Manual*.

## **Troubleshooting Device Drivers Error**

Driver functions will return a status code when they are called to perform a certain task for the application. When a function returns a code that is not zero, it means the function has failed to perform its designated function. To troubleshoot the Device Drivers error, you can pass the error code to `DRV_GetErrorMessage` function to return the error message. Alternatively, you can refer to the *Device Drivers Error Codes* Appendix in the *Device Drivers Manual* for a detailed listing of Error Codes, Error IDs and the Error Messages.

## 1.6 Accessories

---

Advantech offers a complete set of accessory products to support the PCI-1724U card. These accessories include:

### **Wiring Cable PCL-10162**

The PCL-10162 shielded cable is specially designed for PCI-1724U cards to provide high resistance to noise. To achieve a better signal quality, the signal wires are twisted in such a way as to form a “twisted-pair cable,” reducing cross talk and noise from other signal sources. Furthermore, its analog and digital lines are separately sheathed and shielded to neutralize EMI/EMC problems.

### **Wiring Board ADAM-3962**

The ADAM-3962 is a 62-pin SCSI wiring terminal module for DIN-rail mounting. This terminal module can be readily connected to the Advantech PC-Lab cards and allow easy yet reliable access to individual pin connections for the PCI-1724U card.





## Installation

This chapter gives users a package item checklist, proper instructions for unpacking and step-by-step procedures for both driver and card installation.

Sections include:

- Unpacking
- Driver Installation
- Hardware Installation
- Device Setup and Configuration

# Chapter 2 Installation

## 2.1 Unpacking

---

After receiving your PCI-1724U package, please inspect its contents first. The package should contain the following items:

- PCI-1724U card
- Companion CD-ROM (Device Drivers included)
- User Manual

The PCI-1724U card harbors certain electronic components vulnerable to *electrostatic discharge* (ESD). ESD can easily damage the integrated circuits and certain components if preventive measures are ignored.

Before removing the card from the antistatic plastic bag, you should take the following precautions to ward off possible ESD damage:

- Touch the metal part of your computer chassis with your hand to discharge the static electricity accumulated on your body. Alternatively, one can also use a grounding strap.
- Touch the anti-static bag to a metal part of your computer chassis before opening the bag.
- Take hold of the card only by the metal bracket when removing it out of the bag.

After taking out the card, you should first:

- Inspect the card for any possible signs of external damage (loose or damaged components, etc.). If the card is visibly damaged, please notify our service department or our local sales representative immediately. Do not install a damaged card into your system.

Also, pay extra caution to the following aspects to ensure proper installation:

- Avoid physical contact with materials that could hold static electricity such as plastic, vinyl and Styrofoam.

- Whenever you handle the card, grasp it only by its edges. DO NOT TOUCH the exposed metal pins of the connector or the electronic components.

*Note: Keep the anti-static bag for future use. You might need the original bag to store the card if you have to remove the card from PC or transport it elsewhere.*

## 2.2 Driver Installation

---

We recommend you to install the driver before you install the PCI-1724U card into your system, since this will guarantee a smooth installation process.

The Advantech Device Drivers Setup program for the PCI-1724U card is included in the companion CD-ROM that is shipped with your DA&C card package. Please follow the steps below to install the driver software:

Step 1: Insert the companion CD-ROM into your CD-ROM drive.

Step 2: The Setup program will be launched automatically if you have the autoplay function enabled on your system. When the Setup Program is launched, you will see the following Setup Screen.

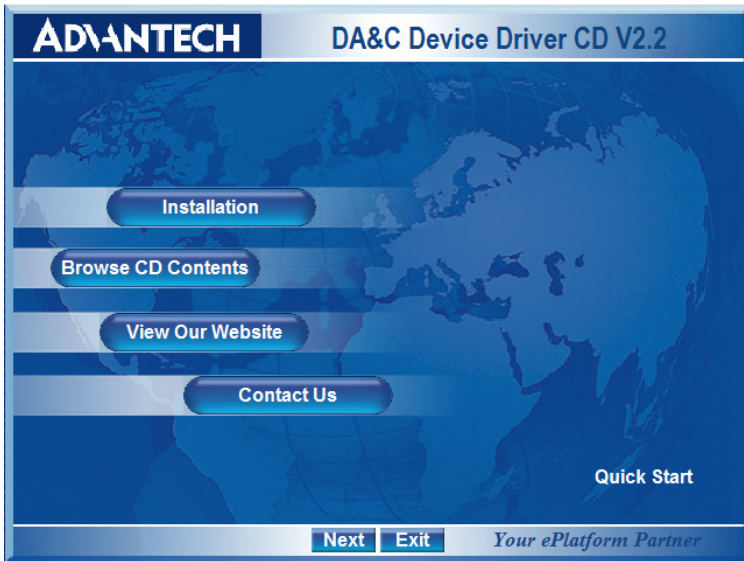
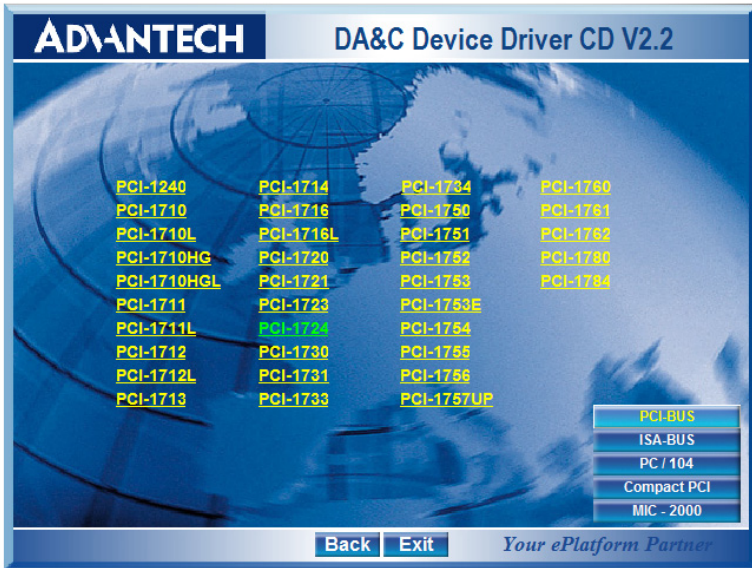

**Figure 2.1: Advantech Automation Software Setup**

**Note:** If the autoplay function is not enabled on your computer, use Windows Explorer or Windows Run command to execute *SETUP.EXE* on the companion CD-ROM.

Step 3: Select the *Individual Driver* option.

Step 4: Select the specific device then just follow the installation instructions step by step to complete your device driver installation and setup.



**Figure 2.2: Options for Driver Setup**

For further information on driver-related issues, an online version of the *Device Drivers Manual* is available by accessing the following path:

Start/Programs/Advantech Automation/Device Manager/Device Driver's Manual

## 2.3 Hardware Installation

---

Make sure you have installed the driver first before you install the card (please refer to *2.2 Driver Installation*).

After the Device Drivers installation is completed, you can then install the PCI-1724U card into any PCI slot on your computer. However, it is suggested that you refer to the computer user's manual or related documentation if you have any doubt. Please follow the steps below to install the card onto your system.

1. Turn off your computer and unplug the power cord and cables. TURN OFF your computer before installing or removing any components on the computer.
2. Remove the cover of your computer.
3. Remove the slot cover on the back panel of your computer.
4. Touch the metal part on the surface of your computer to neutralize the static electricity that might be on your body.
5. Insert the PCI-1724U card into a PCI slot. Hold the card only by its edges and carefully align it with the slot. Insert the card firmly into place. Use of excessive force must be avoided; otherwise, the card might be damaged.
6. Fasten the bracket of the PCI card on the back panel rail of the computer with screws.
7. Connect appropriate accessories (62-pin cable, wiring terminals, etc. if necessary) to the PCI card.
8. Replace the cover of your computer chassis. Re-connect the cables you removed in step 2.
9. Plug in the power cord and turn on the computer.

**Note:** *In case you installed the card without installing the Device Drivers first, Windows 95/98/ME will recognize your card as an "unknown device" after rebooting, and will prompt you to provide the necessary driver. You should ignore the prompting messages (just click the Cancel button) and set up the driver according to the steps described in 2.2 Driver Installation.*

After the PCI-1724U card is installed, you can verify whether it is properly installed on your system in the *Device Manager*:

1. Access the *Device Manager* through *Control Panel/System/Device Manager*.
2. The *device name* of the PCI-1724U should be listed on the *Device Manager* tab on the *System Property Page*.

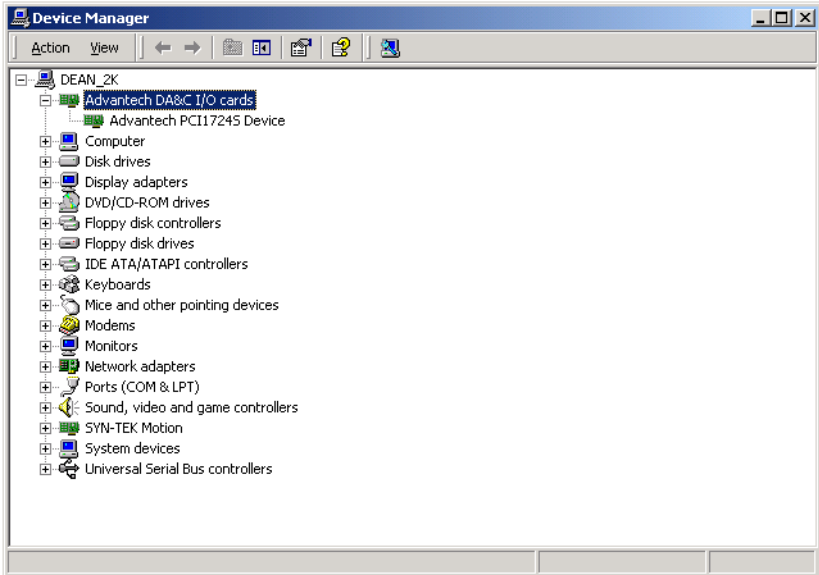

**Figure 2.3: Device Name on the Device Manager**

If your card is properly installed, you should see the device name of your card listed on the Device Manager tab. If you do see your device name listed on it but marked with an exclamation sign “!”, it means your card has not been correctly installed. In this case, remove the card device from the Device Manager by selecting its device name and press the Remove button. Then go through the driver installation process again.

After your card is properly installed on your system, you can now configure your device using the *Advantech Device Manager* Program that has itself already been installed on your system during driver setup. A complete device installation procedure should include *device setup*, *configuration* and *testing*. The following sections will guide you through the Setup, Configuration and Testing of your device.

## 2.4 Device Setup and Configuration

---

The *Advantech Device Manager* program is a utility that allows you to set up, configure and test your device, and later stores your settings on the system registry. These settings will be used when you call the APIs of Advantech Device Drivers.

### 2.4.1 Setting Up the Device

1. To install the I/O device for your card, you must first run the *Device Installation* program (by accessing *Start/Programs/ Advantech Automation/Device Manager*).
2. You can then view the device(s) already installed on your system (if any) on the Installed Devices list box.

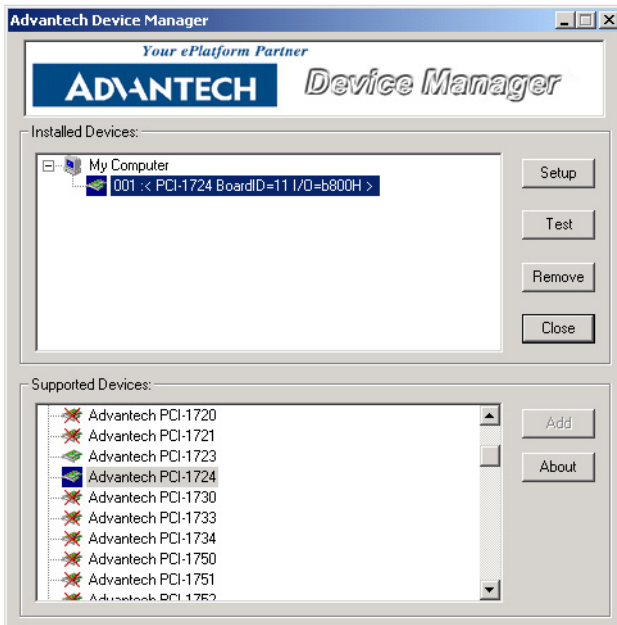

**Figure 2.4: Device Manager Dialog Box**

## 2.4.2 Configuring the Device

3. In the Device Setting dialog box (Fig.2-5), you can calibrate the voltage output range for the 8 D/A channels in 4 groups. For more detailed information, please refer to Appendix D Calibration Utility.

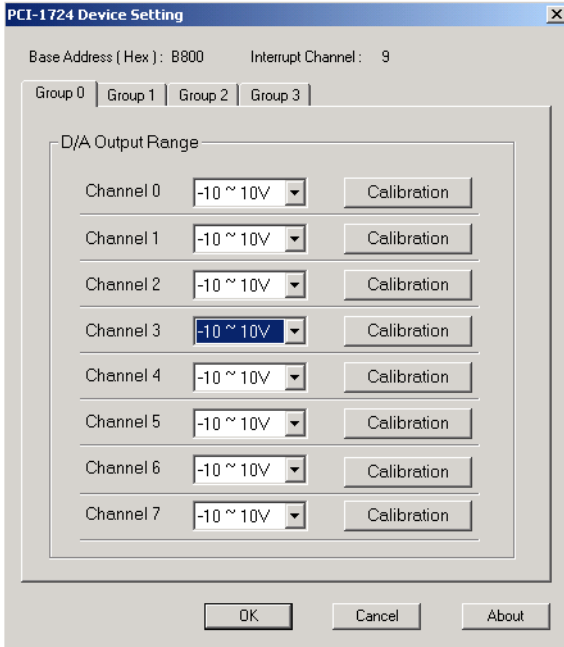
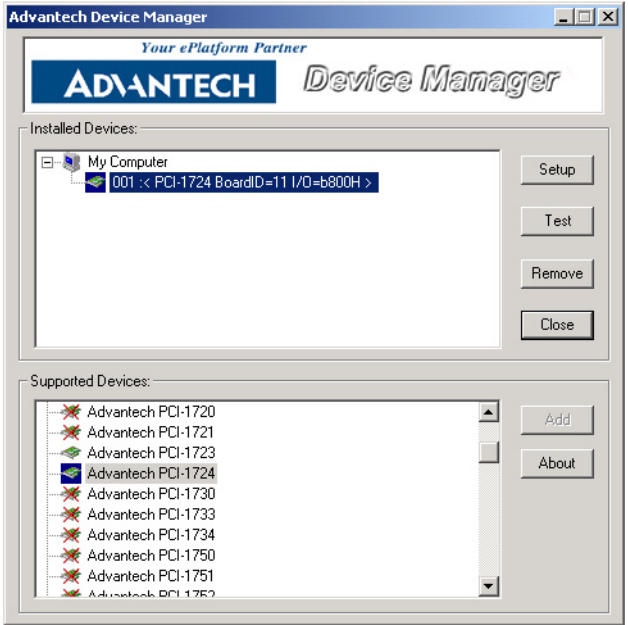

**Figure 2.5: The Device Setting Dialog Box**

**Note:** Users have three options for the output voltage ranges and current ranges:  $-10 \sim 10$  V,  $0 \sim 20$  mA and  $4 \sim 20$  mA.



4. After you have finished configuring the device, click OK and the device name will appear in the Installed Devices box as seen below:



**Figure 2.6: Device Name on the List of Devices**

After your card is properly installed and configured, you can click the **Test...** button to test your hardware by using the testing utility supplied. For more detailed information, please refer to Chapter 2 of the Device Drivers Manual.

You can also find the rich examples on the CD-ROM to speed up your programming.



## Signal Connections

This chapter provides advise on settings and connections for PCI-1724U.

Sections include:

- Overview
- Switch and Jumper Settings
- Signal Connections
- Field Wiring Considerations

# Chapter 3 Signal Connections

## 3.1 Overview

---

Maintaining signal connections is one of the most important factors in ensuring that your application system is sending and receiving data correctly. A good signal connection can avoid unnecessary and costly damage to your PC and other hardware devices. This chapter provides useful information about how to connect input and output signals to the PCI-1724U via the I/O connector.

## 3.2 Switch and Jumper Settings

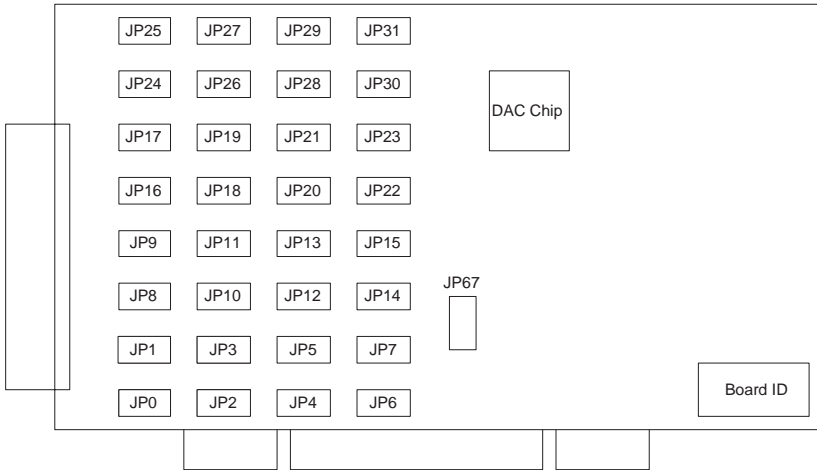

---

The PCI-1724U card has one Board ID switch and 33 jumper settings..

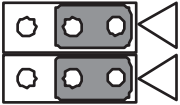
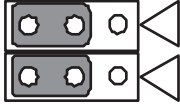

**Figure 3.1: Connector, Jumper & Switches**

### 3.2.1 JP67

	Keep last status after hot reset.
	Default configuration.

### 3.2.2 JP0~JP31

	Current
	Voltage

### 3.2.3 Setting the Time to Reset Analog Outputs

Some users will want the capability of clearing each analog output when the system (or PC) issues a reset signal on the PCI bus. Some users will want to clear their analog output only as part of system power-on.

The PCI-1724U satisfies both these needs by providing jumper JP67. Depending on the application, this capability may allow analog outputs to be "ZERO" without requiring a complete shutdown of processes controlled by the card.

Complete loss of power to the chip clears the chip memory. Thus, no matter how JP1 is set, if the power to the PCI-1724U is disconnected, the analog output initial power-on state will be "ZERO".

### 3.2.4 Board ID setting

ID3	ID2	ID1	ID0	Board ID
1	1	1	1	0
1	1	1	0	1
1	1	0	1	2
1	1	0	0	3
1	0	1	1	4
1	0	1	0	5
1	0	0	1	6
1	0	0	0	7
0	1	1	1	8
0	1	1	0	9
0	1	0	1	10
0	1	0	0	11
0	0	1	1	12
0	0	1	0	13
0	0	0	1	14
0	0	0	0	15

Note: On: 1, Off: 0

### 3.3 Signal Connections

#### 3.3.1 Pin Assignment

Figure 3-2 shows the pin assignments for the 62-pin I/O connector on the PCI-1724U.

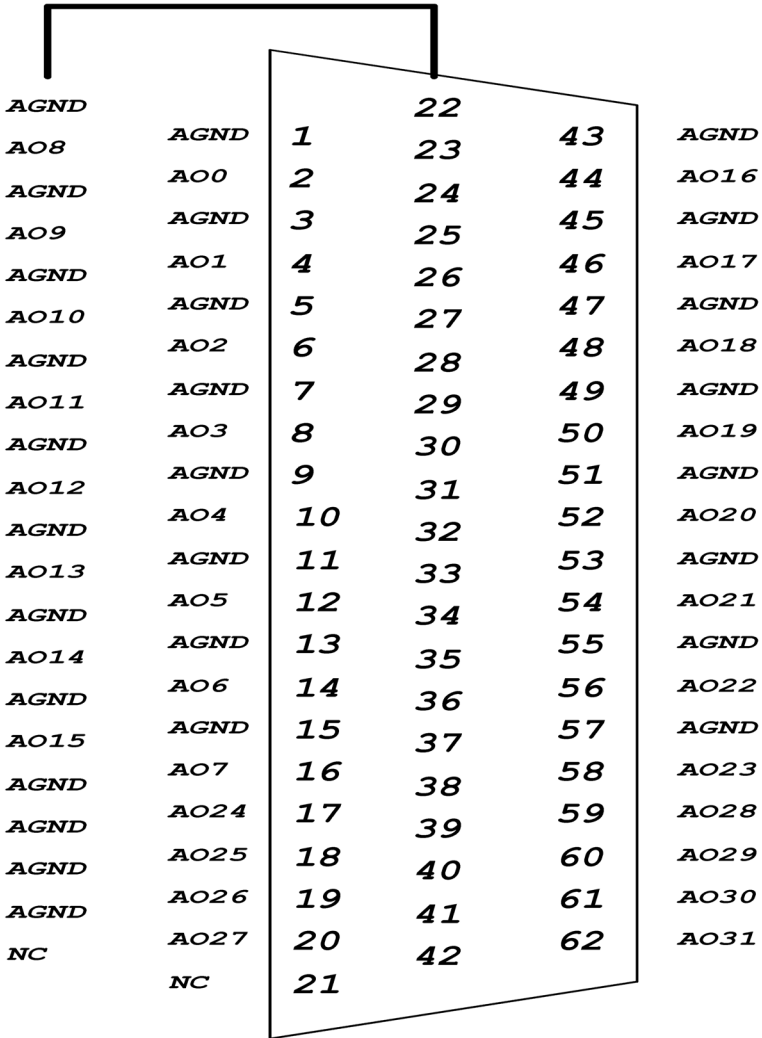

Figure 3.2: I/O Connector Pin Assignments

### 3.3.2 I/O Connector Signal Descriptions

**Table 3.1: I/O Connector Signal Descriptions**

Signal	Reference	Direction	Description
Vout<0~31>	AGND	Output	Voltage Output, Channel 0 through 31
Iin<0~31>	AGND	Input(Sink)	Current Input, Channel 0 through 32
AGND	-	-	Analog Ground. The two ground references (AGND and DGND) are connected together on the PCI-1724U card.

### 3.3.3 Analog Output Connection

The PCI-1724U provides 32 D/A output channels, AO0~AO31. You may use the PCI-1724U's internally provided precision reference to generate a -10 V to +10 V D/A output range.



### 3.4 Field Wiring Considerations

---

When you use the PCI-1724U to acquire data from outside, noises in the environment might significantly affect the accuracy of your measurements if due cautions are not taken. The following measures will be helpful to reduce possible interference running signal wires between signal sources and the PCI-1724U.

The signal cables must be kept away from strong electromagnetic sources such as power lines, large electric motors, circuit breakers or welding machines, since they may cause strong electromagnetic interference. Keep the analog signal cables away from any video monitor, since it can significantly affect a data acquisition system.

If the cable travels through an area with significant electromagnetic interference, you should adopt individually shielded, twisted-pair wires as the analog input cable. This type of cable has its signal wires twisted together and shielded with a metal mesh. The metal mesh should only be connected to one point at the signal source ground.

Avoid running the signal cables through any conduit that might have power lines in it.

If you have to place your signal cable parallel to a power line that has a high voltage or high current running through it, try to keep a safe distance between them. Alternatively, you can place the signal cable at a right angle to the power line to minimize the undesirable effect.

The signals transmitted on the cable will be directly affected by the quality of the cable. In order to ensure better signal quality, we recommend that you use the PCL-10162 shielded cable.



# APPENDIX A

## Specifications

This appendix provides information on the specifications of PCI-1724U.

Sections include:

- Analog Output
- General

# Appendix A Specifications

## A.1 Analog Output

---

<b>Channels</b>	32-CH Isolation	
<b>Resolution</b>	14-bit	
<b>Operation Mode</b>	Single output, Synchronized output	
<b>Output Range (Internal Reference only)</b>	-10~+10V, 0~20mA, 4~20mA (0~20mA, 4~20mA is selected by software, please refer to Appendix D Calibration Utility.)	
<b>Driving Capacity</b>	+/-10mA	
<b>Accuracy</b>	Relative	+/- 4 LSB
	Differential Non-linearity	+/- 2 LSB (monotonic)
<b>Offset</b>	< 2 LSB	
<b>Output Impedance</b>	0.1 W max.	
<b>Throughput</b>	PC dependent, Software update (Direct AO)	
<b>Settling Time</b>	60 $\mu$ s	
<b>Isolation</b>	1,500 VDC system isolation	

## A.2 General

---

<b>I/O Connector Type</b>	One DB-62 connector
<b>Dimensions (L x H)</b>	175 x 100 mm (6.9" x 3.9")
<b>Operating Temperature</b>	0 ~ 60° C (32 ~ 140° F) (refer to IEC 68-2-1, 2)
<b>Storage Temperature</b>	-20 ~ 70° C (-4 ~ 158° F)
<b>Operating Humidity</b>	5 ~ 95 % RH non-condensing (refer to IEC 68-2-3)

# APPENDIX **B**

## **Block Diagram**

This appendix shows the block diagram for PCI-1724U.

# Appendix B Block Diagram

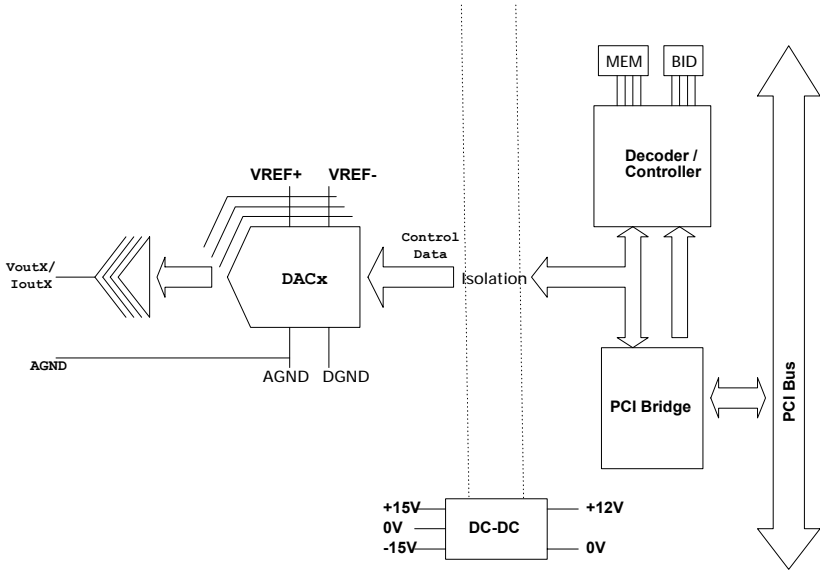

## **Register Structure & Format**

This chapter provides information on the register structure and format for PCI-1724U.

Sections include:

- Overview

# Appendix C Register Structure & Format

## C.1 Overview

The PCI-1724U is delivered with an easy-to-use 32-bit device driver for user programming under the Windows 2000/95/98/ME/XP operating systems. We advise users to program the PCI-1724U using the 32-bit device drivers provided by Advantech to avoid the complexity of low-level registry programming.

The most important consideration in programming the PCI-1724U at register level is to understand the function of the card's registers. The information in the following sections is provided only for users who would like to do their own low-level programming.

Table C-1 and C-2 shows the function of each register for PCI-1724U or its driver and its address relative to the card's Offset Address.

<b>Table C.1: PCI-1724U Register Format (Part 1)</b>					
<b>Offset Address (HEX)</b>		<b>PCI-1724U Register Format</b>			
		D31~D24	D23~D16	D15	D14
<b>0x00</b>	W	<b>DAC Control Register Trigger</b>			
		N/A	Group/Channel Select Bit	REG1	REG0
	R	N/A			



**Table C.2: PCI-1724U Register Format (Part 2)**

Offset Address (HEX)		PCI-1724U Register Format						
		D31~D6	D5	D4	D3	D2	D1	D0
0x04	W	<b>Synchronous Output Control Mode</b>						
		X	X	X	X	X	X	SYN
	R	<b>Synchronous Output Control Status</b>						
		X	X	X	X	X	DACSTAT	SYN
0x10	W	<b>N/A</b>						
	R	<b>Board ID</b>						
		X	X	X	BD3	BD2	BD1	BD0
0x0C	W	<b>SYNOUT Trigger(It Works Only When SYNOUT Register Is Set)</b>						
		X	X	X	X	X	X	X
	R	<b>N/A</b>						

## C.2 DAC Control Register-0x00

PCI-1724U is designed for a 32-bit bus and will read all 32 bits at the same time. Because the card can be addressed individually, knowing how the PCI-1724U's register works becomes a very important issue. There are several channel groupings which enable you to simultaneously write the same data to multiple DAC channels. Table C-3 shows the format of the DAC control register.

**Table C.3: DAC Control Register Trigger**

Offset Address (HEX)		PCI-1724U Register Format				
		D31~D24	D23~D16	D15	D14	D13~D0
0x00	W	DAC Control Register				
		N/A	Group/Channel Select Bit	REG1	REG0	DAC Data Code
	R	N/A				

### C.2.1 D13~D0

PCI-1724U accepts a straight 14-bit parallel word on D13~D0 where D13 is the MSB and D0 is the LSB. See Table C-3.

### C.2.2 REG1 (D15), REG0 (D14)

REG1 and REG0 determine the destination register of the data being written to the PCI-1724U. This register provides three main categories: normal mode, offset mode, gain mode.

If users do not want to change the setting status of calibration, select the Normal Mode (REG1=1, REG0=1). If users want to calibrate in this register, we also provide Offset Mode and Gain Mode which allow users to calibrate through adjusting the value of REG1 and REG0. See Table C-4, C-5.

**Warning!** *We strongly recommend that you use the calibration utility provided in the CD-ROM to calibrate this card instead of adjusting it directly in registers. Adjusting REG1 and REG0 can result in some unexpected problems due to the wrong settings.*

**Table C.4: Register Selection**

REG1	REG0	Register Selected
1	1	Normal Mode(Recommended)
1	0	Offset Mode(Used in calibration)
0	1	Gain Mode(Used in calibration)
0	0	N/A

**Table C.5: DAC Normal Mode Selection (REG1 = REG0 = 1)**

D23~D20	D19~D16	D15	D14	D13~D0
GX	CX	1	1	DATA

### C.2.3 D23~D16

Address bits D23~D20 are decoded to select on group or multiple groups of registers.

Address bits D19~D16 select the channels. See Table C-6, C-7, C-8.

**Table C.6: Control Register**

D23~D20	D19~D16	D15	D14	D13~D0
Group Select Bit (GX)	Channel select Bit (CX)	REG1	REG0	DAC Data Code

**Table C.7: Group GX Register**

Group GX	D23	D22	D21	D20
GX=1	0	0	0	1
GX=2	0	0	1	0
GX=3	0	1	0	0
GX=4	1	0	0	0

**Table C.8: Channel CX Register**

Channel CX	D19	D18	D17	D16
CX=0	0	0	0	0
CX=1	0	0	0	1
CX=2	0	0	1	0
CX=3	0	0	1	1
CX=4	0	1	0	0
CX=5	0	1	0	1
CX=6	0	1	1	0
CX=7	0	1	1	1

**Note**      *Mapping AOx = (Group GX-1) \* 8 + Channel CX*  
*x=0~31 (GX=1~4; CX=0~7).*

### C.3 Synchronous Output Control Register/DAC Ready Status-0x04

The PCI-1724U provides an innovate function in which all D/A channels can output their data in synchronization. It is necessary to verify DAC-STAT status every time you want to output DAC data, otherwise the command results in errors.

**Table C.9: Synchronous Output Control Register/DAC Ready Status Register**

Offset Address (HEX)		PCI-1724U Register Format						
		D31~D6	D5	D4	D3	D2	D1	D0
0x04	W	<b>Synchronous Output Control Mode</b>						
		X	X	X	X	X	X	SYN
	R	<b>Synchronous Output Control Status</b>						
		X	X	X	X	X	DACSTAT	SYN

SYN:

‘0’ Indicate DAC Is Direct Output Mode

‘1’ Indicate DAC Is Synchronous Output Mode

DACSTAT:

‘0’ Indicate DAC State Machine Is Ready For Next DAC Data

‘1’ Indicate DAC State Machine Is Busy

## C.4 Synchronous Output Trigger Register-0x0C

Write any value to 0x0C to synchronize all D/A channels. You can write only one channel, or several channels.

<b>Table C.10: Synchronous Output Trigger Register</b>							
<b>Offset Address (HEX)</b>		<b>PCI-1724U Register Format</b>					
		D31~D6	D5	D4	D3	D2	D1
<b>0x0C</b>	W	<b>SYNOUT Trigger</b>					
		X	X	X	X	X	X
	R	<b>N/A</b>					

**Note**     *Synchronous Mode: Be sure to enable the synchronize function by writing the value to Offset Address=0x04 first. Second, write the specific data into Offset Address=0x00. Lastly, write any value to Offset Address=0x0C to synchronize all D/A channels.*

*Direct Output Mode: If you did not enable the synchronize function by writing the value to Offset Address=0x04 first, all the specific data which was written to Offset Address=0x00 will be output immediately!*

## C.5 Board ID-0x10

The PCI-1724U offers Board ID register Offset Address=0x10. With correct Board ID settings, you can easily identify and access each card during hardware configuration and software programming.

**Table C.11: Board ID Register**

Offset Address (HEX)		PCI-1724U Register Format						
		D31~D6	D5	D4	D3	D2	D1	D0
0x10	W	N/A						
	R	Board ID						
		X	X	X	BD3	BD2	BD1	BD0

**Table C.12: Board ID**

BD3	BD2	BD1	BD0	Board ID
1	1	1	1	15
1	1	1	0	14
1	1	0	1	13
1	1	0	0	12
1	0	1	1	11
1	0	1	0	10
1	0	0	1	9
1	0	0	0	8
0	1	1	1	7
0	1	1	0	6
0	1	0	1	5
0	1	0	0	4
0	0	1	1	3
0	0	1	0	2
0	0	0	1	1
0	0	0	0	0

**Note**           BD0   LSB of the Board ID  
                   BD3   MSB of the Board ID.





# APPENDIX D

## **Calibration**

This chapter offers a brief guide to the calibration procedure.

# Appendix D Calibration

The PCI-1724U has been well calibrated at the factory, so it is normally not necessary to calibrate the PCI-1724U for initial use. However, if some special conditions have to be met, calibrate the PCI-1724U by the procedure shown below.

To perform an effective calibration, a standard 4-1/2 digits resolution measurement meter has to be used.

There are 2 calibration procedures in PCI-1724U. Which procedure to use depends on what range that is selected:

- Voltage Calibration ( -10 V ~ 10 V)
- Current Calibration ( 0~20 mA, 4~20 mA)

## D.1 Voltage Calibration Procedure

---

1. Click the Setup button on the Advantech Device Manager window (Fig.1) to launch the PCI-1724U Device Setting window (Fig.2).

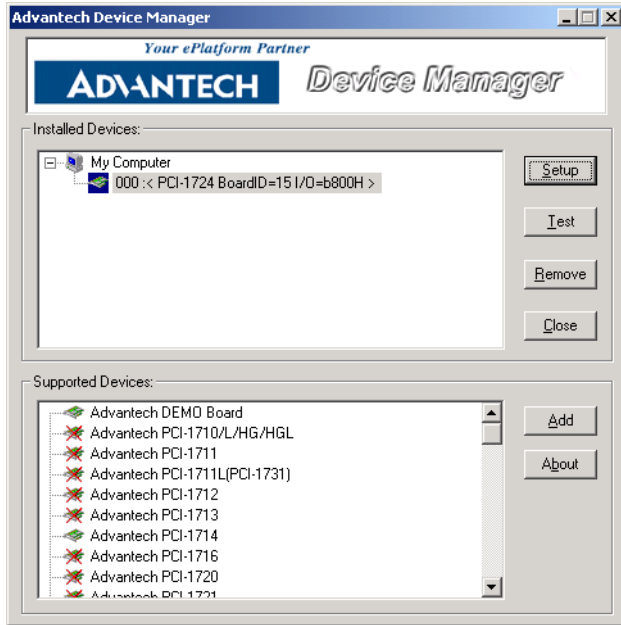

**Figure D.1: Launch the Device Setting**

2. Select the output range of the channel to  $-10V\sim 10V$ .
3. Click the **Calibration** button to start the calibration process. The Calibration Wizard window will pop up.

**Note**      *Each calibration process can calibrate only one channel and one input range at a time.*

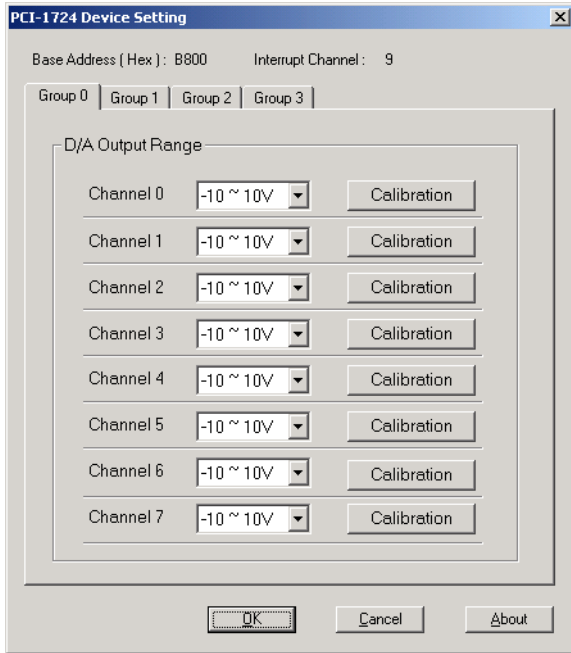

**Figure D.2: Launch the Calibration**

4. Follow the instruction of **Calibration Wizard** and click the **Next** button to proceed to the next step.



**Figure D.3: Offset Calibration**

5. At this step, the Wizard will output  $-10\text{V}$  on the channel you selected. Please check the value on the meter is in the range (I). If the value does not fit, please perform the adjustment. There are 3 ways to perform the adjustment.

1. Move the slider (II).

2. Input the adjust value (III). Note that only if the [Set] button is pressed, the value will take effect.

3. Press [Default] button (IV). This will load the factory default value.

The value on the meter will change after you modify the Adjust Value. Please check the value on the meter is in the range again. If value fits the condition, press the [Next] button to continue.

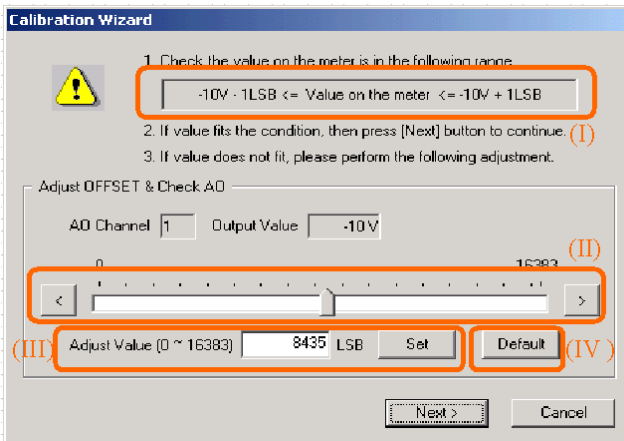

**Figure D.4: Adjustment Process of Offset Calibration**

- This step is to adjust Span. The Wizard will output +10 V on the channel you selected. The steps of span calibration are quite similar to those of the offset calibration (Step 5). Follow the instructions of the *Calibration Wizard*. If value fits the condition, press the [Next] button to continue.

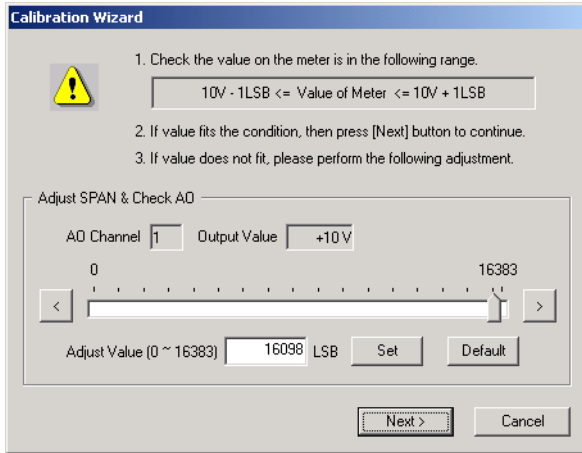

**Figure D.5: Adjustment Process of Span Calibration**

**Step 7:** After span calibration, you have successfully calibrated your PCI-1724U device. Please press [Finish] to finish it.

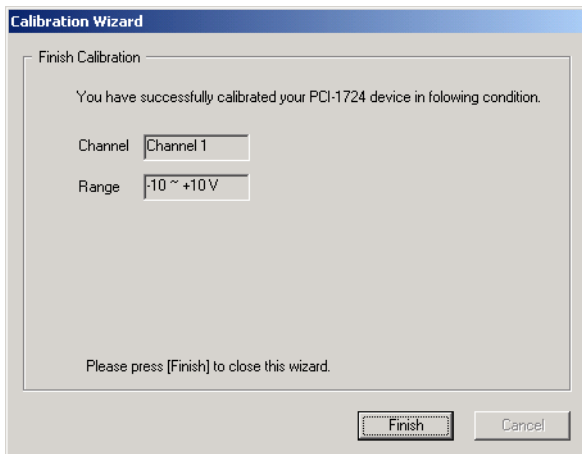

**Figure D.6: Finish Calibration**

**Step 8:** The wizard will pop up a dialog to inform you that the current calibration data of this channel will be overwritten, if you click [Yes] button. Otherwise click [No] to give up the data.

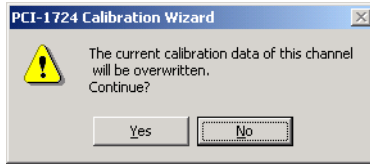
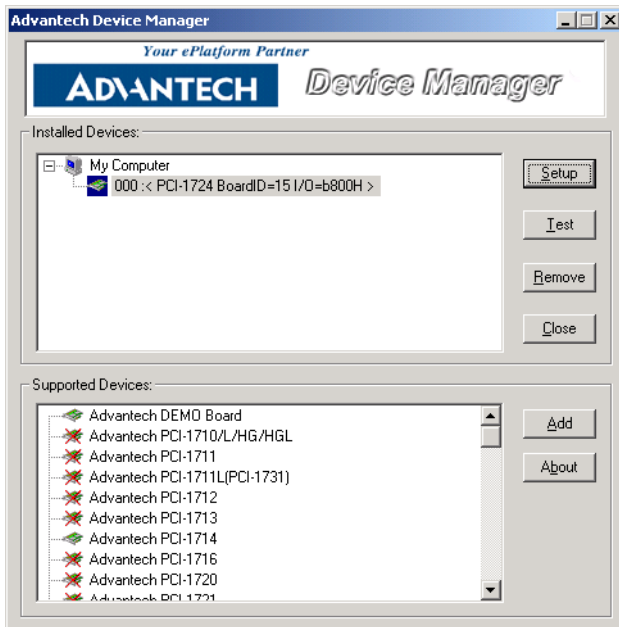

*Figure D.7: Data will be Overwritten*

## D.2 Current Calibration Procedure

---

**Step 1:** Click the Setup button on the Advantech Device Manager window (Fig.1) to launch the PCI-1724U Device Setting window (Fig.2).

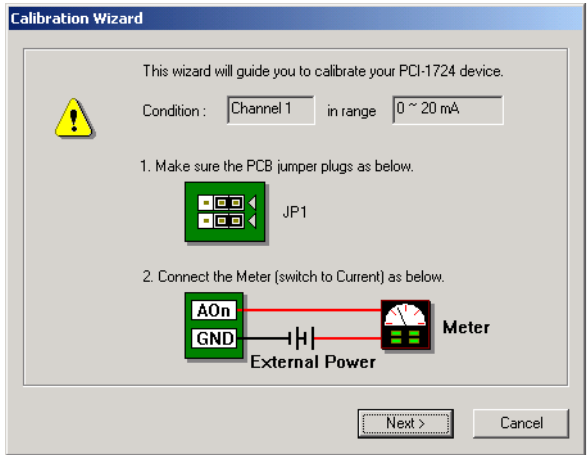

*Figure D.8: Launch the Device Setting*

**Step 2:** Select the output range of the channel to 0~20mA or 4~20mA.

**Step 3:** Click the **Calibration** button to start the calibration process. The Calibration Wizard window will pop up.

<i>Note</i>	<i>Each calibration process can calibrate only one channel and one input range at a time.</i>
-------------	---



**Figure D.9: Launch the Calibration**

**Step 4:** Follow the instruction of *Calibration Wizard* and click the *Next* button to proceed to the next step.

Fig.3 The start-up window of offset calibration

**Step 5:** At this step, the Wizard will output 4 mA on the channel you selected. Please check the value on the meter is in the range (I). If the value does not fit, please perform the adjustment.

There are 3 ways to perform the adjustment.

1. Move the slider (II).
2. Input the adjust value (III). Note that only if the [Set] button is pressed, the value will take effect.



3. Press [Default] button (IV). This action will load the factory default value.

The value on the meter will change after you change the Adjust Value. Please check the value on the meter is in the range again. If value fits the condition, press the [Next] button to continue.

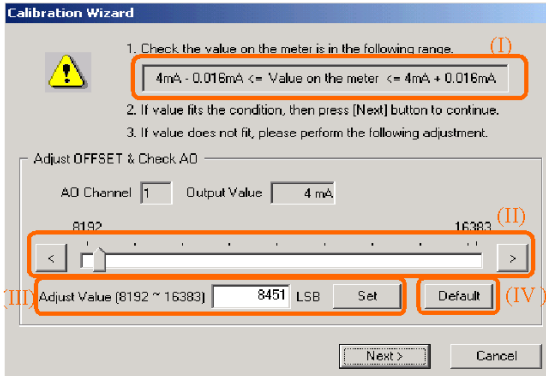

**Figure D.10: Adjustment of Offset Calibration**

**Step 6:** After offset calibration, this step is to adjust Span. The Wizard will output 20mA on the channel you selected. The steps of span calibration are quite similar to those of the offset calibration (Step 5). Follow the instructions of the *Calibration Wizard*. If the value fits the condition, press the [Next] button to continue.



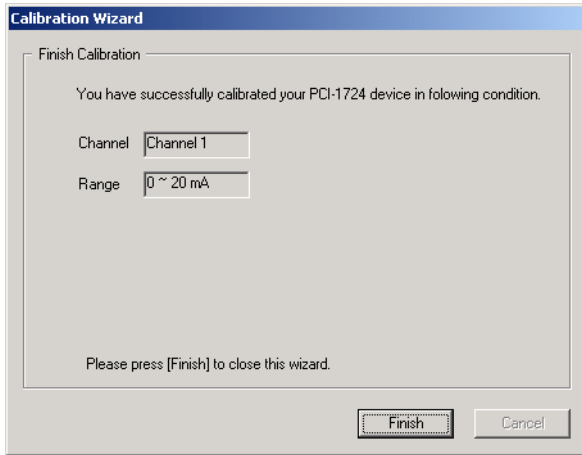

*Figure D.13: Finish Calibration*

**Step 9:** The wizard will pop up a dialog to inform you that the current calibration data of this channel will be overwritten if you click the [Yes] button. Otherwise click [No] to give up the data.

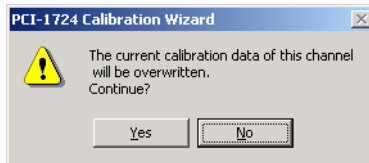

*Figure D.14: Data will be Overwritten*

