

User's Manual

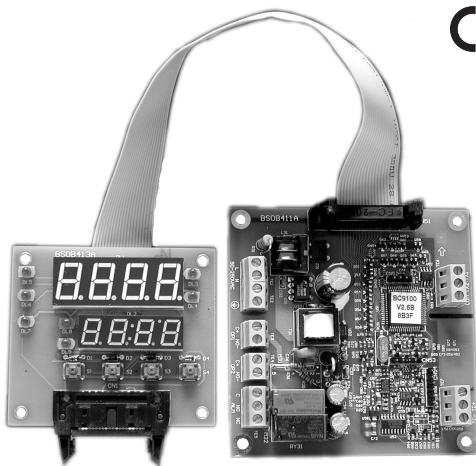

DIN EN ISO 9001
Certificate: 01 100 98505



B41 Board PID Process / Temperature Controller

UM0B411D

BCI BRAINCHILD

Warning Symbol

The Symbol calls attention to an operating procedure, practice, or the like, which, if not correctly performed or adhered to, could result in personal injury or damage to or destruction of part or all of the product and system. Do not proceed beyond a warning symbol until the indicated conditions are fully understood and met.

Use the Manual

- Installers Read Chapter 1, 2
- System Designer Read All Chapters
- Expert User Read Page 13

NOTE:

It is strongly recommended that a process should incorporate a LIMIT CONTROL like L91 which will shut down the equipment at a preset process condition in order to preclude possible damage to products or system.

Information in this user's manual is subject to change without notice.

This manual is applicable for the products with software version 29 and later version.

Copyright © February 2005, The Brainchild Corporation, all rights reserved. No part of this publication may be reproduced, transmitted, transcribed or stored in a retrieval system, or translated into any language in any form by any means without the written permission of the Brainchild Corporation.

Contents

	Page No		Page No
Chapter 1 Overview		Chapter 4 Applications	
1-1 General -----	5	4-1 Heat Only Control with Dwell Timer -----	51
1-2 Ordering Code -----	8	4-2 Cool Only Control -----	52
1-3 Programming Port -----	10	4-3 Heat-Cool Control -----	53
1-4 Keys and Displays -----	11	Chapter 5 Calibration -----	55
1-5 Menu Overview -----	13		
1-6 Parameter Descriptions ---	14		
Chapter 2 Installation		Chapter 6 Specifications ----	60
2-1 Unpacking -----	21		
2-2 Mounting -----	21	Chapter 7	
2-3 Wiring precautions -----	23	Modbus Communications ----	66
2-4 Power Wiring -----	25	7-1 Functions Supported -----	66
2-5 Sensor Installation		7-2 Exception Responses -----	68
Guidlines-----	25	7-3 Parameter Table -----	69
2-6 Sensor Input Wiring -----	26	7-4 Data Conversion -----	73
2-7 Control Output Wiring ----	26	7-5 Communication Examples-73	
2-8 Alarm Wiring -----	30		
2-9 Data Communication ----	31	Appendix	
Chapter 3 Programming		A-1 Error Codes -----	76
3-1 Lockout -----	33	A-2 Warranty -----	77
3-2 Signal Input -----	33		
3-3 Control Outputs -----	34		
3-4 Alarm -----	39		
3-5 Configure User Menu -----	40		
3-6 Ramp -----	41		
3-7 Dwell Timer -----	42		
3-8 PV Shift -----	43		
3-9 Digital Filter -----	44		
3-10 Failure Transfer -----	45		
3-11 Auto-tuning -----	46		
3-12 Manual tuning -----	47		
3-13 Manual Control -----	48		
3-14 Data Communication ----	50		
3-15 PV Retransmission -----	50		

Figure 1.1 Fuzzy Control Advantage	6
Figure 1.2 Programming Port Overview	10
Figure 1.3 Front Panel Description	12
Figure 1.4 Display of Initial Stage	12
Figure 2.1 Dimension of Control Board	22
Figure 2.2 Dimension of Display Board	22
Figure 2.3 Dimension of Mounting Plate for Display Board	23
Figure 2.4 Lead Termination	24
Figure 2.5 Terminal Connection	24
Figure 2.7 Power Supply Connections	25
Figure 2.8 Sensor Input Wiring	26
Figure 2.9 Output 1 Relay or Triac (SSR) to Drive Load	26
Figure 2.10 Output 1 Relay or Triac (SSR) to Drive Contactor	27
Figure 2.11 Output 1 Pulsed Voltage to Drive SSR	27
Figure 2.12 Output 1 Linear Current	28
Figure 2.13 Output 1 Linear Voltage	28
Figure 2.14 Output 2 Relay or Triac (SSR) to Drive Load	28
Figure 2.15 Output 2 Relay or Triac (SSR) to Drive Contactor	29
Figure 2.16 Output 2 Pulsed Voltage to Drive SSR	29
Figure 2.17 Output 2 Linear Current	29
Figure 2.18 Output 2 Linear Voltage	30
Figure 2.19 Alarm Output to Drive Load	30
Figure 2.20 Alarm Output to Drive Contactor	30
Figure 2.21 RS-485 Wiring	31
Figure 2.22 RS-232 Wiring	32
Figure 2.23 Configuration of RS-232 Cable	32
Figure 3.1 Conversion Curve for Linear Type Process Value	34
Figure 3.2 Heat Only ON-OFF Control	35
Figure 3.3 Output 2 Deviation High Alarm	38
Figure 3.4 Output 2 Process Low Alarm	38
Figure 3.5 RAMP Function	41
Figure 3.6 Dwell Timer Function	42
Figure 3.7 PV Shift Application	43
Figure 3.8 Filter Characteristics	44
Figure 3.9 Effects of PID Adjustment	49
Figure 4.1 Heat Control Example	51
Figure 4.2 Cooling Control Example	52
Figure 4.3 Heat-Cool Control Example	53
Figure 5.1 RTD Calibration	57
Figure 5.2 Cold Junction Calibration Setup	58
Table 1.1 Display Form of Characters	12
Table 3.1 Heat-Cool Control Setup Value	34
Table 3.2 PID Adjustment Guide	48
Table A.1 Error Codes and Corrective Actions	76

Chapter 1 Overview

1-1 General

The Fuzzy Logic plus PID microprocessor-based controller series, incorporate two bright, easy to read 4-digit LED displays, indicating process value and set point value. The Fuzzy Logic technology enables a process to reach a predetermined set point in the shortest time, with the minimum of overshoot during power-up or external load disturbance.

The unit is powered by 11-26 or 90-250 VDC /VAC supply, incorporating a 2 amp. control relay output as standard. The second output can be used as cooling control, or an alarm. Both outputs can select triac, 5V logic output, linear current or linear voltage to drive external device. There are six types of alarm plus a dwell timer can be configured for the third output. The units are fully programmable for PT100 and thermocouple types J, K, T, E, B, R, S, N, L with no need to modify the unit. The input signal is digitized by using a 18-bit A to D converter. Its fast sampling rate allows the unit to control fast processes.

Digital communications RS-485 or RS-232 are available as an additional option. These options allow the units to be integrated with supervisory control system and software.

A programming port is available for automatic configuration, calibration and testing without the need to access the keys on front panel.

By using proprietary Fuzzy modified PID technology, the control loop will minimize the overshoot and undershoot in a shortest time. The following diagram is a comparison of results with and without Fuzzy technology.

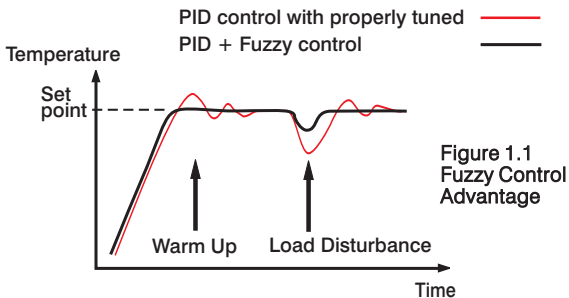

High Accuracy

The series are manufactured with custom designed ASIC (Application Specific Integrated Circuit) technology which contains a 18-bit A to D converter for high resolution measurement (true 0.1 °F resolution for thermocouple and PT100) and a 15-bit D to A converter for linear current or voltage control output. The ASIC technology provides improved operating performance, low cost, enhanced reliability and higher density.

Fast Sampling Rate

The sampling rate of the input A to D converter reaches 5 times/second. The fast sampling rate allows this series to control fast processes.

Fuzzy Control

The function of Fuzzy control is to adjust PID parameters from time to time in order to make manipulation output value more flexible and adaptive to various processes. The results is to enable a process to reach a predetermined set point in the shortest time, with the minimum of overshoot and undershoot during power-up or external load disturbance.

Digital Communication

The units are equipped with RS-485 or RS-232 interface card to provide digital communication. By using the twisted pair wires there are at most 247 units can be connected together via RS-485 interface to a host computer.

Programming Port

A programming port is used to connect the unit to a hand-held programmer or a PC for quick configuration, also can be connected to an ATE system for automatic testing & calibration.

Auto-tune

The auto-tune function allows the user to simplify initial setup for a new system. A clever algorithm is provided to obtain an optimal set of control parameters for the process, and it can be applied either as the process is warming up (cold start) or as the process has been in steady state (warm start).

Lockout Protection

According to actual security requirement, one of four lockout levels can be selected to prevent the unit from being changed abnormally.

Bumpless Transfer

Bumpless transfer allows the controller to continue to control by using its previous value as the sensor breaks. Hence, the process can be well controlled temporarily as if the sensor is normal.

Soft-start Ramp

The ramping function is performed during power up as well as any time the set point is changed. It can be ramping up or ramping down. The process value will reach the set point with a predetermined constant rate.

Digital Filter

A first order low pass filter with a programmable time constant is used to improve the stability of process value. This is particularly useful in certain application where the process value is too unstable to be read.

SEL Function

The units have the flexibility for user to select those parameters which are most significant to him and put these parameters in the front of display sequence. There are at most 8 parameters can be selected to allow the user to build his own display sequence.

1-2 Ordering Code

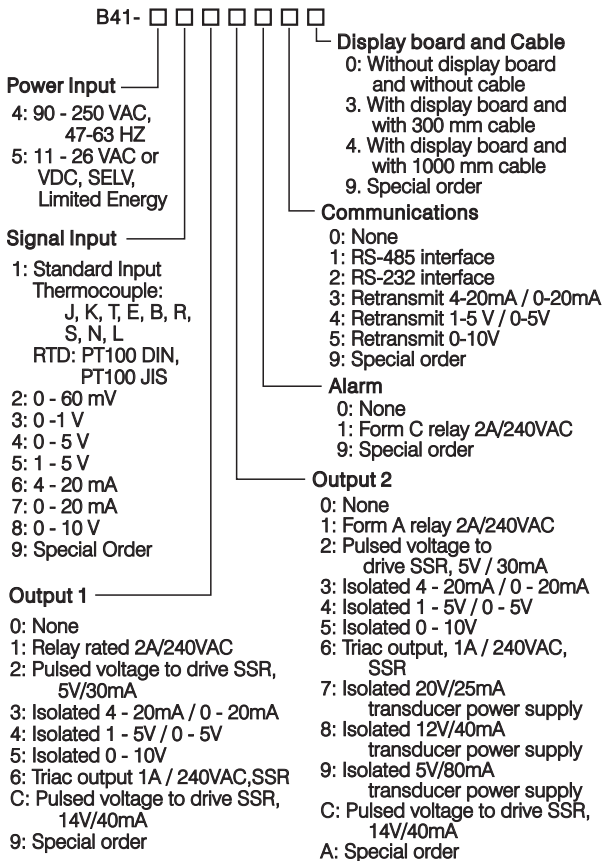

Accessories

- OM94-6 = Isolated 1A / 240VAC Triac Output Module (SSR)
- OM94-7 = 14V / 40mA SSR Drive Module
- OM96-3 = Isolated 4 - 20 mA / 0 - 20 mA Analog Output Module
- OM96-4 = Isolated 1 - 5V / 0 - 5V Analog Output Module
- OM96-5 = Isolated 0 -10V Analog Output Module
- CM94-1 = Isolated RS-485 Interface Module
- CM94-2 = Isolated RS-232 Interface Module
- CM94-3 = Isolated 4 - 20 mA / 0 - 20 mA Retrains Module
- CM94-4 = Isolated 1 - 5V / 0 - 5V Retrains Module
- CM94-5 = Isolated 0-10V Retrains Module
- DC94-1 = Isolated 20V/25mA DC Output Power Supply
- DC94-2 = Isolated 12V/40mA DC Output Power Supply
- DC94-3 = Isolated 5V/80mA DC Output Power Supply
- CC94-1 = RS-232 Interface Cable (2M)
- CC91-2 = Programming Port Cable

Related Products

- SNA10A = Smart Network Adaptor for third party software, which converts 255 channels of RS-485 or RS-422 to RS-232 Network.
- SNA12A = Smart Network Adapter for programming port to RS-232 interface
- BC-Set = Free Configuration Software
- Communicator: PC software to communicate 1024 tags

1-3 Programming Port

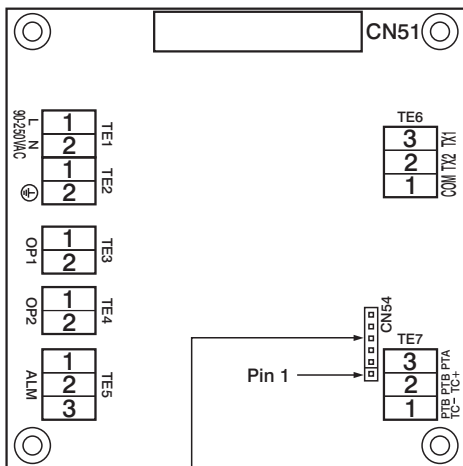

Programming Port

Figure 1.2
Programming Port
Overview

A special connector can be used to touch the programming port which is connected to a smart network adaptor SNA12A and a PC for automatic configuration, also can be connected to an ATE system for automatic calibration and testing.

The programming port is used for off-line automatic setup and testing procedures only. Don't attempt to make any connection to these pins when the unit is used for a normal control purpose.

1- 4 Keys and Displays

KEYPAD OPERATION

SCROLL KEY :

This key is used to select a parameter to be viewed or adjusted.

UP KEY :

This key is used to increase the value of selected parameter.

DOWN KEY :

This key is used to decrease the value of selected parameter.



RESET KEY :

This key is used to:

1. Revert the display to display the process value.
2. Reset the latching alarm, once the alarm condition is removed.
3. Stop the manual control mode , auto-tuning mode and calibration mode.
4. Clear the message of communication error and auto-tuning error.
5. Restart the dwell timer when the dwell timer has been time out.
6. Enter the manual control menu during failure mode occurs.

ENTER KEY : Press  for 5 seconds or longer .

Press  for 5 seconds to:

1. Enter setup menu. The display shows  .
2. Enter manual control mode during manual control mode  is selected.
3. Enter auto-tuning mode during auto-tuning mode  is selected.
4. Perform calibration to a selected parameter during the calibration procedure.

Press  for 6.2 seconds to select manual control mode.

Press  for 7.4 seconds to select auto-tuning mode.

Press  for 8.6 seconds to select calibration mode.

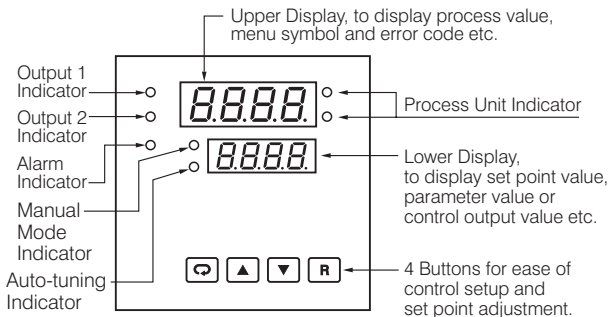
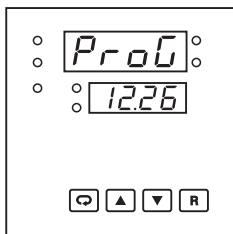

Figure 1.3 Front Panel Description

Table 1.1 Display Form of Characters

A	<i>A</i>	E	<i>E</i>	I	<i>I</i>	N	<i>N</i>	S	<i>S</i>	X	
B	<i>b</i>	F	<i>F</i>	J	<i>J</i>	O	<i>O</i>	T	<i>t</i>	Y	<i>Y</i>
C	<i>C</i>	G	<i>G</i>	K	<i>K</i>	P	<i>P</i>	U	<i>u</i>	Z	
c	<i>c</i>	H	<i>H</i>	L	<i>L</i>	Q		V	<i>v</i>	?	<i>?</i>
D	<i>d</i>	h	<i>h</i>	M	<i>M</i>	R	<i>r</i>	W		=	<i>=</i>

⚠: Confused Character



Display program code of the product for 2.5 seconds.

The left diagram shows program no. 12 with version 26.

Figure 1.4
Display of Initial Stage

1-5 Menu Overview

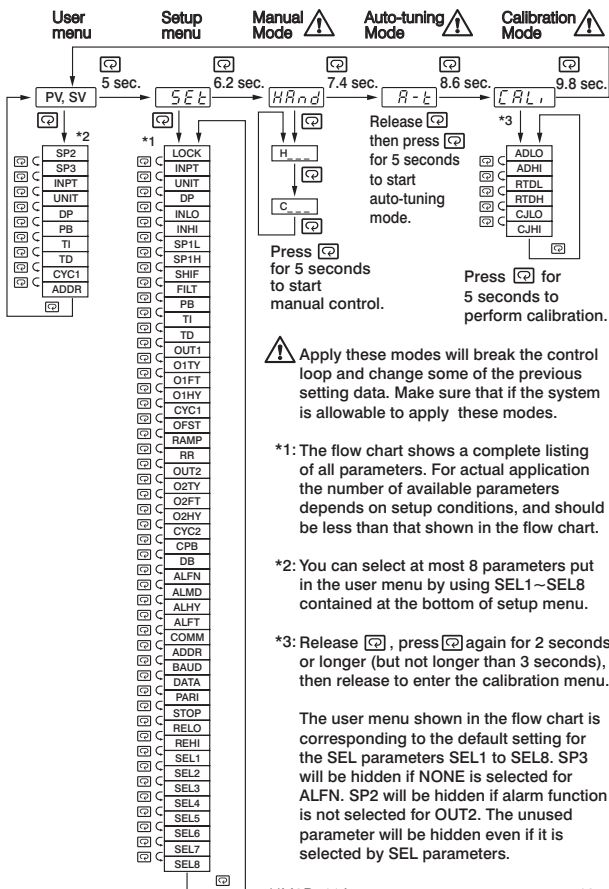

1-6 Parameter Descriptions

Parameter Notation	Parameter Description	Range	Default Value
SP1	Set point for output 1	Low: SP1L High :SP1H	25.0 °C (77.0°F)
SP2	Set point for output 2 when output 2 performs alarm function	Low: -19999 High :45536	10.0 °C (18.0°F)
SP3	Set point for alarm or dwell timer output	Low: -19999 High: 45536	10.0 °C (18.0 °F)
LOCK	Select parameters to be locked	<p>0 <i>nonE</i>: No parameter is locked</p> <p>1 <i>SEt</i>: Setup data are locked</p> <p>2 <i>uSEr</i>: Setup data and User data except Set point are locked</p> <p>3 <i>ALL</i>: All data are locked</p>	0
INPT	Input sensor selection	<p>0 <i>J-tC</i>: J type thermocouple</p> <p>1 <i>K-tC</i>: K type thermocouple</p> <p>2 <i>T-tC</i>: T type thermocouple</p> <p>3 <i>E-tC</i>: E type thermocouple</p> <p>4 <i>B-tC</i>: B type thermocouple</p> <p>5 <i>R-tC</i>: R type thermocouple</p> <p>6 <i>S-tC</i>: S type thermocouple</p> <p>7 <i>n-tC</i>: N type thermocouple</p> <p>8 <i>L-tC</i>: L type thermocouple</p> <p>9 <i>Pt.dn</i>: PT 100 ohms DIN curve</p> <p>10 <i>Pt.JS</i>: PT 100 ohms JIS curve</p> <p>11 <i>4-20</i>: 4 - 20 mA linear current input</p> <p>12 <i>0-20</i>: 0 - 20 mA linear current input</p> <p>13 <i>0-60</i>: 0 - 60 mV linear millivolt input</p> <p>14 <i>0-1V</i>: 0 - 1V linear voltage input</p> <p>15 <i>0-5V</i>: 0 - 5V linear voltage input</p> <p>16 <i>1-5V</i>: 1 - 5V linear voltage input</p> <p>17 <i>0-10</i>: 0 - 10V linear voltage input</p>	1 (0)

Parameter Notation	Parameter Description	Range	Default Value
UNIT	Input unit selection	0 0C : Degree C unit 1 0F : Degree F unit 2 PV : Process unit	0 (1)
DP	Decimal point selection	0 noDP : No decimal point 1 1-DP : 1 decimal digit 2 2-DP : 2 decimal digits 3 3-DP : 3 decimal digits	1
INLO	Input low scale value	Low: -19999 High: 45486	-17.8 °C (0 °F)
INH1	Input high scale value	Low: INLO+50 High: 45536	93.3 °C (200.0 °F)
SP1L	Low limit of set point value	Low: -19999 High: 45536	-17.8 °C (0 °F)
SP1H	High limit of set point value	Low: SP1L High: 45536	537.8 °C (1000 °F)
SHIF	PV shift (offset) value	Low: -200.0 °C (-360.0 °F) High: 200.0 °C (360.0 °F)	0.0
FILT	Filter damping time constant of PV	0 0 : 0 second time constant 1 0.2 : 0.2 second time constant 2 0.5 : 0.5 second time constant 3 1 : 1 second time constant 4 2 : 2 seconds time constant 5 5 : 5 seconds time constant 6 10 : 10 seconds time constant 7 20 : 20 seconds time constant 8 30 : 30 seconds time constant 9 60 : 60 seconds time constant	2

Parameter Notation	Parameter Description	Range	Default Value
PB	Proportional band value	Low: 0 High: 500.0 °C (900.0 °F)	10.0 °C (18.0 °F)
TI	Integral time value	Low: 0 High: 3600 sec	100
TD	Derivative time value	Low: 0 High: 360.0 sec	25.0
OUT1	Output 1 function	0 <i>rEYr</i> : Reverse (heating) control action 1 <i>dir t</i> : Direct (cooling) control action	0
O1TY	Output 1 signal type	0 <i>rELY</i> : Relay output 1 <i>SSrd</i> : Solid state relay drive output 2 <i>SSr</i> : Solid state relay output 3 <i>4-20</i> : 4-20 mA current module 4 <i>0-20</i> : 0 - 20 mA current module 5 <i>0-1V</i> : 0 - 1V voltage module 6 <i>0-5V</i> : 0 - 5V voltage module 7 <i>1-5V</i> : 1 - 5V voltage module 8 <i>0-10</i> : 0 - 10V voltage module	0
O1FT	Output 1 failure transfer mode	Select BPLS (bumpless transfer) or 0.0 ~ 100.0 % to continue output 1 control function as the unit fails, or select OFF (0) or ON (1) for ON-OFF control.	0
O1HY	Output 1 ON-OFF control hysteresis	Low: 0.1 High: 50.0 °C(90.0°F)	0.1°C (0.2°F)
CYC1	Output 1 cycle time	Low: 0.1 High: 90.0 sec.	18.0
OFST	Offset value for P control	Low: 0 High: 100.0 %	25.0
RAMP	Ramp function selection	0 <i>nonE</i> : No Ramp Function 1 <i>ni nr</i> : Use unit/minute as Ramp Rate 2 <i>Hr,r</i> : Use unit/hour as Ramp Rate	0

Parameter Notation	Parameter Description	Range	Default Value
RR	Ramp rate	Low: 0 High: 500.0 °C (900.0 °F)	0.0
OUT2	Output 2 function	0 <i>nonE</i> : Output 2 No Function 2 <i>dEH</i> : Deviation High Alarm 3 <i>dEL</i> : Deviation Low Alarm 6 <i>PYH</i> : Process High Alarm 7 <i>PYL</i> : Process Low Alarm 8 <i>COOL</i> : Cooling PID Function 9 <i>dHHo</i> : Deviation High Alarm with Hold Function 10 <i>dLHo</i> : Deviation Low Alarm with Hold Function 11 <i>PHHo</i> : Process High Alarm with Hold Function 12 <i>PLHo</i> : Process Low Alarm with Hold Function	2
O2TY	Output 2 signal type	0 <i>reLY</i> : Relay output 1 <i>SSrd</i> : Solid state relay drive output 2 <i>SSr</i> : Solid state relay output 3 <i>4-20</i> : 4-20 mA current module 4 <i>0-20</i> : 0-20 mA current module 5 <i>0-1V</i> : 0 - 1V voltage module 6 <i>0-5V</i> : 0 - 5V voltage module 7 <i>1-5V</i> : 1 - 5V voltage module 8 <i>0-10</i> : 0 - 10V voltage module	0
O2FT	Output 2 failure transfer mode	Select BPLS (bumpless transfer) or 0.0 ~ 100.0 % to continue output 2 control function as the unit fails, or select ON (0) or OFF (1) for alarm function.	0
O2HY	Output 2 hysteresis value when output 2 performs alarm function	Low: 0.1 High: 50.0 °C (90.0 °F)	0.1 °C (0.2 °F)
CYC2	Output 2 cycle time	Low: 0.1 High: 90.0 sec.	18.0
CPB	Cooling proportional band value	Low: 50 High: 300 %	100

Parameter Notation	Parameter Description	Range	Default Value
DB	Heating-cooling dead band (negative value=overlap)	Low: -36.0 High: 36.0 %	0
ALFN	Alarm function for alarm output	0 <i>nonE</i> :No alarm function 1 <i>t_inr</i> :Dwell timer action 2 <i>dE.H_i</i> :Deviation high alarm 3 <i>dE.L_o</i> :Deviation low alarm 4 <i>db.H_i</i> :Deviation band out of band alarm 5 <i>db.L_o</i> :Deviation band in band alarm 6 <i>P_y.H_i</i> :Process value high alarm 7 <i>P_y.L_o</i> :Process value low alarm	2
ALMD	Alarm operation mode	0 <i>nor\bar{n}</i> : Normal alarm action 1 <i>Ltch</i> : Latching alarm action 2 <i>Hold</i> : Hold alarm action 3 <i>LtHo</i> : Latching & Hold action 4 <i>SPHo</i> : Set point holding alarm	0
ALHY	Hysteresis control of alarm	Low: 0.1 High: 50.0 °C (90.0 °F)	0.1 °C (0.2 °F)
ALFT	Alarm failure transfer mode	0 <i>on</i> : Alarm output ON as unit fails 1 <i>off</i> : Alarm output OFF as unit fails	0
COMM	Communication function	0 <i>nonE</i> : No communication 1 <i>rtu</i> : Modbus RTU mode protocol 2 <i>4-20</i> :4-20mA retransmission output 3 <i>0-20</i> :0-20mA retransmission output 4 <i>0-5V</i> :0-5V retransmission output 5 <i>1-5V</i> :1-5V retransmission output 6 <i>0-10</i> :0-10V retransmission output	1

Parameter Notation	Parameter Description	Range		Default Value
ADDR	Address assignment of digital communication	Low: 1	High: 255	—
BAUD	Baud rate of digital communication	0	<i>24</i> : 2.4 Kbits/s baud rate	2
		1	<i>48</i> : 4.8 Kbits/s baud rate	
		2	<i>96</i> : 9.6 Kbits/s baud rate	
		3	<i>144</i> : 14.4 Kbits/s baud rate	
		4	<i>192</i> : 19.2 Kbits/s baud rate	
		5	<i>288</i> : 28.8 Kbits/s baud rate	
		6	<i>384</i> : 38.4 Kbits/s baud rate	
DATA	Data bit count of digital communication	0	<i>7b, t</i> : 7 data bits	1
		1	<i>8b, t</i> : 8 data bits	
PARI	Parity bit of digital communication	0	<i>EVEN</i> : Even parity	0
		1	<i>odd</i> : Odd parity	
		2	<i>none</i> : No parity bit	
STOP	Stop bit count of digital communication	0	<i>1b, t</i> : One stop bit	0
		1	<i>2b, t</i> : Two stop bits	
RELO	Retransmission low scale value	Low: -19999	High: 45536	0.0 °C (32.0 °F)
REHI	Retransmission high scale value	Low: -19999	High: 45536	100.0 °C (212.0 °F)
SEL1	Select 1'st parameter for user menu	0	<i>none</i> : No parameter selected	2
		1	<i>LOCK</i> : LOCK is put ahead	
		2	<i>INPT</i> : INPT is put ahead	
		3	<i>UNIT</i> : UNIT is put ahead	
		4	<i>DP</i> : DP is put ahead	
		5	<i>SHIF</i> : SHIF is put ahead	
		6	<i>PB</i> : PB is put ahead	
		7	<i>TI</i> : TI is put ahead	

Parameter Notation	Parameter Description	Range	Default Value
SEL1	Select 1'st parameter for user menu	8 <i>td</i> :TD is put ahead 9 <i>O1HY</i> : O1HY is put ahead 10 <i>CYC1</i> : CYC1 is put ahead 11 <i>OFST</i> : OFST is put ahead 12 <i>RR</i> :RR is put ahead 13 <i>O2HY</i> :O2HY is put ahead 14 <i>CYC2</i> :CYC2 is put ahead 15 <i>CPB</i> :CPB is put ahead 16 <i>DB</i> :DB is put ahead 17 <i>ADDR</i> :ADDR is put ahead 18 <i>ALHY</i> :ALHY is put ahead	2
SEL2	Select 2'nd parameter for user menu	Same as SEL1	3
SEL3	Select 3'rd parameter for user menu	Same as SEL1	4
SEL4	Select 4'th parameter for user menu	Same as SEL1	6
SEL5	Select 5'th parameter for user menu	Same as SEL1	7
SEL6	Select 6'th parameter for user menu	Same as SEL1	8
SEL7	Select 7'th parameter for user menu	Same as SEL1	10
SEL8	Select 8'th parameter for user menu	Same as SEL1	17

Chapter 2 Installation

 Dangerous voltages capable of causing death are sometimes present in this instrument. Before installation or beginning any cleaning or troubleshooting procedures the power to all equipment must be switched off and isolated. Units suspected of being faulty must be disconnected and removed to a properly equipped workshop for testing and repair. Component replacement and internal adjustments must be made by a qualified maintenance person only.

 This instrument is protected through out by Double Insulation To minimize the possibility of fire or shock hazards, do not expose this instrument to rain or excessive moisture.

 Do not use this instrument in areas under hazardous conditions such as excessive shock, vibration, dirt, moisture, corrosive gases or oil. The ambient temperature of the areas should not exceed the maximum rating specified in Chapter 6.

 Remove stains from this instrument using a soft, dry cloth. Don't use harsh chemicals, volatile solvent such as thinner or strong detergents to clean the instrument in order to avoid deformation or discoloration.

2-1 Unpacking

Upon receipt of the shipment remove the unit from the carton and inspect the unit for shipping damage.

If any damage due to transit, report and claim with the carrier.

Write down the model number, serial number, and date code for future reference when corresponding with our service center. The serial number (S/N) and date code (D/C) are labeled on the box and the housing of controller.

2-2 Mounting

The dimension of control board, display board and the mounting plate for display board are as shown in Figure 2.1 through 2.3.

Figure 2.1 Dimension of Control Board

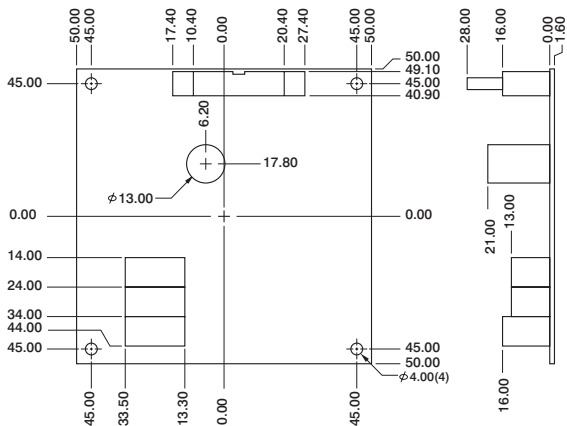

Figure 2.2 Dimension of Display Board

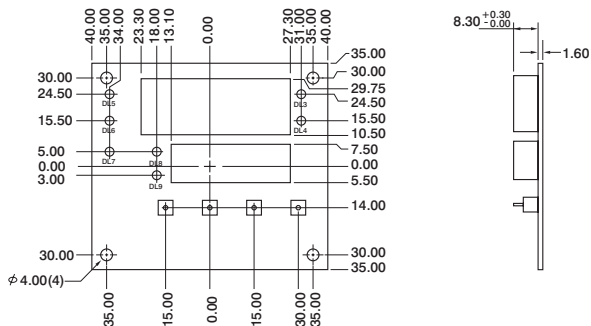
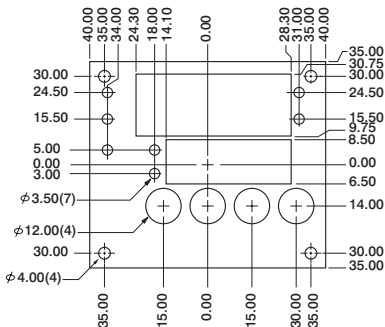

Figure 2.3 Dimension of Mounting plate for Display Board



2 - 3 Wiring Precautions

- * Before wiring, verify the label for correct model number and options. Switch off the power while checking.
- * Care must be taken to ensure that maximum voltage rating specified on the label are not exceeded.
- * It is recommended that power of these units to be protected by fuses or circuit breakers rated at the minimum value possible.
- * All units should be installed inside a suitably grounded metal enclosure to prevent live parts being accessible from human hands and metal tools.
- * All wiring must conform to appropriate standards of good practice and local codes and regulations. Wiring must be suitable for voltage, current, and temperature rating of the system.
- * Beware not to over-tighten the terminal screws. The torque should not exceed 1 N-m (8.9 Lb-in or 10.2KgF-cm).

- * Unused control terminals should not be used as jumper points as they may be internally connected, causing damage to the unit.
- * Verify that the ratings of the output devices and the inputs as specified in Chapter 6 are not exceeded.
- * Except the thermocouple wiring, all wiring should use stranded copper conductor with maximum gauge 18 AWG.

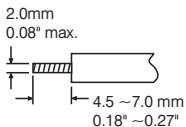

Figure 2.4 Lead Termination

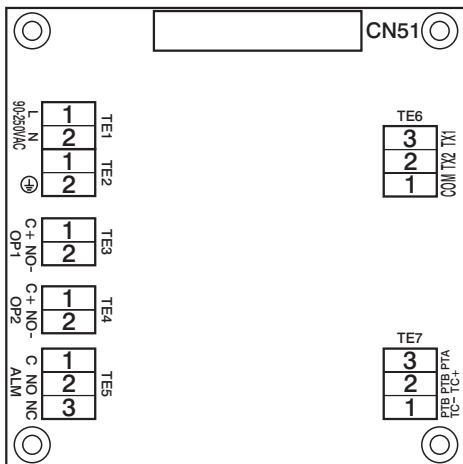

Figure 2.5 Terminal Connection

2 - 4 Power Wiring

The controller is supplied to operate at 11-26 VAC / VDC or 90-250 VAC. Check that the installation voltage corresponds with the power rating indicated on the product label before connecting power to the controller. Near the controller a fuse and a switch rated at 2A/250VAC should be equipped as shown in the following diagram.

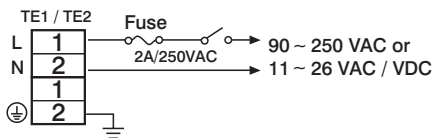

Figure 2.7 Power Supply Connections



This equipment is designed for installation in an enclosure which provides adequate protection against electric shock. The enclosure must be connected to earth ground.

Local requirements regarding electrical installation should be rigidly observed. Consideration should be given to prevent from unauthorized person access to the power terminals.

2-5 Sensor Installation Guidelines

Proper sensor installation can eliminate many problems in a control system. The probe should be placed so that it can detect any temperature change with minimal thermal lag. In a process that requires fairly constant heat output, the probe should be placed closed to the heater. In a process where the heat demand is variable, the probe should be closed to the work area. Some experiments with probe location are often required to find this optimum position.

In a liquid process, addition of a stirrer will help to eliminate thermal lag. Since the thermocouple is basically a point measuring device, placing more than one thermocouple in parallel can provide an average temperature readout and produce better results in most air heated processes.

Proper sensor type is also a very important factor to obtain precise measurements. The sensor must have the correct temperature range to meet the process requirements. In special processes the sensor might need to have different requirements such as leak-proof, anti-vibration, antiseptic, etc.

Standard sensor limits of error are ± 4 degrees F (± 2 degrees C) or 0.75% of sensed temperature (half that for special) plus drift caused by improper protection or an over-temperature occurrence. This error is far greater than controller error and cannot be corrected on the sensor except by proper selection and replacement.

2-6 Sensor Input Wiring

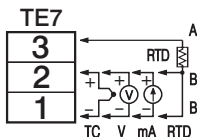

Figure 2.8 Sensor Input Wiring

2-7 Control Output Wiring

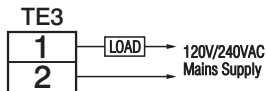

Figure 2.9
Output 1 Relay or Triac (SSR) to Drive Load

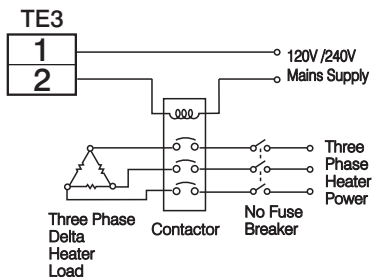

Figure 2.10
Output 1 Relay or Triac (SSR) to Drive Contactor

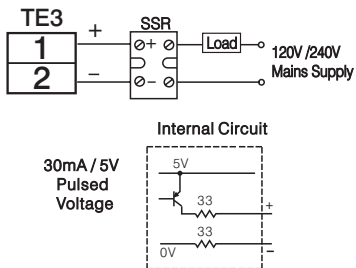

Figure 2.11 Output 1 Pulsed Voltage to Drive SSR

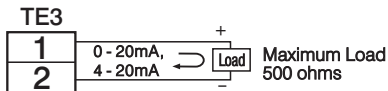

Figure 2.12 Output 1 Linear Current

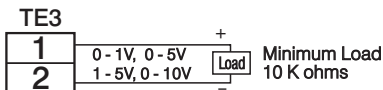

Figure 2.13 Output 1 Linear Voltage

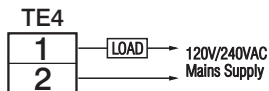

Figure 2.14
Output 2 Relay or Triac (SSR) to Drive Load

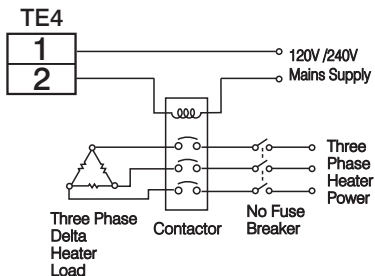

Figure 2.15
Output 2 Relay or Triac (SSR) to Drive Contactor

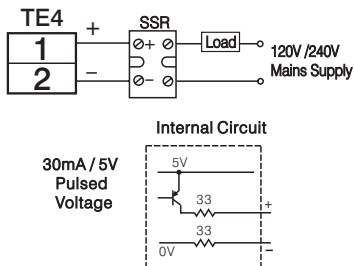

Figure 2.16 Output 2 Pulsed Voltage to Drive SSR

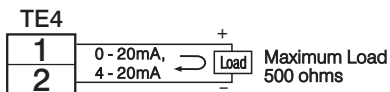

Figure 2.17 Output 2 Linear Current

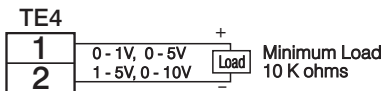

Figure 2.18 Output 2 Linear Voltage

2-8 Alarm Wiring

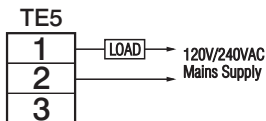

Figure 2.19 Alarm Output to Drive Load

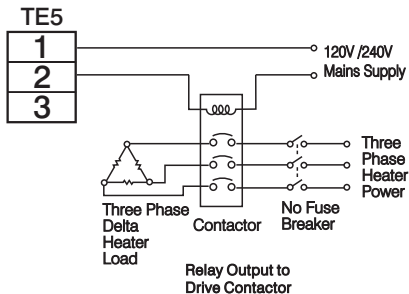

Figure 2.20 Alarm Output to Drive Contactor

2-9 Data Communication

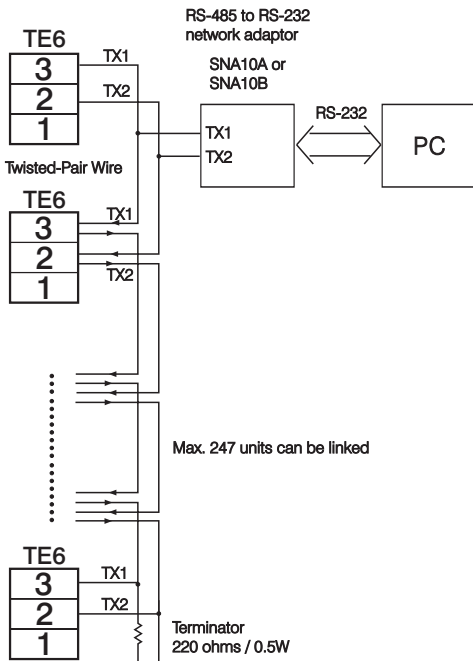

Figure 2.21 RS-485 Wiring

RS-232

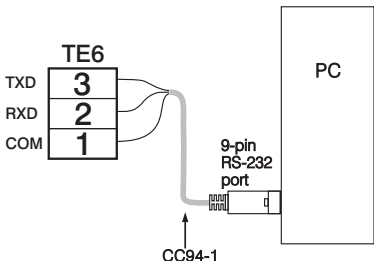

Figure 2.22
RS-232 Wiring

If you use a conventional 9-pin RS-232 cable instead of CC94-1, the cable must be modified according to the following circuit diagram.

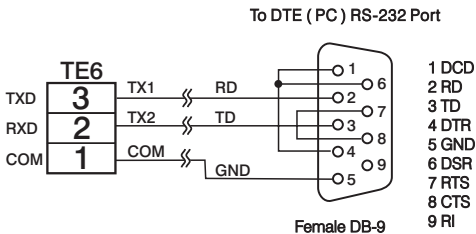



Figure 2.23
Configuration of RS-232 Cable

Chapter 3 Programming

Press  for 5 seconds and release to enter setup menu. Press  to select the desired parameter. The upper display indicates the parameter symbol, and the lower display indicates the selected value of parameter.

3-1 Lockout

There are four security levels can be selected by using LOCK parameter.

If **NONE** is selected for LOCK, then no parameter is locked.

If **SET** is selected for LOCK, then all setup data are locked.

If **USER** is selected for LOCK, then all setup data as well as user data (refer to **section 1-5**) except set point are locked to prevent from being changed.

If **ALL** is selected for LOCK, then all parameters are locked to prevent from being changed.

3-2 Signal Input

INPT: Selects the sensor type or signal type for signal input.

Range: (thermocouple) J_TC, K_TC, T_TC, E_TC, B_TC, R_TC
S_TC, N_TC, L_TC
(RTD) PT.DN, PT.JS
(linear) 4-20, 0-20, 0-60, 0-1V, 0-5V, 1-5V, 0-10

UNIT: Selects the process unit

Range: °C, °F, PU(process unit). If the unit is neither °C nor °F, then selects PU.

DP: Selects the resolution of process value.

Range: (for T/C and RTD) NO.DP, 1-DP
(for linear) NO.DP, 1-DP, 2-DP, 3-DP

INLO: Selects the low scale value for the linear type input.

INHI : Selects the high scale value for the linear type input.

How to use INLO and INHI :

If 4 - 20 mA is selected for INPT, let SL specifies the input signal low (ie. 4 mA), SH specifies the input signal high (ie. 20 mA), S specifies the current input signal value, the conversion curve of the process value is shown as follows :

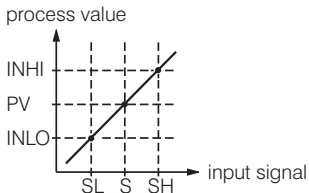

Figure 3.1
Conversion Curve for
Linear Type Process Value

$$\text{Formula : } PV = \text{INLO} + (\text{INHI} - \text{INLO}) \frac{S - \text{SL}}{\text{SH} - \text{SL}}$$

Example : A 4-20 mA current loop pressure transducer with range 0 - 15 kg/cm² is connected to input, then perform the following setup :

INPT = 4 - 20 INLO = 0.00

INHI = 15.00 DP = 2-DP

Of course, you may select other value for DP to alter the resolution.

3-3 Control Outputs

There are 4 kinds of control modes can be configured as shown in **Table 3.1 Heat-Cool Control Setup Value**

Control Modes	OUT1	OUT2	O1HY	O2HY	CPB	DB
Heat only	REVR	×	☆	×	×	×
Cool only	DIRT	×	☆	×	×	×
Heat: PID Cool: ON-OFF	REVR	DE.HI	×	○	×	×
Heat: PID Cool: PID	REVR	COOL	×	×	○	○

× : Don't care

○ : Adjust to met process requirements

☆: Required if ON-OFF control is configured

Heat Only ON-OFF Control : Select REVR for OUT1, Set PB to 0, O1HY is used to adjust dead band for ON-OFF control, The output 1 hysteresis (O1HY) is enabled in case of PB = 0 . The heat only on-off control function is shown in the following diagram :

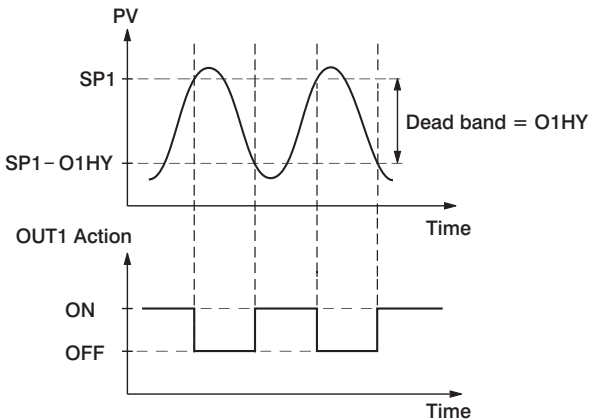

Figure 3.2 Heat Only ON-OFF Control

The ON-OFF control may introduce excessive process oscillation even if hysteresis is minimized to the smallest. If ON-OFF control is set (ie. PB = 0), TI, TD, CYC1, OFST, CYC2, CPB, DB will be hidden and have no function to the system. The auto-tuning mode and bumpless transfer will be disabled too.

Heat only P (or PD) control : Select REVR for OUT1, set TI to 0, OFST is used to adjust the control offset (manual reset). **O1HY is hidden** if PB is not equal to 0. **OFST Function** : OFST is measured by % with range 0 - 100.0 %. In the steady state (ie. process has been stabilized) if the process value is lower than the set point a definite value, say 5 °C, while 20 °C is used for PB, that is lower 25 %,

then increase OFST 25 %, and vice versa. After adjusting OFST value, the process value will be varied and eventually, coincide with set point. Using the P control (TI set to 0), the auto-tuning is disabled. Refer to section 3-12 " manual tuning " for the adjustment of PB and TD. Manual reset (adjust OFST) is not practical because the load may change from time to time and often need to adjust OFST repeatedly. The PID control can avoid this situation.

Heat only PID control : Selecting REVR for OUT1, PB and TI should not be zero. Operate auto-tuning for the new process, or set PB, TI and TD with historical values. See section 3-11 for auto-tuning operation. If the control result is still unsatisfactory, then use manual tuning to improve the control . See section 3-12 for manual tuning. The unit contains a **very clever PID and Fuzzy** algorithm to achieve a **very small overshoot and very quick response** to the process if it is properly tuned.

Cool only control:ON-OFF control, P (PD) control and PID control can be used for cool control. Set OUT1 to DIRT (direct action). The other functions for cool only ON-OFF control, cool only P (PD) control and cool only PID control are same as descriptions for heat only control except that the output variable (and action) for the cool control is inverse to the heat control.

NOTE : The ON-OFF control may result excessive overshoot and undershoot problems in the process. The P (or PD) control will result in a deviation process value from the set point. It is recommended to use PID control for the Heat-Cool control to produce a stable and zero offset process value.

Other Setup Required : O1TY, CYC1, O2TY, CYC2, O1FT, O2FT
O1TY & O2TY are set in accordance with the types of OUT1 & OUT2 installed. CYC1 & CYC2 are selected according to the output 1 type (O1TY) & output 2 type (O2TY). Generally, selects 0.5 ~ 2 sec. for CYC1, if SSRD or SSR is used for O1TY; 10 ~ 20 sec. if relay is used for O1TY, and CYC1 is ignored if linear output is used. Similar condition is applied for CYC2 selection.

You can use the **auto-tuning** program for the new process or directly set the appropriate values for PB, TI & TD according to the historical records for the repeated systems. If the control behavior is still inadequate, then use **manual tuning** to improve the control. See **section 3-12** for manual tuning.

CPB Programming : The cooling proportional band is measured by % of PB with range 50~300. Initially set 100% for CPB and examine the cooling effect. If cooling action should be enhanced then decrease CPB, if cooling action is too strong then increase CPB. The value of CPB is related to PB and its value remains unchanged throughout the auto-tuning procedures.

Adjustment of CPB is related to the cooling media used. For air is used as cooling media, adjust CPB at 100%. For oil is used as cooling media, adjust CPB at 125%. For water is used as cooling media, adjust CPB at 250%.

DB Programming: Adjustment of DB is dependent on the system requirements. If more positive value of DB (greater dead band) is used, an unwanted cooling action can be avoided but an excessive overshoot over the set point will occur. If more negative value of DB (greater overlap) is used, an excessive overshoot over the set point can be minimized but an unwanted cooling action will occur. It is adjustable in the range -36.0% to 36.0 % of PB. A negative DB value shows an overlap area over which both outputs are active. A positive DB value shows a dead band area over which neither output is active.

Output 2 ON-OFF Control (Alarm function): The output 2 can also be configured as alarm function. There are 8 kinds of alarm functions can be selected for output 2, these are: **DE.HI** (deviation high alarm), **DE.LO** (deviation low alarm), **PV.HI** (process high alarm), **PV.LO** (process low alarm), **DHHO** (deviation high alarm with hold function), **DLHO** (deviation low alarm with hold function), **PHHO** (process high alarm with hold function), and **PLHO** (process low alarm with hold function). The hold function includes both cases of power up and changing set point. Refer to **Figure 3.3** and **Figure 3.4** for the description of deviation alarm and process alarm.

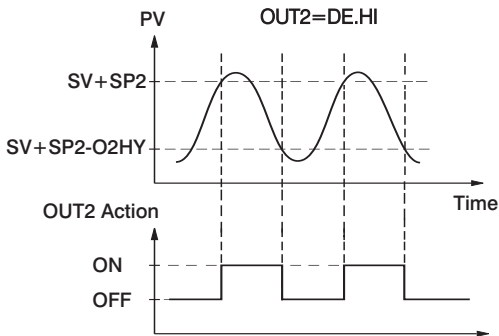

Figure 3.3 Output 2 Deviation High Alarm

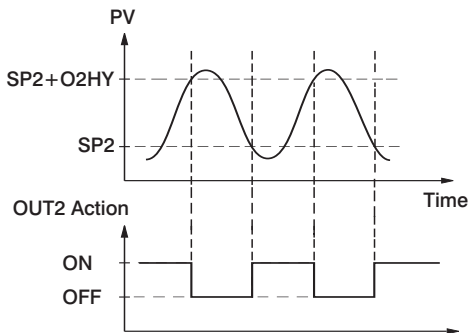

Figure 3.4 Output 2 Process Low Alarm

3-4 Alarm

The controller has one alarm output. There are 6 types of alarm functions and one dwell timer can be selected, and four kinds of alarm modes (ALMD) are available for each alarm function (ALFN). Besides the alarm output, the output 2 can also be configured as another alarm. But output 2 only provides 4 kinds of alarm functions and only normal alarm mode is available for this alarm.

A process alarm sets two absolute trigger levels. When the process is higher than SP3, a process high alarm (PV.HI) occurs, and the alarm is off as the process is lower than SP3-ALHY. When the process is lower than SP3, a process low alarm (PV.LO) occurs and the alarm is off as the process is higher than SP3+ALHY. A process alarm is independent of set point.

A deviation alarm alerts the user when the process deviates too far from set point. When the process is higher than SV+SP3, a deviation high alarm (DE.HI) occurs and the alarm is off as the process is lower than SV+SP3-ALHY. When the process is lower than SV+SP3, a deviation low alarm (DE.LO) occurs and the alarm is off as the process is higher than SV+SP3+ALHY. Trigger level of deviation alarm is moving with set point.

A deviation band alarm presets two trigger levels relative to set point. The two trigger levels are SV+SP3 and SV - SP3 for alarm. When the process is higher than (SV+SP3) or lower than (SV - SP3), a deviation band high alarm (DB.HI) occurs. When the process is within the trigger levels, a deviation band low alarm (DB.LO) occurs.

In the above descriptions SV denotes the current set point value for control which is different from SP1 as the ramp function is performed.

There are four types of alarm modes available for each alarm function, these are: Normal alarm, Latching alarm, Holding alarm and Latching/Holding alarm. They are described as follows:

Normal Alarm : ALMD = NORM

When a normal alarm is selected, the alarm output is de-energized in the non-alarm condition and energized in an alarm condition.

Latching Alarm : ALMD = LTCH

If a latching alarm is selected, once the alarm output is energized, it will remain unchanged even if the alarm condition is cleared. The latching alarm is reset when the RESET key is pressed, once the alarm condition is removed.

Holding Alarm : ALMD = HOLD

A holding alarm prevents an alarm from power up. The alarm is enabled only when the alarm condition is removed. Afterwards , the alarm performs same function as normal alarm.

Latching / Holding Alarm : ALMD = LT.HO

A latching / holding alarm performs both holding and latching function. The latching alarm is reset when the RESET key is pressed, once the alarm condition is removed.

Set Point Holding Alarm: ALMD= SP.HO

A set point holding alarm prevents an alarm from power up and / or changing set point. The alarm output is de-energized whenever the set point is changed even if it is in an alarm condition. The alarm reverts to a normal alarm once the alarm condition is removed.

Alarm Failure Transfer is activated as the unit enters **failure mode**.

Alarm will go on if **ON** is set for **ALFT** and go off if **OFF** is set for **ALFT**. The unit will enter failure mode when sensor break occurs or if the A-D converter of the unit fails.

3-5 Configure User Menu

The conventional controllers are designed with a fixed parameters' scrolling. If you need a more friendly operation to suit your application, the vender will say " sorry " to you. The series have the flexibility for you to select those parameters which are most significant to you and put these parameters in the front of display sequence.

SEL1~SEL8 : Selects the parameter for view and change in the user menu.

Range : LOCK, INPT, UNIT, DP, SHIF, PB, TI, TD, O1HY, CYC1, OFST,
RR, O2HY, CYC2, CPB, DB, ADDR, ALHY

When using the up-down key to select the parameters, you may not obtain all of the above parameters. The number of visible parameters is dependent on the setup condition. The hidden parameters for the specific application are also deleted from the SEL selection.

Example :

OUT2 selects DE.LO PB= 100.0 SEL1 selects INPT
SEL2 selects UNIT SEL3 selects PB SEL4 selects TI
SEL5~SEL8 selects NONE Now, the upper display scrolling becomes :

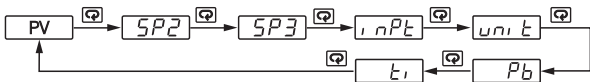

3 - 6 Ramp

The ramping function is performed during power up as well as any time the set point is changed. Choose MINR or HRR for RAMP, the unit will perform the ramping function. The ramp rate is programmed by adjusting RR. The ramping function is disabled as soon as the failure mode, the manual control mode, the auto-tuning mode or the calibration mode occurs.

Example without Dwell Timer

Select MINR for RAMP, selects °C for UNIT, selects 1-DP for DP, Set RR= 10.0. SV is set to 200 °C initially, and changed to 100 °C after 30 minutes since power up. The starting temperature is 30 °C. After power up the process is running like the curve shown below:

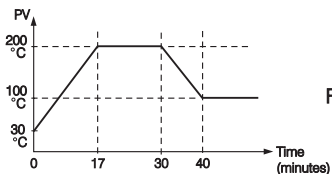

Figure 3.5 RAMP Function

Note: When the ramp function is used, the lower display will show the current ramping value. However it will revert to show the set point value as soon as the up or down key is touched for adjustment. The ramping value is initiated to process value either as power up or RR and /or set point are changed. Setting RR to zero means no ramp function at all.

3-7 Dwell Timer

Alarm output can be configured as dwell timer by selecting TIMR for ALFN . As the dwell timer is configured, the parameter SP3 is used for dwell time adjustment. The dwell time is measured in minute ranging from 0.1 to 4553.6 minutes. Once the process reaches the set point the dwell timer starts to count down until zero (time out). The timer relay will remain unchanged until time out. The dwell timer operation is shown as following diagram.

After time out the dwell timer will be restarted by pressing the RESET key.

The timer stops to count during the manual control mode, failure mode, calibration period and auto-tuning period.

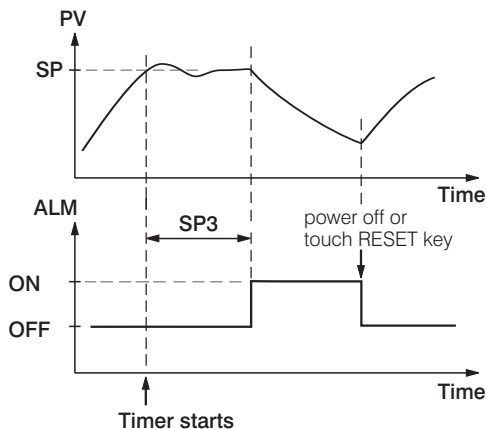

Figure 3.6 Dwell Timer Function

If alarm is configured as dwell timer, ALHY and ALMD are hidden.

3 - 8 PV Shift

In certain applications it is desirable to shift the controller display value from its actual value. This can be easily accomplished by using the PV shift function.

The SHIF function will alter PV only.

Here is an example. A process is equipped with a heater, a sensor and a subject to be warmed up. Due to the design and position of the components in the system, the sensor could not be placed any closer to the part. Thermal gradient (different temperature) is common and necessary to an extent in any thermal system for heat to be transferred from one point to another. If the difference between the sensor and the subject is 35 °C, and the desired temperature at the subject to be heated is 200 °C, the controlling value or the temperature at the sensor should be 235 °C. You should input -35 °C as to subtract 35 °C from the actual process display. This in turn will cause the controller to energize the load and bring the process display up to the set point value.

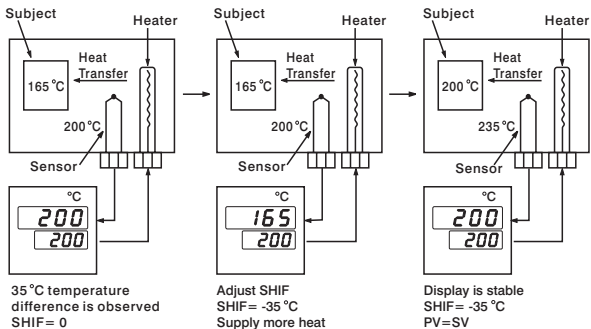

Figure 3.7
PV Shift Application

3-9 Digital Filter

In certain application the process value is too unstable to be read. To improve this a programmable low pass filter incorporated in the controller can be used. This is a first order filter with time constant specified by **FILT** parameter . The default value of **FILT** is 0.5 sec. before shipping. Adjust **FILT** to change the time constant from 0 to 60 seconds. 0 second represents no filter is applied to the input signal. The filter is characterized by the following diagram.

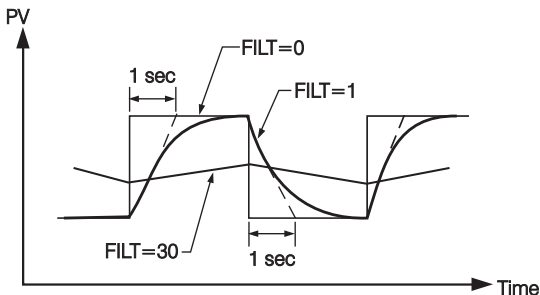

Figure 3.8
Filter Characteristics

Note

The Filter is available only for PV, and is performed for the displayed value only. The controller is designed to use unfiltered signal for control even if Filter is applied. A lagged (filtered) signal, if used for control, may produce an unstable process.

3-10 Failure Transfer

The controller will enter **failure mode** as one of the following conditions occurs:

1. **SBER** occurs due to the input sensor break or input current below 1mA if 4-20 mA is selected or input voltage below 0.25V if 1-5 V is selected .
2. **ADER** occurs due to the A-D converter of the controller fails.

The output 1 and output 2 will perform the **failure transfer** function as the controller enters failure mode.

Output 1 Failure Transfer, if activated, will perform :

1. If output 1 is configured as proportional control ($PB \neq 0$), and BPLS is selected for O1FT, then output 1 will perform bumpless transfer. Thereafter the previous averaging value of MV1 will be used for controlling output 1.
2. If output 1 is configured as proportional control ($PB \neq 0$), and a value of 0 to 100.0 % is set for O1FT, then output 1 will perform failure transfer. Thereafter the value of O1FT will be used for controlling output 1.
3. If output 1 is configured as ON-OFF control ($PB = 0$), then output 1 will transfer to off state if OFF is set for O1FT and transfer to on state if ON is set for O1FT.

Output 2 Failure Transfer, if activated, will perform :

1. If OUT2 is configured as COOL, and BPLS is selected for O2FT, then output 2 will perform bumpless transfer. Thereafter the previous averaging value of MV2 will be used for controlling output 2.
2. If OUT2 is configured as COOL, and a value of 0 to 100.0 % is set for O2FT, then output 2 will perform failure transfer. Thereafter the value of O2FT will be used for controlling output 2.
3. If OUT2 is configured as alarm function, and OFF is set for O2FT, then output 2 will transfer to off state, otherwise, output 2 will transfer to on state if ON is set for O2FT.

Alarm Failure Transfer is activated as the controller enters failure mode. Thereafter the alarm will transfer to the ON or OFF state which is determined by the set value of ALFT.

3-11 Auto-tuning





The auto-tuning process is performed at set point. The process will oscillate around the set point during tuning process. Set a set point to a lower value if overshooting beyond the normal process value is likely to cause damage.

The auto-tuning is applied in cases of :

- * Initial setup for a new process
- * The set point is changed substantially from the previous auto-tuning value
- * The control result is unsatisfactory

Operation :

1. The system has been installed normally.
2. Set the correct values for the setup menu of the unit.
But don't use a zero value for PB and TI , otherwise, the auto-tuning program will be disabled. The LOCK parameter should be set at NONE.
3. Set the set point to a normal operating value or a lower value if overshooting beyond the normal process value is likely to cause damage.
4. Press  and hold until  appears on the display.
5. Press  for at least 5 seconds. The AT indicator will begin to flash and the auto-tuning procedure is beginning.

NOTE :

The ramping function, if used, will be disabled once auto-tuning is proceeding.

The auto-tuning mode is disabled as soon as either failure mode or manual control mode occurs.

Procedures:

The auto-tuning can be applied either as the process is warming up (Cold Start) or as the process has been in steady state (Warm Start).

After the auto-tuning procedures are completed, the AT indicator will cease to flash and the unit revert to PID control by using its new PID values. The PID values obtained are stored in the nonvolatile memory.

ATER Auto-Tuning Error

If auto-tuning fails an ATER message will appear on the upper display in cases of :

- If PB exceeds 9000 (9000 PU, 900.0 °F or 500.0 °C).
- or if TI exceeds 3600 seconds.
- or if set point is changed during auto-tuning procedure.

Solutions to **ATER**

1. Try auto-tuning once again.
2. Don't change set point value during auto-tuning procedure.
3. Don't set zero value for PB and TI.
4. Use manual tuning instead of auto-tuning. (See section 3-12).
5. Touch RESET key to reset **ATER** message.

3 - 12 Manual Tuning

In certain applications (very few) using auto-tuning to tune a process may be inadequate for the control requirement, then you can try manual tuning.

If the control performance by using auto- tuning is still unsatisfactory, the following rules can be applied for further adjustment of PID values :







ADJUSTMENT SEQUENCE	SYMPTOM	SOLUTION
(1) Proportional Band (PB)	Slow Response	Decrease PB
	High overshoot or Oscillations	Increase PB
(2) Integral Time (TI)	Slow Response	Decrease TI
	Instability or Oscillations	Increase TI
(3) Derivative Time (TD)	Slow Response or Oscillations	Decrease TD
	High Overshoot	Increase TD

Table 3.2 PID Adjustment Guide

Figure 3.9 shows the effects of PID adjustment on process response.

3-13 Manual Control

Operation:

To enable manual control the LOCK parameter should be set with NONE, then press  for 6.2 seconds   (Hand Control) will appear on the display. Press  for 5 seconds then the MAN indicator will begin to flash and the lower display will show . The controller now enters the manual control mode.  indicates output control variable for output 1, and  indicates control variable for output 2. Now you can use up-down key to adjust the percentage values for the heating or cooling output.

The controller performs open loop control as long as it stays in manual control mode.

Exit Manual Control

To press  key the controller will revert to its normal display mode.

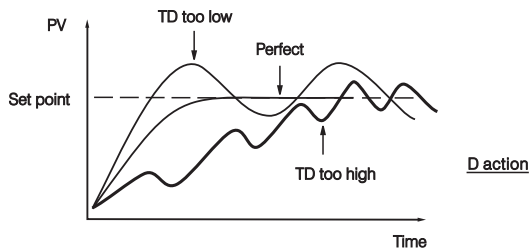
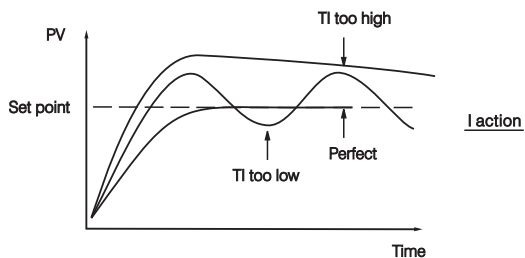
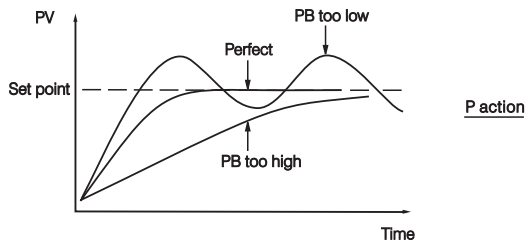

Figure 3.9 Effects of PID Adjustment

3 - 14 Data Communication

The controllers support **RTU** mode of **Modbus** protocol for the data communication. Other protocols are not available for the series.

Two types of interface are available for Data Communication. These are **RS-485** and **RS-232** interface. Since **RS-485** uses a differential architecture to drive and sense signal instead of a single ended architecture which is used for **RS-232**, **RS-485** is less sensitive to the noise and suitable for a longer distance communication. **RS-485** can communicate without error over 1 km distance while **RS-232** is not recommended for a distance over 20 meters.

Using a PC for data communication is the most economic way. The signal is transmitted and received through the PC communication Port (generally **RS-232**). Since a standard PC can't support **RS-485** port, a network adaptor (such as **SNA10A**, **SNA10B**) has to be used to convert **RS-485** to **RS-232** for a PC if **RS-485** is required for the data communication. But there is no need to be sad. Many **RS-485** units (up to 247 units) can be connected to one **RS-232** port, therefore a PC with 4 comm ports can communicate with 988 units. It is quite economic.

Setup

Enters the setup menu.

Select **RTU** for **COMM** . Set individual address as for those units which are connected to the same port.

Set the Baud Rate (**BAUD**), Data Bit (**DATA**), Parity Bit (**PARI**) and Stop Bit (**STOP**) such that these values are accordant with PC setup conditions.

If you use a conventional 9-pin RS-232 cable instead of CC94-1, the cable should be modified for proper operation of RS-232 communication according to Section 2-9.

3-15 PV Retransmission

The controller can output (retransmit) process value via its retransmission terminals **RE+** and **RE-** provided that the retransmission option is ordered. A correct signal type should be selected for **COMM** parameter to meet the retransmission option installed. **RELO** and **REHI** are adjusted to specify the low scale and high scale values of retransmission.

Chapter 4 Applications

4 - 1 Heat Only Control with Dwell Timer

An oven is designed to dry the products at 150 °C for 30 minutes and then stay unpowered for another batch. A B41 equipped with **dwell timer** is used for this purpose. The system diagram is shown as follows :

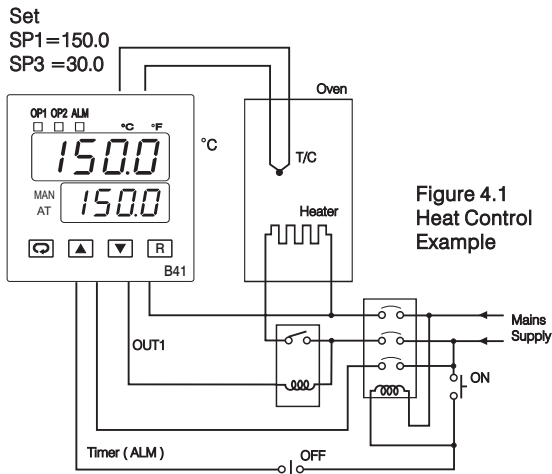

Figure 4.1
Heat Control
Example

To achieve this function set the following parameters in the setup menu.

INPT=K_TC

UNIT= °C

DP=1_DP

OUT1=REVR

O1TY=RELY

CYC1=18.0

O1FT=BPLS

ALFN=TIMR

ALFT=ON

Auto-Tuning is performed at 150 °C for a new oven.

4 - 2 Cool Only Control

A BTC-8100 is used to control a refrigerator at temperature below 0 °C. The temperature is lower than the ambient, a cooling action is required. Hence select DIRT for OUT1. Since output 1 is used to drive a magnetic contactor, O1TY selects RELY. A small temperature oscillation is tolerable, hence use ON-OFF control to reduce the overall cost. To achieve ON-OFF control, PB is set with zero and O1HY is set at 0.1 °C.

Setup Summary:

INPT=PT.DN

UNIT= °C

DP=1-DP

OUT1=DIRT

O1TY=RELY

User Menu:

PB = 0 (°C)

O1HY=0.1 (°C)

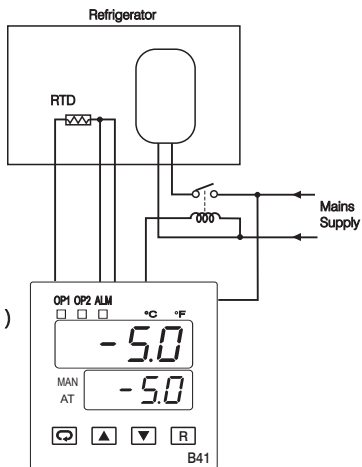

Figure 4.2
Cooling Control Example

4 - 3 Heat-Cool Control

An injection mold required to be controlled at 120 °C to ensure a consistent quality for the parts. An oil pipe is buried in the mold. Since plastics is injected at higher temperature (e.g. 250 °C), the circulation oil needs to be cooled as its temperature rises. Here is an example:

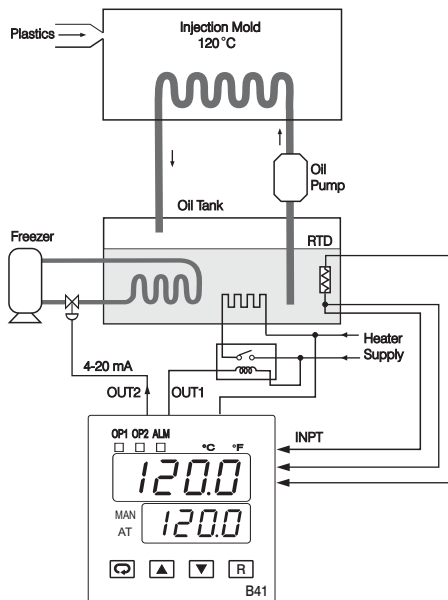

Figure 4.3
Heat-Cool Control Example

The PID Heat-Cool is used for the above example.
To achieve this set the following parameters in the Setup Menu:

```
INPT=PT.DN
UNIT= °C
DP= 1-DP
OUT1=REVR
O1TY=RELY
CYC1=18.0 (sec.)
O1FT=BPLS
OUT2=COOL
O2TY=4-20
O2FT=BPLS
```

Adjust SV at 120.0 °C , CPB at 125 (%) and DB at -4.0 (%).
Apply Auto-tuning at 120 °C for a new system to get an optimal PID values. See Section 3-11.

Adjustment of CPB is related to the cooling media used. If water is used as cooling media instead of oil, the CPB is set at 250 (%). If air is used as cooling media instead of oil, the CPB is set at 100 (%).
Adjustment of DB is dependent on the system requirements. More positive value of DB will prevent unwanted cooling action, but will increase the temperature overshoot, while more negative value of DB will achieve less temperature overshoot, but will increase unwanted cooling action.

Chapter 5 Calibration

 Do not proceed through this section unless there is a definite need to re-calibrate the controller. Otherwise, all previous calibration data will be lost. Do not attempt recalibration unless you have appropriate calibration equipment. If calibration data is lost, you will need to return the controller to your supplier who may charge you a service fee to re-calibrate the controller.

 Entering calibration mode will break the control loop. Make sure that if the system is allowable to apply calibration mode.

Equipments needed before calibration:

- (1) A high accuracy calibrator (Fluke 5520A Calibrator recommended) with following functions:
 - 0 - 100 mV millivolt source with ± 0.005 % accuracy
 - 0 - 10 V voltage source with ± 0.005 % accuracy
 - 0 - 20 mA current source with ± 0.005 % accuracy
 - 0 - 300 ohm resistant source with ± 0.005 % accuracy
- (2) A test chamber providing 25 °C - 50 °C temperature range
- (3) A switching network (SWU16K, optional for automatic calibration)
- (4) A calibration fixture equipped with programming units (optional for automatic calibration)
- (5) A PC installed with calibration software BC-Net and Smart Network Adaptor SNA10B (optional for automatic calibration)

The calibration procedures described in the following section are a step by step **manual procedures**.

Since it needs 30 minutes to warm up an unit before calibration, calibrating the unit one by one is quite inefficient. An **automatic calibration system** for small quantity as well as for unlimited quantity is available upon request.

Manual Calibration Procedures

- * Perform step 1 to enter calibration mode.

Step 1. Set the Lock parameter to the unlocked condition (LOCK= NONE).

Press and hold the scroll key until **Cal** appears on the display, then release the scroll key.

Press the scroll key for 2 seconds then release, the display will show **AdLo** and the unit enters calibration mode .

- * Perform step 2 to calibrate Zero of A to D converter and step 3 to calibrate gain of A to D converter.

Step 2. Short the thermocouple inpt terminals , then press scroll key for at least 5 seconds. The display will blink a moment and a new value is obtained. Otherwise, if the display didn't blink or if the obtained value is equal to -199.9 or 199.9, then the calibration fails.

Step 3. Press scroll key until the display shows **AdHi** . Send a 60 mV signal to the thermocouple input terminals in correct polarity . Press scroll key for at least 5 seconds . The display will blink a moment and a new value is obtained . Otherwise , if the display didn't blink or if the obtained value is equal to -199.9 or 199.9, then the calibration fails.

- * Perform both steps 4 and 5 to calibrate RTD function (if required) for input .

Step 4. Press scroll key until the display shows \boxed{rtdL} . Send a 100 ohms signal to the RTD input terminals according to the connection shown below:

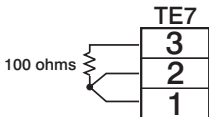

Figure 5.1 RTD Calibration

Press scroll key for at least 5 seconds . The display will blink a moment, otherwise the calibration fails.

Step 5. Press scroll key and the display will show \boxed{rtdH} . Change the ohm's value to 300 ohms .Press scroll key for at least 5 seconds. The display will blink a moment and two values are obtained for RTDH and RTDL (step 4). Otherwise, if the display didn't blink or if any value obtained for RTDH and RTDL is equal to -199.9 or 199.9 , then the calibration fails.

* Perform step 6 to calibrate offset of cold junction compensation , if required.

Step 6. Setup the equipments according to the following diagram for calibrating the cold junction compensation. Note that a K type thermocouple must be used.

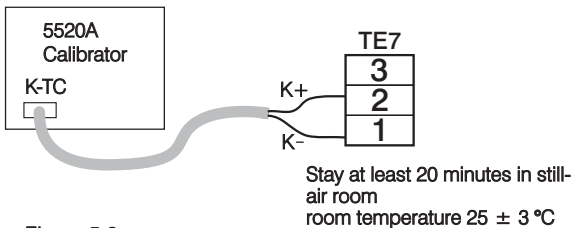

Figure 5.2
Cold Junction Calibration Setup

The 5520A calibrator is configured as K type thermocouple output with internal compensation. Send a $0.00 \text{ }^{\circ}\text{C}$ signal to the unit under calibration.

The unit under calibration is powered in a still-air room with temperature $25 \pm 3 \text{ }^{\circ}\text{C}$. Stay at least 20 minutes for warming up. Perform step 1 stated above, then press scroll key until the display shows $\boxed{[JLo]}$. Press up/down key to obtain 40.00.

Press scroll key for at least 5 seconds. The display will blink a moment and a new value is obtained. Otherwise, if the display didn't blink or if the obtained value is equal to -5.00 or 40.00 , then the calibration fails.

*Perform step 7 to calibrate **gain of cold junction** compensation if required.

Step 7. Setup the equipments same as step 6. The unit under calibration is powered in a still-air room with temperature **$50 \pm 3 \text{ }^{\circ}\text{C}$** . Stay at least 20 minutes for warming up. The calibrator source is set at $0.00 \text{ }^{\circ}\text{C}$ with internal compensation mode.

Perform step 1 stated above , then press scroll key until the display shows $\boxed{C_{JH}}$. Press scroll key for at least 5 seconds. The display will blink a moment and a new value is obtained. Otherwise , if the display didn't blink or if the obtained value is equal to -199.9 or 199.9, then the calibration fails.

This setup is performed in a **high temperature chamber**, hence it is recommended to use a computer to perform the procedures.

★ **Input modification and recalibration** procedures for a **linear voltage** or a **linear current** input:

1. Remove R60(3.3K) and install two 1/4 W resistors RA and RB on the control board with the recommended values specified in the following table.

The low temperature coefficient resistors should be used for RA and RB.

Input Function	RA	RB	R60
T/C, RTD, 0~60mV	X	X	3.3K
0 ~ 1 V	61.9K	3.92K	X
0 ~ 5V, 1 ~ 5V	324K	3.92K	X
0 ~ 10 V	649K	3.92K	X
0~20mA, 4~20mA	39Ω	3.01Ω	X

2. Perform **Step 1** and **Step 2** to calibrate the linear input zero.
3. Perform **Step 3** but send a span signal to the input terminals instead of 60mV. The span signal is 1V for 0~1V input, 5V for 0~5V or 1~5V input, 10V for 0~10V input and 20mA for 0~20mA or 4~20mA input.

★ **Final step**

Step 8. Set the LOCK value to your desired function.

Chapter 6 Specifications

Power

90–250 VAC, 47–63 Hz, 12VA, 5W maximum

11–26 VAC / VDC, SELV, Limited Energy, 12VA, 5W maximum

Input

Resolution : 18 bits

Sampling Rate : 5 times / second

Maximum Rating : -2 VDC minimum, 12 VDC maximum
(1 minute for mA input)

Temperature Effect : $\pm 1.5\mu\text{V}/^\circ\text{C}$ for all inputs except
mA input
 $\pm 3.0\mu\text{V}/^\circ\text{C}$ for mA input

Sensor Lead Resistance Effect :

T/C: $0.2\mu\text{V}/\text{ohm}$

3-wire RTD: $2.6^\circ\text{C}/\text{ohm}$ of resistance difference of two
leads

2-wire RTD: $2.6^\circ\text{C}/\text{ohm}$ of resistance sum of two leads

Burn-out Current : 200 nA

Common Mode Rejection Ratio (CMRR): 120dB

Normal Mode Rejection Ratio (NMRR): 55dB

Sensor Break Detection :

Sensor open for TC, RTD and mV inputs,

Sensor short for RTD input

below 1 mA for 4-20 mA input,

below 0.25V for 1 - 5 V input,

unavailable for other inputs.

Sensor Break Responding Time :

Within 4 seconds for TC, RTD and mV inputs,

0.1 second for 4-20 mA and 1 - 5 V inputs.

Characteristics:

Type	Range	Accuracy @ 25 °C	Input Impedance
J	-120°C-1000°C (-184°F -1832°F)	±2 °C	2.2 MΩ
K	-200°C -1370°C (-328°F -2498°F)	±2 °C	2.2 MΩ
T	-250°C -400°C (-418°F -752°F)	±2 °C	2.2 MΩ
E	-100°C -900°C (-148°F -1652°F)	±2 °C	2.2 MΩ
B	0°C -1800°C (32 °F - 3272 °F)	±2 °C (200°C - 1800°C)	2.2 MΩ
R	0°C -1767.8°C (32 °F -3214 °F)	±2 °C	2.2 MΩ
S	0°C -1767.8°C (32 °F - 3214 °F)	±2 °C	2.2 MΩ
N	-250°C -1300°C (-418°F -2372°F)	±2 °C	2.2 MΩ
L	-200°C -900°C (-328°F -1652°F)	±2 °C	2.2 MΩ
PT100 (DIN)	-210°C -700°C (-346°F -1292°F)	±0.4 °C	1.3 KΩ
PT100 (JIS)	-200°C -600°C (-328°F -1112°F)	±0.4 °C	1.3 KΩ
mV	-8mV - 70mV	±0.05 %	2.2 MΩ
mA	-3mA -27mA	±0.05 %	70.5 Ω
V	-1.3V -11.5V	±0.05 %	650 KΩ

Output 1 / Output 2

Relay Rating : 2A/240 VAC, life cycles 200,000 for resistive load

Pulsed Voltage : Source Voltage 5V,
current limiting resistance 66 Ω .

Linear Output Characteristics

Type	Zero Tolerance	Span Tolerance	Load Capacity
4~20 mA	3.6~4 mA	20~21 mA	500 Ω max.
0~20 mA	0 mA	20~21 mA	500 Ω max.
0 ~ 5 V	0 V	5 ~ 5.25 V	10 K Ω min.
1 ~ 5 V	0.9 ~ 1 V	5 ~ 5.25 V	10 K Ω min.
0 ~ 10 V	0 V	10 ~10.5 V	10 K Ω min.

Linear Output

Resolution : 15 bits

Output Regulation : 0.02 % for full load change

Output Settling Time : 0.1 sec. (stable to 99.9 %)

Isolation Breakdown Voltage : 1000 VAC

Temperature Effect : ± 0.01 % of SPAN / $^{\circ}\text{C}$

Triac (SSR) Output

Rating : 1A / 240 VAC

Inrush Current : 20A for 1 cycle

Min. Load Current : 50 mA rms

Max. Off-state Leakage : 3 mA rms

Max. On-state Voltage : 1.5 V rms

Insulation Resistance : 1000 Mohms min. at 500 VDC

Dielectric Strength : 2500 VAC for 1 minute

DC Voltage Supply Characteristics (Installed at Output 2)

Type	Tolerance	Max. Output Current	Ripple Voltage	Isolation Barrier
20 V	± 1 V	25 mA	0.2 Vp-p	500 VAC
12 V	± 0.6 V	40 mA	0.1 Vp-p	500 VAC
5 V	± 0.25 V	80 mA	0.05 Vp-p	500 VAC

Alarm

Alarm Relay : Form C Rating

2A/240VAC, life cycles 200,000 for resistive load.

Alarm Functions : Dwell timer, Deviation High / Low Alarm,
Deviation Band High / Low Alarm,
PV High / Low Alarm,

Alarm Mode : Normal, Latching, Hold, Latching / Hold.

Dwell Timer : 0.1 - 4553.6 minutes

Data Communication

Interface : RS-232 (1 unit), RS-485 (up to 247 units)

Protocol : Modbus Protocol RTU mode

Address : 1 - 247

Baud Rate : 2.4 ~ 38.4 Kbits/sec

Data Bits : 7 or 8 bits

Parity Bit : None, Even or Odd

Stop Bit : 1 or 2 bits

Communication Buffer : 160 bytes

Analog Retransmission

Output Signal : 4-20 mA, 0-20 mA, 0 - 5V,
1 - 5V, 0 - 10V

Resolution : 15 bits

Accuracy : ±0.05 % of span ±0.0025 %/ °C

Load Resistance :

0 - 500 ohms (for current output)

10 K ohms minimum (for voltage output)

Output Regulation : 0.01 % for full load change

Output Settling Time : 0.1 sec. (stable to 99.9 %)
Isolation Breakdown Voltage : 1000 VAC min.
Integral Linearity Error : ± 0.005 % of span
Temperature Effect : ± 0.0025 % of span/ $^{\circ}\text{C}$
Saturation Low : 0 mA (or 0V)
Saturation High : 22.2 mA (or 5.55V, 11.1V min.)
Linear Output Range : 0-22.2mA(0-20mA or 4-20mA)
0-5.55V (0 - 5V, 1 - 5V)
0 - 11.1 V (0 - 10V)

User Interface

Dual 4-digit LED Displays
Keypad : 4 keys
Programming Port : For automatic setup, calibration and testing
Communication Port : Connection to PC for supervisory control

Control Mode

Output 1 : Reverse (heating) or direct (cooling) action
Output 2 : PID cooling control, cooling P band 50~300%
of PB, dead band -36.0 ~ 36.0 % of PB
ON-OFF : 0.1 - 90.0 ($^{\circ}\text{F}$) hysteresis control (P band = 0)
P or PD : 0 - 100.0 % offset adjustment
PID : Fuzzy logic modified
Proportional band 0.1 ~ 900.0 $^{\circ}\text{F}$.
Integral time 0 - 3600 seconds
Derivative time 0 - 360.0 seconds
Cycle Time : 0.1 - 90.0 seconds
Manual Control : Heat (MV1) and Cool (MV2)
Auto-tuning : Cold start and warm start
Failure Mode : Auto-transfer to manual mode while
sensor break or A-D converter damage
Ramping Control : 0 - 900.0 $^{\circ}\text{F}/\text{minute}$ or
0 - 900.0 $^{\circ}\text{F}/\text{hour}$ ramp rate

Digital Filter

Function : First order
Time Constant : 0, 0.2, 0.5, 1, 2, 5, 10, 20, 30, 60
seconds programmable

Environmental & Physical

Operating Temperature : -10 °C to 50 °C

Storage Temperature : -40 °C to 60 °C

Humidity : 0 to 90 % RH (non-condensing)

Altitude: 2000m maximum

Pollution: Degree 2

Insulation Resistance : 20 Mohms min. (at 500 VDC)

Dielectric Strength : 2000 VAC, 50/60 Hz for 1 minute

Vibration Resistance : 10 - 55 Hz, 10 m/s² for 2 hours

Shock Resistance : 200 m/s² (20 g)

EMC: EN61326

Chapter 7 Modbus Communications

This chapter specifies the Modbus Communications protocol as RS-232 or RS-485 interface module is installed. Only RTU mode is supported. Data is transmitted as eight-bit binary bytes with 1 start bit, 1 stop bit and optional parity checking (None, Even or Odd). Baud rate may be set to 2400, 4800, 9600, 14400, 19200, 28800 and 38400.

7-1 Functions Supported

Only function 03, 06 and 16 are available for this series of controllers. The message formats for each function are described as follows:

Function 03: Read Holding Registers

Query (from master)	Response (from slave)
Slave address (0-255)	←
Function code (3)	←
Starting address of register Hi (0)	Byte count
Starting address of register Lo (0-79, 128-131)	Data 1 Hi
	Data 1 Lo
No. of words Hi (0)	Data 2 Hi
No. of words Lo (1-79)	Data 2 Lo
CRC16 Hi	⋮
CRC16 Lo	⋮
	CRC16 Hi
	CRC16 Lo

Function 06: Preset single Register

Query (from master)	Response (from slave)
Slave address (0-255)	←
Function code (6)	←
Register address Hi (0)	←
Register address Lo (0-79, 128-131)	←
Data Hi	←
Data Lo	←
CRC16 Hi	←
CRC16 Lo	←

Function 16: Preset Multiple Registers

Query (from master)	Response (from slave)
Slave address (0-255)	←
Function code (16)	←
Starting address of register Hi (0)	←
Starting address of register Lo (0-79, 128-131)	←
No. of words Hi (0)	←
No. of words Lo (1-79)	←
Byte count (2-158)	CRC16 Hi
Data 1 Hi	CRC16 Lo
Data 1 Lo	
Data 2 Hi	
Data 2 Lo	
•	
•	
•	
•	
CRC16 Hi	
CRC16 Lo	

7-2 Exception Responses

If the controller receives a message which contains a corrupted character (parity check error, framing error etc.), or if the CRC16 check fails, the controller ignores the message.

However, if the controller receives a syntactically correct message which contains an illegal value, it will send an exception response, consisting of five bytes as follows:

slave address + offset function code + exception code + CRC16 Hi + CRC16 Lo

Where the offset function code is obtained by adding the function code with 128 (ie. function 3 becomes H'83), and the exception code is equal to the value contained in the following table:

Exception Code	Name	Cause
1	Bad function code	Function code is not supported by the controller
2	Illegal data address	Register address out of range
3	Illegal data value	Data value out of range or attempt to write a read-only or protected data

7-3 Parameter Table

Register Address	Parameter Notation	Parameter	Scale Low	Scale High	Notes
0	SP1	Set point 1	*4	*4	R/W
1	SP2	Set point 2	*7	*7	R/W
2	SP3	Set point 3	*6	*6	R/W
3	LOCK	Lock code	0	65535	R/W
4	INPT	Input sensor selection	0	65535	R/W
5	UNIT	Measuring unit	0	65535	R/W
6	DP	Decimal point position	0	65535	R/W
7	INLO	Low scale value for linear input	*4	*4	R/W
8	INHI	High scale value for linear input	*4	*4	R/W
9	SP1L	Low limit of SP1	*4	*4	R/W
10	SP1H	High limit of SP1	*4	*4	R/W
11	SHIF	PV shift value	*4	*4	R/W
12	FILT	Filter time constant	0	65535	R/W
13	DISP	Display form (for C21)	0	65535	R/W
14	PB	P (proportional) band	*5	*5	R/W
15	TI	Integral time	0	65535	R/W
16	TD	Derivative time	0.0	6553.5	R/W
17	OUT1	Output 1 function	0	65535	R/W
18	O1TY	Output 1 signal type	0	65535	R/W
19	O1FT	Output 1 failure transfer	-1999.9	4553.6	R/W
20	O1HY	Output 1 ON-OFF hysteresis	*5	*5	R/W
21	CYC1	Output 1 cycle time	0.0	6553.5	R/W
22	OFST	Offset value for P control	0.0	6553.5	R/W
23	RAMP	Ramp function	0	65535	R/W
24	RR	Ramp rate	*5	*5	R/W
25	OUT2	Output 2 function	0	65535	R/W
26	RELO	Retransmission low scale value	*4	*4	R/W
27	O2TY	Output 2 signal type	0	65535	R/W
28	O2FT	Output 2 failure transfer	-1999.9	4553.6	R/W
29	O2HY	Output 2 ON-OFF hysteresis	*5	*5	R/W

Register Address	Parameter Notation	Parameter	Scale Low	Scale High	Notes
30	CYC2	Output 2 cycle time	0.0	6553.5	R/W
31	CPB	Cooling P band	0	65535	R/W
32	DB	Heating-cooling dead band	-1999.9	4553.6	R/W
33	ALFN	Alarm function	0	65535	R/W
34	REHI	Retransmission high scale value	*4	*4	R/W
35	ALMD	Alarm operation mode	0	65535	R/W
36	ALHY	Alarm hysteresis	*5	*5	R/W
37	ALFT	Alarm failure transfer	0	65535	R/W
38	COMM	Communication function	0	65535	R/W
39	ADDR	Address	0	65535	R/W
40	BAUD	Baud rate	0	65535	R/W
41	DATA	Data bit count	0	65535	R/W
42	PARI	Parity bit	0	65535	R/W
43	STOP	Stop bit count	0	65535	R/W
44	SEL1	Selection 1	0	65535	R/W
45	SEL2	Selection 2	0	65535	R/W
46	SEL3	Selection 3	0	65535	R/W
47	SEL4	Selection 4	0	65535	R/W
48	SEL5	Selection 5	0	65535	R/W
49	SEL6	Selection 6	0	65535	R/W
50	SEL7	Selection 7	0	65535	R/W
51	SEL8	Selection 8	0	65535	R/W
52	ADLO	mV calibration low coefficient	-1999.9	4553.6	R/W
53	ADHI	mV calibration high coefficient	-1999.9	4553.6	R/W
54	RTDL	RTD calibration low coefficient	-1999.9	4553.6	R/W
55	RTDH	RTD calibration high coefficient	-1999.9	4553.6	R/W
56	CJLO	Cold junction calibration low coefficient	-199.99	455.36	R/W
57	CJHI	Cold junction calibration high coefficient	-1999.9	4553.6	R/W
58	DATE	Date Code	0	65535	R/W
59	SRNO	Serial Number	0	65535	R/W
60	HOUR	Working hours of the controller	0	65535	R/W

Register Address	Parameter Notation	Parameter	Scale Low	Scale High	Notes
61	BPL1	Bumpless transfer of OP1	0.00	655.35	R
62	BPL2	Bumpless transfer of OP2	0.00	655.35	R
63	CJCL	Cold junction signal low	0.000	65.535	R
64, 128	PV	Process value	*4	*4	R
65, 129	SV	Current set point value	*4	*4	R
66 130	MV1	OP1 control output value	0.00	655.35	Read only, unless in manual control
67 131	MV2	OP2 control output value	0.00	655.35	Read only, unless in manual control
68	TIMER	Remaining time of dwell timer	-1999.9	4553.6	R
69	EROR	Error code *1	0	65535	R
70	MODE	Operation mode & alarm status *2	0	65535	R
71, 140	PROG	Program code *3	0.00	655.35	R
72	CMND	Command code	0	65535	R/W
73	JOB1	Job code	0	65535	R/W
74	JOB2	Job code	0	65535	R/W
75	JOB3	Job code	0	65535	R/W
76	CJCT	Cold Junction Temperature	-199.99	455.36	R
77		Reserved	0	65535	R
78		Reserved	0	65535	R
79		Reserved	0	65535	R

*1: The error code is show in the first column of Table A.1.

*2: Definition for the value of MODE register

H'000X = Normal mode

H'010X = Calibration mode

H'020X = Auto-tuning mode

H'030X = Manual control mode

H'040X = Failure mode

H'0X00 = Alarm status is off

H'0x01 = Alarm status is on

The alarm status is shown in MV2 instead of MODE for models C21 and C91.

*3: The PROG Code is defined in the following table:

Model No.	BTC-9100	BTC-8100	BTC-4100	BTC-7100	C21	C91
PROG Code	6.XX	11.XX	12.XX	13.XX	33.XX	34.XX

Where XX denotes the software version number. For example:
 PROG=34.18 means that the controller is C91 with software version 18.

*4: The scale high/low values are defined in the following table for SP1, INLO, INHI, SP1L, SP1H, SHIF, PV, SV, RELO and REHI:

Conditions	Non-linear input	Linear input DP = 0	Linear input DP = 1	Linear input DP = 2	Linear input DP = 3
Scale low	-1999.9	-19999	-1999.9	-199.99	-19.999
Scale high	4553.6	45536	4553.6	455.36	45.536

*5: The scale high/low values are defined in the following table for PB, O1HY, RR, O2HY and ALHY:

Conditions	Non-linear input	Linear input DP = 0	Linear input DP = 1	Linear input DP = 2	Linear input DP = 3
Scale low	0.0	0	0.0	0.00	0.000
Scale high	6553.5	65535	6553.5	655.35	65.535

*6: The scale high/low values are defined in the following table for SP3:

Conditions	ALFN=1 (TIMR)	Non-linear input	Linear input DP = 0	Linear input DP = 1	Linear input DP = 2	Linear input DP = 3
Scale low	-1999.9	-1999.9	-19999	-1999.9	-199.99	-19.999
Scale high	4553.6	4553.6	45536	4553.6	455.36	45.536

*7: The scale high/low values are defined in the following table for SP2:

Conditions	OUT2=1 (TIMR)	Non-linear input	Linear input DP = 0	Linear input DP = 1	Linear input DP = 2	Linear input DP = 3
Scale low	-1999.9	-1999.9	-19999	-1999.9	-199.99	-19.999
Scale high	4553.6	4553.6	45536	4553.6	455.36	45.536

Conditions	Non-linear input	Linear input DP = 0	Linear input DP = 1	Linear input DP = 2	Linear input DP = 3
Scale low	-1999.9	-19999	-1999.9	-199.99	-19.999
Scale high	4553.6	45536	4553.6	455.36	45.536

7-4 Data Conversion

The word data are regarded as unsigned (positive) data in the Modbus message. However, the actual value of the parameter may be negative value with decimal point. The high/low scale values for each parameter are used for the purpose of such conversion.

- Let M = Value of Modbus message
 A = Actual value of the parameter
 SL = Scale low value of the parameter
 SH = Scale high value of the parameter

The conversion formulas are as follows:

$$M = \frac{65535}{SH-SL} \cdot (A - SL)$$

$$A = \frac{SH-SL}{65535} \cdot M + SL$$

7-5 Communication Examples :

Example 1: Down load the default values via the programming port

The programming port can perform Modbus communications regardless of the incorrect setup values of address, baud, parity, stop bit etc. It is especially useful during the first time configuration for the controller. The host must be set with 9600 baud rate, 8 data bits, even parity and 1 stop bit.

The Modbus message frame with hexadecimal values is shown as follows:

01	10	00	00	00	34	68	4F	19	4E	83	4E	83
Addr.	Func.	Starting Addr.		No. of words		Bytes	SP1=25.0		SP2=10.0		SP3=10.0	

00	00	00	01	00	00	00	01	4D	6D	51	C4
LOCK=0		INPT=1		UNIT=0		DP=1		INLO=-17.8		INHI=93.3	

4D	6D	63	21	4E	1F	00	02	00	00	00	64
SP1L=-17.8		SP1H=537.8		SHIF=0.0		FILT=2		DISP=0		PB=10.0	

00	64	00	FA	00	00	00	00	4E	1F	00	01
TI=100		TD=25.0		OUT1=0		O1TY=0		O1FT=0		O1HY=0.1	

00	B4	00	FA	00	00	00	00	00	02	4E	1F
CYC1=18.0		OFST=25.0		RAMP=0		RR=0.0		OUT2=2		RELO=0.0	

00	00	4E	1F	00	01	00	B4	00	64	4E	1F
O2TY=0		O2FT=0		O2HY=0.1		CYC2=18.0		CPB=100		DB=0	

00	02	52	07	00	00	00	01	00	00	00	01
ALFN=2		REHI=100.0		ALMD=0		ALHY=0.1		ALFT=0		COMM=1	

00	01	00	02	00	01	00	00	00	00	00	02
ADDR=1		BAUD=2		DATA=1		PARI=0		STOP=0		SEL1=2	

00	03	00	04	00	06	00	07	00	08	00	0A
SEL2=3		SEL3=4		SEL4=6		SEL5=7		SEL6=8		SEL7=10	

00	11	Hi	Lo
SEL8=17		CRC16	

Example 2: Read PV, SV, MV1 and MV2.

Send the following message to the controller via the COMM port or programming port:

	03	00	H'40 H'80	00	04	Hi	Lo
Addr.	Func.	Starting Addr.	No. of words		CRC16		

Example 3: Perform Reset Function (same effect as pressing **R key)**

Query

	06	00	H'48	H'68	H'25	Hi	Lo
Addr.	Func.	Register Addr.	Data Hi/Lo		CRC16		

Example 4: Enter Auto-tuning Mode

Query

	06	00	H'48	H'68	H'28	Hi	Lo
Addr.	Func.	Register Addr.	Data Hi/Lo		CRC16		

Example 5: Enter Manual Control Mode

Query

	06	00	H'48	H'68	H'27	Hi	Lo
Addr.	Func.	Register Addr.	Data Hi/Lo		CRC16		

Example 6: Read All Parameters

Query

	03	00	00	00	H'50	Hi	Lo
Addr.	Func.	Starting Addr.	No. of words		CRC16		

Example 7: Modify the Calibration Coefficient

Preset the CMND register with 26669 before attempting to change the calibration coefficient.

	06	00	H'48	H'68	H'29	Hi	Lo
Addr.	Func.	Register Addr.	Data Hi / Lo		CRC16		

Table A.1 Error Codes and Corrective Actions

Error Code	Display Symbol	Error Description	Corrective Action
4	<i>Er04</i>	Illegal setup values been used: Before COOL is used for OUT2, DIRT (cooling action) has already been used for OUT1, or PID mode is not used for OUT1 (that is PB = 0, and / or TI = 0)	Check and correct setup values of OUT2, PB, TI and OUT1. IF OUT2 is required for cooling control, the control should use PID mode (PB ≠ 0, TI ≠ 0) and OUT1 should use reverse mode (heating action) , otherwise, don't use OUT2 for cooling control.
10	<i>Er10</i>	Communication error: bad function code	Correct the communication software to meet the protocol requirements.
11	<i>Er11</i>	Communication error: register address out of range	Don't issue an over-range register address to the slave.
14	<i>Er14</i>	Communication error: attempt to write a read-only data or a protected data	Don't write a read-only data or a protected data to the slave.
15	<i>Er15</i>	Communication error: write a value which is out of range to a register	Don't write an over-range data to the slave register.
26	<i>RtEr</i>	Fail to perform auto-tuning function	<ol style="list-style-type: none"> 1.The PID values obtained after auto-tuning procedure are out of range. Retry auto-tuning. 2.Don't change set point value during auto-tuning procedure. 3.Use manual tuning instead of auto-tuning. 4. Don't set a zero value for PB. 5. Don't set a zero value for TI. 6. Touch RESET key
29	<i>EEPE</i>	EEPROM can't be written correctly	Return to factory for repair.
30	<i>CJEr</i>	Cold junction compensation for thermocouple malfunction	Return to factory for repair.
39	<i>SbEr</i>	Input sensor break, or input current below 1 mA if 4-20 mA is selected, or input voltage below 0.25V if 1 - 5V is selected	Replace input sensor.
40	<i>RdEr</i>	A to D converter or related component(s) malfunction	Return to factory for repair.

WARRANTY

Brainchild Electronic Co. is pleased to offer suggestions on the use of its various products. However, Brainchild makes no warranties or representations of any sort regarding the fitness for use, or the application of its products by the Purchaser. The selection, application or use of Brainchild products is the Purchaser's responsibility. No claims will be allowed for any damages or losses, whether direct, indirect, incidental, special or consequential. Specifications are subject to change without notice. In addition, Brainchild reserves the right to make changes-without notification to Purchaser-to materials or processing that do not affect compliance with any applicable specification. Brainchild products are warranted to be free from defects in material and workmanship for two years after delivery to the first purchaser for use. An extended period is available with extra cost upon request. Brainchild's sole responsibility under this warranty, at Brainchild's option, is limited to replacement or repair, free of charge, or refund of purchase price within the warranty period specified. This warranty does not apply to damage resulting from transportation, alteration, misuse or abuse.

RETURNS

No products return can be accepted without a completed Return Material Authorization (RMA) form.

Bc BRAINCHILD Electronic Co., Ltd.

No.209, Chung Yang Rd., Nan Kang Dist.,
Taipei, Taiwan, R.O.C. 115

Tel: 886-2-27861299

Fax: 886-2-27861395

web site: <http://www.brainchild.com.tw>