



UA



CRX-330

*CD RECEIVER
AMPLI-TUNER CD*

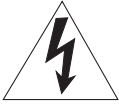

OWNER'S MANUAL
MODE D'EMPLOI

IMPORTANT SAFETY INSTRUCTIONS

	CAUTION RISK OF ELECTRIC SHOCK DO NOT OPEN	
---	---	---

CAUTION: TO REDUCE THE RISK OF ELECTRIC SHOCK, DO NOT REMOVE COVER (OR BACK). NO USER-SERVICEABLE PARTS INSIDE. REFER SERVICING TO QUALIFIED SERVICE PERSONNEL.

• Explanation of Graphical Symbols



The lightning flash with arrowhead symbol, within an equilateral triangle, is intended to alert you to the presence of uninsulated "dangerous voltage" within the product's enclosure that may be of sufficient magnitude to constitute a risk of electric shock to persons.



The exclamation point within an equilateral triangle is intended to alert you to the presence of important operating and maintenance (servicing) instructions in the literature accompanying the appliance.

Note to CATV system installer:

This reminder is provided to call the CATV system installer's attention to Article 820-40 of the NEC that provides guidelines for proper grounding and, in particular, specifies that the cable ground shall be connected to the grounding system of the building, as close to the point of cable entry as practical.

IMPORTANT

Please record the serial number of this unit in the space below.

MODEL:

Serial No.:

The serial number is located on the rear of the unit. Retain this Owner's Manual in a safe place for future reference.

- 1 Read these instructions.
- 2 Keep these instructions.
- 3 Heed all warnings.
- 4 Follow all instructions.
- 5 Do not use this apparatus near water.
- 6 Clean only with dry cloth.
- 7 Do not block any ventilation openings. Install in accordance with the manufacturer's instructions.
- 8 Do not install near any heat sources such as radiators, heat registers, stoves, or other apparatus (including amplifiers) that produce heat.
- 9 Do not defeat the safety purpose of the polarized or grounding-type plug. A polarized plug has two blades with one wider than the other. A grounding type plug has two blades and a third grounding prong. The wide blade or the third prong are provided for your safety. If the provided plug does not fit into your outlet, consult an electrician for replacement of the obsolete outlet.
- 10 Protect the power cord from being walked on or pinched particularly at plugs, convenience receptacles, and the point where they exit from the apparatus.
- 11 Only use attachments/accessories specified by the manufacturer.
- 12 Use only with the cart, stand, tripod, bracket, or table specified by the manufacturer, or sold with the apparatus. When a cart is used, use caution when moving the cart/apparatus combination to avoid injury from tip-over.
- 13 Unplug this apparatus during lightning storms or when unused for long periods of time.
- 14 Refer all servicing to qualified service personnel. Servicing is required when the apparatus has been damaged in any way, such as power-supply cord or plug is damaged, liquid has been spilled or objects have fallen into the apparatus, the apparatus has been exposed to rain or moisture, does not operate normally, or has been dropped.



We Want You Listening For A Lifetime

Yamaha and the Electronic Industries Association's Consumer Electronics Group want you to get the most out of your equipment by playing it at a safe level. One that lets the sound come through loud and clear without annoying blaring or distortion – and, most importantly, without affecting your sensitive hearing. Since hearing damage from loud sounds is often undetectable until it is too late, Yamaha and the Electronic Industries Association's Consumer Electronics Group recommend you to avoid prolonged exposure from excessive volume levels.



FCC INFORMATION (for US customers)

1 **IMPORTANT NOTICE: DO NOT MODIFY THIS UNIT!**

This product, when installed as indicated in the instructions contained in this manual, meets FCC requirements. Modifications not expressly approved by Yamaha may void your authority, granted by the FCC, to use the product.

2 **IMPORTANT:** When connecting this product to accessories and/or another product use only high quality shielded cables. Cable/s supplied with this product **MUST** be used. Follow all installation instructions. Failure to follow instructions could void your FCC authorization to use this product in the USA.

3 **NOTE:** This product has been tested and found to comply with the requirements listed in FCC Regulations, Part 15 for Class "B" digital devices. Compliance with these requirements provides a reasonable level of assurance that your use of this product in a residential environment will not result in harmful interference with other electronic devices.

This equipment generates/uses radio frequencies and, if not installed and used according to the instructions found in the users manual, may cause interference harmful to the operation of other electronic devices.

Compliance with FCC regulations does not guarantee that interference will not occur in all installations. If this product is found to be the source of interference, which can be determined by turning the unit "OFF" and "ON", please try to eliminate the problem by using one of the following measures:

Relocate either this product or the device that is being affected by the interference.

Utilize power outlets that are on different branch (circuit breaker or fuse) circuits or install AC line filter/s.

In the case of radio or TV interference, relocate/reorient the antenna. If the antenna lead-in is 300 ohm ribbon lead, change the lead-in to coaxial type cable.

If these corrective measures do not produce satisfactory results, please contact the local retailer authorized to distribute this type of product. If you can not locate the appropriate retailer, please contact Yamaha Electronics Corp., U.S.A. 6660 Orangethorpe Ave, Buena Park, CA 90620.

The above statements apply **ONLY** to those products distributed by Yamaha Corporation of America or its subsidiaries.

CAUTION

Use of controls or adjustments or performance of procedures other than those specified herein may result in hazardous radiation exposure.

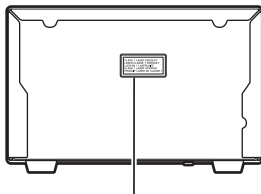

CLASS 1 LASER PRODUCT
LASER KLASSE 1 PRODUKT
LUOKAN 1 LASERLAITE
KLASS 1 LASER APPARAT
PRODUIT LASER DE CLASSE 1

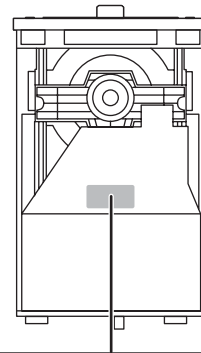

DANGER: AVOID DIRECT EXPOSURE TO THE BEAM
INVISIBLE LASER RADIATION WHEN OPEN

CAUTION: DO NOT STARE INTO BEAM
INVISIBLE LASER RADIATION WHEN OPEN

● The label is located on the bottom of the unit. (U.S.A and Canada models only)

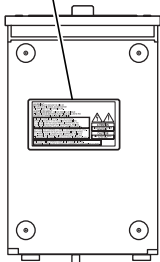

CAUTION: READ THIS BEFORE OPERATING YOUR UNIT.

- 1 To assure the finest performance, please read this manual carefully. Keep it in a safe place for future reference.
- 2 Install this unit in a well ventilated, cool, dry, clean place with at least 10 cm on the top, 10 cm on the left and right, and 10 cm at the back of this unit — away from direct sunlight, heat sources, vibration, dust, moisture, and/or cold.
- 3 Locate this unit away from other electrical appliances, motors, or transformers to avoid humming sounds.
- 4 Do not expose this unit to sudden temperature changes from cold to hot, and do not locate this unit in an environment with high humidity (i.e. a room with a humidifier) to prevent condensation inside this unit, which may cause an electrical shock, fire, damage to this unit, and/or personal injury.
- 5 Avoid installing this unit where foreign object may fall onto this unit and/or this unit may be exposed to liquid dripping or splashing. On the top of this unit, do not place:
 - Other components, as they may cause damage and/or discoloration on the surface of this unit.
 - Burning objects (i.e. candles), as they may cause fire, damage to this unit, and/or personal injury.
 - Containers with liquid in them, as they may fall and liquid may cause electrical shock to the user and/or damage to this unit.
- 6 Do not cover this unit with a newspaper, tablecloth, curtain, etc. in order not to obstruct heat radiation. If the temperature inside this unit rises, it may cause fire, damage to this unit, and/or personal injury.
- 7 Do not plug in this unit to a wall outlet until all connections are complete.
- 8 Do not operate this unit upside-down. It may overheat, possibly causing damage.
- 9 Do not use force on switches, knobs and/or cords.
- 10 When disconnecting the power cable from the wall outlet, grasp the plug; do not pull the cable.
- 11 Do not clean this unit with chemical solvents; this might damage the finish. Use a clean, dry cloth.
- 12 Only voltage specified on this unit must be used. Using this unit with a higher voltage than specified is dangerous and may cause fire, damage to this unit, and/or personal injury. Yamaha will not be held responsible for any damage resulting from use of this unit with a voltage other than specified.
- 13 To prevent damage by lightning, keep the power cord and outdoor antennas disconnected from a wall outlet or this unit during a lightning storm.
- 14 Do not attempt to modify or fix this unit. Contact qualified Yamaha service personnel when any service is needed. The cabinet should never be opened for any reasons.
- 15 When not planning to use this unit for long periods of time (i.e. vacation), disconnect the AC power plug from the wall outlet.
- 16 Be sure to read the “TROUBLESHOOTING” section on common operating errors before concluding that this unit is faulty.
- 17 Before moving this unit, press STANDBY/ON to set this unit to the standby mode, and disconnect the AC power plug from the wall outlet.
- 18 Condensation will form when the surrounding temperature changes suddenly. Disconnect the power cable from the outlet, then leave this unit alone.
- 19 When using this unit for a long time, this unit may become warm. Turn the power off, then leave this unit alone for cooling.
- 20 Install this unit near the AC outlet and where the AC power plug can be reached easily.
- 21 The batteries shall not be exposed to excessive heat such as sunshine, fire or the like.
- 22 Excessive sound pressure from earphones and headphones can cause hearing loss.

This unit is not disconnected from the AC power source as long as it is connected to the wall outlet, even if this unit itself is turned off by STANDBY/ON. This state is called the standby mode. In this state, this unit is designed to consume a very small quantity of power.

LASER SAFETY

This unit employs a laser. Due to possible eye injury, only a qualified service person should remove the cover or attempt to service this device.

DANGER

This unit emits visible laser radiation when open. Avoid direct eye exposure to beam.

When this unit is plugged into the wall outlet, do not place your eyes close to the opening of the disc tray and other openings to look into inside.

The laser component in this product is capable of emitting radiation exceeding the limit for Class 1.

WARNING

TO REDUCE THE RISK OF FIRE OR ELECTRIC SHOCK, DO NOT EXPOSE THIS UNIT TO RAIN OR MOISTURE.

FOR CANADIAN CUSTOMERS

To prevent electric shock, match wide blade of plug to wide slot and fully insert.

This Class B digital apparatus complies with Canadian ICES-003.

CAUTION

Danger of explosion if battery is incorrectly replaced. Replace only with the same or equivalent type.

CONTENTS

INTRODUCTION

FEATURES	2
SUPPLIED ACCESSORIES	2
CONTROLS AND FUNCTIONS	3
Front panel	3
Front panel display	4
Remote control	5

PREPARATION

CONNECTING SPEAKERS	9
Connecting a subwoofer	10
CONNECTING ANTENNAS	11
Connecting the FM antenna	11
CONNECTING THE POWER CABLES	11
CONNECTING HEADPHONES	11
CONNECTING EXTERNAL COMPONENTS	12
Connecting a USB device	12
Connecting an iPod™	12

BASIC OPERATIONS

BASIC RECEIVER OPERATIONS	13
SETTING THE SLEEP TIMER	14
BASIC PLAYBACK OPERATIONS FOR DISCS AND USB DEVICES	15
Switching the playback information display	16
Repeating playback (Repeat Play)	17
Playing back randomly (Shuffle Play)	17

TUNER OPERATIONS

FM TUNING	18
Automatic tuning	18
Manual tuning	18
Automatic preset tuning	18
Manual preset tuning	19
Selecting preset stations	19

OTHER OPERATIONS

CONTROLLING iPod™	20
Using iPod™	20

ADDITIONAL INFORMATION

TROUBLESHOOTING	22
General	22
Radio reception	22
iPod™	23
USB	23
Disc Playback	24
Remote control	24
NOTES ABOUT DISCS/MP3, WMA FILES	25
GLOSSARY	27
Audio information	27
Copyright and logo marks	27
SPECIFICATIONS	27

INTRODUCTION

PREPARATION

BASIC
OPERATIONS

TUNER
OPERATIONS

OTHER
OPERATIONS

ADDITIONAL
INFORMATION

English

FEATURES

- Maximum RMS output power per channel
20W + 20W (10% THD, 1 kHz, 6Ω)
- 30-station FM preset tuning
- iPod playability
- Plays Audio CDs, MP3/WMA discs
- CD Text data display
- MP3/WMA file playability stored on USB device
- Multi function remote control

■ About this manual

- This manual describes how to operate this unit using a remote control except when it is not available. Some of these operations are also available using the front panel buttons.
- The round shaped button on the center of the remote control is called Center in this manual.
- ✨ indicates a tip for your operation.
- Notes contain important information about safety and operating instructions.
- This manual is printed prior to production. Design and specifications are subject to change in part as a result of improvements, etc. In case of differences between the manual and the product, the product has priority.

SUPPLIED ACCESSORIES

This product includes the following accessories. Before connecting speakers, make sure you received all of the following parts.

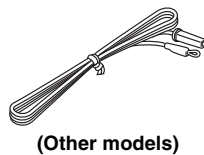
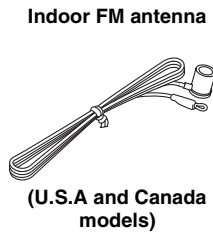
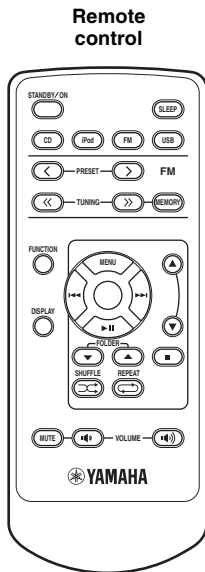

USB cap*



Dock cover*

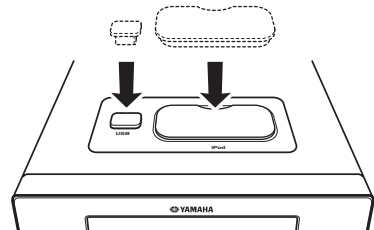

When the USB cap and the Dock cover are covered.

*The USB cap and the Dock cover are supplied with this unit to cover the USB port and the iPod terminal when not using.

CONTROLS AND FUNCTIONS

Front panel

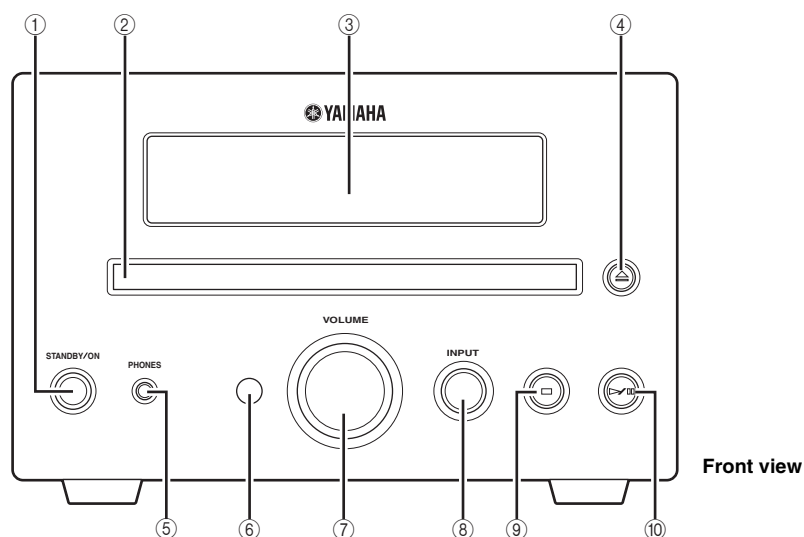
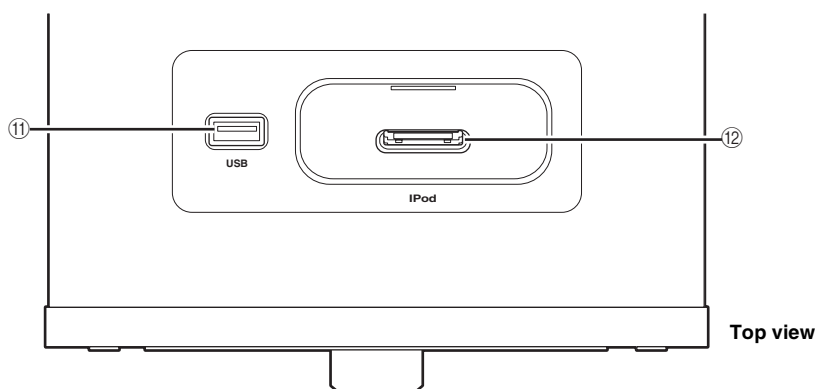

① **STANDBY/ON**

Turns this unit on or sets it to the standby mode.

② **Disc Tray**

Loads a disc to be played back.

③ **Front panel display**

Shows the various information such as the tuning frequency.

④ 

Opens and closes the disc tray.

⑤ **PHONES**

Outputs audio signals for private listening with headphones.

⑥ **Remote control sensor**

Receives signals from the remote control.

⑦ **VOLUME**

Adjusts the volume level.

⑧ **INPUT**

Selects an input source.

⑨ 

Stops playback (see page 15).

⑩ 

Starts or pauses playback (see page 15).

⑪ **USB port**

Connect your USB device (see page 12).

⑫ **iPod terminal**

Connect your iPod (see page 12).

Front panel display

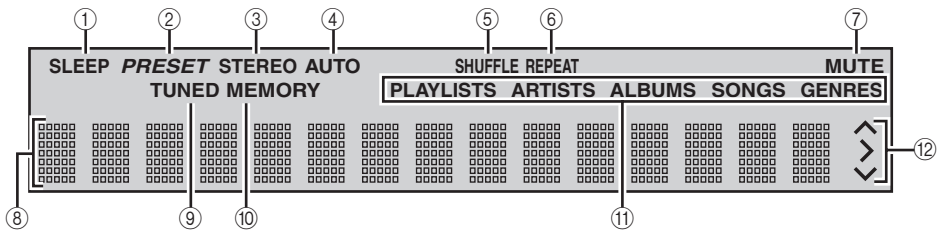

① **SLEEP indicator**

Lights up when the sleep timer is on (see page 14).

② **PRESET indicator**

Lights up when you preset radio stations (see page 19).

③ **STEREO indicator**

Lights up when this unit is receiving a strong signal from an FM stereo broadcast.

④ **AUTO indicator**

Lights up when this unit is in the Automatic Tuning mode (see page 18).

⑤ **SHUFFLE indicator**

Lights up when you set your iPod/CD/USB in shuffle mode.

⑥ **REPEAT indicator**

Lights up when you set your iPod/CD/USB in repeat mode.

⑦ **MUTE indicator**

Lights up when the sound is muted.

⑧ **Multi information display**

Shows the various information such as the tuning frequency.

⑨ **TUNED indicator**

Lights up when this unit is tuned into a station.

⑩ **MEMORY indicator**

Lights up when you preset radio stations automatically or manually.

⑪ **Multi information indicator**

Light up the menu currently selected (see page 20).

⑫ **Operation indicators**

Show operable cursor keys when operating with the FUNCTION or iPod menu with the menu browse mode (see page 20).

Remote control

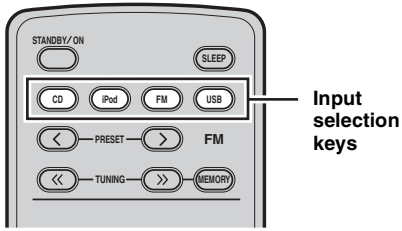

Common functions

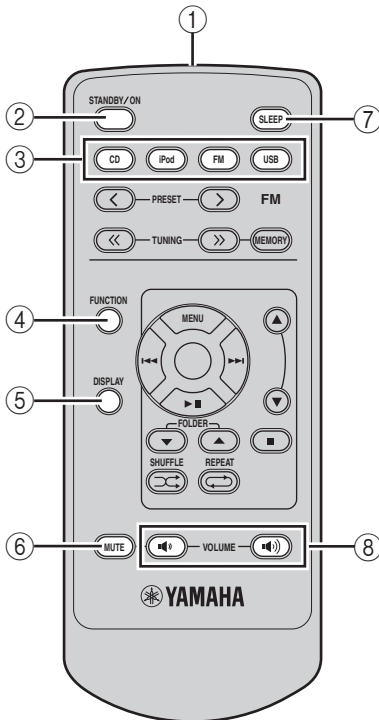

This remote control can operate the system components and an iPod stationed in a terminal on the top panel of this unit.

To operate the CD, USB device, tuner functions, or an iPod using the remote control, you need to set this unit to the corresponding input mode.

To switch the input mode of this unit

Press the corresponding input selection key on the remote control (or INPUT on the front panel). The input mode automatically changes to iPod when you connect the iPod during the playback (see page 12).

The name of the corresponding input source appears in the front panel display of this unit.

Operations common to all modes

The following operations are available for this unit when it is set to any input mode.

① Infrared signal transmitter

Sends signals to the component you want to control.

② STANDBY/ON

Turns this unit on or sets it to the standby mode.

③ Input selection keys

Select the input source.

④ FUNCTION

By pressing FUNCTION, you can select DIMMER, TREBLE, BASS, BALANCE, or ECO MODE.

⑤ DISPLAY

Switches the information shown in the front panel display (see page 16).

⑥ MUTE

Turn off the sound. To restore the sound, press MUTE again or press VOLUME (down)/ (up).

⑦ SLEEP

Sets the sleep timer (see page 14).

⑧ VOLUME (down) / (up)

Adjusts the overall volume level.

■ **CD/USB mode**

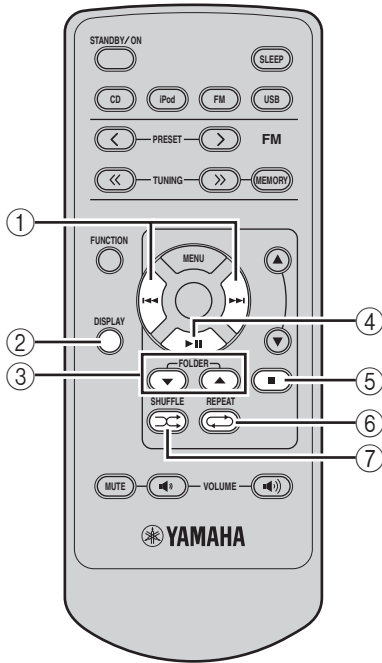

Operations available in CD/USB mode

The following operations are available for this unit when the CD or USB mode is selected.

① **SKIP** ◀▶

Skips to the beginning of the current track or next track. Press and hold to fast reverse or fast forward (see page 15). Press ◀▶ twice to skip to the beginning of the previous track.

② **DISPLAY**

Switches the disc/USB information shown in the front panel display (see page 16).

③ **FOLDER** ▼ / ▲

Press FOLDER ▼ / ▲ to playback a first file of selected folder for an MP3 or a WMA folder recorded on disc/USB device (see page 15).

*During Shuffle Play, these buttons cannot be used.

④ **PLAY/PAUSE** ▶||

Starts or pauses playback (see page 15).

⑤ **STOP** ■

Stops playback (see page 15).

⑥ **REPEAT** ↺

Selects the Repeat Play mode (see page 17).

⑦ **SHUFFLE** ↻

Select the Shuffle Play feature (see page 17).

■ **FM mode**

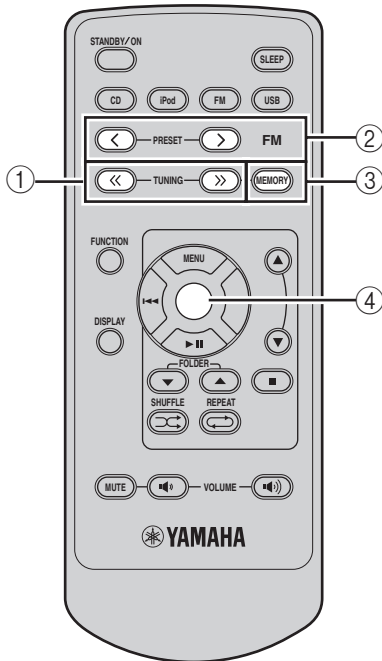

Operations available in FM mode

The following operations are available for this unit when the FM mode is selected.

① **TUNING** ◀ / ▶

Press TUNING ◀ / ▶ to Manual tuning and press and hold TUNING ◀ / ▶ to Automatic tuning.

② **PRESET** ◀ / ▶

Press PRESET ◀ / ▶ to select a preset station (see page 18).

③ **MEMORY**

Starts preset memory mode.

④ **Center**

Press Center to fix the current setting.

■ iPod mode

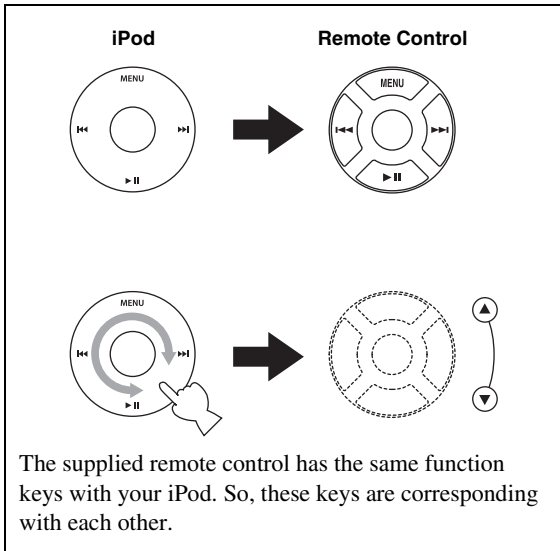
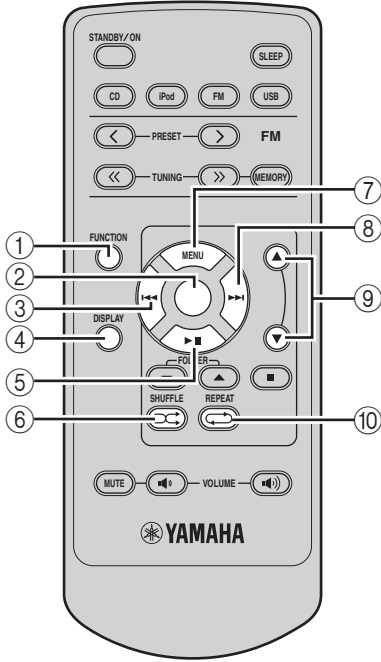

Operations available in iPod mode

The following operations are available for the iPod stationed in the terminal. For details on iPod operations, see “Using iPod™” on page 20.

① **FUNCTION**

Switches between the simple remote mode and menu browse mode.

② **Center**

Press Center to enter the selected group. (Pressing Center starts playback when a song is selected.)

③ **⏮**

Skips to the beginning of the current track. Press and hold to fast reverse. Press twice to skip to the previous track.

④ **DISPLAY**

Displays the song information while iPod is in menu browse mode (see page 16).

⑤ **⏸**

Starts or pauses playback.

⑥ **SHUFFLE**

Selects the shuffle playback mode (see page 21).

⑦ **MENU**

Returns to the upper level in the iPod menu.

⑧ **⏭**

Skips to the next track. Press and hold to fast forward.

⑨ **▲ / ▼**

Press ▲ or ▼ to select an item in the selected group.

⑩ **REPEAT**

Selects the repeat playback mode (see page 21).

■ **Preparing the remote control**

The remote control comes with the battery already installed. Before using the remote control for the very first time, pull out the insulation sheet, as shown.

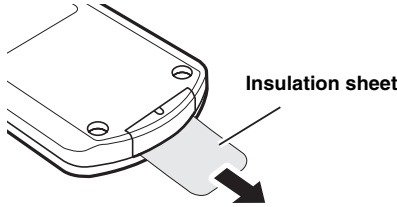

 Remove the transparent sheet before using the remote control.

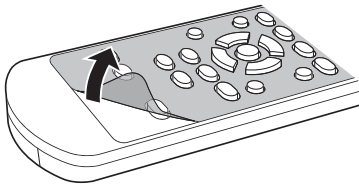

■ **Using the remote control**

Use the remote control within 6 m (20 feet) of the component you want to control and point it toward its remote control sensor (see page 3).

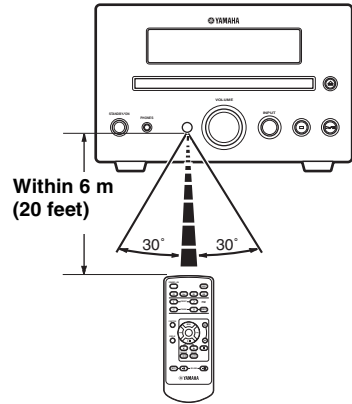

Notes

- Be careful not to spill liquid on the remote control.
- Be careful not to drop the remote control.
- Do not leave the remote control in the following places:
 - hot or humid places, such as near a heater or in a bathroom
 - extremely cold places
 - dusty places

■ **Replacing the battery in the remote control**

Change the battery when the operation range of the remote control decreases.

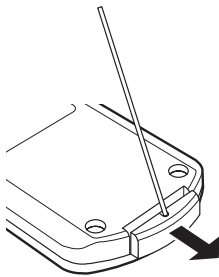

Use a straight pin to remove the cover.

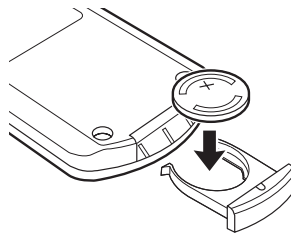

Replace the battery with a new CR2025 battery.

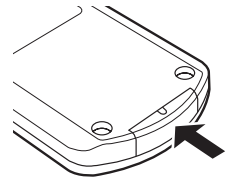

Close the cover.

Notes

- Insert the battery according to the polarity markings (+ and -).
- If the battery runs out, immediately remove it from the remote control to prevent an explosion or acid leak.
- If the battery starts leaking, dispose of it immediately. Be careful not to let the leaking battery acid touch your skin or clothing.
- Before inserting a new battery, wipe the compartment clean.
- Dispose of batteries according to your regional regulations.

CONNECTING SPEAKERS

Follow the procedure below to connect speakers to this unit. For information on your speakers, refer to the owner's manual supplied for the speakers.

CAUTION

Do not connect the power cable of this unit until all cable connections are completed.

Notes

- Be sure to connect the left channel (L), right channel (R), “+”(red) “-”(black) properly. If the connections are faulty, no sound will be heard from the speakers, and if the polarity of the speaker connections is incorrect, the sound will be unnatural and lacks bass.
- Do not let the bare speaker wires touch each other or do not let them touch any metal part of this unit. This could damage this unit and/or the speakers.
- Use speakers with the specified impedance shown on the rear panel of this unit.

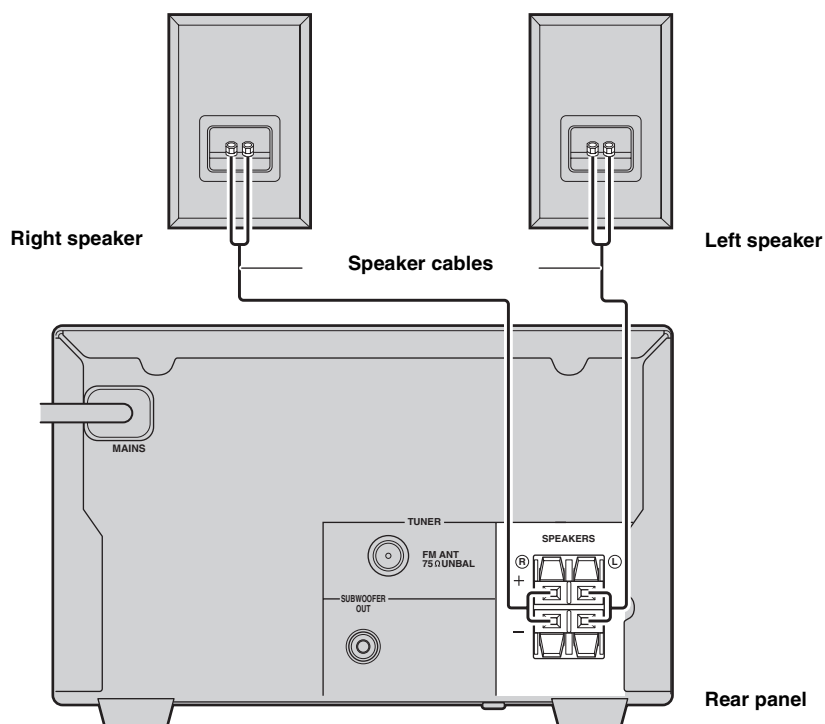

- 1 Remove approximately 10 mm (3/8 in) of insulation from the end of each speaker cable and then twist the exposed wires of the cable together to prevent short circuits.

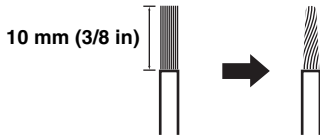

- 2 Press and hold the lever.

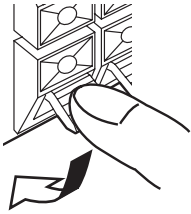

Red: positive (+)
Black: negative (-)

- 3 Insert one bare wire. By releasing the lever, the lever is replaced.

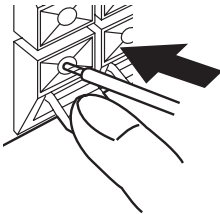

Red: positive (+)
Black: negative (-)

■ Notes on the speaker cord

A speaker cord is actually a pair of insulated cables running side by side. One cable is colored or shaped differently, perhaps with a stripe, groove or ridge. Connect the striped (grooved, etc.) cable to the “+”(red) terminals on this unit and your speaker. Connect the plain cable to the “-”(black) terminals on this unit and your speaker.

Connecting a subwoofer

The low frequency range of the left channel and the right channel are mixed to output at the SUBWOOFER OUT jack.

Connect the SUBWOOFER OUT jack on this unit to the INPUT jack on the subwoofer using the subwoofer cable (commercially available).

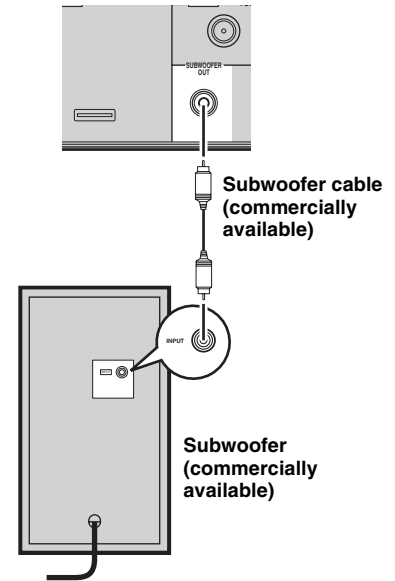

Note

Do not connect the power cable of this unit and the subwoofer until all cable connections are completed.

CONNECTING ANTENNAS

To enjoy radio on this unit, connect the supplied FM antenna to the designated terminals. If there is a problem of weak radio wave reception in your area or you want to improve radio reception, we recommend that you use commercially available outdoor antennas. For details, consult the nearest authorized Yamaha dealer or service center.

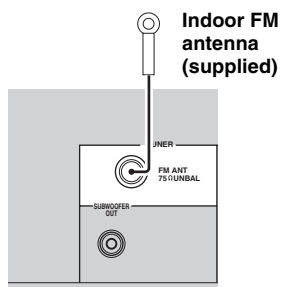

Connecting the FM antenna

- 1 Connect the supplied indoor FM antenna to the FM jack of this unit.
- 2 Place the antenna away from this unit and speaker cables.

PREPARATION

CONNECTING THE POWER CABLES

After you made all connections, connect the power cables of this unit and subwoofer (optional).

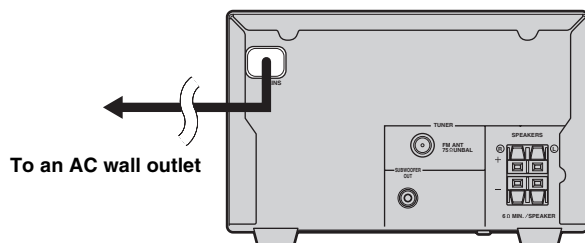

CONNECTING HEADPHONES

You can connect your headphones to the PHONES jack on the front panel of this unit. The sound from the speakers stops.

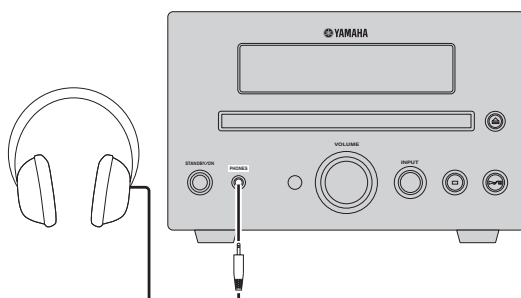

English

CONNECTING EXTERNAL COMPONENTS

You can connect a USB device or an iPod to this unit. For information on your component, refer to the owner's manual supplied with the component.

Connecting a USB device

This unit has a USB port and can access MP3 or WMA files saved on your USB device. Connect your USB device to the USB port on the top panel of this unit. For playback information of a USB device, see page 15.

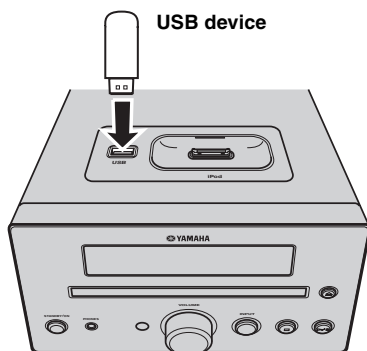

■ Supported USB devices

This unit supports USB mass storage class devices (e.g., flash memories) using FAT16 or FAT32 format.

Notes

- Some devices may not work properly even if they meet the requirements.
- If your USB device is not played back after you connected it to this unit, follow any of the procedures below.
 - Set this unit to the standby mode, and turn it on again.
 - Disconnect the device while this unit is in the standby mode.
 - Then connect the device again and turn on this unit.
 - Connect an AC adapter if supplied with the device.
- If the USB device is not played back even after you performed the procedure(s) above, the device may not be playable on this unit.
- Do not connect devices other than USB mass storages class devices.
- Yamaha and suppliers accept no liability for the loss of data saved on the USB devices connected to this unit. As a precaution, it is recommended that the files are made backup copies.
- Playability of and power supply to all kind of USB devices are not guaranteed.
- Your USB device is automatically charged when your USB device is connected to the USB port even when this unit is in standby mode and ECO MODE is OFF.
- To remove USB device safely, disconnect after the playback is stopped.

Connecting an iPod™

This unit equips the iPod terminal on the top panel where you can directly station your iPod and control playback of your iPod using the supplied remote control.

Use this unit with the iPod dock adapter (supplied with your iPod or commercially available) appropriate for your iPod. If you use this unit without using an appropriate iPod dock adapter, loose connection may result.

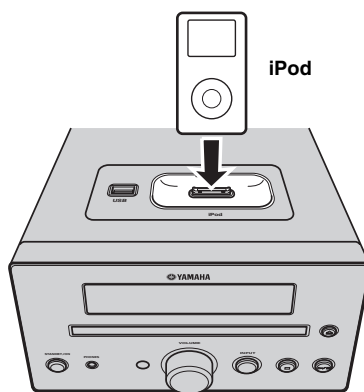

Notes

- Only iPod (Click and Wheel), iPod nano, iPod mini, and iPod touch are supported.
- Do not connect any iPod accessories (such as headphones, a wired remote control, or an FM transmitter) to our iPod when it is stationed in the terminal.
- Unless your iPod is firmly stationed in the terminal, audio signals may not be output properly.
- Once the connection between your iPod and this unit is complete, "iPod" appears in the front panel display. If the connection between your iPod and this unit fails, a status message appears in the front panel display. For a complete list of connection status message, see the iPod section in "TROUBLESHOOTING" on page 23.
- Your iPod is automatically charged when your iPod is stationed in the terminal even when this unit is in standby mode and ECO MODE is OFF.
- To remove iPod safely, disconnect after the playback is stopped.

BASIC RECEIVER OPERATIONS

Follow the procedure below to select an input source and adjust the sound settings on this unit.

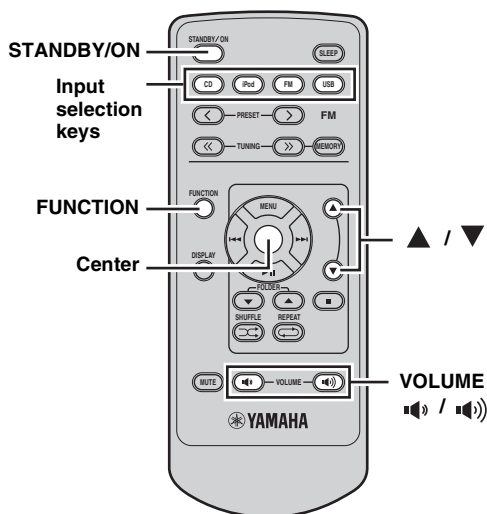
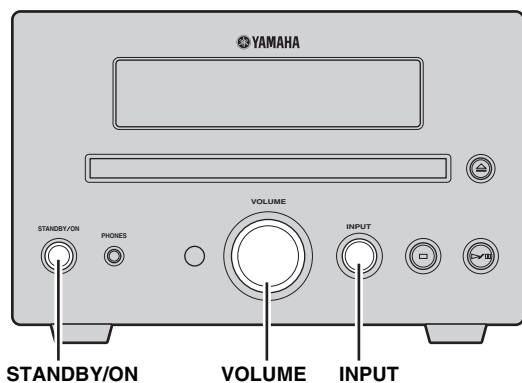

- 1 Press STANDBY/ON to turn on this unit.**
The front panel display lights up.
- 2 Press one of the input selection keys or press INPUT on the front panel to select the desired input source. Each time you press INPUT, the input source changes in order of CD, iPod, FM and USB.**
- 3 Start playback on the selected source component or select a radio station.**
For information on the disc playback, see page 15, and for information on tuning, see page 18.

- 4 Press (down) / (up) to adjust the volume to the desired output level.**

■ To adjust the audio quality

- 1 Press FUNCTION to display the function menu.**
- 2 Press / repeatedly to select TREBLE, BASS, or BALANCE and press Center.**
- 3 Press / repeatedly to adjust the setting and press Center.**

TREBLE: Adjusts the high frequency response.

BASS: Adjusts the low frequency response.

BALANCE: Adjusts the volume level of each left and right speaker channel.



TREBLE, BASS, and BALANCE are not adjustable when using the headphones.

■ To dim the display

You can dim the front panel display of this unit.

- 1 Press FUNCTION to display the function menu.**
 - 2 Press / repeatedly to select DIMMER and press Center.**
Press / to select the brightness and press Center.
- ## ■ To use the ECO mode
- This mode reduces power consumption during the standby mode. Your iPod or USB device cannot be charged during standby mode and ECO MODE is ON.
- 1 Press FUNCTION to display the function menu.**
 - 2 Press / repeatedly to select ECO MODE and press Center.**
 - 3 Press / to select ON or OFF and press Center.**

SETTING THE SLEEP TIMER

The sleep timer sets this unit to the standby mode after the specified time elapses.

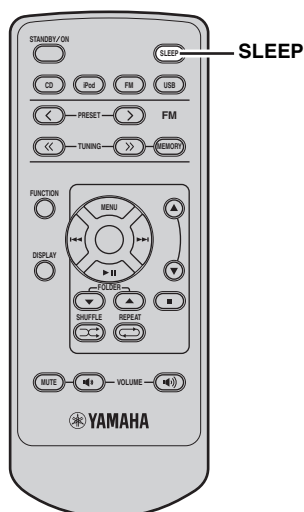

Press SLEEP repeatedly to select the desired duration.

Each time you press the key, the duration changes as follows.

The SLEEP indicator lights up in the front panel display.

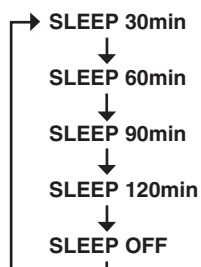

- The sleep timer is canceled if you set this unit to the standby mode.
- If you press SLEEP while the sleep timer is set, the remaining time appears in the front panel display.

To cancel the sleep timer

Press SLEEP repeatedly to select “SLEEP OFF”.

BASIC PLAYBACK OPERATIONS FOR DISCS AND USB DEVICES

You can enjoy playback your audio CDs, USB devices, and MP3 or WMA files recorded on a disc/USB device. Some operations may be different or restricted depending on the disc/USB device. Before playing back, check the compatibility of your disc/USB device with this unit (see page 25).

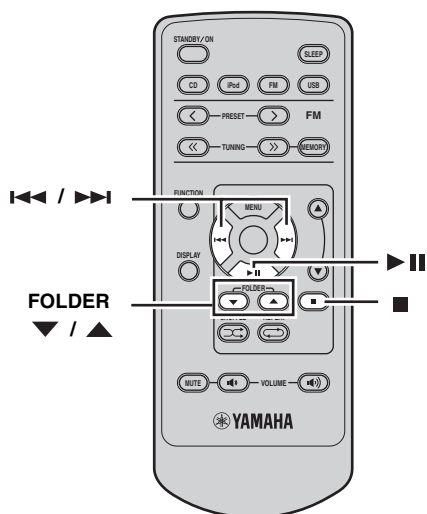

- Some files may not work properly depending on the USB device specification.
- Copyright-protected files cannot be played back.
- This unit can play back files of 4 GB in size or less.
- When the input source is USB and this unit is turned on with the USB device connected, playback starts automatically.

To stop playback

Press ■ .

To pause playback

Press ►||.

To return to normal playback, press ►||.

To fast reverse or fast forward

To fast reverse, hold down ◀◀◀.

To fast forward, hold down ▶▶▶.

To skip tracks

To skip to the start of the current track, press ◀◀◀.

To skip to the next track, press ▶▶▶.

To skip to the previous track, quickly press ◀◀◀ twice.

To skip a folder for an MP3 or WMA file

To skip a folder, press FOLDER ▼ / ▲ .

■ About MP3 and WMA discs/USB device

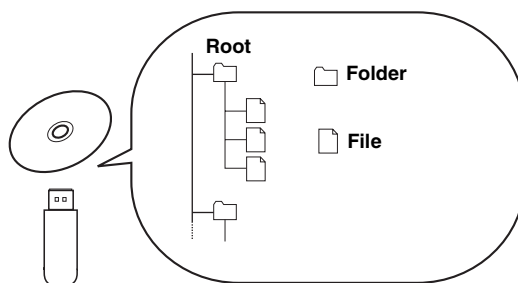

You can play back MP3 or WMA files recorded on your CD-R, CD-RW or USB device. This unit regards files in the disc/USB device as tracks (as shown above).

To start disc playback

1 Select CD as the input source (see page 13).

2 Press ►|| while a disc is loaded.

For an audio CD, playback starts from the first track, and for MP3 or WMA files, playback starts in alphanumeric order by the filename.



- You can open and close the disc tray by pressing ◀ on the front panel of this unit.
- You can also start disc playback by pressing ▶ on the front panel.
- When the input source is CD and this unit is turned on with a disc loaded, disc playback starts automatically.

To start USB device playback

1 Select USB as the input source (see page 13).

2 Connect your USB device to the USB port on this unit.

The reading time may exceed 30 seconds depending on the number of files/folders.

For a USB device, playback starts automatically in order by the date and time of creation if playable files are in the USB device.

Notes

- Total time does not appear on the front panel for USB device playback.
- If the USB device is partitioned, only the first partition is displayed.

Switching the playback information display

You can switch the disc playback information shown in the front panel display of this unit. Available information differs depending on the type of the disc/USB device.

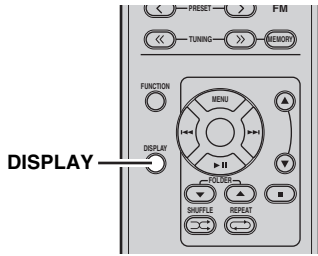

Press **DISPLAY** repeatedly while playing back a disc/USB device.

Each time you press the key, the information display changes as described in “Playback information for audio CDs” and “Playback information for MP3 or WMA files recorded on discs/USB devices” on page 16.

Note

Some special characters may not be shown properly.

■ Playback information for audio CDs

The following information is available during playback of an audio CD. “Track Title”, “Artist”, and “Album Title” are available only for a CD TEXT disc.

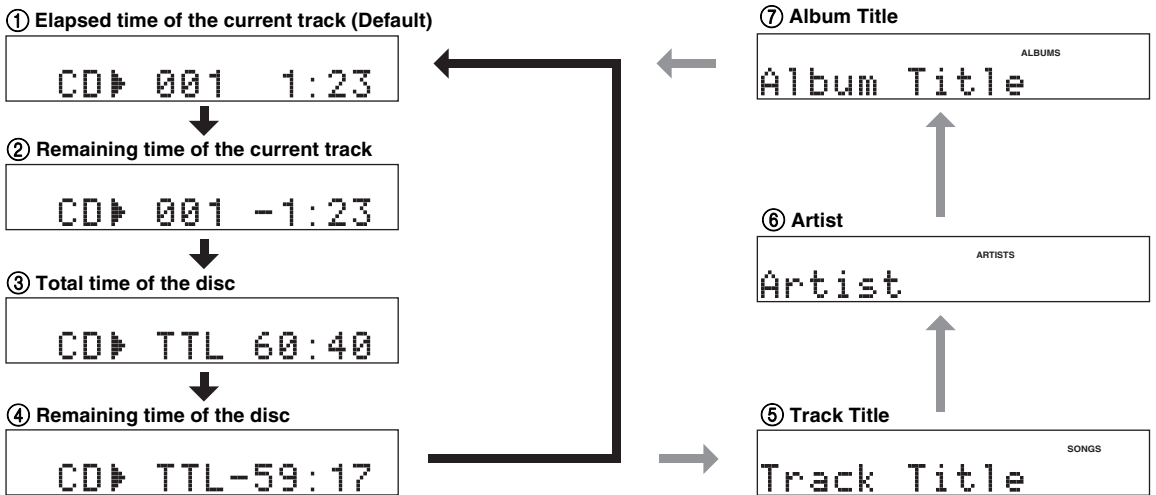

Note

You can switch the playback information ① ② ⑤ ⑥ ⑦ above during playback of your iPod in the menu browse mode (see page 21).

■ Playback information for MP3 or WMA files recorded on discs/USB devices

The following information is available during playback of an MP3 or WMA files recorded on discs/USB device.



Repeating playback (Repeat Play)

You can repeat the playback of the selected item in your disc/USB device.

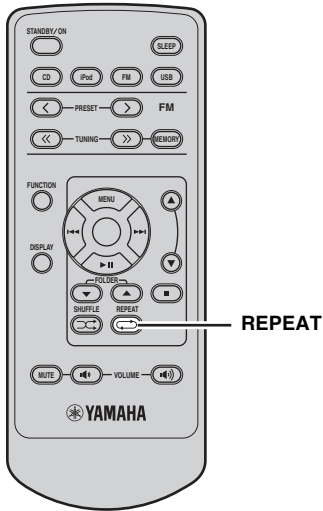

1 Play back the disc or track you want to repeat.

2 Press REPEAT to select the desired Repeat Play mode.

Each time you press the key, the Repeat Play mode in the front panel display changes as follows.

Audio CD

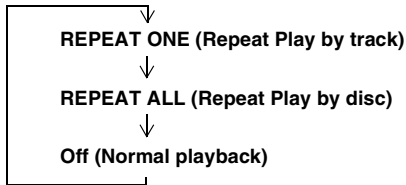

MP3/WMA disc/USB device

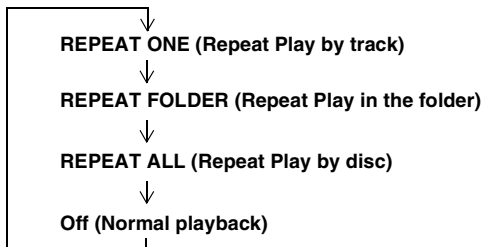

To cancel Repeat Play

Press REPEAT repeatedly so that the Repeat Play mode indicator disappears from the front panel display or press ■ .

Playing back randomly (Shuffle Play)

You can play back tracks in your disc/USB device in random order.

Note

When playing back with Shuffle Play, the remaining time of the disc cannot be displayed.

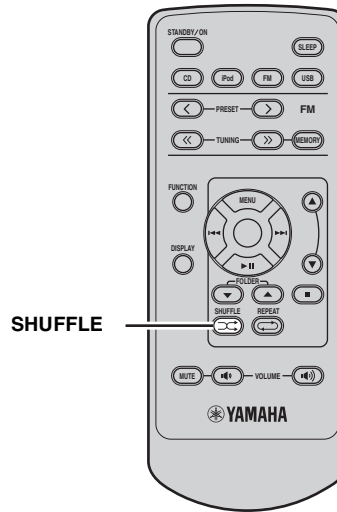

Press SHUFFLE.

Each time you press the key, the Shuffle play mode in the front panel display changes as follows.

Audio CD

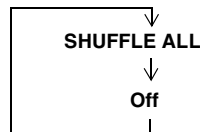

MP3/WMA disc/USB device

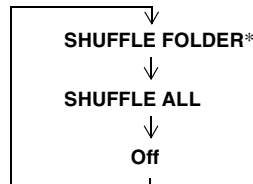

* The SHUFFLE FOLDER means tracks in the folder is play back in randomly.

To cancel Shuffle Play

Press SHUFFLE repeatedly so that the SHUFFLE indicator disappears from the front panel display or press ■ .

FM TUNING

There are 2 tuning methods: automatic and manual. Automatic tuning is effective when station signals are strong and there is no interference. If the signal from the station you want to select is weak, tune into it manually. You can also use the automatic and manual preset tuning features to store up to 30 stations.

Automatic tuning

Automatic tuning is effective when station signals are strong and there is no interference.

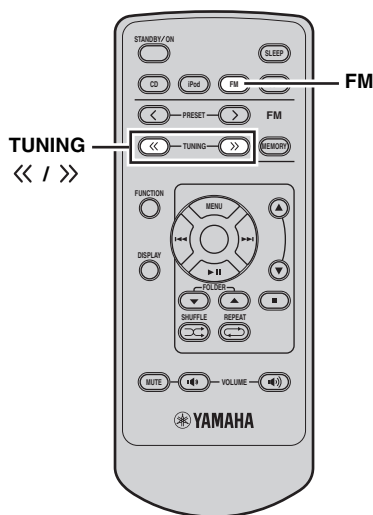

1 Press FM to set this unit to the FM mode.

2 Press and hold TUNING << / >> to begin automatic tuning.

The AUTO indicator lights up on the front panel display. This unit automatically detects radio stations that have strong signals for your selection, and automatically ends automatic tuning. The AUTO indicator disappears from the front panel display.

Manual tuning

If the signal received from the station you want to select is weak, tune into it manually.

1 Press FM to set this unit to the FM mode.

2 Press TUNING << / >> repeatedly to tune into the desired station manually.



Manually tuning into an FM station automatically switches the tuner to monaural reception to increase the signal quality.

Automatic preset tuning

Follow the procedure below to preset radio stations automatically.

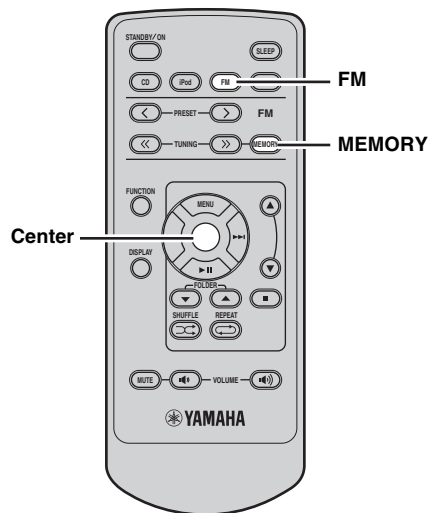

1 Press FM to set the unit to the FM mode.

2 Press and hold MEMORY for more than 2 seconds.

The “AUTO PRESET” and “Push Center Key” appear in the front panel display alternately. To cancel, press MEMORY.

3 Press Center to start searching automatically.

- Auto Preset starts at the lowest frequency toward the highest frequency.
- This unit automatically applies a preset number to each detected station.

4 Search will stop after finding appropriate station and stores as a preset station.

5 Search will start again to find a next station.

Notes

- You can preset up to 30 of FM stations with Auto Preset.
- Any stored station data existing under a preset station number is cleared when you store a new station under the same preset station number.

Manual preset tuning

You can also store up to 30 stations manually.

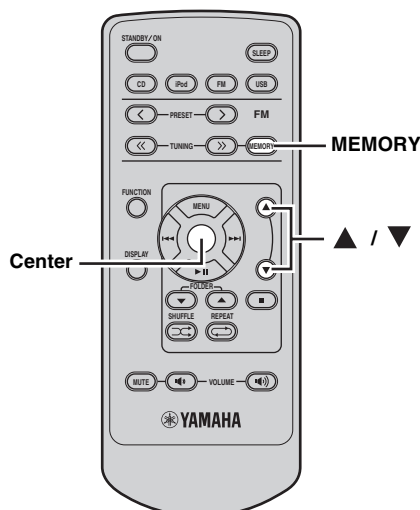

1 Tune into a radio station you want to preset.
See page 18 for tuning instructions.

2 Press MEMORY.

The MEMORY and PRESET indicators light up in the front panel display until you cancel manual preset.

To cancel, press MEMORY.

3 Press ▲ / ▼ repeatedly to select a preset station number.

4 Press Center while the preset station number you selected is flashing.

The MEMORY indicator disappears from the front panel display.

5 Repeat steps 1 to 4 until all desired stations are preset.

Selecting preset stations

You can tune into any desired station simply by selecting the preset station under which it was stored (see page 18).

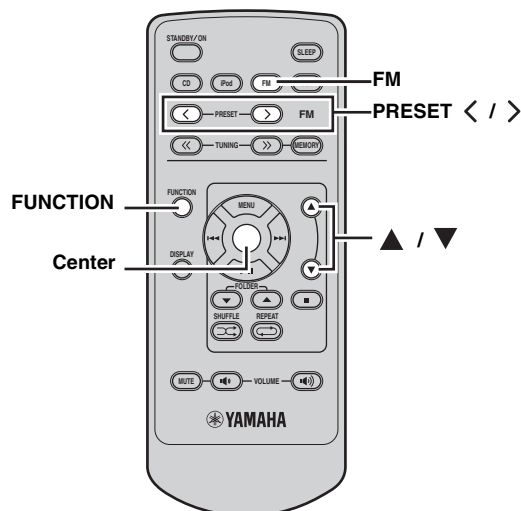

1 Press FM to set the unit to the FM mode.

2 Press PRESET < / > to select a preset station.

■ **To delete the preset station**

1 Press FM to set the unit to the FM mode.

2 Press FUNCTION to display the function menu. Press ▲ / ▼ to select PRESET DELETE and press Center.

3 Press ▲ / ▼ to select the preset number you want to delete and press Center.

CONTROLLING iPod™

In addition to controlling this unit, you can operate your iPod stationed in a terminal using the supplied remote control.

Using iPod™

Once you have stationed your iPod in a terminal on the top panel of this unit (see page 12), you can enjoy playback of your iPod using the supplied remote control. The operations of your iPod are available with the aid of front panel display (menu browse mode) or without it (simple remote mode).

Notes

- Only iPod (Click and Wheel), iPod nano, iPod mini, and iPod touch are supported.
- Some features may not be compatible depending on the model or the software version of your iPod.



- For a complete list of the remote control functions used to control your iPod, refer to “iPod mode” (see page 7).
- For a complete list of status messages that appear in the front panel display, refer to the “iPod™” section in “TROUBLESHOOTING” (see page 23).

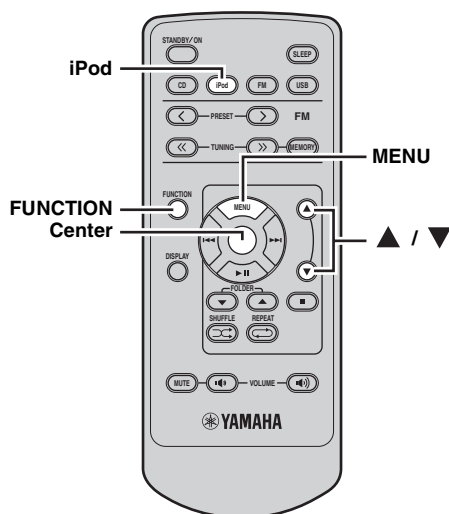

■ Simple remote mode

In the simple remote mode, you can operate the iPod menu by viewing the iPod using the iPod controls or the supplied remote control.

1 Press iPod to set this unit to the iPod mode.

2 Press FUNCTION and ▲ / ▼ to show iPod MODE on the front panel display and press Center.

3 Press ▲ / ▼ to select SIMPLE REMOTE. Press Center while SIMPLE REMOTE is blinking on the front panel display.

- You can also select the menu browse mode by pressing ▲ / ▼ so, MENU BROWSE appears on the front panel display. For details, refer to page 24.

4 Use MENU/ ▲ / ▼ / Center to operate the iPod menu, and then press Center to start playback of the selected song (or group).

■ Menu browse mode

In the menu browse mode, you can operate the iPod menu using the front panel display.

Note

There are some characters that cannot be displayed in the front panel display of this unit. Those characters are replaced with underscore “_”.

iPod menu



1 Select the menu browse mode.

To choose the menu browse mode, please refer to step 3 of "Simple remote mode" in page 20.

The top of the iPod menu appears in the front panel display.



Operation indicators



The operation indicators (see page 4) show the operable cursor keys in each step.

2 Press ▲ / ▼ to select the menu, and then press Center to enter the selected menu.

The name of the first item stored in the selected menu appears.



- The Multi information indicators (see page 4) show the iPod menu currently selected.
- To return to the upper level in the iPod menu, press MENU.

3 Repeat step 2 until you select the desired item, and then press Center to start playback of the desired item (group or song).



While playing back a track (or group) with the menu browse mode, you can switch the playback information (such as song name, elapsed time, artist name, or album name) displayed in the front panel display by pressing DISPLAY.

■ Repeating playback (Repeat Play)

You can repeat playback of the selected items in your iPod.

Press REPEAT to select the desired Repeat Play mode.

Each time you press the key, the Repeat Play mode changes as follows. To use properly, please check it with your iPod.

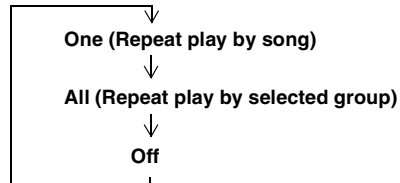

■ Playing back randomly (Shuffle Play)

You can play back tracks in your iPod in random order.

Press SHUFFLE.

Each time you press the key, the Shuffle Play mode changes as follows. To use properly, please check it with your iPod.

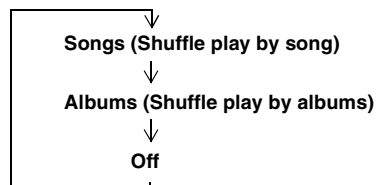

TROUBLESHOOTING

Refer to the table below when this unit does not function properly. If the problem you are experiencing is not listed below or if the instruction below does not help, turn off this unit, disconnect the power cable, and contact the nearest authorized Yamaha dealer or service center.

General

Problem	Cause	Remedy	See page
This unit fails to turn on or enters the standby mode soon after the power is turned on.	The power cable is not connected or the plug is not completely inserted.	Connect the power cable firmly.	11
	This unit has been exposed to a strong external electric shock (such as lightning or strong static electricity).	Set this unit to the standby mode, disconnect the power cable, plug it back in after 30 seconds and then use it normally.	—
No sound	No appropriate input source has been selected.	Select an appropriate input source with the INPUT on the front panel (or the input selection keys on the remote control).	—
	Speaker connections are not secure.	Secure the connections.	9
	The volume is turned down.	Turn up the volume.	—
	Signals this unit cannot reproduce are being input from a source component, such as a CD-ROM.	Play a source whose signals can be reproduced by this unit.	—
Sound is heard from the speaker on one side only.	Incorrect cable connections.	Connect the cables properly. If the problem persists, the cables may be defective.	9
There is noise interference from digital or radio frequency equipment.	This unit is too close to the digital or high-frequency equipment.	Move this unit further away from such equipment.	—

Radio reception

Problem	Cause	Remedy	See page	
FM	FM stereo reception is noisy.	The characteristics of FM stereo broadcasts may cause this problem when the transmitter is too far away or the antenna input is poor.	Check the antenna connections.	11
			Try using a high-quality directional FM antenna.	—
			Use the manual tuning method.	18
	There is distortion, and clear reception cannot be obtained even with a good FM antenna.	There is multi-path interference.	Adjust the antenna position to eliminate multi-path interference.	—
	The desired station cannot be tuned into with the automatic tuning method.	The signal is too weak.	Use a high-quality directional FM antenna.	—
			Use the manual tuning method.	18

iPod™**Note**

In case of a transmission error without a status message appearing in the front panel of this unit, check the connection to your iPod (see page 12).

Status message	Cause	Remedy	See page
iPod Connecting	This unit is in the middle of recognizing the connection with your iPod. This unit is in the middle of acquiring song lists from your iPod.		
Connect error	There is a problem with the signal path from your iPod to this unit.	Turn off this unit and reconnect the iPod. Try resetting your iPod.	12 —
Unknown iPod	The iPod being used is not supported by this unit.	Only iPod (Click and Wheel), iPod nano, iPod mini, and iPod Touch are supported.	—
iPod	Your iPod is properly stationed in an iPod terminal.		
iPod Unplugged	Your iPod was removed from an iPod terminal.	Station your iPod back in an iPod terminal.	12

USB**Note**

In case of a transmission error without a status message appearing in the front panel of this unit, check the connection to the USB device (see page 12).

Status message	Cause	Remedy	See page
Not Connected	The USB device is not connected firmly.	Connect the USB device again.	12
Not Supported	Connected the USB device not playable on this unit.	Connect playable USB device.	12
Over Current	Connected the USB device not playable on this unit. Connected the USB device diagonally.	Disconnect the USB device. Change input source other than USB and select USB as input source again. Then connect playable USB device again.	12

Disc Playback

Problem	Cause	Remedy	See page
Power turns on but immediately shuts off.	The power cable is not connected or the plug is not completely inserted.	Connect the power cable firmly.	11
No sound or distorted sound	The sampling rate of a MP3 or WMA file may not be compatible with this unit.	Check the sampling rate and bit rate of an MP3 or WMA file are compatible with this unit.	25
Disc playback does not start.	You may use a CD-R/RW that is not finalized.	Finalize the CD-R/RW.	—
	The disc label may not be facing up.	Check that the disc label is facing up.	—
	The disc may be defective.	Try to play back another disc. If the same problem does not happen, the disc you want to play back is defective.	—
	MP3/WMA disc may not contain sufficient music tracks to be played back.	Check that your MP3/WMA disc contains at least 5 MP3/WMA music files. If the number of files is small, the disc may not be recognized.	—
	The sampling rate of a MP3 or WMA file may not be compatible with this unit.	Check the sampling rate and bit rate of an MP3 or WMA file are compatible with this unit.	25
USB playback does not start.	Improper USB device connections.	Connect the USB device again.	12
	The MP3 or WMA formats are not compatible with this unit.	Replace the file with a correctly recorded file playable with this unit.	25

Remote control

Problem	Cause	Remedy	See page
The remote control does not work nor function properly.	The remote control may be operated outside its operation range.	For information on the remote control operation range, refer to "Using the remote control".	8
	The remote control sensor on this unit may be exposed to direct sunlight or lighting (invented fluorescent lamps).	Change the lighting or orientation of this unit.	—
	The battery may be worn out.	Replace the battery with new one.	8
	There are obstacles between the sensor of this unit and the remote control.	Remove the obstacles.	—

NOTES ABOUT DISCS/MP3, WMA FILES

■ Discs (audio CDs) playable with this unit

This player is designed for playing back compact discs bearing the marks shown below. Never attempt to load any other type of disc into the unit. The unit can also play back 8-cm (3-inch) compact discs.



.... Compact discs (digital audio)

The most popular discs for commercially available audio CDs.



.... CD-R, CD-RW digital audio discs

Music CDs made by copying onto a CD-R or CD-RW (including MP3 or WMA format files).



Notes

- Be sure to use a CD-R or CD-RW disc made by a reliable manufacture.
- Be sure to use a CD-R or CD-RW disc which has at least one of the following phrases on the disc or disc case.
FOR CONSUMER
FOR CONSUMER USE
FOR MUSIC USE ONLY
- Be sure to use a finalized CD-R or CD-RW disc.



.... CD-TEXT discs

The discs recorded with text data such as album titles, track titles and artist names.

Note

This compact disc player may not be able to play back some CD-RW discs or discs on which recording was not made correctly.

To prevent a malfunction of this unit:

- Do not use any nonstandard shaped disc (heart, etc.) available on the market because it might damage the unit.
- Do not use a disc with tape, stickers, or paste on it. If you use such a disc, the disc may get stuck in the unit, or damage to the unit may result.

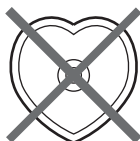

■ About MP3 and WMA files

You can play back MP3 and WMA files recorded on a CD-R/CD-RW and those stored on a USB device.

MP3

MP3 is a standard technology and format for compressing an audio sequence into a small-sized file. However, the original level of sound quality is preserved during playback.

The playable formats are:

- MPEG-1 Audio Layer-3
Bitrate*: 32-320 kbps
Sampling frequency: 44.1/48/32 kHz
 - MPEG-2 Audio Layer-3, 2
Bitrate*: 8-160 kbps
Sampling frequency: 24/22.05/16 kHz
- * Variable bitrate is supported.

WMA

“WMA (Windows Media Audio)” is a Microsoft file format for encoding digital audio files similar to MP3 though can compress files at a higher rate than MP3.

The playable formats are:

- Version 8
 - Version 9 (Standard and variable bitrates are supported. Professional and Lossless are not supported.)
 - High Profile
Bitrate*: 32-320 kbps
Sampling frequency: 48/44.1/32 kHz
 - Mid Profile
Bitrate: 16-32 kbps
Sampling frequency: 22.05/16 kHz
- * Both constant and variable bitrates are supported.

Notes

- Playback for Data Disc starts in alphanumeric order of files.
- Playback for USB starts in order by date and time of file creation.
- Copyright-protected WMA (DRM) files cannot be played back by this unit.
- The disc must be ISO9660 compatible.
- The maximum file and folder numbers are as follows.

	Data Disc	USB
Maximum total number of file and folder*	512	9,999
Maximum folder number*	255	255
Maximum file number per folder	511	255

* The root is counted as one of the folders.

■ Notes about handling compact discs

- Always handle a disc with care so that its surface is not scratched.

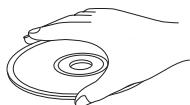

- Compact discs are not subjected to wear during playback, but damage to the disc surface when the disc is being handled can adversely affect the disc playback.
- Be sure to use a felt-tip pen or similar writing tool when writing on the label side of the disc. Do not use a ballpoint pen, pencil, or other hard-tipped writing tool, as these may damage the disc and may adversely affect the disc playback.
- Do not warp discs.
- When a disc is not being used, remove it from the unit and store in an appropriate case.
- When removing or storing a disc, be careful not to scratch the playing surface.
- Compact discs are not affected by small particles of dust or fingerprints on their playing surface, but even so they should be kept clean. Wipe by using a clean, dry cloth.

Do not wipe with a circular motion; wipe straight outward from the center.

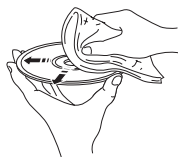

- Do not try to clean the disc's surface by using any type of disc cleaner, record spray, anti-static spray or liquid, or any other chemical-based liquid because such substances might irreparably damage the disc's surface.
- Do not expose discs to direct sunlight, high temperature or high humidity for a long period of time, as these might warp or otherwise damage the disc.



To play back an 8-cm (3-inch) CD

Place it in the inner recessed area of the disc tray. Do not put a normal (12-cm) CD on top of an 8-cm (3-inch) CD.

Note: Do not use any lens cleaners as they may be a cause of malfunction.

GLOSSARY

Audio information

■ MP3 (MPEG Audio Layer-3)

One of the audio compression methods used by MPEG. It employs the irreversible compression method, which achieves a high compression rate by thinning out the data of hardly audible part to the human ears. It is said to be capable of compressing the data quantity by about 1/11 (128 kbps) while maintaining a similar audio quality to music CD.

■ PCM (Pulse Code Modulation)

A signal that is changed to digital format without compression. A CD is recorded with 16-bit sound at 44.1 kHz. This signal also has a type called Packed PCM (PPCM) that can be compressed without any loss of data.

■ Sampling frequency

The number of sampling (process for digitalizing analog signals) per second. In principle, the higher the sampling rate, the wider the frequency range that can be played back, and the higher the quantized bit rate, the finer the sound that can be reproduced.

■ Track

A CD can be divided into a number of segments (tracks). Each division is called a track number.

■ WMA (Windows Media Audio)

An audio compression method developed by Microsoft Corporation. It employs the irreversible compression method, which achieves a high compression rate by thinning out the data of hardly audible part to the human ears. It is said to be capable of compressing the data quantity by about 1/22 (64 kbps) while maintaining a similar audio quality to music CD.

Copyright and logo marks

MPEG Layer-3 audio decoding technology licensed from Fraunhofer IIS and Thomson Multimedia.

iPod™

“iPod” is a trademark of Apple Inc., registered in the U.S. and other countries.

SPECIFICATIONS

■ PLAYER SECTION

Playback System

- CD, CD-R/RW

Laser

- Type Semiconductor laser GaAs/GaAlAs
- Wave length 780 nm
- Output power 10 mW

Audio Performance

- DAC 192 kHz/24 bit

■ AMPLIFIER SECTION

- Maximum RMS output power per channel (6 Ω, 1 kHz, 10% THD) 20 W + 20 W
- Total harmonic distortion (1 kHz) CD 10W, 6Ω 0.03 %
- Output level/Impedance PHONES (volume max) 0.6 V/32 Ω

■ TUNER SECTION

FM

- Tuning Range [U.S.A and Canada models] 87.5 to 107.9 MHz [Other models] 87.50 to 108.00 MHz
- Sensitivity FM (S/N 30 dB) 7dBμV/m (EMF)

■ GENERAL

- Power Supply [U.S.A. and Canada models] AC 120 V, 60 Hz [Australia model] AC 240 V, 50 Hz [Asia model] AC 220-240 V, 50/60 Hz [China model] AC 220 V, 50 Hz [Korea model] AC 220 V, 60 Hz [Taiwan model] AC 110-120 V, 60 Hz
- Power consumption 25 W
- Standby Power consumption* 1 W or less
- Dimensions (W x H x D) 180 x 117 x 303 mm (7-1/16 x 4-5/8 x 11-15/16 in)
- Weight 3.1 kg (6 lbs. 13 oz.)

* When ECO MODE is ON.

Specifications are subject to change without notice.

