

1756 ControlLogix Power Supplies Specifications

Standard Power Supplies Catalog Numbers 1756-PA72, 1756-PA75, 1756-PB72, 1756-PB75, 1756-PC75, 1756-PH75

ControlLogix-XT Power Supplies Catalog Numbers 1756-PAXT, 1756-PBXT

Redundant Power Supplies Catalog Numbers 1756-PA75R, 1756-PB75R

Chassis Adapter Module Catalog Number 1756-PSCA2

Topic	Page
Standard AC Power Supplies	2
Standard DC Power Supplies	4
1756 ControlLogix-XT Power Supplies	7
Redundant Power Supplies	9

ControlLogix® power supplies are used with the 1756 chassis to provide 1.2V, 3.3V, 5V, and 24V DC power directly to the chassis backplane. Standard, ControlLogix-XT™, and redundant power supplies are available.



Standard AC Power Supplies

Attribute	1756-PA72/C	1756-PA75/B
Input voltage range	85...265V AC	
Input voltage, nom	120V/240V AC	
Input frequency range	47...63 Hz	
Input power, max	100VA/100 W	
Output power, max	75 W @ 0...60 °C (32...140 °F) ⁽²⁾	
Power consumption	25 W @ 0...60 °C (32...140 °F)	
Power dissipation	85.3 BTU/hr	
Hold-up time ⁽¹⁾	5 cycles @ 85V AC, 50/60 Hz 6 cycles @ 120V AC, 50/60 Hz 6 cycles @ 200V AC, 50/60 Hz 6 cycles @ 240V AC, 50/60 Hz	
Inrush current, max	20 A	
Current capacity at 1.2V DC	1.5 A	
Current capacity at 3.3V DC	4 A	
Current capacity at 5.1V DC	10 A	13 A
Current capacity at 24V DC	2.8 A	
Overcurrent protection, max	User-supplied 15 A ⁽³⁾	
Fusing	Non-replaceable fuse is soldered in place ⁽⁴⁾	
Transformer load, max	100VA	
Isolation voltage	250V (continuous), reinforced insulation type Type tested @ 3500V DC for 60 s, power input-to-backplane	
Weight, approx.	0.95 kg (2.10 lb)	
Dimensions	140 x 112 x 145 mm (5.51 x 4.41 x 5.71 in.)	
Module location	Left side of 1756 chassis	
Chassis	1756-A4, 1756-A7, 1756-A10, 1756-A13, 1756-A17	
Chassis compatibility	Series A Series B	Series B
Wire size	2.5 mm ² (14 AWG) solid or stranded copper wire rated at 90 °C (194 °F), or greater, 1.2 mm (3/64 in.) insulation max	
Wire category	1 - on power ports ⁽⁵⁾	
Conductor screw torque	0.8 N·m (7 lb·in)	
North American temperature code	T4	
Enclosure type rating	None (open-style)	

(1) The hold-up time is the time between input voltage removal and DC power failure.

(2) The combination of all output power (5.1V backplane, 24V backplane, 3.3V backplane, and 1.2V backplane) cannot exceed 75 W.

(3) Use time-delay type overcurrent protection in all ungrounded conductors.

(4) This fuse is intended to guard against fire hazard due to short circuit conditions.

(5) Use this conductor category information for planning conductor routing as described in the system level installation manual. See the Industrial Automation Wiring and Grounding Guidelines, publication [1770-4.1](#).

Attribute	1756-PA72/C, 1756-PA75/B
Temperature, operating IEC 60068-2-1 (Test Ad, Operating Cold), IEC 60068-2-2 (Test Bd, Operating Dry Heat), IEC 60068-2-14 (Test Nb, Operating Thermal Shock)	0...60 °C (32...140 °F)
Temperature, surrounding air, max	60 °C (140 °F)
Temperature, non-operating IEC 60068-2-1 (Test Ab, Unpackaged Nonoperating Cold), IEC 60068-2-2 (Test Bb, Unpackaged Nonoperating Dry Heat), IEC 60068-2-14 (Test Na, Unpackaged Nonoperating Thermal Shock)	-40...85 °C (-40...185 °F)
Relative humidity IEC 60068-2-30 (Test Db, Unpackaged Damp Heat)	5...95% noncondensing
Vibration IEC 60068-2-6 (Test Fc, Operating)	2 g @ 10...500 Hz
Shock, operating IEC 60068-2-27 (Test Ea, Unpackaged Shock)	30 g
Shock, nonoperating IEC 60068-2-27 (Test Ea, Unpackaged Shock)	50 g
Emissions CISPR 11 (IEC 61000-6-4)	Class A
ESD immunity IEC 61000-4-2	6 kV contact discharges 8 kV air discharges
Radiated RF immunity IEC 61000-4-3	10V/m with 1 kHz sine-wave 80% AM from 80...2000 MHz 10V/m with 200 Hz 50% Pulse 100% AM @ 900 MHz 10V/m with 200 Hz 50% Pulse 100% AM @ 1890 MHz 3V/m with 1kHz sine-wave 80% AM from 2000...2700 MHz
EFT/B immunity IEC 61000-4-4	±4 kV at 5 kHz on power ports
Surge transient immunity IEC 61000-4-5	±1 kV line-line (DM) and ±2 kV line-earth (CM) on power ports
Conducted RF immunity IEC 61000-4-6	10 Vrms with 1 kHz sine-wave 80% AM from 150 kHz...80 MHz
Oscillatory surge withstand IEEE C37.90.1	3 kV
Voltage variation IEC 61000-4-11	30% dips for 1 period at 0° and 80° on AC supply ports 60% dips for 5 and 50 periods on AC supply ports ±10% fluctuations for 15 min on AC supply ports >95% interruptions for 250 periods on AC supply ports

Certification ⁽¹⁾	1756-PA72/C, 1756-PA75/B
UL	UL Listed Industrial Control Equipment. See UL File E65584.
CSA	CSA Certified Process Control Equipment. See CSA File LR54689C. CSA Certified Process Control Equipment for Class I, Division 2 Group A,B,C,D Hazardous Locations. See CSA File LR69960C.
FM	FM Approved Equipment for use in Class I Division 2 Group A,B,C,D Hazardous Locations
CE	European Union 2004/108/EC EMC Directive, compliant with: EN 61326-1; Meas./Control/Lab., Industrial Requirements EN 61000-6-2; Industrial Immunity EN 61000-6-4; Industrial Emissions EN 61131-2; Programmable Controllers (Clause 8, Zone A & B) European Union 2006/95/EC LVD, compliant with: EN 61131-2; Programmable Controllers (Clause 11)
C-Tick	Australian Radiocommunications Act, compliant with: AS/NZS CISPR 11; Industrial Emissions
KC	Korean Registration of Broadcasting and Communications Equipment, compliant with: Article 58-2 of Radio Waves Act, Clause 3

(1) When marked. See the Product Certification link at <http://www.ab.com> for Declarations of Conformity, Certificates, and other certification details.

Standard DC Power Supplies

Attribute	1756-PB72/C	1756-PB75/B	1756-PC75/B	1756-PH75/B
Input voltage range	18...32V DC		30...60V DC	90...143V DC
Input voltage, nom	24V DC		48V DC	125V DC
Input power, max	95 W			
Output power, max	75 W @ 0...60 °C (32...140 °F) ⁽²⁾			
Power consumption	20 W @ 0...60 °C (32...140 °F)			
Power dissipation	68.2 BTU/hr			
Hold-up time ⁽¹⁾	35 ms @ 18V DC 40 ms @ 24V DC 40 ms @ 32V DC		50 ms @ 30...60V DC nom	50 ms @ 90...143V DC nom
Inrush current, max	30 A		20 A	
Current capacity at 1.2V	1.5 A			
Current capacity at 3.3V	4 A			
Current capacity at 5.1V	10 A	13 A		
Current capacity at 24V	2.8 A			
Overcurrent protection, max	User-supplied 15 A ⁽³⁾			
Fusing	Non-replaceable fuse is soldered in place ⁽⁴⁾			
Isolation voltage	250V (continuous), reinforced insulation type, power input-to-backplane Type tested @ 3500V DC for 60 s			
Weight, approx.	0.95 kg (2.10 lb)			
Dimensions	140 x 112 x 145 mm (5.51 x 4.41 x 5.71 in.)			
Module location	Left side of 1756 chassis			
Chassis	1756-A4, 1756-A7, 1756-A10, 1756-A13, 1756-A17			
Chassis compatibility	Series A Series B	Series B		
Wire size	2.5 mm ² (14 AWG) solid or stranded copper wire rated at 90 °C (194 °F), or greater, 1.2 mm (3/64 in.) insulation max			
Wire category	1 - on power ports ⁽⁵⁾			
Conductor screw torque	0.8 N•m (7 lb•in)			
North American temperature code	T4			
IEC temperature code	T4		N/A	
Enclosure type rating	None (open-style)			

(1) The hold-up time is the time between input voltage removal and DC power failure.

(2) The combination of all output power (5.1V backplane, 24V backplane, 3.3V backplane, and 1.2V backplane) cannot exceed 75 W.

(3) Use time-delay type overcurrent protection in all ungrounded conductors.

(4) This fuse is intended to guard against fire hazard due to short circuit conditions.

(5) Use this conductor category information for planning conductor routing as described in the system level installation manual. See the Industrial Automation Wiring and Grounding Guidelines, publication [1770-4.1](#).

Attribute	1756-PB72/C, 1756-PB75/B	1756-PC75/B, 1756-PH75/B
Temperature, operating IEC 60068-2-1 (Test Ad, Operating Cold), IEC 60068-2-2 (Test Bd, Operating Dry Heat), IEC 60068-2-14 (Test Nb, Operating Thermal Shock)	0...60 °C (32...140 °F)	
Temperature, surrounding air, max	60 °C (140 °F)	
Temperature, nonoperating IEC 60068-2-1 (Test Ab, Unpackaged Nonoperating Cold), IEC 60068-2-2 (Test Bb, Unpackaged Nonoperating Dry Heat), IEC 60068-2-14 (Test Na, Unpackaged Nonoperating Thermal Shock)	-40...85 °C (-40...185 °F)	
Relative humidity IEC 60068-2-30 (Test Db, Unpackaged Damp Heat)	5...95% noncondensing	
Vibration IEC 60068-2-6 (Test Fc, Operating)	2 g @ 10...500 Hz	
Shock, operating IEC 60068-2-27 (Test Ea, Unpackaged Shock)	30 g	
Shock, nonoperating IEC 60068-2-27 (Test Ea, Unpackaged Shock)	50 g	
Emissions CISPR 11 (IEC 61000-6-4)	Class A	
ESD immunity IEC 61000-4-2	6 kV contact discharges 8 kV air discharges	
Radiated RF immunity IEC 61000-4-3	10V/m with 1 kHz sine-wave 80% AM from 80...2000 MHz 10V/m with 200 Hz 50% Pulse 100% AM @ 900 MHz 10V/m with 200 Hz 50% Pulse 100% AM @ 1890 MHz 3V/m with 1 kHz sine-wave 80% AM from 2000...2700 MHz	
EFT/B immunity IEC 61000-4-4	±4 kV at 5 kHz on power ports	
Surge transient immunity IEC 61000-4-5	±1 kV line-line (DM) and ±2 kV line-earth (CM) on power ports	
Conducted RF immunity IEC 61000-4-6	10 Vrms with 1 kHz sine-wave 80% AM from 150 kHz...80 MHz	
Oscillatory surge withstand IEEE C37.90.1	N/A	3 kV
Voltage variation IEC 61000-4-29	60% dips for 100 ms on DC supply ports 100% dips for 50 ms on DC supply ports ±20% fluctuations for 15 min on DC supply ports 5 s interruptions on DC supply ports 10 ms interruption on DC supply ports	

Certification⁽¹⁾	1756-PB72/C, 1756-PB75/B	1756-PC75/B, 1756-PH75/B
UL	N/A	UL Listed Industrial Control Equipment. See UL File E65584.
c-UL-us	UL Listed Industrial Control Equipment, certified for US and Canada. See UL File E65584. UL Listed for Class I, Division 2 Group A,B,C,D Hazardous Locations, certified for US and Canada. See UL File E194810.	N/A
CSA	CSA Certified Process Control Equipment. See CSA File LR54689C. CSA Certified Process Control Equipment for Class I, Division 2 Group A,B,C,D Hazardous Locations. See CSA File LR69960C.	
FM	FM Approved Equipment for use in Class I Division 2 Group A,B,C,D Hazardous Locations	N/A
CE	European Union 2004/108/EC EMC Directive, compliant with: <ul style="list-style-type: none"> • EN 61326-1; Meas./Control/Lab., Industrial Requirements • EN 61000-6-2; Industrial Immunity • EN 61000-6-4; Industrial Emissions • EN 61131-2; Programmable Controllers (Clause 8, Zone A & B) European Union 2006/95/EC LVD, compliant with: <ul style="list-style-type: none"> • EN 61131-2; Programmable Controllers (Clause 11) 	
C-Tick	Australian Radiocommunications Act, compliant with: AS/NZS CISPR 11; Industrial Emissions	
Ex	European Union 94/9/EC ATEX Directive, compliant with: <ul style="list-style-type: none"> • EN 60079-15; Potentially Explosive Atmospheres, Protection "n" • EN 60079-0; General Requirements • II 3 G Ex nA IIC T4 Gc X 	N/A
KC	Korean Registration of Broadcasting and Communications Equipment, compliant with: Article 58-2 of Radio Waves Act, Clause 3	

(1) When marked. See the Product Certification link at <http://www.ab.com> for Declarations of Conformity, Certificates, and other certification details.

1756 ControlLogix-XT Power Supplies

The ControlLogix-XT products include control and communication system components that, when used with FLEX I/O-XT™ products, provide a complete control system solution that you can use in environments where temperatures range from -20...70 °C (-4...158 °F).

When used independently, the ControlLogix-XT system can withstand environments where the temperature ranges from -25...70 °C (-13...158 °F).

Attribute	1756-PAXT	1756-PBXT
Input voltage range	85...265V AC	18...32V DC
Input voltage, nom	120/240V AC	24V DC
Input frequency range	47...63 Hz	N/A
Input power, max	82VA 64 W	54 W
Output power, max	42 W @ -25...70 °C (-13...158 °F)	
Power consumption	22 W	12 W
Power dissipation	75.1 BTU/hr	40.9 BTU/hr
Hold-up time ⁽¹⁾	6 cycles @ 85V AV, 50/60 Hz 6 cycles @ 120V AV, 50/60 Hz 6 cycles @ 200V AV, 50/60 Hz 6 cycles @ 240V AV, 50/60 Hz	35 ms @ 18V DC 40 ms @ 24V DC 40 ms @ 32V DC
Inrush current, max	20 A	30 A
Current capacity at 1.2V	1.5 A	
Current capacity at 3.3V	4 A	
Current capacity at 5.1V	8 A	
Current capacity at 24V	1.75 A	
Overcurrent protection, max	User-supplied 15 A ⁽²⁾	
Fusing	Non-replaceable fuse is soldered in place ⁽³⁾	
Isolation voltage	250V (continuous), reinforced insulation type, power input-to-backplane Type tested @ 3260V DC for 60 s	
Weight, approx.	0.95 kg (2.10 lb)	
Dimensions	140 x 112 x 145 mm (5.51 x 4.41 x 5.71 in.)	
Module location	Left side of 1756 chassis	
Chassis	1756-A4LXT, 1756-A5XT, 1756-A7LXT, 1756-A7XT	
Wire size	2.5 mm ² (14 AWG) solid or stranded copper wire rated at 90 °C (194 °F), or greater, 1.2 mm (3/64 in.) insulation max	
Wire category	1 - on power ports ⁽⁴⁾	
Conductor screw torque	0.8 N•m (7 lb•in)	
North American temperature code	T4	T4A
IEC temperature code	T4	
Enclosure type rating	None (open-style)	

(1) The hold-up time is the time between input voltage removal and DC power failure.

(2) Use time-delay type overcurrent protection in all ungrounded conductors.

(3) This fuse is intended to guard against fire hazard due to short circuit conditions.

(4) Use this conductor category information for planning conductor routing as described in the system level installation manual. See the Industrial Automation Wiring and Grounding Guidelines, publication [1770-4.1](#).

Attribute	1756-PAXT	1756-PBXT
Temperature, operating IEC 60068-2-1 (Test Ad, Operating Cold), IEC 60068-2-2 (Test Bd, Operating Dry Heat), IEC 60068-2-14 (Test Nb, Operating Thermal Shock)	-25...70 °C (-13...158 °F)	
Temperature, surrounding air, max	70 °C (158 °F)	
Temperature, nonoperating IEC 60068-2-1 (Test Ab, Unpackaged Nonoperating Cold), IEC 60068-2-2 (Test Bb, Unpackaged Nonoperating Dry Heat), IEC 60068-2-14 (Test Na, Unpackaged Nonoperating Thermal Shock)	-40...85 °C (-40...185 °F)	
Relative humidity IEC 60068-2-30 (Test Db, Unpackaged Damp Heat)	5...95% noncondensing	
Vibration IEC 60068-2-6 (Test Fc, Operating)	2 g @ 10...500 Hz	
Shock, operating IEC 60068-2-27 (Test Ea, Unpackaged Shock)	30 g	
Shock, nonoperating IEC 60068-2-27 (Test Ea, Unpackaged Shock)	50 g	
Emissions CISPR 11 (IEC 61000-6-4)	Class A	
ESD immunity IEC 61000-4-2	6 kV contact discharges 8 kV air discharges	
Radiated RF immunity IEC 61000-4-3	10V/m with 1 kHz sine-wave 80% AM from 80...2000 MHz 10V/m with 200 Hz 50% Pulse 100% AM at 900 MHz 10V/m with 200 Hz 50% Pulse 100% AM at 1890 MHz 3V/m with 1 kHz sine-wave 80% AM from 2000...2700 MHz	
EFT/B immunity IEC 61000-4-4	±4 kV at 5 kHz on power ports	
Surge transient immunity IEC 61000-4-5	±1 kV line-line (DM) and ±2 kV line-earth (CM) on power ports	
Conducted RF immunity IEC 61000-4-6	10 Vrms with 1 kHz sine-wave 80% AM from 150 kHz...80 MHz	
Oscillatory surge withstand IEEE C37.90.1	3 kV	N/A
Voltage variation IEC 61000-4-11	30% dips for 1 period at 0° and 180° on AC supply ports 60% dips for 5 and 50 periods on AC supply ports ±10% fluctuations for 15 min on AC supply ports >95% interruptions for 250 periods on AC supply ports	N/A
Voltage variation IEC 61000-4-29	NA	60% dips for 100 ms on DC supply ports 100% dips for 50 ms on DC supply ports ±20% fluctuations for 15 min on DC supply ports 5 s interruptions on DC supply ports 10 ms interruption on DC supply ports

Certification ⁽¹⁾	1756-PAXT, 1756-PBXT
c-UL-us	UL Listed Industrial Control Equipment, certified for US and Canada. See UL File E65584. UL Listed for Class I, Division 2 Group A,B,C,D Hazardous Locations, certified for US and Canada. See UL File E194810.
CE	European Union 2004/108/EC EMC Directive, compliant with: <ul style="list-style-type: none"> EN 61326-1; Meas./Control/Lab., Industrial Requirements EN 61000-6-2; Industrial Immunity EN 61000-6-4; Industrial Emissions EN 61131-2; Programmable Controllers (Clause 8, Zone A & B) European Union 2006/95/EC LVD, compliant with: <ul style="list-style-type: none"> EN 61131-2; Programmable Controllers (Clause 11)
C-Tick	Australian Radiocommunications Act, compliant with: AS/NZS CISPR 11; Industrial Emissions
Ex	European Union 94/9/EC ATEX Directive, compliant with: <ul style="list-style-type: none"> EN 60079-15; Potentially Explosive Atmospheres, Protection "n" EN 60079-0; General Requirements II 3 G Ex nA IIC T4 Gc X
KC	Korean Registration of Broadcasting and Communications Equipment, compliant with: Article 58-2 of Radio Waves Act, Clause 3

(1) When marked. See the Product Certification link at <http://www.ab.com> for Declarations of Conformity, Certificates, and other certification details.

Redundant Power Supplies

To build a redundant power supply system, you need the following.

Cat. No.	Description	Amount
1756-PA75R/A or 1756-PB75R/A	Redundant power supply	2
1756-CPR2	Redundant power supply cable (Length = 0.9 1m [3 ft])	2
1756-PSCA2	Redundant power supply chassis adapter module ⁽¹⁾	1
User-supplied	Annunciator wiring ⁽²⁾ (Max. length = 10 m [32.8 ft])	2

(1) The 1756-PSCA2 chassis adapter module is a passive device that funnels power from the redundant power supplies to the single power connector on the ControlLogix series B chassis backplane.

(2) Optional user-provided annunciator wiring can be connected to the solid-state relay for status and troubleshooting purposes.

System Configuration Recommendations

We recommend you use one of these methods to configure your redundant power supply system.

Recommended Configurations for a System That Uses One Chassis

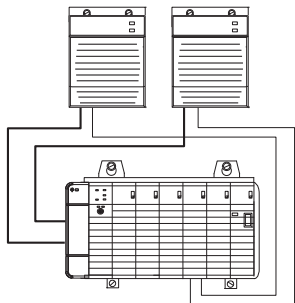

42655

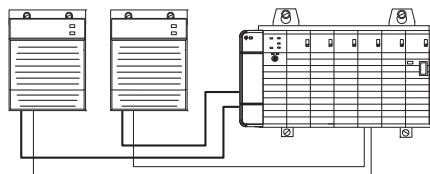

42657

Recommended Configurations for a System That Uses Two Chassis

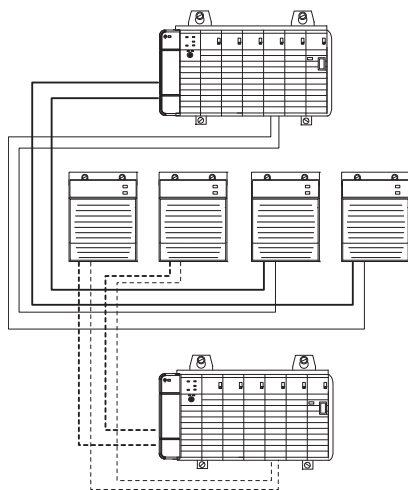

42658

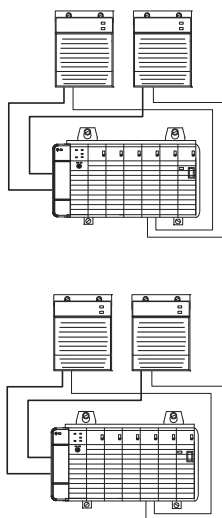

42655

1756-PA75R and 1756-PB75R Mounting Dimensions

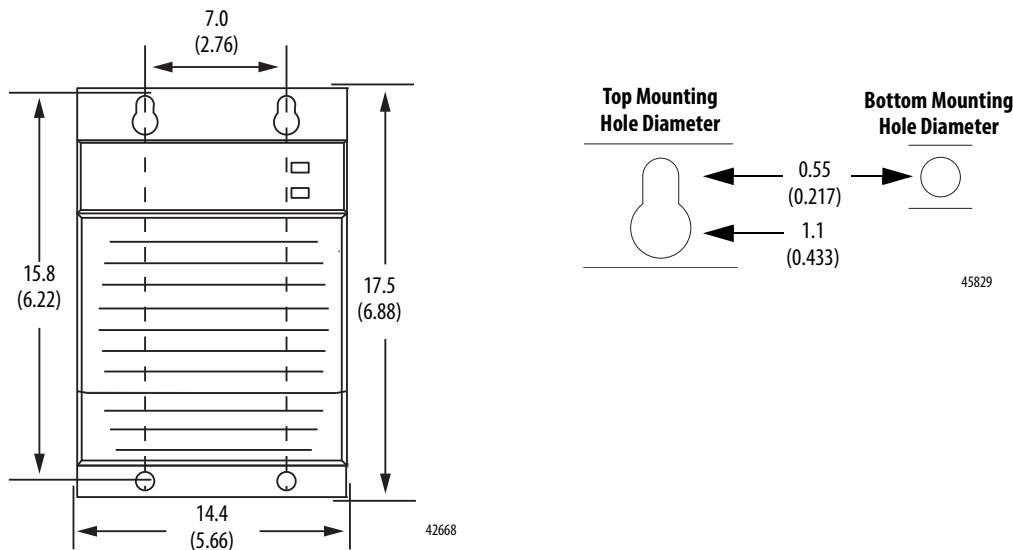

Dimensions are in cm (in.).

Redundant Power Supply Features

The redundant power supplies offer the same features as the standard power supplies, in addition to the following:

- Automatic chassis load sharing between the redundant power supplies
- Status indicators for visual operating status of the pair
- Solid-state relay for system recognition of supply status when wired to an input module

Table 1 - Technical Specifications - ControlLogix Redundant Power Supplies

Attribute	1756-PA75R	1756-PB75R
Input voltage range	85...265V AC	19.2...32V DC
Input voltage	120V/240V AC	24V DC
Input frequency range	47...63 Hz	DC
Input power, max	120VA 115 W	110 W
Output power, max	75 W @ 0...60 °C (32...140 °F)	
Hold-up time ⁽¹⁾	2 cycles @ 60 Hz 2 cycles @ 50 Hz	20 ms
Inrush current, max	20 A	30 A
Current capacity at 1.2V	1.5 A	
Current capacity at 3.3V	4 A	
Current capacity at 5.1V	13 A	
Current capacity at 24V	2.8 A	
Annunciator power	240V AC/DC, 50 mA, Resistive only	
Overcurrent protection, max	User-supplied 15 A ⁽²⁾	
Fusing	Non-replaceable fuse is soldered in place ⁽³⁾	
Isolation voltage	250V (continuous), Reinforced Insulation Type, Power Input to Backplane, Power Input to Annunciator, Annunciator to Backplane Type tested at 2500V DC for 60 s	

Table 1 - Technical Specifications - ControlLogix Redundant Power Supplies

Attribute	1756-PA75R	1756-PB75R
Dimensions (HxWxD), approx.	175 x 145 x 137 mm (6.9 x 5.7 x 5.4 in.)	
Weight, approx.	1.45 kg (3.2 lb)	
Chassis	1756-A4, 1756-A7, 1756-A10, 1756-A13, 1756-A17	
Wire Size	Power - 2.5 mm ² (14 AWG) solid or stranded copper wire rated at 90 °C (194 °F), or greater, 1.2 mm (3/64 in.) insulation max Annunciator - 0.25...2.5 mm ² (22...14 AWG) solid or stranded copper wire rated at 90 °C (194 °F), or greater, 1.2 mm (3/64 in.) insulation max	
Wire category ⁽⁴⁾	1 - on power ports 3 - on annunciator ports 3 - on 1756-CPR2 connections	
Pilot duty rating	Annunciator - not rated	
Conductor screw torque	0.79 N·m (7 lb·in)	
Solid-state relay contact	240V AC/DC ⁽⁵⁾	
North American temperature code	T3C	T4
IEC temperature code	N/A	T4
Enclosure type rating	None (open-style)	

- (1) The hold-up time is the time between input voltage removal and DC power failure.
(2) Use time-delay type overcurrent protection in all ungrounded conductors.
(3) This fuse is intended to guard against fire hazard due to short circuit conditions.
(4) Use this conductor category information for planning conductor routing as described in the system level installation manual. See the Industrial Automation Wiring and Grounding Guidelines, publication [1770-4.1](#).
(5) Do not exceed 50 mA; resistive only.

Attribute	1756-PA75R	1756-PB75R
Temperature, operating IEC 60068-2-1 (Test Ad, Operating Cold), IEC 60068-2-2 (Test Bd, Operating Dry Heat), IEC 60068-2-14 (Test Nb, Operating Thermal Shock)	0...60 °C (32...140 °F)	
Temperature, surrounding air, max	60 °C (140 °F)	
Temperature, nonoperating IEC 60068-2-1 (Test Ab, Unpackaged Nonoperating Cold), IEC 60068-2-2 (Test Bb, Unpackaged Nonoperating Dry Heat), IEC 60068-2-14 (Test Na, Unpackaged Nonoperating Thermal Shock)	-40...85 °C (-40...185 °F)	
Relative humidity IEC 60068-2-30 (Test Db, Unpackaged Damp Heat)	5...95% noncondensing	
Vibration IEC 60068-2-6 (Test Fc, Operating)	2 g @ 10...500 Hz	
Shock, operating IEC 60068-2-27 (Test Ea, Unpackaged Shock)	30 g	
Shock, nonoperating IEC 60068-2-27 (Test Ea, Unpackaged Shock)	50 g	
Emissions CISPR 11 (IEC 61000-6-4)	Class A	
ESD immunity IEC 61000-4-2	6 kV contact discharges 8 kV air discharges	
Radiated RF immunity IEC 61000-4-3	10V/m with 1 kHz sine-wave 80% AM from 30... 1000 MHz 10V/m with 200 Hz 50% Pulse 100% AM @ 900 MHz 10V/m with 200 Hz 50% Pulse 100% AM at 1890 MHz 3V/m with 1 kHz sine-wave 80% AM from 2000... 2700 MHz	
EFT/B immunity IEC 61000-4-4	±4 kV at 5 kHz on power ports ±4 kV at 5 kHz on annunciator ports	
Surge transient immunity IEC 61000-4-5	±1 kV line-line (DM) and ±2 kV line-earth (CM) on power ports	

Attribute	1756-PA75R	1756-PB75R
Conducted RF immunity IEC 61000-4-6	10 Vrms with 1 kHz sine-wave 80% AM from 150 kHz...80 MHz	
Voltage variation IEC 61000-4-11	30% dips for 1 period at 0° and 180° on AC supply ports 60% dips for 5 and 50 periods on AC supply ports ±10% fluctuations for 15 min on AC supply ports >95% interruptions for 250 periods on AC supply ports\	N/A
Voltage variation IEC 61000-4-29	NA	60% dips for 100 ms on DC supply ports 100% dips for 50 ms on DC supply ports ±20% fluctuations for 15 min on DC supply ports 5 s interruptions on DC supply ports 10 ms interruption on DC supply ports
Certification ⁽¹⁾	1756-PA75R	1756-PB75R
c-UL-us	UL Listed Industrial Control Equipment, certified for US and Canada. See UL File E65584. UL Listed for Class I, Division 2 Group A,B,C,D Hazardous Locations, certified for U.S. and Canada. See UL File E194810.	
CSA	CSA Certified Process Control Equipment. See CSA File LR54689C. CSA Certified Process Control Equipment for Class I, Division 2 Group A,B,C,D Hazardous Locations. See CSA File LR69960C.	
FM	FM Approved Equipment for use in Class I Division 2 Group A,B,C,D Hazardous Locations	
CE	European Union 2004/108/EC EMC Directive, compliant with: EN 61326-1; Meas./Control/Lab., Industrial Requirements EN 61000-6-2; Industrial Immunity EN 61000-6-4; Industrial Emissions EN 61131-2; Programmable Controllers (Clause 8, Zone A & B) European Union 2006/95/EC LVD, compliant with: EN 61131-2; Programmable Controllers (Clause 11)	
C-Tick	Australian Radiocommunications Act, compliant with: AS/NZS CISPR 11; Industrial Emissions	
Ex	N/A	European Union 94/9/EC ATEX Directive, compliant with: • EN 60079-15; Potentially Explosive Atmospheres, Protection "n" • EN 60079-0; General Requirements • II 3 G Ex nA IIC T4 Gc X
KC	Korean Registration of Broadcasting and Communications Equipment, compliant with: Article 58-2 of Radio Waves Act, Clause 3	

(1) When marked. See the Product Certification link at <http://www.ab.com> for Declarations of Conformity, Certificates, and other certification details.

ControlLogix Redundant Power Supply Chassis Adapter Module

Table 2 - Technical Specifications - ControlLogix Redundant Power Supplies Chassis Adapter Module

Attribute	1756-PSCA2
Current capacity at 1.2V DC	1.5 A
Current capacity at 3.3V DC	4 A
Current capacity at 5.1V DC	15 A
Current capacity at 24V DC	2.8 A
Wire category ⁽¹⁾	3 - on 1756-CPR2 connections
North American temperature code	T5
IEC temperature code	T5
Enclosure type rating	None (open-style)

(1) Use this conductor category information for planning conductor routing as described in the system level installation manual. See the Industrial Automation Wiring and Grounding Guidelines, publication [1770-4.1](#).

Attribute	1756-PSCA2
Temperature, operating IEC 60068-2-1 (Test Ad, Operating Cold), IEC 60068-2-2 (Test Bd, Operating Dry Heat), IEC 60068-2-14 (Test Nb, Operating Thermal Shock)	0...60 °C (32...140 °F)
Temperature, surrounding air, max	60 °C 140 °F)
Temperature, nonoperating IEC 60068-2-1 (Test Ab, Unpackaged Nonoperating Cold), IEC 60068-2-2 (Test Bb, Unpackaged Nonoperating Dry Heat), IEC 60068-2-14 (Test Na, Unpackaged Nonoperating Thermal Shock)	-40...85 °C (-40...185 °F)
Relative humidity IEC 60068-2-30 (Test Db, Unpackaged Damp Heat)	5...95% noncondensing
Vibration IEC 60068-2-6 (Test Fc, Operating)	2 g @ 10...500 Hz
Shock, operating IEC 60068-2-27 (Test Ea, Unpackaged Shock)	30 g
Shock, nonoperating IEC 60068-2-27 (Test Ea, Unpackaged Shock)	50 g
Emissions CISPR 11 (IEC 61000-6-4)	Class A
ESD immunity IEC 61000-4-2	6 kV contact discharges 8 kV air discharges
Radiated RF immunity IEC 61000-4-3	10V/m with 1 kHz sine-wave 80% AM from 80...2000 MHz 10V/m with 200 Hz 50% Pulse 100% AM at 900 MHz 10V/m with 200 Hz 50% Pulse 100% AM at 1890 MHz 3V/m with 1 kHz sine-wave 80% AM from 2000...2700 MHz

Certification ⁽¹⁾	1756-PSCA2
c-UL-us	UL Listed Industrial Control Equipment, certified for US and Canada. See UL File E65584. UL Listed for Class I, Division 2 Group A,B,C,D Hazardous Locations, certified for U.S. and Canada. See UL File E194810.
CSA	CSA Certified Process Control Equipment. See CSA File LR54689C. CSA Certified Process Control Equipment for Class I, Division 2 Group A,B,C,D Hazardous Locations. See CSA File LR69960C.
FM	FM Approved Equipment for use in Class I Division 2 Group A,B,C,D Hazardous Locations
CE	European Union 2004/108/EC EMC Directive, compliant with: <ul style="list-style-type: none"> EN 61326-1; Meas./Control/Lab., Industrial Requirements EN 61000-6-2; Industrial Immunity EN 61000-6-4; Industrial Emissions EN 61131-2; Programmable Controllers (Clause 8, Zone A & B)
C-Tick	<ul style="list-style-type: none"> Australian Radiocommunications Act, compliant with: AS/NZS CISPR 11; Industrial Emissions
Ex	European Union 94/9/EC ATEX Directive, compliant with: <ul style="list-style-type: none"> EN 60079-15; Potentially Explosive Atmospheres, Protection "n" EN 60079-0; General Requirements II 3 G Ex nA IIC T5 Gc X
KC	Korean Registration of Broadcasting and Communications Equipment, compliant with: <ul style="list-style-type: none"> Article 58-2 of Radio Waves Act, Clause 3

(1) When marked. See the Product Certification link at <http://www.ab.com> for Declarations of Conformity, Certificates, and other certification details.

Power Load and Transformer Sizing

The following graphs show the input power requirements for the power supplies, given the power they are providing to the modules in the chassis.

Follow these steps to determine the power requirements for you chassis.

1. Calculate the Backplane Power Load by adding the power draw (in Watts) for all of the planned modules.

For module power draws, refer to the module specification tables in the ControlLogix Selection Guide, publication [1756-SG001](#).

2. Locate the Backplane Power Load on the graph's vertical (y) axis and determine the corresponding Real Power (input-power) rating on the horizontal (x) axis.

The Real Power value is the amount of power consumed by the power supply.

Power Supply Power Requirements

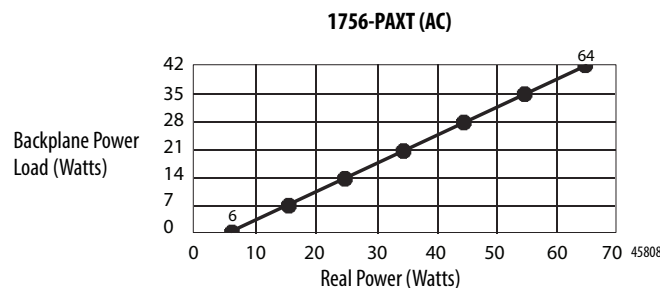
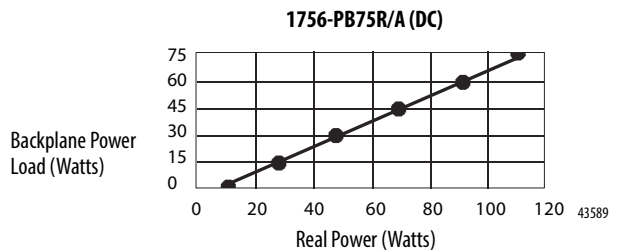
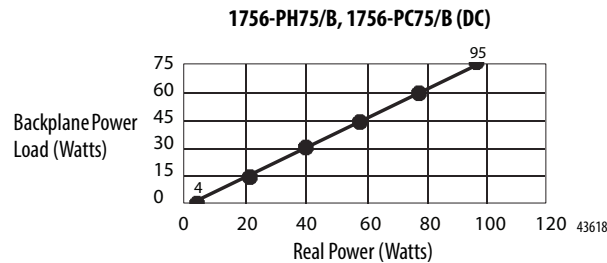
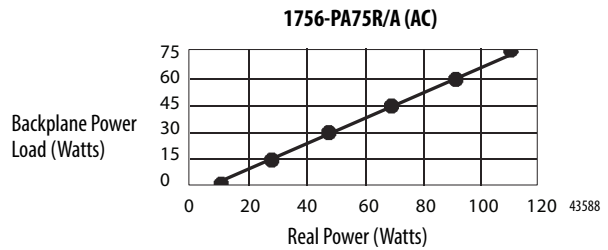
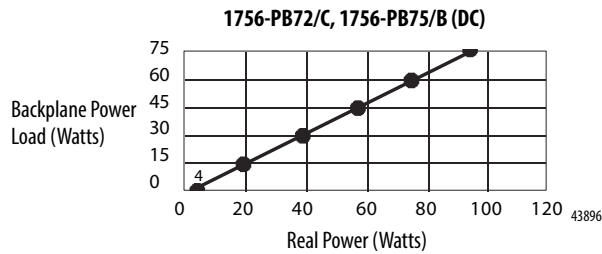
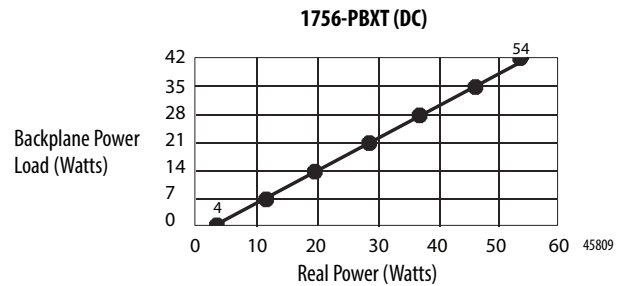
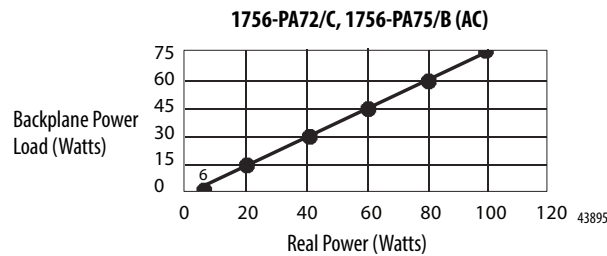

$$\text{Apparent Power (Watts)} = \text{Transformer Load (VA)} = \text{Real Power (Watts)}$$

Additional Resources

These documents contain additional information concerning related products from Rockwell Automation.

Resource	Description
ControlLogix Selection Guide, publication 1756-SG001	Provides overview of the ControlLogix system and its products.
ControlLogix Chassis Specifications Technical Data, publication 1756-TD006	Provides technical specifications for ControlLogix chassis.
ControlLogix Chassis and Power Supplies Installation Instructions, publication 1756-IN005	Provides planning and installation information for the ControlLogix chassis and power supplies.
ControlLogix System User Manual, publication 1756-UM001	Provides information on how to install, configure, program, and use ControlLogix systems.
Industrial Automation Wiring and Grounding Guidelines, publication 1770-4.1	Provides general guidelines for installing a Rockwell Automation industrial system.
Product Certifications website, http://www.ab.com	Provides declarations of conformity, certificates, and other certification details.

You can view or download publications at <http://www.rockwellautomation.com/literature/>. To order paper copies of technical documentation, contact your local Allen-Bradley distributor or Rockwell Automation sales representative.

Important User Information

Solid-state equipment has operational characteristics differing from those of electromechanical equipment. Safety Guidelines for the Application, Installation and Maintenance of Solid State Controls (publication [SGI-1.1](#) available from your local Rockwell Automation sales office or online at <http://www.rockwellautomation.com/literature/>) describes some important differences between solid-state equipment and hard-wired electromechanical devices. Because of this difference, and also because of the wide variety of uses for solid-state equipment, all persons responsible for applying this equipment must satisfy themselves that each intended application of this equipment is acceptable.

In no event will Rockwell Automation, Inc. be responsible or liable for indirect or consequential damages resulting from the use or application of this equipment.

The examples and diagrams in this publication are included solely for illustrative purposes. Because of the many variables and requirements associated with any particular installation, Rockwell Automation, Inc. cannot assume responsibility or liability for actual use based on the examples and diagrams.

No patent liability is assumed by Rockwell Automation, Inc. with respect to use of information, circuits, equipment, or software described in this manual.

Reproduction of the contents of this manual, in whole or in part, without written permission of Rockwell Automation, Inc., is prohibited.

Documentation Feedback

Your comments will help us serve your documentation needs better. If you have any suggestions on how to improve this document, complete this form, publication [RA-DU002](#), available at <http://www.rockwellautomation.com/literature/>.

Rockwell Automation, Rockwell Software, Allen-Bradley, ControlLogix, ControlLogix-XT, FLEX I/O-XT, and LISTEN.THINK.SOLVE. are trademarks of Rockwell Automation, Inc. Trademarks not belonging to Rockwell Automation are property of their respective companies.

Rockwell Otomasyon Ticaret A.Ş., Kar Plaza İş Merkezi E Blok Kat:6 34752 İçerenköy, İstanbul, Tel: +90 (216) 5698400

www.rockwellautomation.com

Power, Control and Information Solutions Headquarters

Americas: Rockwell Automation, 1201 South Second Street, Milwaukee, WI 53204-2496 USA, Tel: (1) 414.382.2000, Fax: (1) 414.382.4444
Europe/Middle East/Africa: Rockwell Automation NV, Pegasus Park, De Kleetlaan 12a, 1831 Diegem, Belgium, Tel: (32) 2 663 0600, Fax: (32) 2 663 0640
Asia Pacific: Rockwell Automation, Level 14, Core F, Cyberport 3, 100 Cyberport Road, Hong Kong, Tel: (852) 2887 4788, Fax: (852) 2508 1846

Publication 1756-TD005D-EN-E - March 2013

Supersedes Publication 1756-TD005C-EN-E - January 2012

Copyright © 2013 Rockwell Automation, Inc. All rights reserved. Printed in the U.S.A.