

Operation manual

WIWA Professional

Type: 24026

24053

24071

28023

28048

28064

38032

38042

44024

44032

Serial-No.

.....



1.1	Table of contents	
1	Contents	3
1.1	Table of contents	3
1.2	Preface	4
1.3	First read, then start	4
2	Safety	5
2.1	Description of symbols	5
2.2	Warning instructions located on the machine	5
2.3	Dangers arising from the equipment	5
2.4	Application of the machine	6
2.5	Machine surroundings	7
2.6	Sources of danger	7
2.7	Operating staff	8
2.8	Installation site	8
2.9	Behavior in case of emergency	9
2.10	Safety features	9
2.11	Pump handling and auxiliary materials	10
2.12	Transporting	10
3	Component description	11
4	Erection and assembly	12
5	Start-up	14
5.1	First cleaning	14
5.2	Checking pressure	15
6	Operation	16
6.1	Equipment preparation	16
6.2	Spray operation	17
6.3	Change of material	17
7	Shutting down	18
8	Maintenance	19
8.1	Regular inspections	19
8.2	Maintenance plan	19
8.3	High pressure filter	19
8.4	Maintenance unit	19
9	Malfunctions and troubleshooting	22
10	Appendix	23
10.1	Technical specifications	23
10.2	Auxiliary materials	23
10.3	Machine card	24
10.4	Certificate of training and operation	24

1.2 Preface



This User's Handbook must always be available to operating staff

The operating authority of the equipment must ensure, that a user's handbook is available to the operator, in a language which he understands.

Dear customer!

Thank you for your decision to purchase **WIWA**® equipment.

In the user's handbook, you can find all information required for the proper handling of your **WIWA**® Airless Paint Spraying Machine. However, for safe operation, there are further essential details which you should adhere to:

Please read and observe the guidelines valid for your country.

In Germany, the "**Richtlinien für Flüssigkeitsstrahler**" (Guidelines for fluid sprayers) published by: Hauptverband der Gewerblichen Berufsgenossenschaften (Industrial Employer's Liability Insurance Association), are valid.

Manufacturer's notes and operating guidelines for coating and pumping materials should be observed at all times.

No method of operation should be exercised which impairs the safety of **WIWA**® products and the operating personnel.

We wish you much success and excellent working results when applying your **WIWA**® Airless Paint Spraying Machine.

WIWA Wilhelm Wagner GmbH & Co. KG.

Copyright
© 2009 WIWA

Copyright ownership for this user manual remains with
WIWA WILHELM WAGNER GmbH & Co. KG
Gewerbestr. 1-3 • 35633 Lahnau
Phone: +49 (0)6441 609-0 • Fax: +49 (0)6441 609-50
E-mail: info@wiwa.de • Internet: www.wiwa.de

This operating manual is solely intended for personnel involved in preparation, operation and servicing.
It is prohibited to pass on this operating manual for reproduction, utilisation or communication of its contents, unless this has been explicitly permitted. Infringements incur an obligation to pay damage compensation. All rights reserved in the event of registration of the patented design, industrial design or registered design.

This operating manual only applies in conjunction with the machine card that was given to you with the user manual for your equipment. Please check that the type plate data is identical with the information on the machine card. Please notify us immediately if there are discrepancies, if the user manual has been incorrectly compiled or if the type plate is missing.

1.3 First read, then start

Remember that Airless Paint Spraying Equipment works under extreme pressure and that high levels of spraying pressure are created!

- Never hold your finger or hand in front of the gun and never reach into the spray.
- Never point the spray gun towards yourself, other people or other living creatures.
- Always pay close attention to the references and specifications found in the user's handbook!

Before each usage, be especially certain to:

- Check the grounding conditions (for the unit and the object to be sprayed).
- Check the seal of all connecting and mounted parts.
- Observe the maximal allowed pressure of the unit and accessory parts.

Before beginning any work on the equipment and at any pause during operation, be absolutely required to:

- Turn off the spraying equipment at the air pressure stop valve.
- Release the pressure found in the spraying gun and hose.
- Secure the spraying gun.

Pay attention to safety!

The accident prevention regulation "Handling of Coating Materials" (BGV B3) and the guidelines covering fluid sprayers ZH1/406 from the German Employer's Liability Insurance Association are to be observed without fail. To ensure a safe operating environment, the condition of fluid sprayers must be inspected by an expert every 12 months or sooner, if deemed necessary. A written record of the inspection results is to be kept.

Remaining paint and solvent are to be disposed of according to legal regulations. This also applies for environmentally friendly water lacquer or enamel systems.



In case of injuries, consult a physician or go to the next hospital without delay. If paint/material or solvent has gone into the skin, the physician has to be informed about the type of paint/material or the solvent applied. Therefore, always ensure that the product specification sheet, with address and telephone number of the manufacturer, is at your disposal!

2.1 Description of symbols

The signs and symbols used in this User's Handbook have the following meaning:

i NOTE
This marks a section of text which is especially relevant to safety. Special attention should be paid to this section and the contents strictly observed.

🚭 SMOKING PROHIBITED
This marks a situation in which a fire hazard arises through the use of flammable or explodable solid, fluid or gaseous materials.

⚠️ WARNING
This marks a situation which could be dangerous. If not observed, death or very serious injuries could result.

💣 DANGER OF EXPLOSION
This marks a situation, where there is danger of explosion. Observation of this information is absolutely essential.

⚡ ELECTRICAL VOLTAGE
This marks a situation, where there is a danger of explosion through an electrostatic charge. Observation of this information is absolutely essential.

👂 USE EAR PLUGS
For health reasons, it is very important to pay attention to this warning.

👤 USE BREATHING PROTECTION
For health reasons, it is very important to pay attention to this warning.

☠️ HEALTH DANGER
This marks materials which are hazardous to your health. Observation of this information is absolutely essential.

🏠 FIRST AID
In case of injuries or accidents, these instructions should be absolutely adhered to.

Warning signs and symbols may not be removed from the machine.

Damaged and illegible warning signs and symbols are to be replaced immediately.

The following signs are located on the machine:

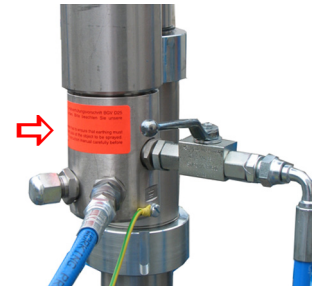

Picture 2.2.1

▶ On the high pressure filter: Warning sign covering the grounding of the machine (picture 2.2.1)

The proprietor is required according to the German Accident Prevention Regulation (Unfallverhütungsvorschrift), BGR 500, Kap. 2.29, to ensure that the machine is properly grounded. Please, observe our instruction manual.



Picture 2.2.2

▶ On the material pump cylinder: Nameplate (picture 2.2.2) Please observe that the information located on the nameplate corresponds to data found on the machine card. We request immediate notification should there be any discrepancies or if the nameplate is missing.

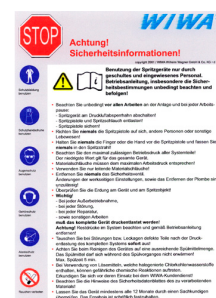

Picture 2.2.3

▶ Picture 2.2.2 Safety information This sign lists the most important safety guidelines for operating this piece of equipment. Please read this information carefully as well as adhering to all instructions located in this User's Handbook!

2.2 Warning instructions located on the machine

Warning signs and symbols which have been placed on the machine are there to inform of possible dangers and must be observed.

2.3 Dangers arising from the equipment

This machine was designed and built in accordance with all safety aspects. It corresponds with the present standards of technical regulations and current rules for accident prevention.

It left the factory in perfect condition and warrants a high level of safety. However, the following dangers exist if operated incorrectly or used inappropriately:

- to life and limb of operator or third persons
- for the machine and other property belonging to owner of machine
- for the efficient working of the machine

All personnel involved in the starting, operation and maintenance of the machine must read the following notes carefully and observe them. It is a matter of their safety! We recommend that the machine operation management have this confirmed in writing.

2.4 Application of the machine

The **WIWA**® Airless Paint Spraying Machines were especially designed for strong corrosion protection.

Modell: 24053, 24071, 28048, 28064

These airless paint spraying units are suitable for working with both low and high viscosity, high-built materials, regardless whether they are water or solvent based. Low solvent and solvent-free materials can be processed as well.

These machines are optimal for spraying applications using longer fluid hoses and larger tip-bores, as well as for spraying under high pressure conditions.

Model: 38032, 38042, 44024, 44032

These airless paint spraying machines were especially developed for the use of coarse-pigmented or abrasive materials having a low to middle level of viscosity, such as zinc primer, ferric oxide, zinc silicate on a solvent basis, glass flake, printing ink, flame protection and other heavily pigmented or fibrous materials.

These machines are known for their ability to handle a large volume of material flow, even when using large tip openings and low piston speeds and to keep unit wear at a minimum.

They are especially well suited when using automatic paint spraying systems either with or without circulation.

Using this equipment in areas requiring protection from explosions

Marking:  II 2G cT4

This equipment fulfills the explosion-proof requirements found in the guideline 94/9/EC for the type of explosion, equipment category and temperature class found on the nameplate).

This equipment is able to be installed in areas requiring Zone I explosion protection. Due to the possibility that explosive gases and overspray may be created, this unit is to

be considered as Group II, Equipment Category 2G.

The flash point for the materials being sprayed, as well as the solvent being used, must be **above** 200°C.

When operating this equipment, the User's Handbook must be followed closely.

The required inspection and maintenance intervals must be adhered to strictly.

All information found on the unit's signs or plates must be adhered to and not exceeded. Do not allow this unit to be overloaded. It is the responsibility of the operator of this equipment to determine the explosion risk (zone determination according to EC regulation 94/9/EC, Appendix II, Nr. 2.1-2.3) in the area of usage, in accordance with local regulatory authority guidelines. **Furthermore, it is the responsibility of the operator on-site to check and ensure that the technical specifications and markings according to ATEX are compliant with local requirements.**

Please observe that some components have their own nameplate with separate markings according to ATEX.

The marking with the lowest rating for explosion protection becomes valid for the entire system. If the intended application could lead to injury of personnel if this equipment malfunctions, on-site precautions and preventive measures must be implemented

If this equipment appears to be malfunctioning or behaving strangely during operation, the unit must be shut down immediately and **WIWA® Customer Service contacted as soon as possible.**



Picture 2.4.1

Spraying machines which are not protected against explosions may not be used in workplaces which fall under the regulation covering explosion protection. Pneumatically driven airless spraying machines are not affected by this. Should, however, additional electrically driven accessories be mounted to these machines, such as agitators or heaters, the regulation covering explosion prevention must be checked for compliance.

Plugs for heaters, agitators, etc. which are not protected against explosions may only be plugged into sockets located outside of areas that fall under the regulation covering explosion prevention, even if the accessory being used is explosion protected.

It must be ensured that the unit is grounded either separately or together with the equipment it is mounted to (maximum resistance 10⁶ Ω, picture 2.4.1 ground / potential equalization).

Other usage is not in line with regulations. Before **WIWA**® equipment is used for other purposes or with other materials, and, therefore, not according to the regulations, permission should be obtained from the manufacturer, as the guarantee is otherwise invalid. The observation of technical documentation and the compliance with specified operational, maintenance and starting guidelines are mandatory in accordance with the valid regulations.

2.5 Machine surroundings

Rebuilds and changes

For safety reasons, it is not allowed to carry out rebuilds or changes without authorization.

Protective equipment may not be dismantled, changed or neglected.

If using components which are not produced or delivered by **WIWA**®, warranty coverage is negated as well as liability.

The machine may only be operated within the prescribed limits and machine parameters.

Danger caused by attachments and spare parts

If you use original attachments and original spare parts from **WIWA**®, the compatibility with our equipment is guaranteed. It is, however, essential that the safety regulations of the attachments and spare parts are observed. You can find these safety regulations in the User's Handbook located with the spare parts lists.

If you use attachments and spare parts from another source, **WIWA**® cannot guarantee the safety of the entire system. In this case, our guarantee does not cover any damage or injury caused by such attachments and spare parts.

Emissions

It is possible for solvent vapours to occur, depending on the materials used. Therefore, please ensure the workplace is sufficiently ventilated in order to avoid damage to health and property. Always observe the processing information given by the material manufacturer.

The sound pressure level of the equipment is below 85 db(A).

Nevertheless, appropriate means of noise protection should be made available to the operating staff.

The operator is responsible for compliance with the rules covering the prevention of accidents due to „noise“ (BGV B3). Therefore, pay special attention to the environmental conditions at the site, e. g. noise can be increased if the machine is installed in or on hollow bodies.

Exact details regarding noise emission are mentioned in the Chapter "Technical specification".

2.6 Sources of danger

Remember that **WIWA**® Airless Paint Spraying Machine work under extreme pressure procedures and that they can cause life-endangering injuries if used inappropriately.



Warning!

Material exits the spray gun at very high pressure levels. The spray jet can cut or be injected under the skin or eyes, resulting in serious injuries.

- **Never** point the spray gun towards yourself, other people or other living creatures.
- **Never** hold your finger or hand in front of the spray gun and **never** reach into the spray jet.



Warning!

Unintentional triggering of the spray gun can lead to injury or damage to property.

- Always apply the spray gun safety catch, regardless how short the pause in spraying is.
- Before operation, always check the function of the spray gun safety catch.



Warning!

Components that do not correspond to the maximum pressure created by the pump are quickly prone to rupture, leading to serious injuries.

- Fluid hoses **must** be rated to correspond to the maximum operating pressure of the unit, with an appropriate safety factor allowance.
- No hoses may show signs of leaks, kinks, wear or blisters.
- All hose connections must be tight.



The maximum operating pressure stated by us must correspond to all **WIWA**® components and accessory items within the system (i.e. pumps, heaters, hoses, spray guns, safety valves).

If the pressure ratings differ, the lowest rated max. pressure becomes valid for the entire system.

Example:

Pump	max. 420 bar (6090 psi)
Fluid hose	max. 600 bar (8700 psi)
Spray gun	max. 500 bar (7250 psi)

The maximum allowable operation pressure for the entire system is 420 bar (6090 psi).



Warning!

If used outdoors, a lightning strike could lead to injury.

- **Never** operate the unit outdoors during a thunderstorm.



Warning!

It is possible for a static charge to occur due to the high flow speeds during the airless spraying procedure. Static

charges can lead to fire and explosions.

Always use an open container.

- **Never** spray solvents or materials containing solvents into narrow-necked cans or barrels with bung holes!
- Ensure that the spray gun has contact with the container walls when working with metal containers.



Danger of explosion!

Heated solvent can lead to an explosion within the pump. This could result in serious injuries, including loss of vision, and property damage. Always observe the flashpoint and ignition temperature for the solvent being used!

Turn off the fluid heater whenever the following work is performed on the pump:

- Flushing / Cleaning
- Pressure check
- Preparation for operation
- Shutting down

Dangerous chemical reactions can occur if closed or pressurized systems with aluminum or galvanized pump components come into contact with solvents such as 1.1.1 - trichlorethylene or methylene chloride that contain halogenated chlorofluorocarbons (CFC). If such solvents, or paints or lacquers that contain them, are to be used, we recommend contacting **WIWA**® Customer Service or the **WIWA**® factory directly for further information.

Please note that there are stainless-steel Airless pumps that are designed for use with such materials.



Danger!

If being operated in closed rooms, explosive atmospheres can be created. This could lead to serious injuries and property damage. Smoking, using open fires or other ignitable sources is prohibited in the entire area of operation!

2.7 Operating staff

Authorised Operators

People under the age of 16 should not operate this equipment.

The management in charge of the operation of the machine must make the User's Handbook available to the operator and must make sure that he has read and understood it. Only then may the system be put into operation.

We recommend the manager has this confirmed in writing. The operator of the machine is obliged to report any changes in the machine which might affect its safety to the manager, as he must ensure that the machine is

functional. The responsibilities for the different activities on the system must be laid down clearly and adhered to. No unclear competences may remain as these could endanger the safety of the users.

The operator must make sure that only authorised persons work on the machine. He is responsible to third parties in the working vicinity of the system.

The operator of the equipment is obliged to repeat instructions about dangers and safety measures at regular intervals (at least once a year, for young persons twice a year).

Personal protective equipment

- We call to your attention that the valid guidelines and requirements in accordance with work surroundings (mining, closed areas etc.) must be absolutely adhered to. The prescribed protective clothing must be worn at all times, as solvent vapours and solvent splashes cannot be completely avoided



- The sound pressure level of the equipment is below 85 db(A).

Nevertheless, appropriate noise protection means should be made available to the operating staff.



- Although spraying fog is kept to a minimum when the correct pressure setting and proper method of operation are observed, the operating painter should wear a protective breathing mask.



- When working with heated materials, the outer surface of the pump can become hot.

Protective gloves must be worn at all times.



- Never use solvent or other materials which present a health hazard for cleaning skin. Only suitable skin protective, skin cleansing and skin care materials may be used.

2.8 Installation site

- The system must have a fixed position and sufficient space to ensure safe operating. The passage to the safety fittings must not be blocked.
- Keep the working area, especially all gangways and standing areas, clean. Remove spilled paint or solvent immediately.
- Ensure there is sufficient ventilation at the workplace to prevent damage to health and property. Observe the manufacturer's processing instructions at all times.

- Despite the fact that no legal regulations exist covering the low-fog airless spraying method, dangerous solvent fumes and particles of paint should be removed of per vacuum.
- The owner / operator of this equipment is required to ensure that proper protection against lightning strikes is available.
- Comply strictly with the current rules for accident prevention.

2.9 Behavior in case of emergency



Leaks

If leaks occur in hoses or hose connections, material is expelled under very high pressure. This can result in very serious injuries to hands, arms or eyes.

- Never try to seal leaks with hands or by bining
- Never patch fluid hoses.
- Should a leak occur, the whole system is to be shut down and depressurized immediately:
 - Close the air tap lock to cut off the inbound air supply.
 - Hold the drain hose into an appropriate container and ensure that it can not slip.
 - Open the drain valve.
 - Replace the defective parts immediately or contact **WIWA®** Customer Service.



Injuries

- Should an injury occur (i.e. spray jet cut or injection), we recommend a doctor be called immediately.
- Inform the doctor of the material sprayed (e.g. paint) and the solvent (thinner). Have the product data sheet at hand (adress and telephone number of supplier or manufacturer, name of material and material number).
- Memorize where aid can be found.
- Memorize the local emergency phone numbers.
- Become familier with the first-aid measures

Fires

- Read and and observe the instructions for fire alarm and escape routes put up in your factory.
- Do not use any other extinguishing agents than those which are prescribed by the coatings manufacturer.

2.10 Safety features

This equipment is delivered with the following safety features:



Picture 2.10.1

Safety valve

(Picture 2.10.1)

The safety valve prohibits the maximum allowable inbound air pressure from being exceeded. If the inbound air pressure exceeds the maximum allowable value, the safety valve will blow off.



Warning!

The safety valve is factory mounted and sealed to the air motor. To ensure safe operation:

- Never remove the safety valve.
- Never change the safety valve setting.

New safety valves must correspond to the maximum allowable inbound air pressure and be sealed appropriately. The part number and maximum allowable inbound air pressure can be found in the machine card for the unit.

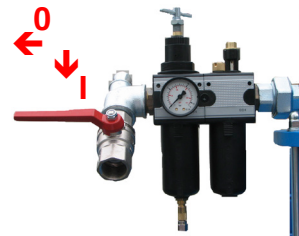

Picture 2.10.2

Air tap lock

(Picture 2.10.2)

The compressed air tap lock makes it possible to shut Air tap lock. The compressed air tap lock makes it possible to shut down the unit immediately.



Picture 2.10.3

Ground cable connection

(Picture 2.10.3)

Due to the high flow speed created by Airless equipment, static charging can occur. A static charge can lead to fires or explosion.

The unit must, therefore, always be grounded properly. Factory-delivered **WIWA**® Airless spraying equipment comes standard with a ground cable. If lost or defective, it must be replaced (part no. 0474487)..

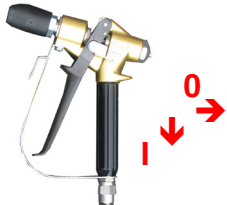

Picture 2.10.4

Spray gun safety catch (Picture 2.10.4)

The spray gun safety catch is used to avoid unintentional triggering of the spray gun. Apply the safety catch ("on") at any pause in spraying!

All safety devices must be checked:

- Before commissioning the system!
- Before beginning to work with the system!
- After any modifications have been made to the unit!
- After flushing or cleaning the system!
- After any repair or maintenance work on the system!

Checklist for checking the safety devices with the system depressurized

- Check to see whether the seal on the safety valve is damaged.
- Check the safety valve for signs of damage.
- Check the ground cable for damage.
- Check the connections for the ground cable on the unit and the conductive object it is connected to.
- Check whether the air tap lock is functioning properly.
- Check the spray gun safety catch to ensure it functions properly.



If one of the safety devices is not functioning properly or if any other malfunction is found, the air supply to the unit must be cut off and the drain valve opened.

The unit may only be restarted once the problem has been solved and the system is functioning perfectly again.

2.11 Pump handling and auxiliary materials

Adjusting, servicing, cleaning, maintenance and repair of the unit

- Before starting any of the above:
 - Turn off the unit
 - Depressurize the system. Pay attention to residual pressure.

Activity	Personnel Qualification
Adjusting work	trained operator

Activity	Personnel Qualification
Servicing work	trained operator
Cleaning work	trained operator
Maintenance work	personnel trained by WIWA ® Customer service
Repair work	personnel trained by WIWA ® Customer service

- After work is completed
 - Check the proper function of all safety features.
 - Check the proper function of the entire unit.

Handling of auxiliary materials

- When handling auxiliary materials such as paint, solvent, oil, grease and other chemical substances, comply with the safety and dosing instructions of the manufacturer and the generally applicable regulations.
- Leftover solvents, oils, grease and other chemical substances must be collected according to the legal regulations for recycling and waste disposal.
- The local official laws for the protection of waste water must be observed.

2.12 Transporting

- Disconnect the unit from the main air supply and from any electrical outlets for accessory items, even if the unit is only to be moved a short distance.
- Empty the unit before transporting.
- Be careful when using a hoist to load this equipment!
- If using a hoist, ensure that the weight capacity is not exceeded and that proper lifting attachments are employed.
- Attach the hoist securely to the unit.
- Never stand under or near the unit when it is suspended. Serious injury could result!
- Only use appropriate hoisting equipment with sufficient load capacity.
- Secure the unit to the transporting vehicle in such a way that it can not slide or fall off.
- When lifting or loading the unit, do not transport any further items (i.e. paint cans or pails) along with it.
- Any components or accessories that had to be removed for transport must be remounted by skilled and trained personnel before beginning operation



Picture 2.12.1

Two ring screws are located on the machine's air motor (picture 2.12.1) to ensure safe lifting with hoisting devices.

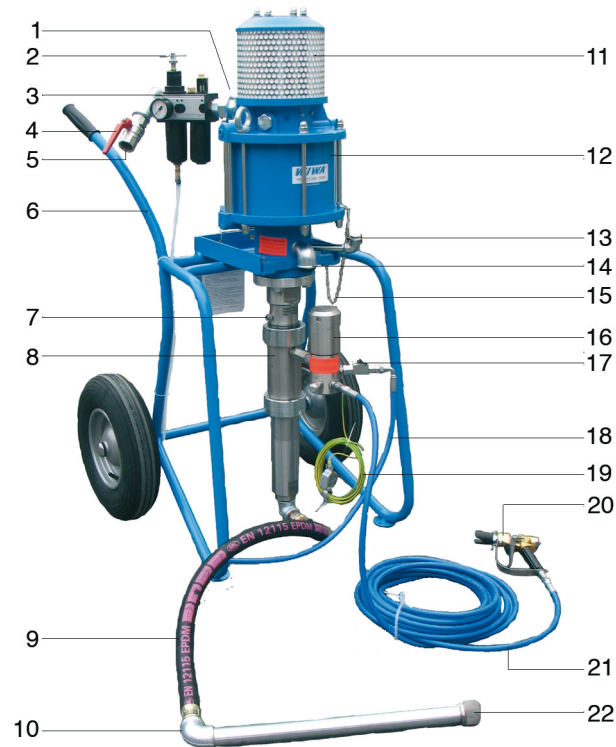

Positions

- | | | | |
|----|-----------------------------|----|-----------------------------|
| 1 | safety valve | 12 | air motor |
| 2 | t-handle screw | 13 | Release agent - filler neck |
| 3 | maintenance unit | 14 | vent hole |
| 4 | air tap | 15 | spanner with chain |
| 5 | air inlet | 16 | high pressure filter |
| 6 | cart | 17 | high pressure valve |
| 7 | Release agent - drain screw | 18 | dump hose |
| 8 | material pump | 19 | Ground cable |
| 9 | suction pipe | 20 | spray gun |
| 10 | suction hose | 21 | material hose |
| 11 | air muffler | 22 | fluid seive |

Job

The unit is to be installed at the job site and prepared for operation.

Prerequisite

- The material to be worked with is prepared.
- All materials to be sprayed should be marked with information on viscosity, processing temperatures, mixing proportions etc. If this is not the case, please acquire this data from the relevant manufacturer.
- The material to be sprayed must be slowly but thoroughly stirred before beginning to work.

i **WIWA®** offers a broad selection of accessories for the optimised preparation of spraying materials, i.e.:

- agitators in various sizes
- material pre-heating containers in various sizes
- fluid heater

If working with plural component materials, the pot life must be observed.

- To insure that the necessary volume of air is supplied, the compressor capacity must comply with the air consumption requirements of the pump. The diameter of the air supply hoses must correspond to the connection on the pump.

Procedure**1. Set up the pump**

i High pressure spraying machines and systems can be integrated into spraying chambers either inside or outside of production facilities. To avoid possible soiling, an outside installation is preferable. Dimensions and weights of the equipment are indicated in Chapter "Technical specification".

- The pump must be set up securely on a level and solid surface
- Pay attention to the information covering the required floor space found in machine card.
 - Operating elements must be easily accessible
 - Safety features must be easily accessible

Wall-mounted versions:

- To fix the wall-mount, use M 12 screws - class 8.8
- Be sure to use anchoring devices in accordance with the nature of the wall being used.
- Ensure that at least 10 cm (4 in.) free space is left between the suction elbow and the floor after mounting.

2. Mount accessories

Different components of the machine were dismantled and packed in a separate carton for shipping:

1. material hose (picture 4.1.1)
 2. airless spraying gun (picture 4.1.2)
 3. maintenance unit, (picture 4.1.3) as well as
- If the machine is delivered on a trolley, the maintenance unit and compressed air regulator remain mounted..

- Add these components as pictured (pictures 4.1.1 to 4.1.3).

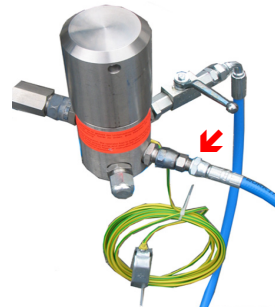

Picture 4.1.1

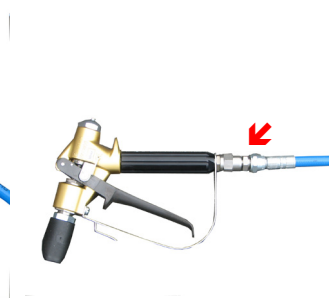

Picture 4.1.2

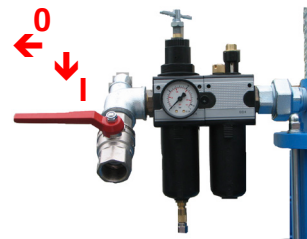

Picture 4.1.3

**Warning!**

Material leaks at connections can lead to serious injury or property damage.

Check all turnable parts, nuts, screws and hose connections and tighten them securely.

- Check the permissible maximum air pressure for the spray hose, spray gun and accessories. It must be greater than or equal to the maximum operational pressure shown on the pump's nameplate or on the machine card.
- Compare the maximum operating pressure of the safety valve with the information on the machine card or the type plate. This information must correspond.

3. Ground the unit



Warning!

Due to the high flow speed created by Airless equipment, static charging can occur. A static charge can lead to fires or explosion

A static charge can lead to fires or explosion.

- The pump and object to be coated must be grounded properly
- Only use conductive hoses

Note: **WIWA**® spray hoses are conductive and compatible with **WIWA**® pumps.

4. Open the anti-vacuum hole



- When being used for the first time, the sticker with the text „remove before use“ and the sealing plug is to be removed from the ventilation hole (overflow). The ventilation hole is located in the elbow with the opening facing downward (picture 4.2.1).

Picture 4.1.4

5. Check the release agent level

- Check the level of release agent - refer to Chapter 8.2 "Maintenance plan".
The unit is filled with release agent prior to delivery.

6. Maintenance unit prepare

- Fill the maintenance unit with pneumatic oil or anti-freeze and take the setting as described in chapter 8.4 "Maintenance on the maintenance unit."

Result

The machine is now ready for operation. Continue with the first cleaning (chapter 5.1).

5.1 First cleaning

Job

This machine was factory tested after assembly for perfect functioning with a test-medium. The entire system should be flushed with wash thinner before spray operation begins so that the material to be sprayed is not affected by the test-medium.

Prerequisite

➤ Required:



1 open container with cleaning material (at least 5 liters / 1.3 gal. of wash thinner or solvent), called container "A" below.

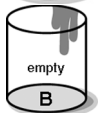

1 empty, open container for the mixture of cleaning material and test-medium, called container "B" below.

- Please, check whether the material hoses comply with the maximum working pressure and the prescribed safety factor. They should not have any leaks, kinks, signs of wear or bulges. The hose fittings must be securely attached and also comply with maximum pressure.
- When using a fluid heater, please, be sure to observe that it is cold during the cleaning process.



Please wear protective clothing at all times, as solvent vapours and splashes of solvent cannot be avoided completely.

Procedure

1. Prepare the spray gun for operation

- Close and apply the safety catch.
- Remove the tip from the spray gun. Observe and follow the instructions found in the spray gun's User's Handbook.
- Attach the material hose to the secured airless spray gun.
- Connect the material hose with attached gun (without the nozzle) to the outlet of the high pressure filter.

2. Prepare the solvent container

- Place the suction pipe with strainer into the "A" container.

3. Connect the compressed air line (Picture 5.1.1)

- Close the air tap lock.
- Turn the control knob on the air pressure regulator counter-clockwise until it turns freely.
- Connect the air supply line to the inbound air connection.

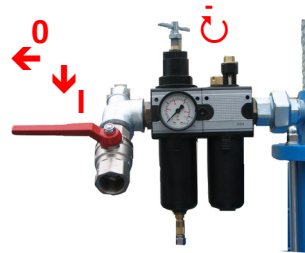

Picture 5.1.1

4. Remove the filter insert

- Remove the filter insert from the high pressure filter in accordance with chapter 8.3.
- Hold the drain hose (Picture 5.1.2, Pos. 2) into container "B" and secure it against slipping.
- Open the relief tap on the high pressure filter (Picture 5.1.2, Pos. 1).
- Open the main air supply tap. (Picture 5.1.1). Adjust the air regulator to a maximum of 2 bar (30 psi) by slowly turning the regulating screw to the right.
- Allow the Wash Thinner, soiled with the test-medium, to run out of the relief hose into the open container „B“ for at least 10 seconds.
- Close the relief tap (Picture 5.1.2, Pos. 1).

Recommended cleaning time:

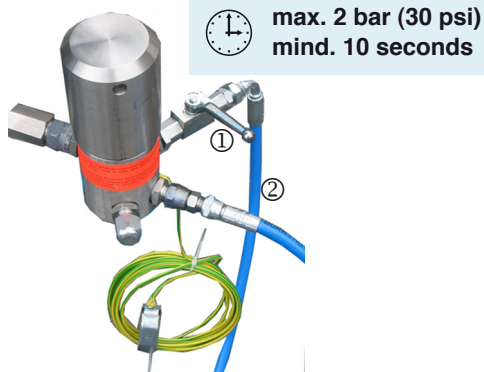

Picture 5.1.2

5. Clean the spray gun



- Hold the spray gun into container "B".
- Spray for a minimum of 10 seconds against the inner wall of the container. Ensure that the spray gun has contact with the container walls when working with metal containers.



We recommend a cleaning period of approx. one minute for a good cleaning result. In order to avoid the danger of explosion caused by the heating of cleaning material, it should not be pumped for longer periods (a maximum of 5 minutes) of time.

5. Open the de-icing system on air motor

- Activate the de-icing system by slowly turning the control screw to the right (available option).
- We recommend: minimum 1 complete turn
 maximum 3 complete turns



Adjust the de-icing system according to your individual requirements, as factors such as pressure, number of cycles per minute, humidity and ambient temperature can affect the amount of air that is required to avoid ice build-up.

Result

The machine is now completely cleansed. Continue with the pressure check (found in chapter 5.2)

5.2 Checking pressure

Job

You want to inspect the seal all system components.



If using a fluid heater, the heater may not be turned on at any time while making the pressure test. The entire machine must be cooled completely. DANGER OF EXPLOSION! Observe the flash point for the solvent being used!

Procedure

1. Close the spray gun

- Close the spray gun and apply the safety catch.

2. Set the maximum pressure

- Set the maximum allowable pressure by turning the air pressure regulator control knob clockwise (Picture 5.1.1).



Observe the maximum allowable operating pressure for all system components. If the ratings vary, the lowest pressure rating becomes the maximum allowable pressure for the entire system (refer to the example in Chapter 2.6).

3. Check the safety valve

- Briefly raise the pressure approximately 10% above the maximum allowable inbound air pressure. The safety valve must blow off

4. Check the seal of the system components

- Check the seal of the following components:
 - Spray hose
 - Spray gun
 - High-pressure filter
 - Connections

5. Pump out the remaining solvent in the system

- Turn the air pressure regulator control knob counterclockwise until the pump only runs very slowly.
- Remove the suction pipe from the container "A".
- Hold the spray gun into container "B".
- Disengage the safety catch and open the spray gun.
- Pump any remaining solvent out of the system.
- Turn the air pressure regulator control knob counterclockwise until it turns freely.
- Close the air tap lock.
- Close the spray gun and apply the safety catch.
- Hold the drain hose into container "B" and secure it against slipping.
- Depressurize the pump by briefly opening the drain valve / drain screw on the high-pressure filter.

Result

The unit is now ready for operation..

6.1 Equipment preparation

Job

Prepare the unit for operation.

Prerequisite

➤ Required:



1 open container with cleaning material (solvent belonging to the coating material and recommended by the material manufacturer), called container "A" below

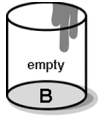

1 empty, open container for the soiled cleaning material/material mixture, abbreviated as container "B" below.



1 material container, called container "C" below.

- Inspect the seal of all system components and tighten the connections, if necessary.



Please wear protective clothing at all times, as solvent vapours and splashes of solvent cannot be avoided completely.



Do not use narrow-necked cans or barrels with bung holes

Procedure

1. Connect the inbound compressed air line (Picture 6.1.1)

- Close the air tap lock.
- Turn the air pressure regulator control knob counterclockwise until it turns freely.
- Connect the inbound air line to the fitting on the air motor.

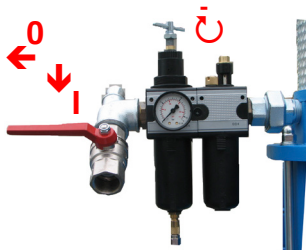

Picture 6.1.1

2. Pressure check

- Complete the pressure check described in Chapter 5.2.

3. Place a filter element into the high-pressure filter

- Depressurize the system.
- Place a filter element according to Chapter 8.3 into the high-pressure filter.

4. Feed preparation / Bleeding air from the unit

- Place the suction pipe into container "C".
- Hold the drain hose into container "B" and secure it against slipping.
- Open the drain valve on the high-pressure filter.
- Open the air tap lock.
- Turn the air pressure regulator control knob clockwise until the pump slowly cycles.
- As soon as coatings material comes out of the drain hose, close the drain valve / drain screw tightly.
- Disengage the safety catch and trigger the spray gun.
- Spray the remaining solvent in the unit into container "B" until only coatings material exits the gun.
- Close the gun and apply the safety catch.
- Clean the gun outlet with solvent and a brush.
- Mount a spraying tip or a reversible guard with the appropriate tip.



Observe and follow the instructions found in the User's Handbook for the spray gun being used.



RISK OF EXPLOSION!

When using a fluid heater, the following steps must be strictly adhered to:

- **Before allowing the fluid heaters to heat, the materials to be sprayed must be circulated in a cold condition as there may be solvent residue in the fluid heaters or somewhere else in the systems.**
 - **Be certain to ensure that the fluid heaters are turned off during preparation.**
 - **Always observe the flash point of the solvent being used as stated in the manufacturer's data sheet!**
- Set the required operating pressure by adjusting the air pressure regulator control knob accordingly.

Result

The unit is now ready for coatings operation. Begin spraying according to Chapter 6.2.

6.2 Spray operation

- Disengage the safety catch and begin spraying.



Explosion Danger

If the feed of material is interrupted during operation, the unit can run dry. The resulting friction can lead to an explosion that results in injuries and/or property damage. Therefore:

- Do not allow the pump to cycle if the feed container is empty.
- Do not allow the suction assembly to become plugged, kinked or otherwise defect.
- If no coatings material exits the gun, shut the unit down immediately.

Set the operating pressure

- The optimal operating pressure is reached when coating applies evenly with graduated edges. Only use as much pressure as is necessary to achieve a good spray pattern at a distance of approx. 30-40 cm (12-16 in.) to the object being coated.



If the pressure is too high, excessive material consumption and spray fog will result. If the pressure is too low, fingering and uneven coating thicknesses will result.

Coating / Finishing tips

- Hold the spray gun at a 90° angle to the surface being coated. If held at a different angle, the coverage will be uneven and spotted (Picture 6.2.1).
- The sprayer's arm must move evenly back and forth.
- An even speed must be maintained.
- Move the spray gun parallel to the surface being coated.
- Move the spray gun with the arm and not with the wrist. Waving the spray gun will lead to uneven coating results (Picture 6.2.2).
- Begin moving the spray gun before the trigger is pulled. This ensures even, smooth overlapping results and avoids higher coating builds when the trigger is first pulled.
- Release the trigger before ceasing arm movement.

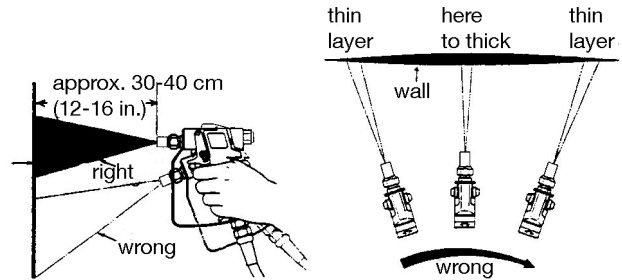

Picture 6.2.1

Picture 6.2.2

Pauses in work



Picture 6.2.3

- Apply the spray gun safety catch at any pause in work. (Picture 6.2.3) Immerse the tip in a container of appropriate solvent.
- This will avoid residue coatings material from hardening and blocking the tip opening.

Exchanging the spray tip

- Exchange the spray tip before it is worn. Worn tips result in increased paint consumption and reduced spray coating quality.

6.3 Change of material

1. Shut down the unit

- Complete all steps for shutting down the pump found in Chapter 7.

2. Clean or replace the filter insert

- Clean the filter insert or replace it if it is damaged.
- Place the cleaned or replacement filter insert into the high-pressure filter according to Chapter 8.3.

3. Clean the suction strainer

- Clean the suction strainer using the solvent recommended by the manufacturer of the coating, or replace it if necessary.

4. Operation

- Complete all the steps found in Chapters 6.1 + 6.2 Operation.

Job

The unit is to be cleaned and taken out of service after work is completed.

Prerequisite

➤ Required:



1 open container with at least 5 liters (1.3 gal.) of cleaning material (the solvent must correspond to the coating material and be recommended by the material manufacturer), called container "A" below.

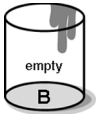

1 empty, open container for the solvent/coating material mixture, called container "B" below.

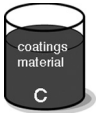

1 material container, called container "C" below



Please wear protective clothing at all times, as solvent vapours and splashes of solvent cannot be avoided completely.



Do not use narrow-necked cans or barrels with bung holes

Procedure**1. Turn off and depressurize the unit**

- Close the air tap lock.
- Turn the air regulator control knob counterclockwise as far as possible. The pressure gauge must read 0 bar (psi).
- Close the spray gun and apply the safety catch.
- Hold the drain hose into container "B" and secure it against slipping.
- Briefly open the drain valve on the high-pressure filter to depressurize.

2. Tip dismount and clean

- Dismount the standard tip and clean it thoroughly.



We recommend storing the tip (standard or reversible) in the solvent recommended by the coatings manufacturer. This will avoid residual paint from drying and clogging the tip.

3. Clean the high-pressure pump

- Remove the suction pipe from container "C".
- Wipe residual paint on the suction pipe and strainer into the container.
- Place the suction pipe with strainer into container "A".
- Open the air tap lock.
- Slowly turn the air regulator control knob clockwise until 1-2 bar (15-30 psi) operating pressure is reached.

- Hold the drain hose into container "B" and secure it against slipping.
- Open the drain valve on the high-pressure filter until clean solvent exits the hose.



- Close the valve tightly
Hold the spray gun against the inner wall of container "B".
- Trigger the gun until clean solvent is emitted. Be sure to maintain contact with the inner wall of the container.
- Close the spray gun and apply the safety catch.
- Lift the unit out of container "A".
- Again, hold the drain hose into container "B" and secure it against slipping.
- Open the drain valve on the high-pressure filter until the pump runs dry.
- Turn the control knob counterclockwise until it turns freely. The pressure must read 0 bar/psi on the pressure gauge.



To avoid unnecessary loss of material still in the hose, we recommend spraying the coating back into container "C" until solvent emerges from the gun.

If working with plural component materials, the pot life must be observed. All system components that come into contact with the mixed material must be cleaned with the appropriate solvent within the pot life given by the coatings manufacturer.

Observe:

- Warm temperatures reduce the pot life.
- Allow the solvent to circulate for a while.
- No paint residue may remain in the pump or high-pressure filter.

4. Removing the filter insert

- Remove the element from the high-pressure filter according to the instructions found in Chapter 7.3.
- Wipe the inside of the high-pressure filter completely clean.
- Close the high-pressure filter with only the nut mounted inside (without the filter element!).

If taken out of service for a long period

- Clean the unit as described.
- Do not, however, completely empty the pump of solvent.
- As soon as clean solvent exits the spray gun and high-pressure filter, reduce the pressure to 0 bar/psi.
- Hold the spray gun against the inner wall of container "B" and trigger briefly.
- To depressurize the high-pressure filter:
 - Hold the drain hose securely into container "B"
 - Briefly open the drain valve
- The solvent that is left in the material pump is to remain until the next time the pump is used.
- When restarting the pump, be sure to flush the system thoroughly.

8.1 Regular inspections

According to the rules for the prevention of accidents „Working with liquid jet systems“ BGR 500, Kap. 2.36 the equipment must be checked and overhauled at regular intervals by a specialist (WIWA® Service).

The equipment must be checked:

- before the first start-up,
- after changes and repairs of equipment parts having an effect on safety,
- after an interruption of operation of more than 6 months,
- however at least every 12 months.

For equipment, which has been taken out of operation, the check can be postponed up to the next start-up. The results of the checks must be recorded in writing and kept until the next check. The checking certificate or a copy of it must be available at the place where the equipment is used.

8.2 Maintenance plan



Warning!
Dismantling the pump under pressure can lead to serious body and/or eye injury.

- Before performing any maintenance or repairs, the pump must be turned off.
- Depressurize the entire system.
- Disassemble the high-pressure filter, fluid hoses and spray gun very carefully.
- Cover the hose connections with a rag before dismantling to avoid paint splashes.

Check the release agent amount

- Before every start-up check the amount of release agent in the release agent chamber. (Picture 8.2.1) If necessary, fill release agent into the filling tube until the release agent is visible approx. 1 cm (0.4 in.) below the opening. The chamber holds approx. 50 ml (1.7 fl.oz.) of release agent.
- Check regularly the release agent for discoloration caused by contact with the spray material. The discoloration can be monitored by draining a small amount of release agent. After checking, add a corresponding amount of clean release agent to the chamber.

Heavy discoloration and material contermination:



These steps may only be performed by personnel trained by WIWA® or WIWA® Customer Service.

- Replace the material pump packing sets (refer to the spare parts list for the material pump)
- Clean the release agent chamber.
- Fill the chamber with clean release agent.

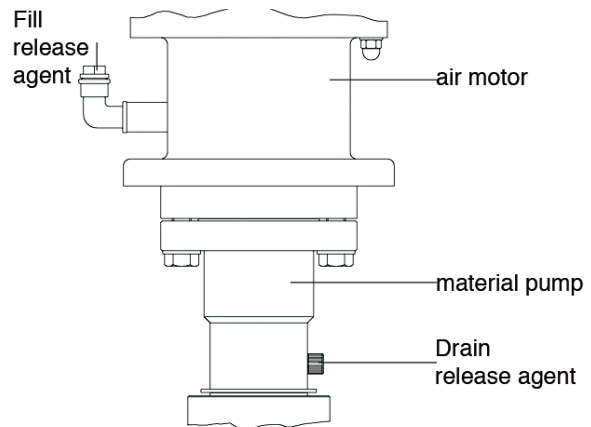

Picture 8.2.1

High-pressure filter maintenance

Clean the filter insert before every change of spray material or daily, at the latest.

Observe and follow the instructions found in Chapter 6.3 "Change of material".

8.3 High pressure filter

Job

- Clean or replace the filter insert:
 1. after shutting down the unit (daily).
 2. before every change of spray material.
 3. if the pump does not cycle although the spray gun is triggered (without tip) or the drain valve / drain screw for the high-pressure filter is opened.

Prerequisite

- Required are:

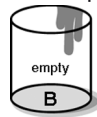

An empty, open container for the mixture of solvent / spray material, hereafter called container "B".

- 1 open-end wrench Size 13



Warning!
If blockages occur, residual pressure may still be in the system even after depressurizing. Residual pressure can lead to serious injuries to the body or eyes.

- Before starting any work on the high-pressure filter, the pump must be turned off.

- Briefly trigger the spray gun.
- To drain pressure, open the drain valve / screw on the high-pressure filter.
- Disassemble the high-pressure filter very carefully!
- Replace worn parts with new ones..

Procedure

- Hold the drain hose into container "B".
- Close the air tap lock for the pump.
- To depressurize, open the drain valve (Picture 8.3.1, pos. 6).

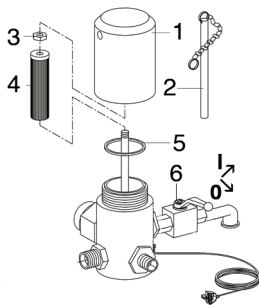

Picture 8.3.1

Removing the filter insert

- Unscrew the cap (Picture 8.3.1, pos. 1) with the spanner (Picture 8.3.1, pos. 2).
- Unscrew the nut (Picture 8.3.1, pos. 3) with a fork wrench and remove the filter insert (Picture 8.3.1, pos. 4)).
- Clean the filter insert.
Use only the appropriate solvent for the material being worked with.
Replace the filter insert should any sign of damage be present..
- Replace the o-ring (Picture 8.3.1, pos. 5) should any sign of leakage be present

Mounting the filter insert

- Mount the high pressure filter in reserve order.

Instructions



Before restarting the pump ensure that the unit is properly grounded.



R (corrosion resistant) + **RS** (stainless) versions:
Lightly grease all threads to ease assembly / disassembly.

Filter insert selection

The insert must:

- correspond to the material being sprayed
- be compatible with the spray tip used
The mesh should always be a little finer than the bore of the tip being used:

Filter insert	Tip size (mm/")	
	from	to
M 200 (white)	-	0,23/.009
M 150 (red)	0,23/.009	0,33/.013
M 100 (black)	0,33/.013	0,38/.015
M 70 (yellow)	0,38/.015	0,66/.026
M 50 (orange)	0,66/.026	-



If working with heavily pigmented or fiber-filled materials:

- do not use a filter insert.
- the standard suction sieve may need to be replaced with a sieve having a larger mesh size.
- use a **WIWA**® reversible tip

8.4 Maintenance unit

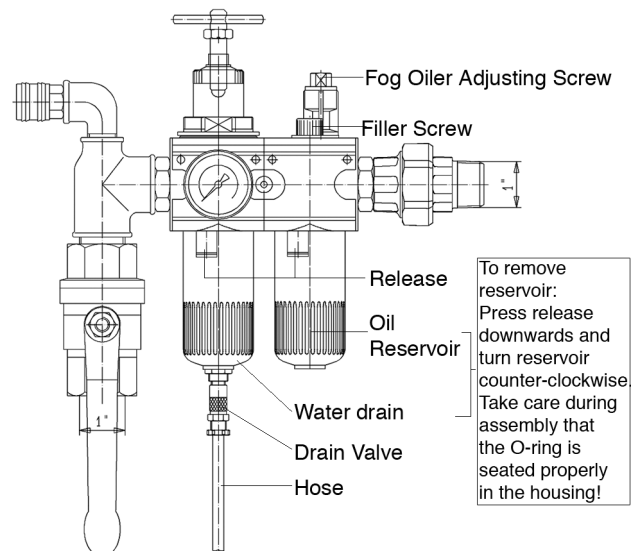

Picture 8.4.1

Lubricant and/or anti-freezing agent

- Check the air motor's lubricant in the bowl of the air maintenance unit and refill, if required.
- High air humidity can cause icing of the motor.
- In case of icing, only use pure anti-freezing agent.

Adjustment of the fog oiler on the air maintenance unit

- Let the air motor run slowly at an air inlet pressure of approx.4 bar.
- Check the sight glass on the fog oiler to ensure that one drop of lubricant is fed into the compressed air at every 10 - 15 double strokes of the air motor. If this not the case, the adjusting screw on the fog oiler has to be set accordingly.
- Check the oil level in the reservoir daily.



The air maintenance unit may not be operated without oil. The maximum oil level is marked with a line around the reservoir.

- To fill the reservoir, remove the filler screw or remove the reservoir and fill directly.
- Only use the lubricants and anti-freezing agent as indicated in Chapter "Appendix/ Auxiliary materials".

Condensed water drain

- The collected condensation will be automatically drained by the drain valve. Place the hose into an empty catch basin.
- Check the reservoirs regularly for contamination and clean as necessary.

Notes to the oil reservoir/water cutoff

- To remove reservoir:
 - Press release downwards.
 - Turn reservoir counter-clockwise.
- Montage:
 - Take care during assembly that the O-ring is seated properly in the housing!

Fault	Possible Cause	Solution
The pump does not cycle whether the spray gun is triggered (without tip) or the drain valve / screw is opened.	➤ Air tap lock is closed.	➤ Open the air tap lock.
	➤ High-pressure filter is clogged.	➤ Clean or replace the filter insert.
	➤ Air motor is defect.	➤ Repair the air motor according to the spare parts list - Contact Customer Service if necessary.
Pump cycles, but no material reaches the tip.	➤ Suction sieve is clogged.	➤ Clean the sieve.
	➤ Suction hose is blocked.	➤ Replace the hose.
	➤ Bottom valve ball does not rise (stuck).	➤ Trigger the spray gun without tip. <ul style="list-style-type: none"> ➤ Open the high-pressure filter drain valve/screw ➤ Lightly hit the bottom valve from the side (hammer). ➤ Remove the suction assembly and press on the ball from below using a peg or screwdriver until loose.
	➤ Bottom valve does not close.	➤ Remove the bottom valve and clean the ball and seat thoroughly.
Pump cycles but does not stop with the spray gun is closed.	➤ Packing and/or valve worn.	➤ Replace.
Pump cycles evenly but the required operating pressure can not be reached	➤ Air supply / pressure is too low.	➤ Increase the inbound air pressure with the regulator and check the diameter of the inbound air hose.
	➤ Tip (new) is too big.	➤ Use a smaller tip or larger pump.
	➤ Tip is worn (too big).	➤ Replace.
	➤ Air motor is frozen (runs too slow).	➤ If possible, reduce the inbound air pressure. <ul style="list-style-type: none"> ➤ If not already in use, mount an air maintenance unit with oiler. Fill the oiler with anti-freeze (Glysantine) and set it according to the instructions in the User's Handbook: Average setting: 1 drop every 10 cycles
Pump cycles unevenly (different stroke speeds on the upward and downward strokes) and the required spray pressure can not be reached..	➤ The viscosity of the coating is too high (suction loss).	➤ Thin the coating. <ul style="list-style-type: none"> ➤ Use a larger pump.
	➤ Suction assembly leakage (spray jet fluctuates).	➤ Check the seal of all suction assembly connections and replace if necessary.
	➤ Bottom valve leaks (pump only stops on the upwards stroke when the spray gun is closed).	➤ Remove the bottom valve and clean the ball and seat thoroughly.
	➤ Piston valve leaks (pump only stops on the downwards stroke when the spray gun is closed).	➤ Clean the ball and seat in the dual piston and replace if necessary.
	➤ Upper or lower packings leak (wear).	➤ Replace.
	➤ Packings are worn.	➤ Replace. <p>Note: Do not close or block the anti-vacuum hole!</p>
Coatings material spills out of the air motor anti-vacuum hole.	➤ Packings are worn.	➤ Replace. Note: Do not close or block the anti-vacuum hole!

10.1 Technical specifications

Model	24026	24053	24071	28023	28048	28064	38032	38042	44024	44032
Air motor piston diameter (mm)	140	200	230	140	200	230	200	230	200	230
Air motor piston stroke (mm)	120	120	120	120	120	120	120	120	120	120
Pump ratio	26:1	53 : 1	71 : 1	23:1	48 : 1	64 : 1	32 : 1	42 : 1	24 : 1	32 : 1
Max. free-flow output (ltr/min)	24	24	24	28	28	28	38	38	44	44
Output per cycle (cm ³)	138	138	138	153	153	153	235	235	306	306
Max. input air pressure (bar)	8	8	6,5	8	8	7	8	8	8	8
Max. operating pressure ((bar)	208	420	460	184	380	450	255	335	190	255
Max. tip size (high pressure filter) (inch)	1/4 NPSM (A) 2 x 3/8									
Air inlet (maintenance unit) (inch)	1									
Dimensions LxWxH										
cart mounted (cm)	65 x 70 x 130									
wall mounted (cm)	60 x 45 x 130									
Net weight (cart mounted) (kg)		85	86		85	86	90	91	91	92
Sound pressure level emitted at the work place										
Running at idle (L _{pAd}) (dB)							84			
Running with load (L _{pAd}) (dB)							80			

10.2 Auxiliary materials

Release agent	Order No. 0163333
Pneumatik-oil (0,5 liter)	Order No. 0632579
Anti freeze	Order No. 0631387
Thread sealant (50 ml / 1.7 fl.oz.)*	Order No. 000015
Grease (acid-free)*	Order No. 000025

* Softener for filling the release agent chamber of the fluid pump.

** for maintenance unit

*** Required for maintenance and/or repairs

10.3 Machine card

This User's Handbook is valid only in connection with the following machine card:

The machine card includes all machine specifications and details which are important and relevant for safety:

- exact designation and manufacturing data
- technical specification and limit values
- equipment and inspection certificate
- details and order numbers for spare parts
- machine features (machine components and accessories supplied with spare parts number)



Please pay attention that the machine card specifications are in accordance with the nameplate. In case of any deviations or if the nameplate is missing, we would ask you to advise us without delay.

10.4 Certificate of training and operation

This certificate corresponds to the EU guideline for working substances 85/655/EWG, Paragraph II, Article 7.

The owner of the following machine has trained the operating personnel.

.....
(Make, Model, Year of Construction, Order Number)

The training was conducted by the following designated person:

.....
(Foreman or responsible Superior, Name, Department)

The persons trained have read and understood the user's handbook for the above mentioned machine, especially the chapter Safety, and are certain that they can operate this machine safely.

.....
(Operating Personnel, Date, Name)

.....
(Personnel for Maintenance and Repair, Date, Name)

.....
(Personnel Electric/ Electronics, Date, Name)