

CD-R/RW DRIVE ***CRW2200SX SERIES***

OWNER'S MANUAL
BEDIENUNGSANLEITUNG
MODE D'EMPLOI
MANUAL DE INSTRUCCIONES

English

Deutsch

Français

Español

20x 10x 40x
CD-R CD-RW CD-ROM



FCC INFORMATION

COMPLIANCE INFORMATION STATEMENT

(DECLARATION OF CONFORMITY PROCEDURE)

Responsible Party: Yamaha Electronics Corporation, USA.
Address: 6660 Orangethorpe Avenue
Buena Park, CA 90620
Telephone: 714-522-9105
Fax: 714-670-0108
Type of Equipment: CD Recordable/Rewritable Drive
Model Name: CRW2200SX

This device complies with Part 15 of the FCC Rules.

Operation is subject to the following conditions:

- 1) this device may not cause harmful interference, and
- 2) this device must accept any interference received including interference that may cause undesired operation.

See user manual instructions if interference to radio reception is suspected.

FCC INFORMATION (U.S.A.)

1. IMPORTANT NOTICE: DO NOT MODIFY THIS UNIT!

This product, when installed as indicated in the instructions contained in this manual, meets FCC requirements. Modifications not expressly approved by Yamaha may void your authority, granted by the FCC, to use the product.

- 2. IMPORTANT:** When connecting this product to accessories and/or another product use only high quality shielded cables. Cable/s supplied with this product MUST be used. Follow all installation instructions. Failure to follow instructions could void your FCC authorization to use this product in the USA.

- 3. NOTE:** This product has been tested and found to comply with the requirements listed in FCC Regulations, Part 15 for Class "B" digital devices. Compliance with these requirements provides a reasonable level of assurance that your use of this product in a residential environment will not result in harmful interference with other electronic devices. This equipment generates/uses radio frequencies and, if not installed and used according to the instructions found in the users manual, may cause interference harmful to the operation of other electronic devices. Compliance with FCC regulations does not guarantee that interference will not occur in all installations. If this product is found to be the source of interference, which can be determined by turning the product "OFF" and "ON", please try to eliminate the problem by using one of the following measures:

Relocate either this product or the device that is being affected by the interference.

Utilize power outlets that are on different branch (circuit breaker or fuse) circuits or install AC line filter/s.

In the case of radio or TV interference, relocate/reorient the antenna. If the antenna lead-in is 300 ohm ribbon lead, change the lead-in to coaxial type cable.

If these corrective measures do not produce satisfactory results, please contact the local retailer authorized to distribute this type of product. If you can not locate the appropriate retailer, please contact Yamaha Electronics Corporation, USA, 6660 Orangethorpe Avenue, Buena Park, CA 90620 U.S.A.

LASER INFORMATION

Laser Product Class: Class 1
Laser Diode Properties
Wavelength: 780-787 nm
Pulse Durations and Max. Output at the lens of the Laser Pickup Unit
Read Mode: 0.7mW (Continuous)
Write Mode: Max. 38mW
 (for 166ns, Min. Cycle 86.6ns)

Laserprodukt-Klasse: Klasse 1
Eigenschaften der Laserdiode
Wellenlänge: 780-787 nm
Impulsdauer und max. Ausgang an der Linse der Laser-Abtasteinheit
Lesemodus: 0,7mW (kontinuierlich)
Schreibmodus: Max. 38mW
 (für 166ns, Zyklusmin. 86,6ns)

Classe du produit laser: Classe 1
Caractéristiques de la diode laser
Longueur d'onde: 780-787 nm
Durée des impulsions et sortie maximum depuis la lentille du bloc capteur optique
Mode de lecture: 0,7mW (continue)
Mode de gravure: max. 38mW
 (pour 166ns, cycle min. 86,6ns)

Clase de producto láser: Clase 1
Propiedades del diodo láser
Longitud de onda: 780-787 nm
Duración del pulso y potencia de salida máxima en el objetivo de la unidad captora láser
Modo de lectura: 0,7mW (continua)
Modo de escritura: máx. 38mW
 (para 166ns, ciclo mínimo 86,6ns)

CAUTION
 Use of controls or adjustments or performance of procedures other than those specified herein may result in hazardous radiation exposure.

ACHTUNG
 Halten Sie sich beim Bedienen und Einstellen der Bedienungselemente sowie bei der Bedienungsabfolge an die Anleitung, da sonst gefährliche Strahlen austreten können.

ATTENTION
 L'emploi de commandes, de réglages ou un choix de procédures différents des spécifications de cette brochure peut entraîner une exposition à d'éventuelles radiations pouvant être dangereuses.

PRECAUCION
 El usar los controles o ajustar o realizar procedimientos diferentes a los especificados aquí resultará en peligrosas exposiciones a la radiación.

VARO! AVATTAESSA JA SUOJALUKITUS OHITETTAESSA OLET ALTTINA NÄKYMÄTTÖMÄLLE LASERSÄTEILYLLE. ÄLÄ KATSO SÄTEESEEN.

WARNING! OSYNLIG LASERSTRÅLNING NÄR DENNA DEL ÄR ÖPPNAD OCH SPÄRREN ÄR URKOPPLAD. BETRakta EJ STRÅLEN. STRÅLEN ÄR FARLIG.

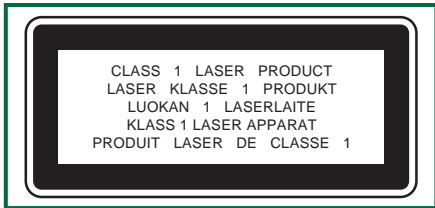

COMPLIES WITH 21 CFR CHAPTER 1, SUBCHAPTER J.

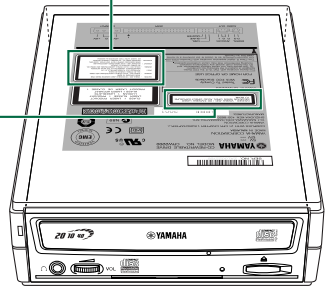



EXTERNAL **SCSI**

CD-R/RW DRIVE
GRW2200SX SERIES

20x 10x 40x
CD-R CD-RW CD-ROM



OWNER'S MANUAL

- Remove dust and dirt from the AC power plug regularly, especially the blades.
Otherwise, dust can build up on the surface of the plug, increasing the risk of fire or insulation failure due to humidity.
- When disconnecting, do not pull on the cord itself.
Do not let objects rest on or roll over the cord.
Otherwise, the cord could be damaged and cause electric shock or fire.
- Insert the plug of the AC adapter firmly.
If the plug is not fully inserted, it can generate heat and may cause electric shock or fire.
- Be sure to use only the included AC adapter.
Otherwise, a malfunction or fire could occur.
- Do not use voltage exceeding the rating of this device.
If too much electricity is drained from one plug (e.g., if too many appliances are plugged into the same socket), it may generate heat and cause fire.

CAUTION

Always follow the basic precautions listed below to avoid the possibility of physical injury to yourself or others, or damage to the instrument or other property. These precautions include, but are not limited to, the following:

- Always unplug the computer from the electrical outlet if it will not be used for a prolonged period of time, or if there is a risk of lightning.
Otherwise, there is an increased risk of electrical shock, short-circuiting, or fire.
- Do not expose the device to excessive heat or vibrations, such as in areas subject to direct sunlight or near a heater.
Also avoid placing it in extreme cold or in areas subject to excessive dust.
Otherwise, the front panel may become disfigured or the internal components may be damaged.
- Do not use the device near other electrical products such as televisions, radios, or speakers.
Otherwise, this may cause interference which can affect the proper operation of those other products.
- Do not place the device in an unstable position.
Otherwise, it may accidentally fall down and be damaged or cause personal injury.
- Mount the device horizontally.
Otherwise, written data may be destroyed. Set the device up according to the instructions in the Owner's Manual.
- Always remove the disc from the disc tray before transporting the device.
Otherwise, written data may be destroyed.
- When cleaning the device, never use benzene, paint thinners, detergents, or chemically coated wiping cloths. Also, do not place vinyl, plastic, or rubber objects on the device.
Otherwise, the device may be damaged or its front panel may become discolored. Use a soft, dry cloth to wipe the device.

- Do not rest your weight on or place heavy objects on the device and do not use excessive force on the buttons, switches or connectors.
Otherwise, there is an increased risk of damage to the device or personal injury.
- Do not listen to audio with headphones at high volume or for prolonged periods of time.
Otherwise, there is an increased risk of hearing loss.
- Before using the device, set the volume dial to its lowest setting.
Otherwise, sudden bursts of sound can cause hearing loss.
- Do not place the device near sources of magnetic interference, such as computer displays.
Magnetic interference can affect the operation and stability of the device.
- Have the device serviced regularly.
Otherwise, dust can build up inside the device, increasing the risk of fire or damage. For information about service charges, contact the store where the device was purchased, or alternatively, the nearest Yamaha dealer (listed at the back of this manual). The device should be serviced about once a year.
- Do not touch the power plug of the AC adapter to any metal.
Otherwise, a short circuit could occur and cause a malfunction.
- Do not wrap the power cord around the AC adapter.
Otherwise, it may become disconnected or cause a malfunction.

■ About CD-R/RW discs

Please read the following regarding the handling of CD-R/RW discs.

1. Do not expose discs to excessive heat, such as in areas subject to direct sunlight or near a heater.
Also, avoid keeping them in a humid place.
2. Do not touch the surface of a disc.
When handling a disc, hold it by its edges.
3. Remove dust and dirt from the surface of a disc.
Use air-based dust removers. The surface of a disc may be scratched if wiped with a dry cloth.
4. Do not stick labels on the surface of a disc.
5. Do not write on the surface of a disc except where indicated.
6. Do not clean discs with chemicals or detergents.
7. Do not bend or drop discs.
8. Do not use irregularly shaped discs, such as a star or a heart or a card shaped, etc.
Such discs could damage your new CD-R/RW drive. (Use only circular discs.)

1. **The information contained in this manual is subject to change without prior notice.**
2. **All trademarks contained in this manual belong to their respective owners.**
3. **Yamaha does not bear any responsibility for a problem that occurs as a result of any operations carried out other than those stated in the manual included with the drive.**
4. **Reproduction of this manual, either in part or in full, is expressly forbidden.**

■ Precautions for Transportation

Before transporting the device, always put it in its original box. If the device is transported without adequate packing, the internal components may be damaged and cause the device to malfunction.

■ Copyrights

When writing to CD-R/RW, make sure that you are not infringing any copyrights. It is illegal to copy audio CDs for non-personal use. When backing up software, please make sure that you are not infringing any software copyrights for that product.

■ WARRANTY

YAMAHA AND ITS SUPPLIERS ACCEPT NO LIABILITY FOR THE LOSS OF ANY DATA OR ANY PROBLEMS CAUSED AS A RESULT. AS A PRECAUTION, IT IS RECOMMENDED THAT THE DISCS BE TESTED AFTER THEY HAVE BEEN WRITTEN TO. FURTHERMORE, UNDER NO CIRCUMSTANCES DOES YAMAHA AND ITS SUPPLIERS GUARANTEE THE RELIABILITY OF THE DISCS.



Table of Contents

Introduction	1
Features of the CRW2200SX Drive.....	1
Before Use	4
System Requirements.....	4
Supported Discs	6
Serial Number	8
Front and Rear of Unit	9
Front Panel	9
Rear Panel	10
Setup Procedures.....	11
Setup Flowchart	11
Set Up the CRW2200SX Drive.....	12
Configuring for the Operating System.....	18
Install the CD Writing Software	20
Operation	21
Loading a Disc	21
Ejecting a Disc	21
Ejecting a Disc in an Emergency	22
Troubleshooting	23
Appendix	28
Writing Modes	28
About the Firmware	30
LED Indicator Messages.....	31
CRW2200SX Specifications	32
Index.....	35

©2001 YAMAHA CORPORATION. All Rights Reserved.

This document may not, in whole or in part, be copied, photocopied, reproduced, translated, transmitted, or reduced to any electronic medium of machine readable form without prior consent in writing from Yamaha.

Windows is a registered trademark of Microsoft Corporation.

Macintosh is a registered trademark of Apple Computer, Inc.

SafeBurn™ is a trademark of Yamaha Corporation.

All other trademarks are the property of their respective companies.

Features of the CRW2200SX Drive

High speed writing/reading

The **CRW2200SX** drive supports up to 20X-speed writing of CD-R discs,*¹ and up to 10X-speed writing/rewriting of CD-RW discs.*² Furthermore, the drive supports data reading and digital audio data extraction at up to 40X speed.

SafeBurn™ (Enhanced write stability technology)

Generous 8MB of buffer memory

Because of the large data storage area, stable disc writing is possible even at fast speeds.

Buffer Underrun Protection

When data transfer from the host PC is interrupted, Buffer Underrun Protection is activated to keep precious CD-R discs from going to waste. (→P. 3)

Optimum Write Speed Control

Before writing to a CD-R, the **CRW2200SX** drive checks the disc's capability and automatically selects the optimum writing speed*³ for greater reliability. The speed you set is the maximum writing speed.

Reliable writing

Yamaha's proprietary Pure-Phase Laser System (patent applied for)

This technology reduces phase interference of the laser beam, so that it projects accurately onto the disc. Jitter value, an important measure of recording quality, has been improved 25% compared with Yamaha models not using this technology.

Running OPC (Optimum Power Control)

Running OPC automatically adjusts the output of the laser according to the characteristics of the disc being used. Running OPC provides greatly enhanced recording reliability for various manufacturer's discs.

High-fidelity digital audio

The **CRW2200SX** drive supports extraction of digital audio data at up to 40X speed, as well as the recording of digital sound with complete fidelity even when writing at 20X speed.

CD TEXT support

Information such as the song name or artist name can be recorded on Audio CDs using CD creation software. The text data on the created disc can be displayed on a CD player that is compatible with the CD TEXT format.

**1 16X- or 20X-speed writing is enabled with the Partial CAV method. (→P. 7)*

**2 10X-speed writing/rewriting is enabled with the CLV method and the 4X-10X Full CAV method. (→P. 8)*

**3 The optimal writing speed automatically selected will be between 8X speed and the maximum speed designated for that disc. If the disc is rated at lower than 8X speed writing, you need to designate the most suitable writing speed manually.*

Buffer Underrun Defined

CD-R/RW drives are equipped with buffer memory. This memory temporarily stores data while a disc is being recorded. When buffer memory becomes empty (due to unexpected interruptions or the system's inability to keep up with the writing process), a writing error occurs. This error is known as a "buffer underrun error."

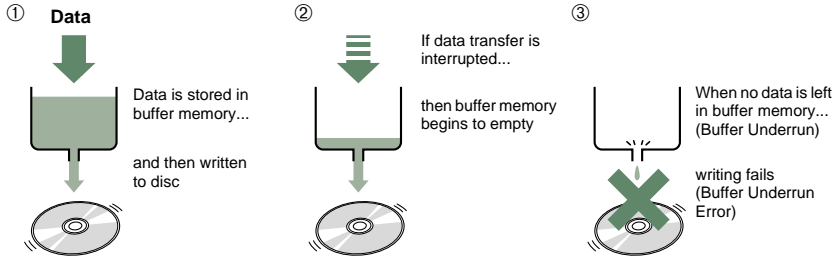

A Buffer Underrun Error will permanently ruin the disc.

Yamaha Buffer Underrun Protection

Buffer Underrun Protection is featured in Yamaha's **CRW2200** series CD-R/RW drives. When a buffer underrun is about to occur, a buffer underrun error is prevented by temporarily suspending the writing process. Writing resumes when enough data has accumulated again in buffer memory. Buffer Underrun Protection on the **CRW2200** series is extremely accurate, resulting in seamless recording between stop and continuation points.

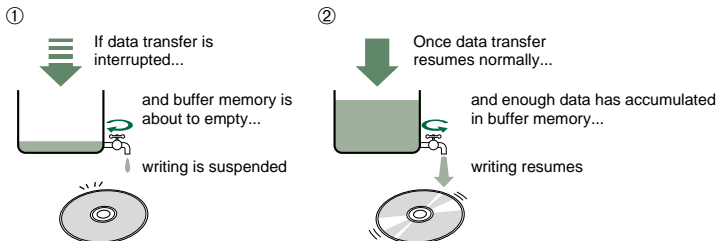

Yamaha Buffer Underrun Protection ensures error-free results.

Test-writing for Buffer Underrun

You can run a check for the likely occurrence of Buffer Underrun by Test-writing a CD-RW disc. The occurrence of a Buffer Underrun depends on your computer system and the CD-R/RW drive.

Most writing software includes test-writing functions to check the likely occurrence of Buffer Underrun before actually writing the disc.

Buffer Underrun Protection is set to ON by default. Test-writing is not available in this setting. To use test-writing with your computer system, the Buffer Underrun Protection should be set to OFF. (For more details, refer to the documentation that came with your CD writing software.)



Before Use

System Requirements

In order to use the **CRW2200SX** drive, your computer system will need to meet the following requirements.

Note

The **CRW2200SX** drive may not write at the maximum speed depending on your computer's system configuration.

Windows Users

Computer

- PC/AT-Compatible Computer
- CPU: Pentium II-class or higher, 300 MHz or faster.
- RAM: 32 MB memory (64 MB or more recommended).

Note

If you are using Windows 2000 Professional operating system, you need 64 MB of memory or more.

- A spare PCI expansion slot for a SCSI card (if one hasn't been installed yet).
- A PCI bus SCSI card (Ultra SCSI compatible with an external SCSI connector, such as Adaptec's AHA-2940 series is recommended).

About SCSI cards

SCSI is a hardware interface that allows for the connection of peripheral devices to the computer.

To use a computer without a SCSI connection, insert a SCSI card into the appropriate PCI slot on your computer. For information on how to install the SCSI card, refer to the documentation that came with it.

Operating System (OS)

Windows 95 (OSR2 or later), Windows 98, Windows 98 Second Edition, Windows Me, Windows NT4.0 with Service Pack 3 or later, Windows 2000 Professional

Macintosh Users

Computer

- Macintosh Computers
- CPU: PowerPC G3, 300 MHz or faster.
- RAM: 32 MB (64 MB or more recommended).
- CD-ROM drive.
- A spare PCI expansion slot for a SCSI card (if one hasn't been installed yet).
- A PCI bus SCSI card (Ultra SCSI compatible with an external SCSI connector, such as Adaptec's PowerDomain 2930 card is recommended).

Note

For details about how to install the SCSI card, refer to the documentation that came with it.

Operating System (OS)

Mac OS 8.1/8.5/8.6/9/9.1 (Except for Classic API with Mac OS X)

CD Writing Software

The **CRW2200SX** drive requires a CD writing software to write onto a CD-R/RW disc. When you use the CD writing software, make sure that it supports the **CRW2200SX** drive.

Note

For details about how to install and use the software, refer to the documentation that came with it.

Hard Drive Space





When writing to a CD-R/RW disc, you will need a working area (50 to 100 MB of free space) on the hard drive. If you want to create an image file containing all the data to be written to the CD-R/RW disc, in addition to the working area, you will need as much hard drive space as that data (up to 900 MB in total). However, this additional hard drive space for the image file is not needed when you are writing directly from a hard drive or CD-ROM drive, etc. (on-the-fly writing).

About disk image files

You can collect data files into a single disk image file for a CD-R/RW disc. Also, note that an image file is useful when writing multiple discs with the same content. For further details, refer to the documentation that came with your CD writing software.

Supported Discs

The **CRW2200SX** drive can write to discs that carry the following logos:

	<p>CD-R discs^{*1}</p> <p>The CRW2200SX drive can write to these discs at 1X, 2X, 4X, 8X, 12X, 16X, or 20X speed. These discs can be played back in a CD-ROM drive or a CD player.</p> <hr/> <p>Notes</p> <ul style="list-style-type: none"> • 16X- or 20X-speed writing is enabled with Partial CAV method. (→P. 7) • For 8X or faster writing, use CD-R discs that match their respective writing speeds.
	<p>CD-RW discs^{*2}</p> <p>There are two types of CD-RW discs: those that support write/rewrite speeds of 1X, 2X, and 4X, and those that support only 2X. The CRW2200SX drive can write/rewrite at 2X or 4X speed on the first type of disc, and at 2X on the second type of disc. These discs can be read/played on a device (e.g., CD-ROM drive) that supports “CD-RW.”</p>
	<p>High Speed CD-RW discs^{*3}</p> <p>These discs allow writing/rewriting at 4X to 10X speeds. The CRW2200SX drive can write/rewrite these discs at 4X, 8X, or 10X speed. These discs can be read/played by a CD-RW drive that bears the High Speed CD-RW logo, or by a device (e.g., CD-ROM drive) that supports “CD-RW.”</p> <hr/> <p>Note</p> <p>10X-speed writing/rewriting is enabled with the CLV method, and the 4X-10X Full CAV method. (→P. 8)</p> <p></p> <ul style="list-style-type: none"> • In order to write, erase, or read these discs using a CD-R/RW drive, a drive bearing the High Speed CD-RW logo must be used. When using a CD-ROM drive to read these discs, the drive must be capable of reading CD-RW discs. • If these discs are used in a CD-R/RW drive not bearing the High Speed CD-RW logo, the discs may not be recognized, resulting in the computer not operating correctly or other malfunctions occurring. • Refer to the page at the URL below before attempting to read these discs on a Yamaha CD-R/RW drive not bearing the High Speed CD-RW logo. URL: http://www.yamaha.co.jp/english/product/computer/

*1 Compatible with Orange Book Part 2.

*2 Compatible with Orange Book Part 3 Vol. 1.

*3 Compatible with Orange Book Part 3 Vol. 2.

Note

To find current information about approved discs for the drive, visit the YAMAHA CD-R/RW Drive web site.

URL: <http://www.yamaha.co.jp/english/product/computer/>

About the Orange Book

The Orange Book standard defines how all recordable discs (including CD-R and CD-RW) are written. Part 2 of the Orange Book standard relates to CD-R discs, and Part 3 to CD-RW discs. The standard was named after the color of the book's cover.

About CD-ROMs

A CD-ROM disc is a compact disc containing high-density read-only data. It has many applications, including the playback of music and video, the archiving of data, as well as on-line documentation. The following are descriptions of each CD-ROM format:

CD-DA: Up to 79 minutes of stereo audio is written in 16-bit resolution at a sampling rate of 44.1 kHz for a 79 minute disc.

Data CD: Up to 700 megabytes of computer data is stored in standard ISO9660 format for a 700 MB disc.

Video CD: These hold movies in which video and audio data has been compressed using MPEG-1 technology.

About Partial CAV (Constant Angular Velocity)

Writing to a CD-R disc is normally done using the CLV (Constant Linear Velocity) method. In this method, the disc rotation speed is adjusted so as to keep a constant data transfer rate at any portion of the disc. In other words, the disc rotation speed will vary in CLV writing.

In contrast, the CAV (Constant Angular Velocity) method uses a constant disc rotation speed for all portions of the disc so that the data transfer rate will vary. Because the CAV method has the advantage of largely increasing the data transfer rate with a minimum load to the drive's mechanism (compared to CLV's rotation speed adjustment), many current CD-ROM drives use the CAV method. CD formats define the constant linear density of written data (data should be written onto the disc at a constant pitch) so that the amount of recorded data per disc rotation will increase as the writing point moves from the inner to the outer. In other words, in CAV writing the outer portion has an increased data transfer rate.

The **CRW2200SX** drive uses the CAV method in the inner portions as well as the CLV method in the outer portions (Partial CAV) in order to enable up to 20X-speed writing. The drive will control the disc rotation speed to start writing at 12X speed in the inner portions, gradually accelerating up to 20X speed and maintaining 20X speed in the outer portions.

About 10X-speed writing/rewriting of a High Speed CD-RW disc

10X-speed writing/rewriting of a High Speed CD-RW disc is enabled with the CLV method, and the 4X-10X Full CAV method. Commonly, writing/rewriting is enabled with the CLV method. When writing/rewriting with packet writing (→P. 29), you can also select the Full CAV method. For more details, refer to the documentation that came with your CD writing software. (Make sure that your CD writing software supports the Full CAV method.) For direct editing of a file on a CD-RW disc, the Full CAV method is recommended.

Serial Number

Once you have taken the **CRW2200SX** drive out of its packaging, you should immediately note down the serial number found at the bottom of the drive with the bar code. You may need to refer to this number when requesting Customer Support services. In the box below the following diagram, write down the 10-character serial number (consisting of 3 letters followed by 7 digits).

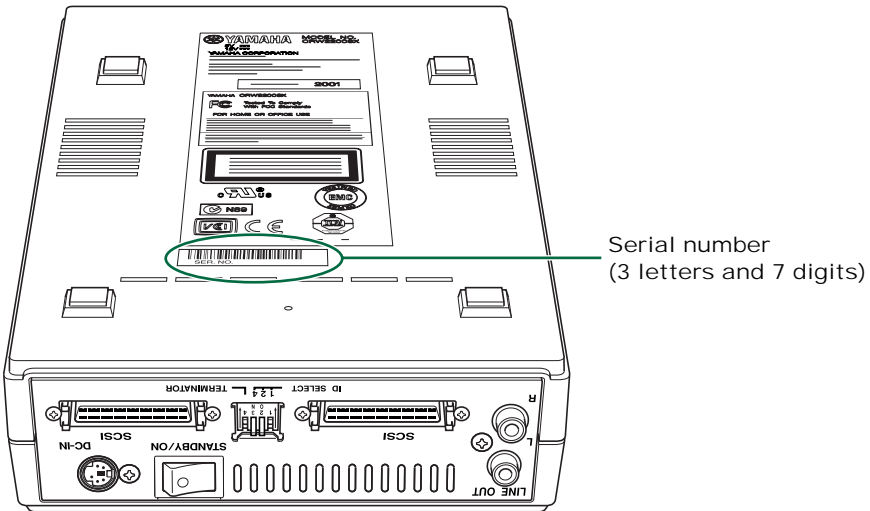

Serial No.									
------------	--	--	--	--	--	--	--	--	--

Front and Rear of Unit

Front Panel

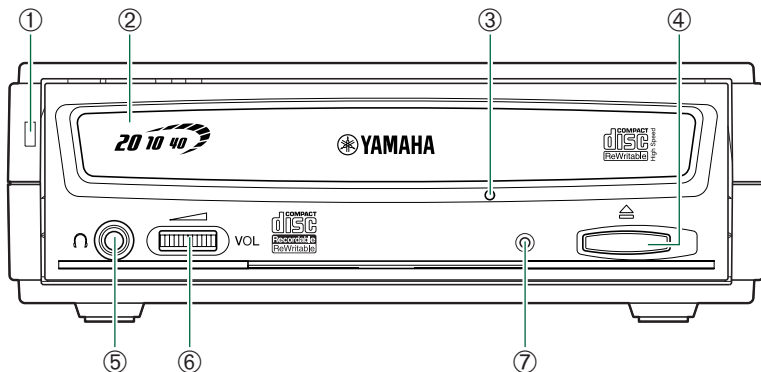

① Power LED

Lights up in green when the power of the drive is turned on.

② Disc tray

The disc tray is used to hold the disc. It slides out from the drive unit when a disc needs to be loaded or unloaded. (→P. 21)

③ Manual eject hole

Only use this if no other method is available for unloading a disc. (→P. 22)

④ Eject button

Press this button when you need to open or close the disc tray. Remove the disc after the disc tray has opened. (→P. 21)

⑤ Headphone jack

You can connect stereo headphones to this stereo mini jack and listen to an audio CD loaded in the drive.

⑥ Headphone volume control

Adjust this control to set a suitable volume level when listening to an audio CD using the headphone jack. Slide the knob to the left to decrease the volume and to the right to increase it.

⑦ LED

Indicates the operation status of the CRW2200SX drive. (→P. 31)

Rear Panel

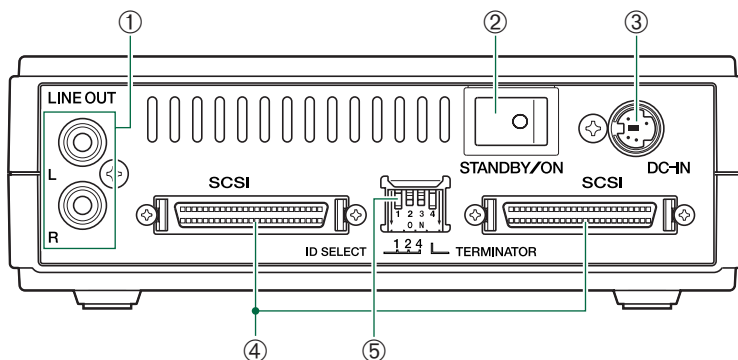

① LINE OUT jacks (L/R)

To listen to audio CDs with the **CRW2200SX** drive, connect these to the line level input (LINE IN) of the stereo equipment with a standard stereo phono cable (sold separately).

② Power switch (STANDBY/ON)

Turns the power on or off. (→P. 14, 17)

③ DC-IN connector

Insert the included AC adapter connector. (→P. 16)

④ SCSI connector

Insert the connector of the SCSI cable here. (→P. 14)

A D-sub half-pitch 50-pin pin-type is used. (→P. 15)

⑤ Dip switch

Use to set the SCSI ID number and terminator. (→P. 12, 13)

Setup Procedures

Make sure that the SCSI card to be connected to the **CRW2200SX** drive is installed beforehand.

Setup Flowchart

For easy cross-referencing, the relevant pages in this manual are given.

STEP Set up the **CRW2200SX** drive

1 (→P. 12 – 17)

1. SCSI settings (→P. 12, 13)
2. Connecting the **CRW2200SX** drive (→P. 14, 15)
3. Connecting the AC adapter (→P. 16, 17)



STEP Configuring for the operating system

2 (→P. 18 – 20)

Check that the **CRW2200SX** drive is recognized correctly.



STEP Install the CD writing software

3

For details about how to install the software, refer to the documentation that came with it.



Start using the **CRW2200SX** drive!

Use the drive to create audio CDs, to back up data on your hard disk, or for whatever purpose suits your needs.

Set Up the CRW2200SX Drive

SCSI Settings

Before connecting the **CRW2200SX** drive to the computer, you need to set up the following using the dip switches located on the rear of the drive.

- ① SCSI ID Number
- ② Termination

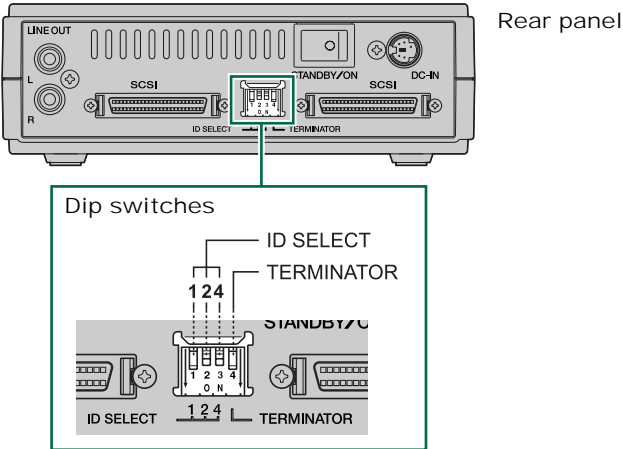

① SCSI ID Number

Each of the SCSI devices connected to the computer is identified by its own SCSI ID number. You need to assign a number from “0” to “7” for each SCSI device. Commonly, ID number “7” is reserved for the computer’s SCSI card itself. Therefore, the **CRW2200SX** drive can actually be assigned an ID number from “0” to “6.” Set the SCSI ID numbers using the three dip switches as shown below.

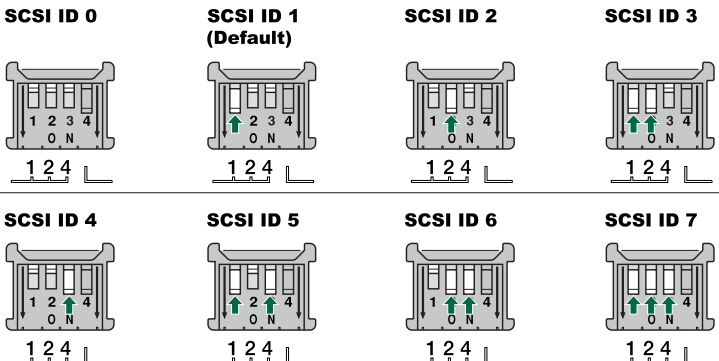

Notes

- The SCSI ID number for each device on the chain must be unique. Make sure the **CRW2200SX** drive's SCSI ID number is not the same as that of any other device on the chain. By factory default, the **CRW2200SX** drive is assigned ID number "1" but this can be changed.
- When setting the dip switch, move the lever completely upward or downward.

② Termination

Terminators prevent SCSI signals from being reflected off the last device in the chain. The SCSI terminator dip switch should be set to ON if the **CRW2200SX** drive is the last device on the SCSI chain. If the **CRW2200SX** drive is not the last device on the chain, the **TERMINATOR** dip switch should be set to OFF.

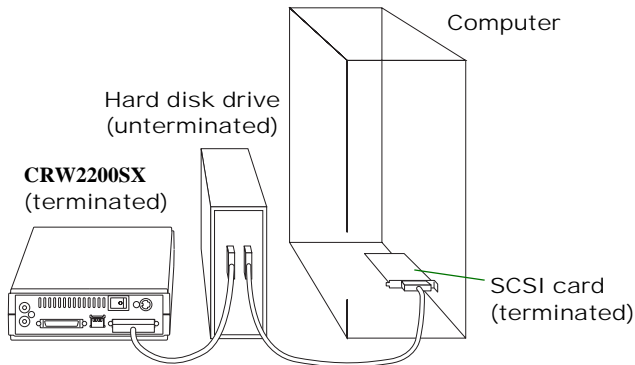

Termination ON (Default)

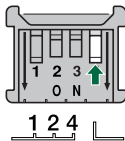

Set to ON if the **CRW2200SX** drive is the last device on the SCSI chain

Termination OFF

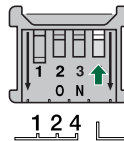

Set to OFF if the **CRW2200SX** drive is not the last device on the SCSI chain

Note

The default setting of the Terminator dip switch is ON.

Connecting the CRW2200SX Drive

- 1 Shut down the computer and all the peripherals.
- 2 Make sure that the power switch on the rear panel of the CRW2200SX drive is set to **STANDBY**.

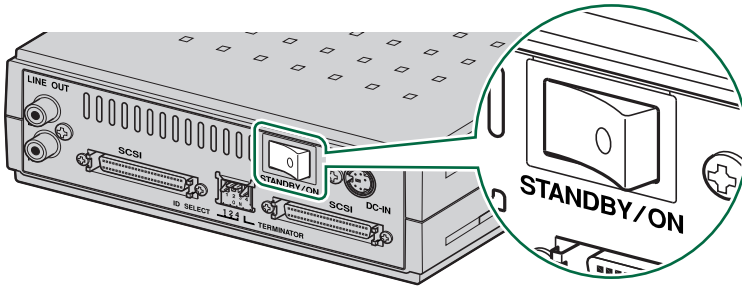

- 3 Connect the SCSI cable to either one of the SCSI card connectors on the rear panel of the CRW2200SX drive.
Connect the other end of the SCSI cable to the SCSI card connector of the computer or the other SCSI device.

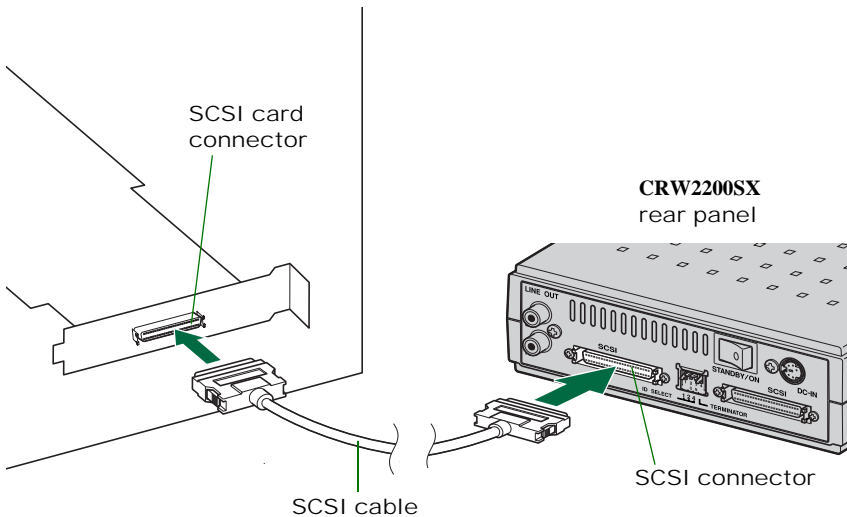

About SCSI cable

- The **CRW2200SX** drive requires a D-sub half-pitch 50-pin pin-type connector. The connector of the SCSI card may vary. You will need to purchase a SCSI cable with connectors suitable for both the drive and the SCSI card. The following are the most common types of SCSI connector:

D-sub half-pitch 50-pin pin-type (as found on the **CRW2200SX** drive)

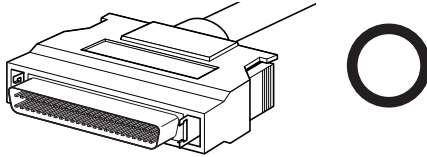

Half-pitch 50-pin Centronics

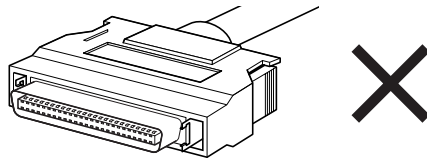

- The total of the length of SCSI cable you will need depends on the number of devices to connect.

The number of devices to connect	The total of the length of SCSI cables
1 to 3 devices	3.0 m or less
4 to 7 devices	1.5 m or less

Note

For stable operations, use the recommended length of SCSI cable.

Example – when connecting 3 devices:

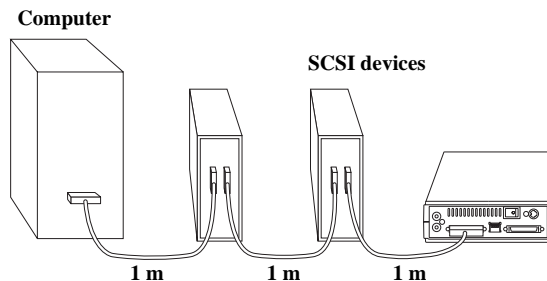

The total of the length of SCSI cables is 3.0 m.

- When you use a SCSI cable, use with an Ultra SCSI mode compatible high impedance cable (characteristic impedance: $100 \pm 10 \Omega$).

Connecting the AC Adapter

- 1 Connect the included AC adapter to the DC-IN connector of the drive with the arrow on the adapter plug facing left, as shown below.

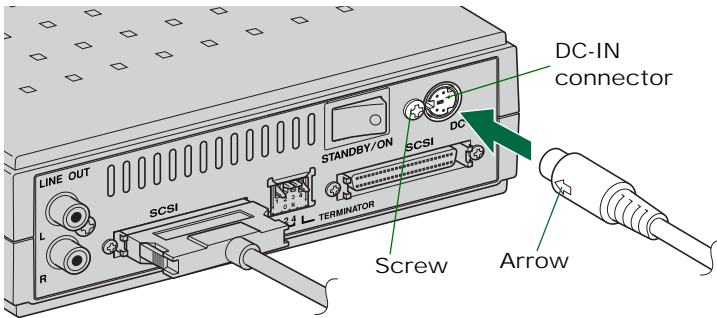

- 2 Connect the included power cable to the AC adapter (①). Connect the other end of the power cable to the AC outlet (②).

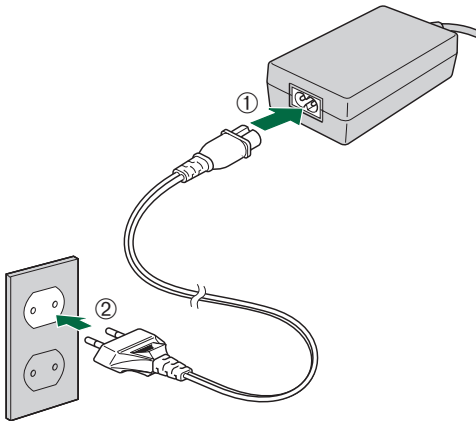

Electrical plugs/sockets vary according to country/region.

Notes

- Operate the drive only with the included AC adapter.
- The bottom of the drive and the AC adapter become warm during use. This is not a malfunction.
- Only by connecting the included AC adapter to a AC outlet, the electric power shown in the table below is consumed. Always unplug the AC adapter from the AC outlet when you do not intend to use the drive for a long time.

AC adapter (model)	Power source	Power consumption
SKB2505A	100 V	2.1 W
	120 V	2.4 W
SMB2505A	220 – 240 V	1.4 W

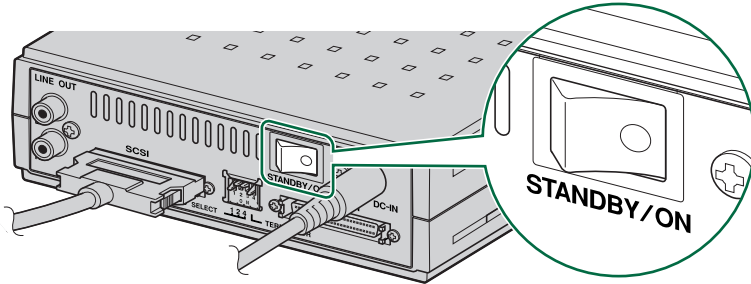
3 Turn on the CRW2200SX drive first, then the computer.

When the power of the **CRW2200SX** drive is turned on, the power LED on the front panel lights up in green.

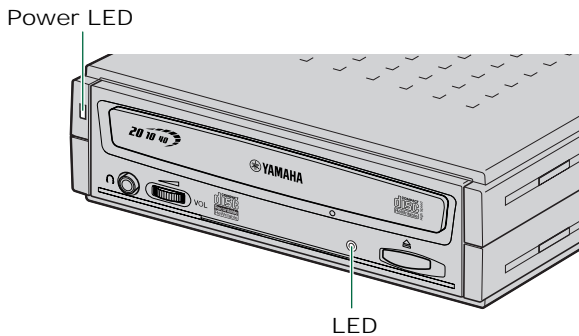
**Note**

When you turn on the **CRW2200SX** drive, make sure the LED on the front panel blinks in green, which indicates that it is reading disc information. (→P. 31)



Always turn on the devices in the SCSI chain before turning on the computer. This will ensure that they are recognized by the computer's operating system.



Do not disconnect any devices in the SCSI chain while the computer is on.

Configuring for the Operating System

Windows Users

- 1 When the computer's operating system is loading, the SCSI card will be recognized and you will be prompted to install the drivers for it. Follow the on-screen instructions and choose to reboot the computer at the end of the driver installation procedure.

Note

For details about installing the drivers for the SCSI card, refer to the documentation that came with it. Also refer to the documentation that came with your computer's operating system.

- 2 After the computer's operating system (Windows 95/98/98 Second Edition/Me) has loaded, open "Control Panel" and double-click on the "System" icon. Select the "Device Manager" tab and double-click on "CDROM." If the drive has been correctly installed, it should be listed as shown below. Similarly, double-click on "SCSI controllers" and the SCSI card should be listed as shown below if it has been properly installed.

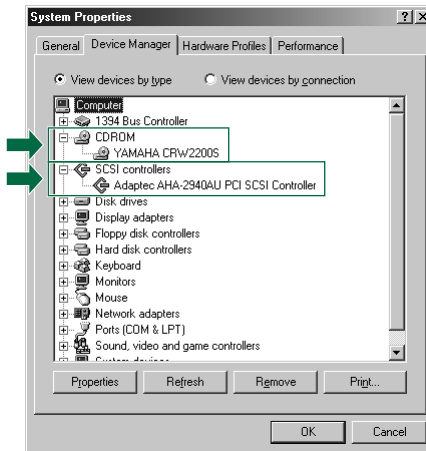

* This is a screen shown in the Windows Me environment.

For Windows NT

You can verify by opening "Control Panel," double-clicking on "SCSI Adapter" and clicking on the "Devices" tab.

For Windows 2000 Professional

You can verify by opening "Control Panel," double-clicking on "System," selecting the "Hardware" tab, and clicking on the "Device Manager" button in "System Properties."

Notes

- For details about how to use the operating system, refer to the documentation that came with it.
- If there is an **X** or **!** mark, etc., next to the icon for the **CRW2200SX** drive or the SCSI card, this means that it has not been installed correctly.

- 3 Double-click on “YAMAHA CRW2200S” listed under “CDROM” (in Windows 95/98/98 Second Edition/Me) and click on the “Settings” tab. Check the “Sync data transfer” checkbox. With “Sync data transfer” enabled, the data transfer between the CRW2200SX drive and the computer is synchronized, meaning that the maximum possible data transfer rate can be achieved.

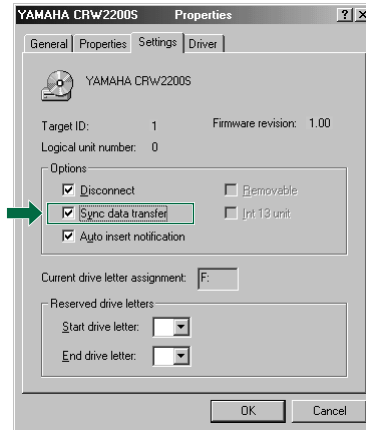

** This is a screen shown in the Windows Me environment.*

Notes

- For details, refer to the documentation that came with the SCSI card.
- When using Windows NT/2000 Professional, “Sync data transfer” will automatically be selected if the SCSI card supports this feature. You will not need to change this setting.

Macintosh Users

To check that the **CRW2200SX** drive is recognized correctly, you will need to use the Apple System Profiler.

- 1 Open “Apple System Profiler” from the Apple menu.
- 2 If you are using Mac OS 8.5 or later, click on the “Devices and Volumes” tab.

Note

For Mac OS 8/8.1, open “Device Information” from “Select” in the menu bar.

- 3 Check that the **CRW2200SX** drive is recognized correctly.

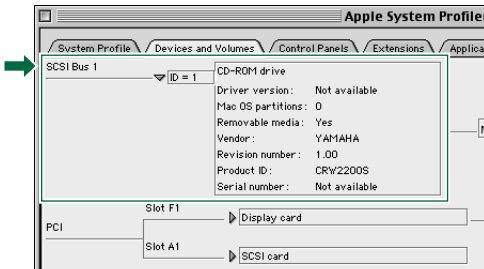

** This is a screen shown in the Mac OS 9.1 environment.*

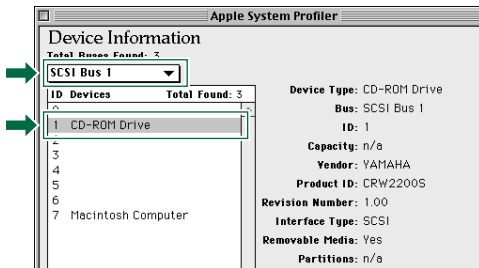

** This is a screen shown in the Mac OS 8.1 environment.*

Note

If the Apple System Profiler recognizes the **CRW2200SX** drive, but extension files supporting the drive are not installed, the disc cannot be mounted or read.

Extension files are included in the CD writing software.

For details, refer to the documentation that came with your CD writing software.

Install the CD Writing Software

For details about how to install and use the software, refer to the documentation that came with it.



Operation

You can load and eject a disc (as described below) only when the **CRW2200SX** drive is turned on.

Loading a Disc

1

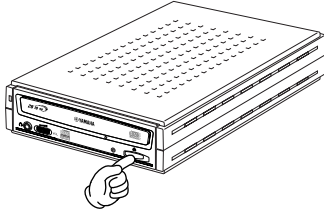

2

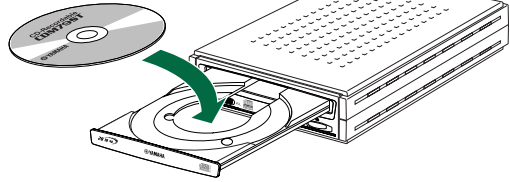

- 1** Open the disc tray by pressing the eject button on the **CRW2200SX** drive's front panel.
- 2** Place the disc onto the disc tray with its label or printing facing upward.
- 3** Close the disc tray by pressing the eject button again. You can also gently push it closed.



Load or unload the disc after the disc tray has fully opened. Do not push or pull the disc tray using excessive force. Doing so can damage the drive or the disc.

Ejecting a Disc

1

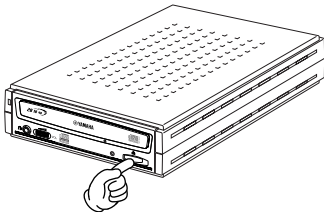

2

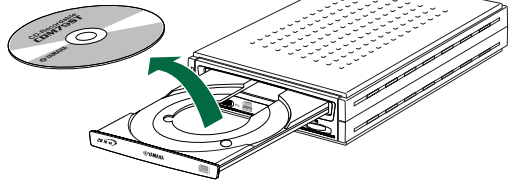

- 1** Open the disc tray by pressing the eject button on the **CRW2200SX** drive's front panel.
- 2** Remove the disc from the disc tray.
- 3** Close the disc tray by pressing the eject button again. You can also gently push it closed.

Notes

- The disc tray will not open if the computer is not turned on. With the **CRW2200SX** drive turned on, pressing the eject button will not open the disc tray if SCSI commands prohibit ejecting a disc, such as during data reading.
- Remove the disc only after the disc tray has opened fully. Otherwise, you risk damaging the drive or the disc.

Ejecting a Disc in an Emergency

If the disc tray fails to open for some reason, such as a malfunction of the internal spring-loaded mechanism or power outage, it can be opened manually.

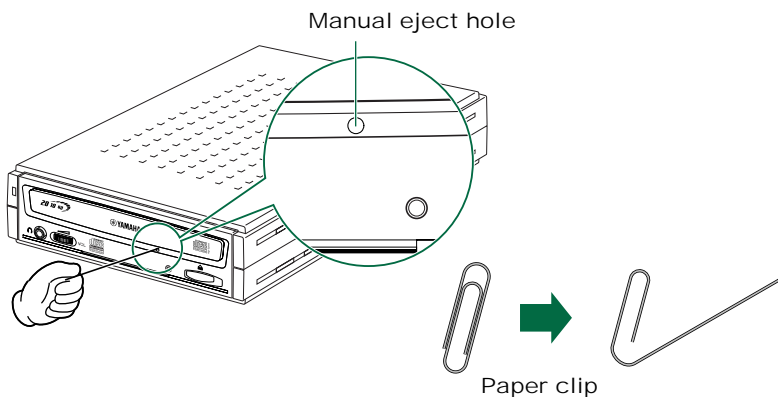

You should attempt to eject a disc manually only as a last resort. Malfunctions may occur if you do this too frequently.

- 1 Shut down the computer and the CRW2200SX drive.**
- 2 Find a pin-like tool with a diameter of 2 mm or less to fit through the manual eject hole on the drive's front panel.**

Note

A straightened large paper clip is ideal for this purpose.

- 3 Push the tool gently into the manual eject hole until the spring-loaded mechanism ejects the disc tray and disc.**
- 4 Turn on the CRW2200SX drive to close the disc tray.**

Troubleshooting

Please refer also to the YAMAHA CD-R/RW Drive web site for more information.

YAMAHA CD-R/RW Drive web site

URL: <http://www.yamaha.co.jp/english/product/computer/>

Europe

URL: <http://www.yamaha-it.de/>

The drive does not turn on.

- Are the AC adapter and the power cable connected correctly?
Make sure that the **CRW2200SX** drive is properly connected to the AC outlet using the included AC adapter and power cable. (→P. 16)
- Make sure that the rear panel power switch is set to ON. As long as the LED on the front panel lights up or blinks in green or orange, the drive is successfully turned on. The problem may not be with the hardware (→P. 26). If the LED doesn't light up or blink, consult your nearest Yamaha dealer for repair.

The computer does not start up.

- Is the SCSI card installed correctly?
Please read the documentation that came with the SCSI card for details.

The **CRW2200SX** drive is not recognized.

- Is the drive's power cable attached correctly, and does the drive turn on? Also, is the SCSI cable connected correctly?
If the system has started up normally, you will be able to see the **CRW2200SX** drive and SCSI card listed in **Control Panel | System | Device Manager** tab. The drive will be listed as "**YAMAHA CRW2200S**" when you double-click on "**CDROM**," and the SCSI card will be listed when you double-click on "**SCSI controllers**." (→P. 18)
When you turn on the computer, you can access the machine's hardware SCSI BIOS settings before Windows is loaded. You can set the computer to recognize the SCSI card and the **CRW2200SX** drive in the BIOS.

Note

Generally, the BIOS (Basic Input / Output System) is a small program that resides on a ROM chip on the computer's motherboard as well as on some expansion cards. It checks the system and its devices (such as serial ports and hard disk controllers) before loading the operating system (OS).

- Are you using the correct SCSI driver (mini-port driver)?
If the SCSI card has not been installed correctly under Windows 95/98/98 Second Edition/Me/NT/2000 Professional, make sure that you have installed the most recent SCSI driver supplied by the SCSI card manufacturer.
For information about the latest version of the driver, please contact the respective SCSI card manufacturer.
- Is the SCSI card recognized correctly by the operating system (OS)?
The SCSI driver for the SCSI card may be incorrect. For more details, contact the SCSI card manufacturer.
- Is the drive's SCSI ID number the same as that of another device on the SCSI chain? (→P. 12)
- Are the pins and holes on the SCSI connectors straight and not deformed?
Check the connectors. (→P. 14)
- Is the terminator of the last device on the SCSI chain set to ON, or, if it has no built-in termination, has a terminator been attached? (→P. 13)
- Is the terminator on the **CRW2200SX** drive set correctly?
It should be set to ON only if it is the last device on the SCSI chain. Otherwise, it should be set to OFF. (→P. 13)
- Check the other SCSI devices to eliminate the possibility of trouble stemming from those devices.
If you use two or more SCSI devices simultaneously, it may cause trouble with the device driver or the data transfer speed. Disconnect other SCSI devices from the computer but leave the **CRW2200SX** drive connected, and be sure that the unit is recognized correctly.
- To write to CD-R/RW discs, your CD writing software must support the **CRW2200SX** drive.
To find out if it does, contact the manufacturer of your CD writing software.

The disc tray does not open.

- Is the **CRW2200SX** drive turned on?
The power LED on the front panel of the **CRW2200SX** drive should light up when power is turned on.
- Some CD writing software will lock the disc tray once loaded.
In this case, use the eject command from within the software. Refer also to the documentation that came with the software.
- For Macintosh users
When the disc's icon is displayed on the screen after a disc is loaded, the eject button cannot be used.
To open the disc tray, drag the disc's icon into the Trash and drop it there to unmount the disc.

- Can you open the disc tray after attempting to restart the computer?
Close all application programs, restart the computer, and press the eject button on the drive's front panel.
- Disconnect the SCSI cable from the **CRW2200SX** drive but leave the AC adapter connected, and press the eject button.
- Manually open the disc tray as a last resort. (→P. 22)
If this trouble occurs frequently, the drive's spring-loaded mechanism may be damaged. Consult your nearest Yamaha dealer for repair.

The disc keeps being ejected.

- Has the disc been placed on the disc tray correctly?
If not, place the disc properly and close the disc tray.
- Has dust or dirt collected on the disc surface?
If so, clean the disc surface using an air spray or by wiping using a lint-free cloth. Remember to wipe the surface from the center of the disc to the edge.
Be careful not to scratch it.
- Does the drive accept other discs (audio CD, CD-ROM, blank CD-R disc, etc.)?
If the drive does not accept a specific disc, the disc itself must be the problem. Check for scratches, warping, or other reasons. If the drive does not accept any disc, consult your nearest Yamaha dealer for repair.

The drive does not operate correctly.

- Is the disc compatible with the **CRW2200SX** drive? (→P. 32)
Even if the disc is of a type compatible with the **CRW2200SX** drive, some varieties of discs may still be unreadable on it. However, blank discs cannot be played.
- Has dust or dirt collected on the disc surface?
If so, clean the disc surface using an air spray or by wiping using a lint-free cloth. Remember to wipe the surface from the center of the disc to the edge.
Be careful not to scratch it.
- For Macintosh users
If extension files supporting the drive are not installed, the disc cannot be mounted or read.
Extension files are included in the CD writing software.
For details, refer to the documentation that came with your CD writing software.
- Is the terminator of the last device in the SCSI chain set to ON, or, if it has no built-in termination, has a terminator been attached? (→P. 13)
- Does your computer have several different CD writing software installed?
If you use two or more CD writing software simultaneously, the behavior of the drive can become unpredictable.

The drive ejects or fails to read the disc, or the LED on the front panel remains lit in orange after the disc has been loaded (meaning that the disc has not been recognized). (→P. 31)

- Shut down the computer. Then disconnect the SCSI cable from the drive but leave the AC adapter connected. Now try loading the disc.
- There may be problems with the disc itself. If the drive fails to recognize a variety of discs including audio CDs, CD-ROMs, and blank CD-R/RW discs (the LED on the front panel remains lit in orange after a disc has been inserted), you should contact your nearest Yamaha dealer.

No sound of CD-DA (audio CD) disc is audible.

- Check that the LINE OUT jacks (L/R) of the **CRW2200SX** drive is connected correctly to the sound card or amplified speakers. (→P. 10)
- For users with Windows Me, no sound is audible from headphones connected to the headphone jack of the **CRW2200SX** drive or from powered speakers connected to the LINE OUT jacks (L/R) on the rear panel of the **CRW2200SX** drive. Make sure settings are as shown below.
(When you are using Windows Media Player 7.0 with Windows Me, the above symptom is known to exist because the default setting is set to ON for “Digital playback.”)

1 The “Properties” setting of the CRW2200SX drive.

- ① Open the “YAMAHA CRW2200S Properties” window and click on the “Properties” tab.
- ② Uncheck the “Enable digital CD audio for this CD-ROM device.” check box.

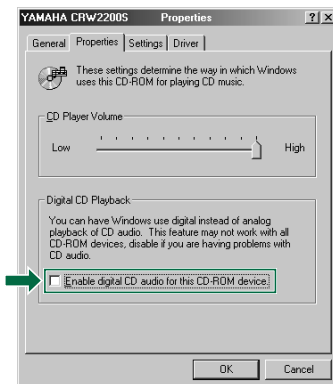

2 The setting of the Windows Media Player.

- ① Start “Windows Media Player.”
- ② Click “Tools” on the Menu and click on “Options” to open the “Options” window, then click on the “CD Audio” tab.
- ③ Uncheck the “Digital playback” check box.

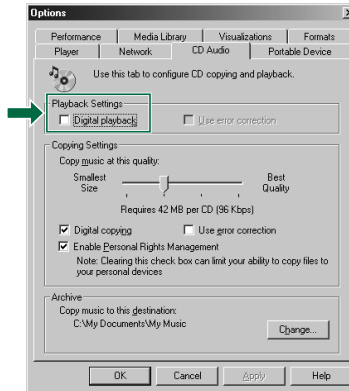

The “Buffer Underrun” error message is displayed.

- If your CD writing software supports the Buffer Underrun Protection, you must activate the Buffer Underrun Protection. For more details, refer to the documentation that came with your CD writing software.
- For more effective writing, and to avoid causing “Buffer Underrun,” try the following:
 - Lower the writing speed setting.
 - Create an image file of the CD on the computer’s hard disk.
 - Optimize the hard drive (Defragment the drive).
 - When writing, close other applications (including screen savers, etc.).
 - Turn hard disk power management off.
 - Select “Sync data transfer” for the transfer mode setting of the SCSI devices, such as a hard drive, or a CD-ROM drive, etc. (→P. 19)
For IDE devices, select “DMA” for the setting of transfer mode.
 - Deactivate the Active Desktop (if you are using Internet Explorer 4 or later).
 - Close residential software.
 - Make sure the trouble does not stem from your CD writing software by referring to the documentation that came with it.

Note

Errors can occur if you knock or move the **CRW2200SX** drive while it is writing to disc.

Writing Modes

Disc-at-Once (DAO)

This mode is used when writing a complete disc in a single pass without pausing. Data cannot be added later, even if the full capacity of the blank disc has not been used.

Example: General CD-ROM

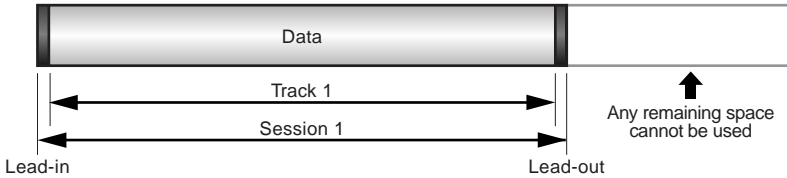

Example: Audio CD

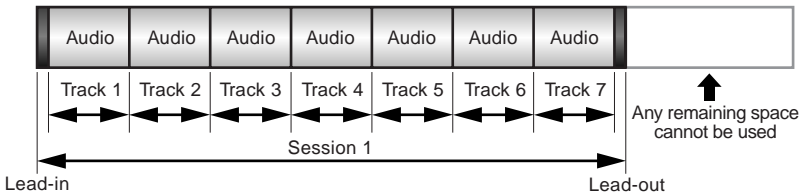

Note

The lead-in and lead-out areas signify the beginning and end points of a session. They are not part of the data but contain information about the session itself. Basically, a session consists of a lead-in, data, and a lead-out.

Track-at-Once (TAO)

This mode is used when writing data to a disc one track at a time. More tracks can be added later if there is enough space left on the disc. This is why Track-at-Once mode is sometimes referred to as Multisession.

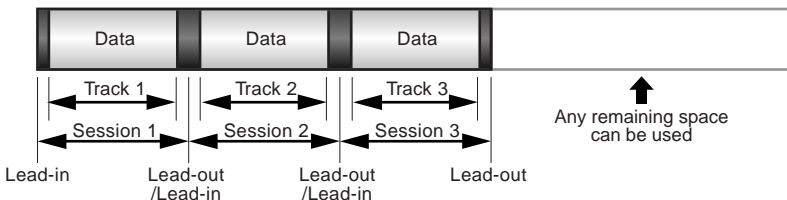

Note

Only the first session of a multisession disc can be played back on a conventional audio CD player. Single session discs can be played back completely.

Session-at-Once (SAO)

As a writing method that combines the advantages of the above-mentioned “Disc-at-Once” and “Track-at-Once,” you can combine multiple tracks into one session and write them, and then add additional data.

For example, this is the writing method used to create a CD EXTRA format CD. The music tracks will be recorded in the first session, and the data will be recorded in the second session.

Example: CD EXTRA

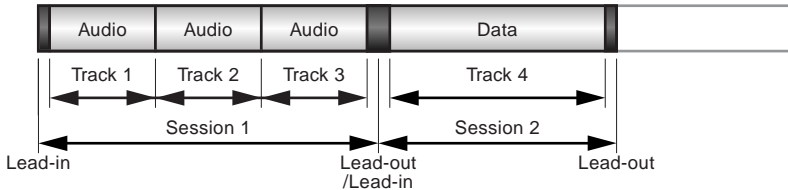

Packet Writing

This mode is used when writing to a track of a disc using small blocks of data called “packets,” in a manner similar to a floppy disk. This mode is useful when making small incremental backups of data. You will need to use software that specifically supports packet writing.

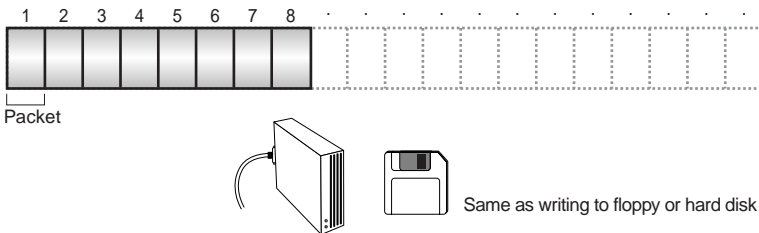

Notes on Packet Writing

- Discs must be formatted before they can be used for packet writing. With CD-RW, erased data can be overwritten until the disc is completely full.
- When using packet writing on a CD-RW disc, the actual data capacity is 100MB less than that stated on the cover of the disc. The difference in capacity is dependent on the writing mode.
- With CD-R, the space used by the erased data cannot be reused and is “masked” so that it is no longer visible. This can be done up to 100 times.

About the Firmware

The firmware is a small piece of software built into the **CRW2200SX** drive, and is used to operate the drive. Since it resides in flash memory, it can be overwritten and updated. To ensure more reliable operations and enhanced performance of the drive, updates to the firmware will be made available. You can find information about the most recent firmware for the drive on the YAMAHA CD-R/RW Drive web site.

YAMAHA CD-R/RW Drive web site

URL: <http://www.yamaha.co.jp/english/product/computer/>

Europe

URL: <http://www.yamaha-it.de/>

The most recent user support information, including firmware updates, can be found in the YAMAHA CD-R/RW Drive web site. Please check this information regularly.

Determining the Firmware Version of the CRW2200SX Drive

For Windows 95/98/98 Second Edition/Me

Go to **Control Panel | System | Device Manager** tab, double-click on “**CDROM,**” then double-click on “**YAMAHA CRW2200S.**”

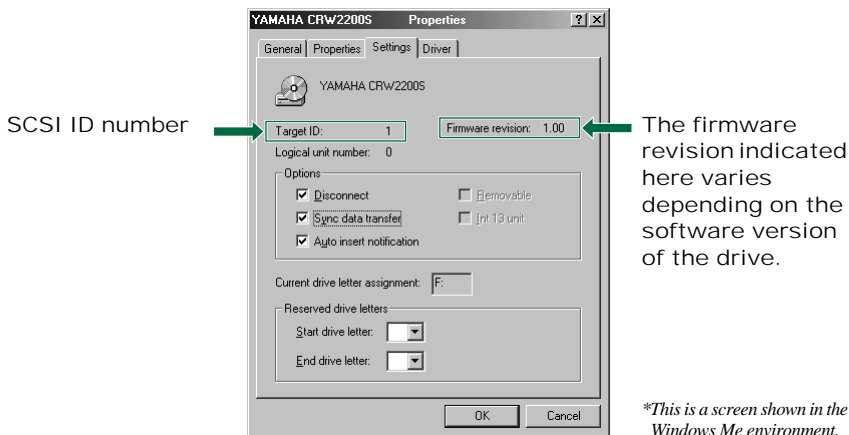

For Windows NT

You can verify by opening “Control Panel,” double-clicking on “SCSI Adapter,” and clicking on the “Devices” tab. Then right-click on “YAMAHA CRW2200S,” and select “Properties.”

For Windows 2000 Professional

If you open the “Device Manager” window, the firmware version will not be displayed. Use your CD writing software to check the firmware version.

Macintosh Users

Use Apple System Profiler to check the firmware version of the **CRW2200SX** drive. (→P. 20)

LED Indicator Messages

The following table shows the various LED signals and meanings when the **CRW2200SX** drive is turned on.

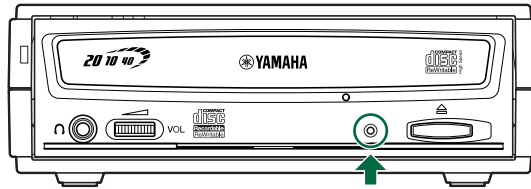

Status	Indicator Messages	LED Color
Ready (with disc)	Lit	Green
Ready (no disc)	Lit	Orange
Tray operation (opening/closing)	Blinking (constant)	Green
Tray fully opened	Out	—
Reading disc information (TOC)	Blinking (constant)	Green
Initial access in writing	Blinking (constant)	Orange
Writing (test mode)	Blinking (constant)	Orange
Writing	Blinking fast (constant)	Orange
Reading	Flashing (inconstant)	Green
Playing	Blinking fast (constant)	Green
Power saving (combined with the computer's power saving)	Out	—
Failure	Flashing (inconstant)	Orange

CRW2200SX Specifications

Supported Formats

	Write	Read	Play
CD-DA	●	●	● (*4)
CD TEXT	●	●	●
CD-ROM (*1)	●	●	●
Mixed Mode CD-ROM (CD-ROM+CD-DA)	●	●	● (*4)
CD-ROM XA (*1)	●	●	● (*4)
Photo CD (*1)	● (*2)(*3)	●	● (*4)
Video CD	●	●	● (*4)
CD-i	●	● (*3)	
CD EXTRA (*1)	●	●	● (*4)

*1: includes multisession

*2: suitable disc required

*3: suitable application
software required*4: suitable application software
required for playback

Note

Excludes ADPCM Encode/Decode & Video Encode/Decode functions.

CRW2200SX

Writing Methods

Disc-at-Once (DAO)
Session-at-Once (SAO)
Track-at-Once (TAO)
Packet Writing

Writing/Reading Speed

Writing	CD-R	1X, 2X, 4X, 8X, 12X (CLV), 16X (12X – 16X Partial CAV), 20X (12X – 20X Partial CAV)
	CD-RW	2X, 4X, 8X, 10X (CLV) 4X – 10X Full CAV
Reading	40X (max.) Full CAV	
	Note)	<ul style="list-style-type: none"> • DATA: 40X (max.) • CD-DA: 40X (max.) in audio extraction • CD-DA: 1X only in audio play • Video CD: 10X (max.) • Session closed disc: 40X (max.) • Session unclosed disc: 12X (max.)

CD-R 1X, 2X, 4X, 8X, 12X, 16X (12X – 16X Partial CAV),
20X (12X – 20X Partial CAV) writing:
CD-R discs specified in Orange Book Part II Ver. 3.1.
Note) For 8X or faster writing, use CD-R discs matched their
respective writing speeds.

CD-RW

- 2X writing/rewriting: Rewritable discs specified in Orange Book Part III Volume 1 Version 1.0.
- 2X or 4X writing/rewriting: Rewritable discs specified in Orange Book Part III Volume 1 Version 2.0.
- 4X, 8X, 10X (CLV), 4X – 10X Full CAV writing/rewriting: Rewritable discs specified in Orange Book Part III Volume 2 Version 1.0.

Data Capacity	700 MB (79 min.) 650 MB (74 min.) 550 MB (63 min.)
Data Transfer Rate (Mode 1)	1X: 150 KB/sec. 16X: 2,400 KB/sec. 2X: 300 KB/sec. 20X: 3,000 KB/sec. 4X: 600 KB/sec. 24X: 3,600 KB/sec. 8X: 1,200 KB/sec. 32X: 4,800 KB/sec. 10X: 1,500 KB/sec. 40X: 6,000 KB/sec. 12X: 1,800 KB/sec.
Burst Transfer Rate	5 MB/sec. (max, asynchronous) 20 MB/sec. (max, synchronous)
Data Buffer Size	8 MB (3,224 sectors)
Average Random Access Time	150 msec. (reading)
Sector Size	2,048 – 2,352 bytes
Interface	SCSI-3 (Ultra SCSI)
Installing Style	Horizontal
Disc Loading Type	Front auto-loading tray loading
Audio Out	Line Out Frequency range: 20 – 20,000 Hz Output level: 700 mVrms
Power Consumption	SKB2505A (100 – 120 V AC) : • 17 W (when writing or reading) • 9 W (standby) SMB2505A (220 – 240 V AC) : • 17 W (when writing or reading) • 8 W (standby)
Operating Environment	Temperature 5 – 35 °C Humidity 25 – 80% RH (no condensation)
Dimension (includes projection)	Width: 164.0 mm Height: 56.0 mm Depth: 266.2 mm
Weight	1.5 kg

AC adapter

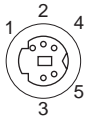
Rated Input Voltage	SKB2505A : 100 – 120 V AC ± 10% SMB2505A : 220 – 240 V AC ± 10%
Rated Input Current	SKB2505A : 0.64A (100 – 120 V AC) SMB2505A : 0.4A (220 – 240 V AC)
Rated Output Voltage	+5 V, +12 V DC
Rated Output Current	1.5 A
Terminal Output Polarity	 <p>1 : +12 V DC 2 : GND 3 : +5 V DC 4 : GND 5 : +5 V DC</p>
Operating Environment	Temperature 0 – 40 °C Humidity 20 – 90% RH (no condensation)
Dimension (includes projection)	Width: 63.0 mm Height: 31.5 mm Depth: 112.0 mm
Weight (includes the power cable)	SKB2505A : 400 g (approx.) SMB2505A : 350 g (approx.)

The CRW2200SX series complies with the following specifications

Country / Region	Compliance Specifications			Details
	Category	Item	Standards	
USA	Safety	Electrical	UL60950	Information Technology Equipment
		Laser	21CFR1040.10 FDA Chapter 1, Subchapter J	Class 1 Laser Product
	EMC	Emission	47CFR15 FCC Part 15, Subpart B	Class B Computing Device
Canada	Safety	Electrical	CSA C22.2 No. 60950	Information Technology Equipment
	EMC	Emission	ICES-003	Class B Computing Device
EU	Safety	Electrical	EN60950	Information Technology Equipment
		Laser	EN60825	Class 1 Laser Product
	EMC	Emission	EN55022	Class B Information Technology Equipment
		Immunity	EN55024 EN61000-3-2 EN61000-3-3	Information Technology Equipment
Australia New Zealand	EMC	Emission	AS/NZ 3548	Class B Equipment
Japan	EMC	Emission	VCCI	Class B Equipment

Index

A

AC adapter	16
Apple System Profiler.....	20
Audio CD	28

B

BIOS	23
Buffer Underrun.....	3
Buffer Underrun Error	3
Buffer Underrun Protection	1, 3

C

CAV	7
CD EXTRA.....	29
CD TEXT.....	2
CD Writing Software	5
CD-DA.....	7
CD-R discs	6
CD-ROM.....	7, 28
CD-RW discs	6
CLV	7
Configuring for the Operating System	18
Control Panel	18

D

Data CD	7
DC-IN connector.....	10, 16
Device Manager	18
Dip switch	10, 12
Disc tray	9, 21
Disc-at-Once (DAO).....	28
Disk image files	5
D-sub half-pitch 50-pin pin-type	15

E

Eject button	9, 21
Ejecting a Disc	21
Ejecting a Disc in an Emergency	22
Extraction of digital audio data.....	1

F

Firmware	30
Front Panel.....	9
Full CAV.....	8

H

Half-pitch 50-pin Centronics	15
Hard Drive Space.....	5
Headphone jack.....	9
Headphone volume control	9
High Speed CD-RW discs	6

J

Jitter value.....	1
-------------------	---

L

Lead-in	28
Lead-out	28
LED	9, 17, 31
LINE OUT jacks (L/R)	10
Loading a Disc	21

M

Manual eject hole.....	9, 22
Multisession	28

O

Optimum Write Speed Control	1
Orange Book	7

P

Packet.....	29
Packet Writing	29
Paper clip	22
Partial CAV	7
Power cable	16
Power LED.....	9, 17
Power switch.....	10, 14, 17
Pure-Phase Laser System.....	1

R

Rear Panel.....	10
Running OPC	1

S

SafeBurn™ 1
SCSI cable 14, 15
SCSI card 4, 5
SCSI connector 10, 14
SCSI driver 24
SCSI ID number 12, 30
Serial Number 8
Session 28
Session-at-Once (SAO) 29
Single session 28
Supported Discs 6
Supported Formats 32
Sync data transfer 19
System Requirements 4

T

Termination 13
Test-writing 3
Track 28
Track-at-Once (TAO) 28

V

Video CD 7

W

Writing Modes 28

Y

YAMAHA CD-R/RW Drive web site
..... 6, 23, 30

Distributors and Head Offices / Vertriebs- und Hauptgeschäftsstelle Distributeurs et sièges sociaux / Distribuidores y Casas matrices

If you have any questions, please contact your dealer or one of the following companies.

Bei weiteren Fragen wenden Sie sich bitte an Ihren Händler oder eine der folgenden Firmen.

Pour plus de détails sur les produits, veuillez vous adresser à Yamaha ou au distributeur le plus proche figurant dans la liste suivante :

Si tiene alguna pregunta, por favor póngase en contacto con su distribuidor o una de las siguientes empresas:

EUROPE, EASTERN EUROPE and RUSSIA

**Yamaha Elektronik Europa GmbH
IT-Sales Division**
Siemensstrasse 22-34,
D-25462 Rellingen, GERMANY
URL: <http://www.yamaha-it.de/>

TEL: +80092624222
(AUSTRIA, BELGIUM, DENMARK, FINLAND,
FRANCE, GERMANY, HUNGARY, ICELAND,
IRELAND, ITALY, LUXEMBOURG,
NETHERLANDS, NORWAY, PORTUGAL,
SPAIN, SWEDEN, SWITZERLAND, UNITED
KINGDOM)

TEL: +80093067
(MONACO)

If you are calling from outside the countries mentioned
above, or if you can't get through on the Yamaha toll-
free number, use the following number instead:

TEL: +3214400793

U.S.A.

Yamaha Electronics Corporation, USA
6660 Orangethorpe Avenue,
Buena Park, CA 90620, U.S.A.
TEL: +1 714 522 9105
FAX: +1 714 670 0108
URL: <http://www.yamaha.com/>

CANADA

Yamaha Canada Music Ltd.
135 Milner Avenue, Scarborough,
Ontario M1S 3R1, CANADA
TEL: +1 416 298 5664
FAX: +1 416 292 0732
URL: <http://www.yamaha.ca/>

AUSTRALIA

Yamaha Music Australia Pty., Ltd.
Level 1, 99 Queensbridge Street
Southbank, Victoria 3006
AUSTRALIA
TEL: +61 3 9693 5111
FAX: +61 3 9699 2332

SINGAPORE, MALAYSIA, THAILAND, PHILIPPINES, INDIA, VIETNAM, CAMBODIA, MYANMAR, INDONESIA and IRAN

Yamaha Electronics Asia Pte Ltd.
138 Cecil Street
#05-02/03 Cecil Court, Singapore 069538
SINGAPORE
TEL: +65 223 3992
FAX: +65 223 9810

TAIWAN

Yamaha KHS Music Co., Ltd.
11F, No.150, Tun Hua North Rd.
Taipei, TAIWAN R.O.C.
TEL: +886 2 2713 8999
FAX: +886 2 2713 8666
URL: <http://www.yamahakhs.com/>

JAPAN

**Yamaha Corporation
AV & IT Business Group
IT Sales & Marketing Division**
203 Matsunokijima, Toyooka-mura, Iwata-gun,
Shizuoka-ken 438-0192, JAPAN
TEL: +81 539 62 6558
FAX: +81 539 62 5346
URL: <http://www.yamaha.co.jp/english/>



COMPACT
disc
Recordable
ReWritable

COMPACT
disc
ReWritable
High Speed

YAMAHA CORPORATION
X0406A0 CRW2200SX(W)
Printed in Malaysia