

# MODEL W1686 SPINDLE SANDER



## INSTRUCTION MANUAL

Phone: 1-360-734-3482 • On-Line Technical Support: [tech-support@woodstockint.com](mailto:tech-support@woodstockint.com)

COPYRIGHT © AUGUST, 2002 BY WOODSTOCK INTERNATIONAL, INC.

WARNING: NO PORTION OF THIS MANUAL MAY BE REPRODUCED IN ANY SHAPE OR FORM WITHOUT  
THE WRITTEN APPROVAL OF WOODSTOCK INTERNATIONAL, INC.

Printed in Taiwan

#### ONLINE MANUAL DISCLAIMER

THE INFORMATION IN THIS MANUAL REPRESENTS THE CONFIGURATION OF THE MACHINE AS IT IS CURRENTLY BEING SHIPPED. THE MACHINE CONFIGURATION CAN CHANGE AS PRODUCT IMPROVEMENTS ARE INCORPORATED. IF YOU OWN AN EARLIER VERSION OF THE MACHINE, THIS MANUAL MAY NOT EXACTLY DEPICT YOUR MACHINE. CONTACT CUSTOMER SERVICE IF YOU HAVE ANY QUESTIONS ABOUT DIFFERENCES. PREVIOUS VERSIONS ARE NOT AVAILABLE ONLINE.

# WARNING

Some dust created by power sanding, sawing, grinding, drilling, and other construction activities contains chemicals known to the State of California to cause cancer, birth defects or other reproductive harm. Some examples of these chemicals are:

- Lead from lead-based paints.
- Crystalline silica from bricks, cement, and other masonry products.
- Arsenic and chromium from chemically treated lumber.

Your risk from these exposures varies, depending on how often you do this type of work. To reduce your exposure to these chemicals: work in a well ventilated area, and work with approved safety equipment, such as those dust masks that are specially designed to filter out microscopic particles.

# TABLE OF CONTENTS

	PAGE
1. INTRODUCTION .....	2
About Your New Sander .....	2
Woodstock Service And Support .....	2
Warranty And Returns .....	3
Machine Specifications .....	3
2. SAFETY .....	4
Standard Safety Instructions .....	4-5
Additional Safety Instructions For Sander .....	6
Avoiding Potential Injuries .....	7
3. ELECTRICAL REQUIREMENTS .....	8
110V Operation .....	8
Extension Cords .....	8
Grounding .....	8
220V Operation .....	9
Extension Cords .....	9
Grounding .....	9
3. ASSEMBLY INSTRUCTIONS .....	10
Unpacking .....	10-11
Clean Up .....	12
General .....	13
Table/Trunnion .....	13
Dust Port .....	14
Sanding Spindle .....	15-16
Sanding Sleeve .....	17
Table Insert .....	18
4. ADJUSTMENTS .....	19
Positive Stop Bolt .....	19-20
5. OPERATIONS .....	21
Test Run .....	21
Standard Sanding Procedures .....	22
Bevel Sanding Procedures .....	23
6. MAINTENANCE .....	24
General .....	24
Cleaning .....	24
Table And Base .....	24
Sanding Sleeves .....	25
Lubrication .....	25
7. CLOSURE .....	26
Wiring Diagram .....	27
Parts Breakdown And Parts List .....	28-31
Notes .....	32
Warranty .....	33

USE THE QUICK GUIDE PAGE LABELS TO SEARCH OUT INFORMATION FAST!





---

# INTRODUCTION

## About Your New Sander

Your new SHOP FOX® W1686 has been specially designed to provide many years of trouble-free service. Close attention to detail, ruggedly built parts and a rigid quality control program assure safe and reliable operation.

The Model W1686 is capable of a wide variety of sanding operations. Features include a 1 HP 110/220V single-phase 1725 RPM motor, a 72 strokes per minute (SPM) oscillation rate, a precision-ground cast iron table that measures 27 9/16" x 27 9/16", a 45° front and 20° back table tilting capacity, a 4" dust port, and large assortment of rubber sanding spindles. Whether used in a professional setting or a home shop, the Model W1686 will be well appreciated as a fine woodworking machine.

Woodstock International, Inc. is committed to customer satisfaction in providing this manual. It is our intent to make sure all the information necessary for safety, ease of assembly, practical use and durability of this product be included.

If you should have any comments regarding this manual, please feel free to contact us at:

Woodstock International, Inc.  
Attn: Technical Department  
P.O. Box 2309  
Bellingham, WA 98227

## Woodstock Service And Support

We stand behind our machines! In the event that a defect is found, parts are missing or questions arise about your machine, please contact Woodstock International Service and Support at 1-360-734-3482 or send e-mail to: [tech-support@woodstockint.com](mailto:tech-support@woodstockint.com). Our knowledgeable staff will help you troubleshoot problems, send out parts or arrange warranty returns.

# Warranty And Returns

Woodstock International, Inc. warrants all SHOP FOX® machinery to be free of defects from workmanship and materials for a period of 2 years from the date of original purchase by the original owner. This warranty does not apply to defects due directly or indirectly to misuse, abuse, negligence or accidents, lack of maintenance, or to repairs or alterations made or specifically authorized by anyone other than Woodstock International, Inc.

Woodstock International, Inc. will repair or replace, at its expense and at its option, the SHOP FOX® machine or machine part which in normal use has proven to be defective, provided that the original owner returns the product prepaid to the SHOP FOX® factory service center or authorized repair facility designated by our Bellingham, WA office, with proof of their purchase of the product within 2 years, and provides Woodstock International, Inc. reasonable opportunity to verify the alleged defect through inspection. If it is determined there is no defect, or that the defect resulted from causes not within the scope of Woodstock International Inc.'s warranty, then the original owner must bear the cost of storing and returning the product.

This is Woodstock International, Inc.'s sole written warranty and any and all warranties that may be implied by law, including any merchantability or fitness, for any particular purpose, are hereby limited to the duration of this written warranty. We do not warrant that SHOP FOX® machinery complies with the provisions of any law or acts. In no event shall Woodstock International, Inc.'s liability under this warranty exceed the purchase price paid for the product, and any legal actions brought against Woodstock International, Inc. shall be tried in the State of Washington, County of Whatcom. We shall in no event be liable for death, injuries to persons or property or for incidental, contingent, special or consequential damages arising from the use of our products.

Every effort has been made to ensure that all SHOP FOX® machinery meets high quality and durability standards. We reserve the right to change specifications at any time because of our commitment to continuously improve the quality of our products.

# Machine Specifications

Motor Size: .....	1 HP 110/220V Single-Phase
Motor Speed .....	1725 RPM
Amps .....	14/7
Spindle Size.....	1/4" x 5", 3/8" x 6", 1/2" x 6", 5/8" x 6", 3/4" x 9", 1" x 9", 1 1/2" x 9", 2" x 9", 3" x 9", 4" x 9"
Oscillation Speed .....	72 SPM
Stroke Length.....	1 1/2"
Base Size .....	16" x 16"
Dust Port .....	4"
Table .....	Precision-Ground Cast Iron 27 <sup>9</sup> / <sub>16</sub> " x 27 <sup>9</sup> / <sub>16</sub> "
Stand .....	Cabinet-Style, Powder Coated Paint
Power Transfer .....	Direct Drive
Bearings .....	Sealed & Permanently Lubricated Ball Bearings
Switch .....	Paddle ON/OFF Switch, w/ Safety Lock Key
Shipping Weight .....	287 lbs.

# SAFETY

**READ MANUAL BEFORE OPERATING MACHINE.  
FAILURE TO FOLLOW INSTRUCTIONS BELOW WILL  
RESULT IN PERSONAL INJURY.**



Indicates an imminently hazardous situation which, if not avoided, **WILL** result in death or serious injury.



Indicates a potentially hazardous situation which, if not avoided, **COULD** result in death or serious injury.



Indicates a potentially hazardous situation which, if not avoided, **MAY** result in minor or moderate injury. It may also be used to alert against unsafe practices.

## NOTICE

This symbol is used to alert the user to useful information about proper operation of the equipment.

## Standard Safety Instructions

1. **Thoroughly read the instruction manual before operating your machine.** Learn the applications, limitations and potential hazards of this machine. Keep manual in a safe, convenient place for future reference.
2. **Keep work area clean and well lighted.** Clutter and inadequate lighting invite potential hazards.
3. **Ground all tools.** If a machine is equipped with a three-prong plug, it must be plugged into a three-hole grounded electrical receptacle or grounded extension cord. If using an adapter to aid in accommodating a two-hole receptacle, ground using a screw to a known ground.
4. **Wear eye protection at all times.** Use safety glasses with side shields or safety goggles that meet the national safety standards, while operating this machine.
5. **Avoid dangerous environments.** Do not operate this machine in wet or open flame environments. Airborne dust particles could cause an explosion and severe fire hazard.
6. **Ensure all guards are securely in place and in working condition.**
7. **Make sure switch is in the OFF position** before connecting power to machine.
8. **Keep work area clean, free of clutter, grease, etc.**
9. **Keep children and visitors away.** Visitors should be kept at a safe distance while operating unit.
10. **Childproof workshop** with padlocks, master switches or by removing starter keys.
11. **Disconnect machine when cleaning, adjusting or servicing.**

12. **Do not force tool.** The machine will do a safer and better job at the rate for which it was designed.
13. **Use correct tool.** Do not force machine or attachment to do a job for which it was not designed.
14. **Wear proper apparel.** Do not wear loose clothing, neck ties, gloves, jewelry, keep long hair tied up, etc.
15. **Remove adjusting keys and wrenches.** Before turning the machine on, make it a habit to check that all adjusting keys and wrenches have been removed.
16. **Use proper extension cord.** Examine the extension cord to ensure it is in good condition. Use the chart below to determine the correct length and gauge of extension cord needed for your particular needs. The amp rating of the motor can be found on its nameplate. If the motor is dual voltage, be sure to use the amp rating for the voltage you will be using. If you use an extension cord with an undersized gauge or one that is too long, excessive heat will be generated within the circuit increasing the chance of a fire or damage to the circuit. Never use an extension cord that does not have a ground pin and connected ground wire. Immediately replace an extension cord if it shows any signs of damage.
17. **Keep proper footing and balance** at all times.
18. **Do not leave machine unattended.** Wait until it comes to a complete stop before leaving the area.
19. **Perform machine maintenance and care.** Follow lubrication and accessory attachment instructions in the manual.
20. **Keep machine away from open flame.** Operating machines near pilot lights and/or open flames creates a high risk if dust is dispersed in the area. Dust particles and an ignition source may cause an explosion. Do not operate the machine in high-risk areas, including but not limited to, those mentioned above.
21. **If at any time you are experiencing** difficulties performing the intended operation, stop using the machine! Then contact our service department or ask a qualified expert how the operation should be performed.

**Extension Cord Requirements**

Amp Rating	Length And Gauge		
	25ft	50ft	100ft
0-6	#18	#16	#16
7-10	#18	#16	#14
11-12	#16	#16	#14
13-16	#14	#12	#12
17-20	#12	#12	#10
21-30	#10	#10	No

**⚠ WARNING**


Operating this equipment has the potential for flying debris to cause eye injury. Always wear safety glasses or goggles when operating equipment. Everyday glasses or reading glasses only have impact resistant lenses, they are not safety glasses. Be certain the safety glasses you wear meet the appropriate standards of the American National Standards Institute (ANSI).





# Additional Safety Instructions For Sanders

SAFETY

	<p><b>⚠️ WARNING</b></p> <p>Read and understand this entire instruction manual before using this machine. Serious personal injury may occur if safety and operational information is not understood and followed. Do not risk your safety by not reading!</p>
---	---

<p><b>⚠️ CAUTION</b></p> <p>Use this and other machinery with caution and respect and always consider safety first, as it applies to your individual working conditions. Remember, no list of safety guidelines can be complete and every shop environment is different. Failure to follow guidelines can result in serious personal injury, damage to equipment and/or poor work results.</p>
--

1. **Spindle Rotation:** Always brace workpiece against the rotation of the sanding spindle.
2. **Finger Safety:** Always keep fingertips away from the moving spindle.
3. **Sanding Rate:** Always use light pressure when holding the workpiece against the sanding spindle.
5. **Personal Safety Equipment:** Always wear ANSI-approved safety glasses, ear plugs and dust mask.
6. **Sand Safe Stock:** Always sand stock that is clean and free of defects.
7. **Sanding Sleeves:** Always replace sanding sleeves that are damaged or worn out.
8. **Develop Good Habits:** Always follow directions and safety warning to develop good habits.
9. **Air Quality:** Make sure there is good ventilation and a constant source of fresh air near the operating sander and always use a dust collector.
10. **Allergic Reactions:** The saw dust from some species of wood can be toxic to some people. Be sure to research the dangers of the specific species of wood you are sanding.



## Avoiding Potential Injuries



**Figure A.** Never sand a workpiece while holding it off the table surface.



**Figure B.** Never touch a moving spindle.

# ELECTRICAL REQUIREMENTS

## 110V Operation

The SHOP FOX® W1686 is prewired for 110 volts. The motor supplied with your new machine is rated at 1 HP and will draw approximately 14 amps. When choosing a circuit for this machine, consider using one with a 15 amp circuit breaker or fuse. Keep in mind that a circuit being used by other machines or tools at the same time will add to the electrical load being applied by the machine. Add up the load ratings of all machines on the circuit. If this number exceeds the rating of the circuit wires or circuit breaker/fuse, use a different circuit.

Verify that your current household circuit wiring is capable of handling the current load of this machine. A qualified electrician may need to install a new circuit with wiring capable of handling a 14 amperage draw. Do not attempt to modify an existing circuit by replacing the circuit breaker with one rated for a higher amperage.

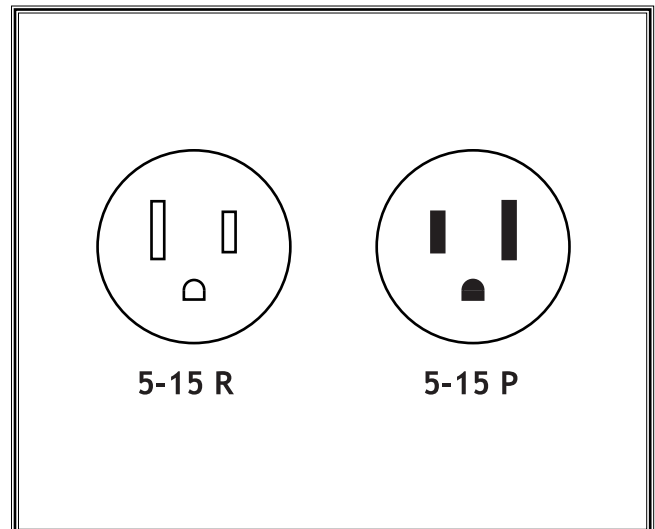
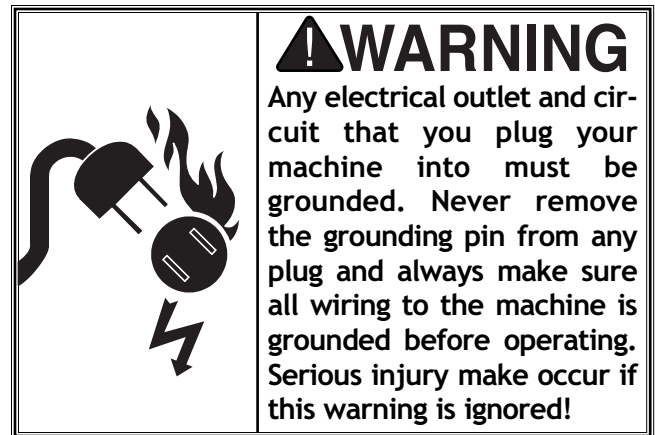
## Extension Cords

When it is necessary to use an extension cord, use the following guidelines:


- Use cords rated for Hard Service
- Never exceed a length of 100 feet
- Use cords with 14 ga. wire or bigger (12 ga., 10 ga., etc.)
- Ensure cord has a ground wire and pin
- Do not use cords in need of repair

## Grounding

This machine must be grounded! The electrical plug supplied with the Model W1686 comes with a grounding pin as shown in **Figure 1**. Do not remove it. If your receptacle does not accommodate a ground pin, have it replaced by a qualified electrician or have an appropriate adapter installed. Please note: when using an adapter, the adapter must be grounded. An adapter with a grounding wire does not guarantee the machine will be grounded. A ground source must be verified.



**Figure 1.** Typical 110V 3-prong plug and receptacle.



**! WARNING**  
 Any electrical outlet and circuit that you plug your machine into must be grounded. Never remove the grounding pin from any plug and always make sure all wiring to the machine is grounded before operating. Serious injury may occur if this warning is ignored!

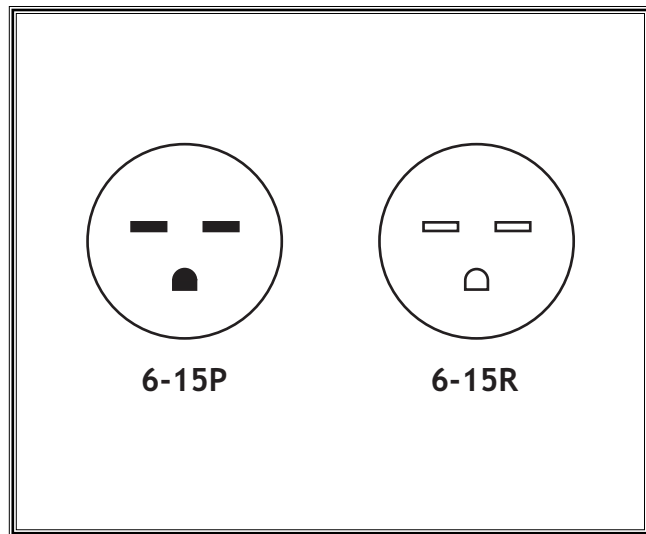


Figure 2. NEMA-style 6-15 plug and receptacle.

## NOTICE

Never replace the circuit breaker with one rated at a higher amperage or damage to the circuit may occur.

## 220V Operation

The SHOP FOX® W1686 can also be operated at 220 volts. To do this, consult with the wiring diagram in the back of this manual. Also, you will need a NEMA-style 6-15 plug and receptacle as shown in Figure 2.

The motor supplied with your new machine is rated at 1 HP and will draw approximately 7 amps during 220 volt operation. When choosing a circuit for this machine, consider using one with a 10 amp double-pole circuit breaker or fuse. Keep in mind that a circuit being used by other machines or tools at the same time will add to the total load being applied to the circuit. Add up the load ratings of all machines on the circuit. If this number exceeds the rating of the circuit wires or circuit breaker/fuse, use a different circuit.

## Extension Cords

We do not recommend using an extension cord with 220V equipment. Instead, arrange the placement of your machinery and installed wiring to eliminate the need for extension cords. If you must use an extension cord, make sure it is rated Hard Service (grade S) or better. The extension cord must always contain a ground wire and plug pin. Always repair or replace extension cords when they become worn or damaged.

## Grounding

This machine must be grounded! The electrical cord supplied with the Model W1686 does not come with a 220 volt plug. Use a plug with a ground pin as shown in Figure 2. If your receptacle does not accommodate a ground pin, have it replaced by a qualified electrician or have an appropriate adapter installed and grounded properly. An adapter with a grounding wire does not guarantee the machine will be grounded. A ground source must be verified.

# ASSEMBLY INSTRUCTIONS

## Unpacking

The Model W1686 has been carefully packaged for safe transporting. If you notice the machine has been damaged or is missing any parts, please contact Woodstock International Service and Support at 1-360-734-3482 or send e-mail to: [tech-support@woodstockint.com](mailto:tech-support@woodstockint.com).



### **WARNING**

It is absolutely critical that you read and understand this entire instruction manual before performing any operations with your machine. Serious personal injury may occur if safety and operational information is not understood and followed. Do not risk your safety by not reading!



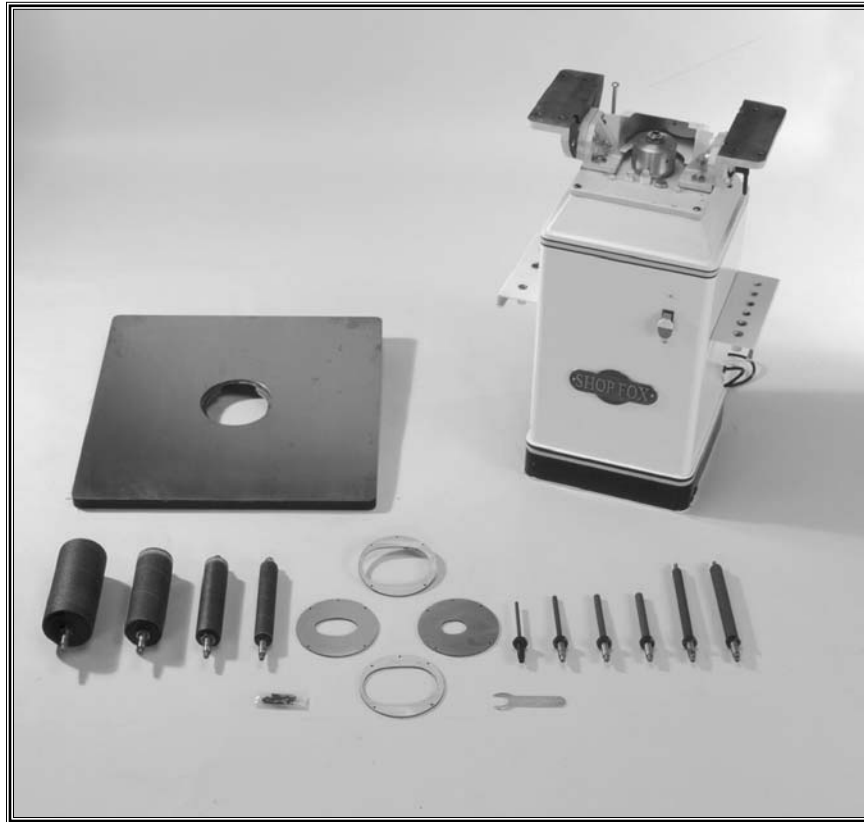
### **CAUTION**

The W1686 represents a heavy load. Seek assistance before moving into position.



### **CAUTION**

Always make sure that all entrances to your shop are locked or that machines are equipped with safety lock-out devices to protect curious children or visitors from serious injury. Never allow unsupervised people in your shop who have not been fully trained!



**Figure 3.** Component layout.

The following is a description of the components shipped with the SHOP FOX® W1688. We recommended that the components be laid out in a similar fashion to those in **Figure 3**. This will help in identification before beginning assembly. Should any parts appear to be missing, examine the packaging carefully. If any key parts are missing, call Woodstock International, Inc. at 360-734-3482 or e-mail: [tech-support@woodstockint.com](mailto:tech-support@woodstockint.com).

Item	Qty.
Spindle Sander Base	1
Spindle Sander Table	1
Sanding Spindles	10
Table Inserts	4
Spindle Wrench	1
Hardware Bag	1

# Clean Up

The exposed, unpainted surfaces of the machine have been coated with an oil to prevent rust during shipment. This oil needs to be removed before operation. Use a solvent based degreaser to remove the oil.

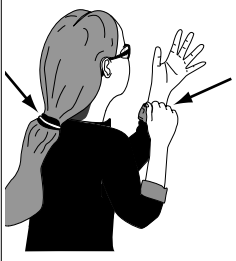
## NOTICE

Avoid using any chlorine based solutions because they will damage the painted surfaces. Always follow the instruction of the product being used.

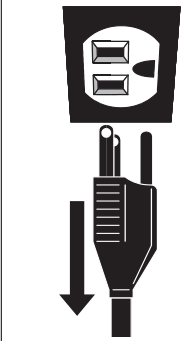
	<p><b>!WARNING</b></p> <p>Never use flammables such as gas or other petroleum-based solvents to clean your machine. These products have low flash points and present the risk of explosion and severe personal injury!</p>
--	--

	<p><b>!WARNING</b></p> <p>Never smoke while using any cleaning solvents. Smoking may cause explosion or risk of fire when exposed to these products!</p>
--	--

  	<p><b>!CAUTION</b></p> <p>Most solvents used to clean machinery are toxic when inhaled or ingested. When using these products, work in a well ventilated area and keep away from any potential ignition sources (pilot lights). Always dispose of any waste rags in a sealed container to make sure they do not cause fire or environmental hazards.</p>
----------	--



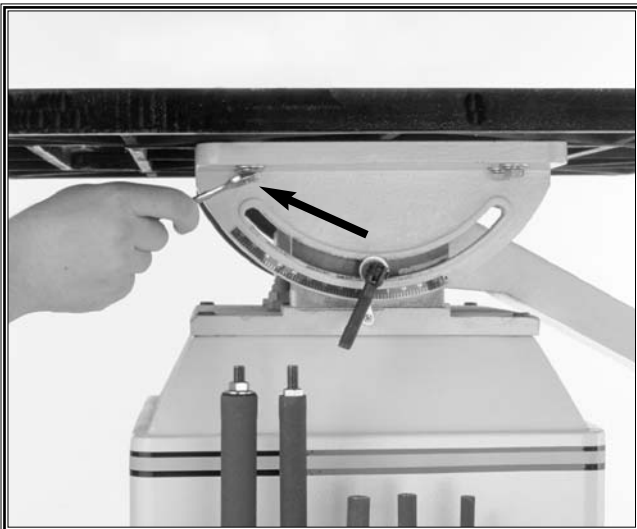
**⚠️ WARNING**  
Loose clothing and long hair must be secured and kept away from moving parts.



**⚠️ WARNING**  
Make sure that your machine remains unplugged during any adjustments or maintenance procedures. Ignoring this warning may result in serious personal injury!



**⚠️ WARNING**  
Safety glasses are absolutely required during assembly. Serious injury may occur if this warning is ignored!

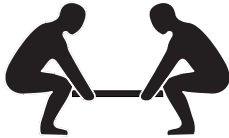


**Figure 4.** Secure the table/trunnion assembly to the sander base using the supplied hex bolts and lock washers.

## General

The main components of the SHOP FOX® W1686 are assembled at the factory; however, some assembly is required.

## Table/Trunnion



**⚠️ CAUTION**  
Get assistance before lifting the table/trunnion assembly. Personal injury can occur if assistance is not used when lifting the table/trunnion assembly.

To attach the table/trunnion assembly:

1. With the assistance of a helper, carefully lift the table/trunnion assembly onto the top of the sander base.
2. Align the mounting holes in the trunnions with the mounting holes in the sander base.
3. Using the (4)  $\frac{3}{8}$ "-16 x  $1\frac{1}{4}$ " hex bolts and (4)  $\frac{3}{8}$ " lock washers, secure the table/trunnion assembly to the sander base as shown in Figure 4.

**NOTICE**

**DO NOT** overtighten the mounting bolts as this may strip the threads from the cast iron components.


## Dust Port

Connect a dust collector to the 4" dust port on the back of the sander as shown in **Figure 5**.

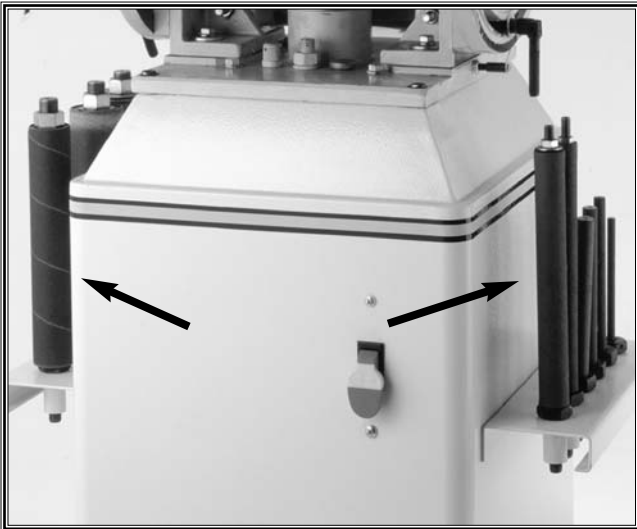
If you do not have a dust collection system, you can buy adapters to allow hook-up to a shop vacuum. Although not as adequate as a dust collector, a shop vacuum will help reduce the amount of uncontained dust and debris.



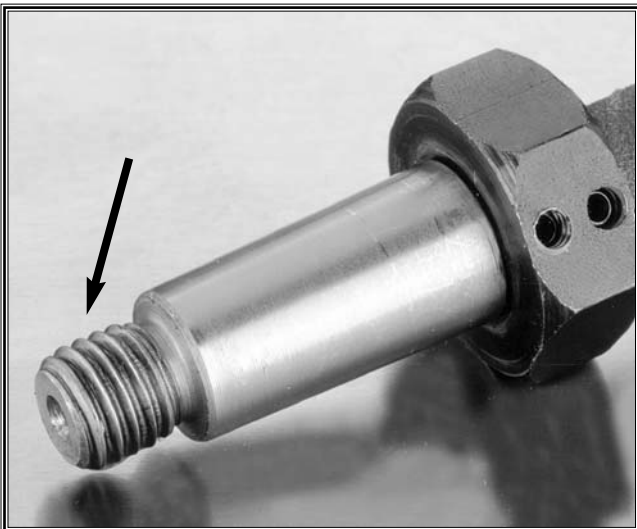
**Figure 5.** Attach a dust collection system to the 4" dust port to reduce the amount of uncontained dust.

	<p><b>⚠ CAUTION</b></p> <p>Failure to use a dust collection system can result in short and long-term respiratory illness. <b>DO NOT</b> operate the Model W1686 without an adequate dust collection system. This machine creates substantial amounts of wood dust while in operation.</p>
---	---





**Figure 6.** Spindle storage racks are located on the sides of the machine.



**Figure 7.** Lubricate the spindle shaft threads.



**Figure 8.** Use only hand pressure when tightening the spindle into the sander.

## Sanding Spindle

The Model W1686 is supplied with ten rubber sanding spindles. Use the larger diameter spindles for sanding large sweeping curves and the smaller spindles for sanding more intricate curves.

When not in use, the spindles are stored on racks located on each side of the machine base as shown in **Figure 6**. Each spindle is secured to the rack with a hex nut.

### To mount the spindle for sanding:

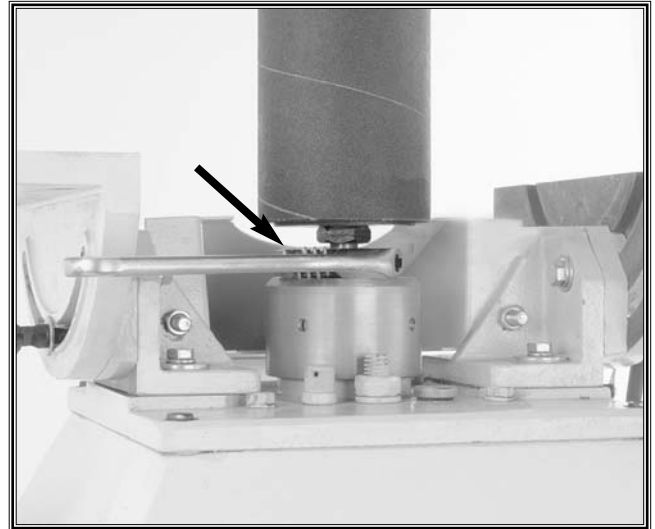
1. Determine the spindle size needed.
2. Lightly lubricate the threads shown in **Figure 7** with a light lubricant.
3. Insert the threaded end of the spindle shaft into the spindle mounting hole and screw it down by hand as shown in **Figure 8**. The spindle is now mounted and ready for action.

## NOTICE

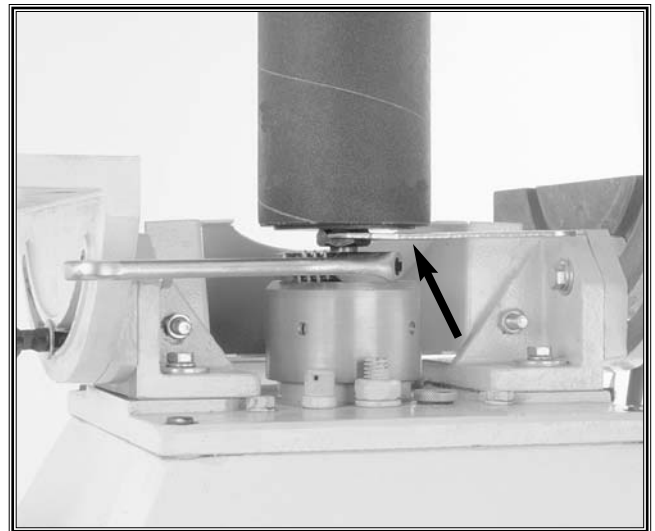
**DO NOT** tighten the sanding spindle down with a wrench! The sanding action will further tighten the spindle to the sander.

**To remove the spindle:**

1. Use an adjustable wrench to hold the jam nuts stationary as shown in **Figure 9**.
2. While holding the jam nuts stationary, use the supplied wrench to loosen the spindle retainer nut at the base of the spindle as shown in **Figure 10**.
3. Remove the spindle and return it to the storage rack.



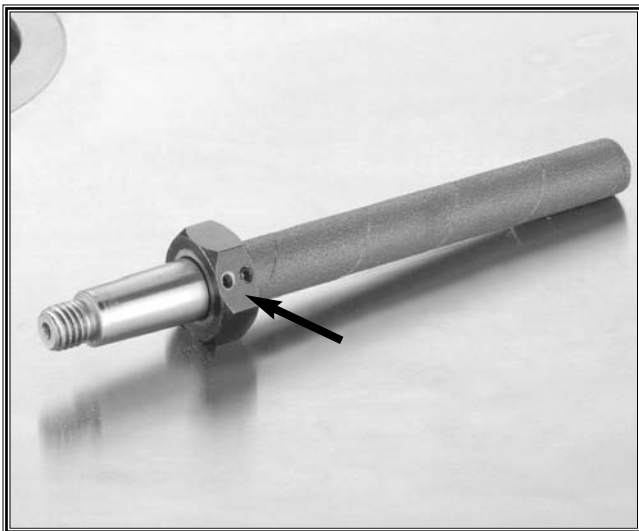
**Figure 9.** (Table removed for clarity only) Use an adjustable wrench to hold the jam nuts stationary during spindle removal.



**Figure 10.** (Table removed for clarity only) Use the supplied spindle wrench to loosen the retainer nut on the base of the spindle while holding the adjustable wrench.



**Figure 11.** To remove the sanding sleeve from the spindle, loosen the hex nut on the top of the spindle.



**Figure 12.** The four smallest spindles have small setscrews located in the retainer nut. Loosen these setscrews to remove the sanding sleeve.

## NOTICE

Monitor the wear on the sanding sleeves. Often times the upper portion of the sanding sleeve gets very little use. If this is the case, flip the sanding sleeve over and re-install. This allows maximum use of the sleeve. Worn sanding sleeves will not efficiently remove material and can burn the wood.

## Sanding Sleeve

The Model W1686 is supplied with 10 sanding sleeves. Use coarse (low #) grits for fast material removal and a rough finish. Use fine (high #) grits for slower material removal and a smoother finish. When changing from a coarse sleeve to a finer sleeve on a particular sanding project, never increase the grit number by intervals of more than 50.

### To change the sanding sleeve:

1. Loosen the hex nut located on the top of the spindle as shown in **Figure 11**. The hex nut and flange disk **DO NOT** need to be removed.

## NOTICE

Spindle sizes  $\frac{5}{8}$ " and smaller have setscrews located in the retainer nut. These setscrews hold the sanding sleeve onto the spindle as shown in **Figure 12**.

2. Slide the sanding sleeve from the spindle.
3. Reverse the above steps to install a sanding sleeve.

# Table Insert

The Model W1686 is supplied with three different sized table inserts. The inserts are designed to reduce the gap between the spindle and the table opening. The hole in each insert is oblong to allow clearance when the table is in the tilted position.

## NOTICE

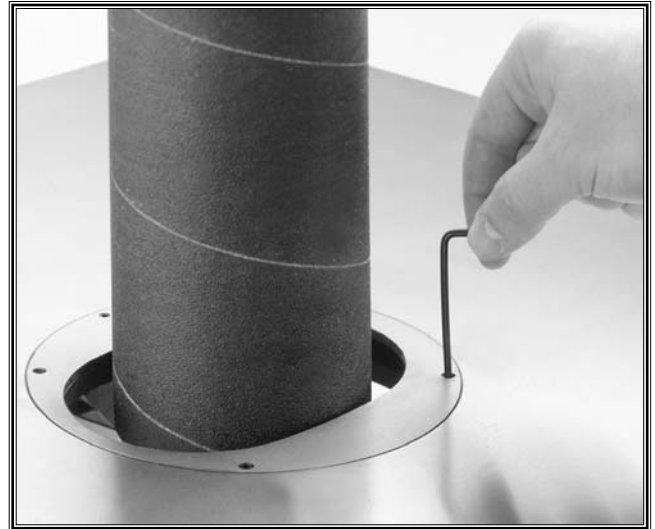
Always use the table insert with the smallest opening that still allows at least  $\frac{1}{8}$ " clearance around the spindle.

### To install the table insert:

1. Determine which table insert is best for the particular spindle you are using.
2. Install the insert over the mounted spindle and into the recessed hole on the table as shown in **Figure 13**. *The insert is fitted with pins that allow it to fit into the table in only one position. This ensures the table insert will not make contact with the spindle even when the table is tilted.*
3. Adjust the setscrews shown in **Figure 14** so the top of the insert is flush with the table surface.

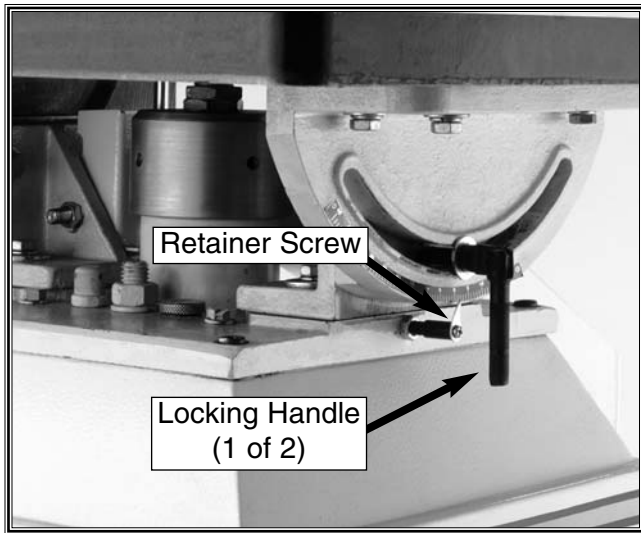


**Figure 13.** The table insert should clear the spindle by at least  $\frac{1}{8}$ " on all sides. Pins on the underside of the insert ensure correct positioning in the table.

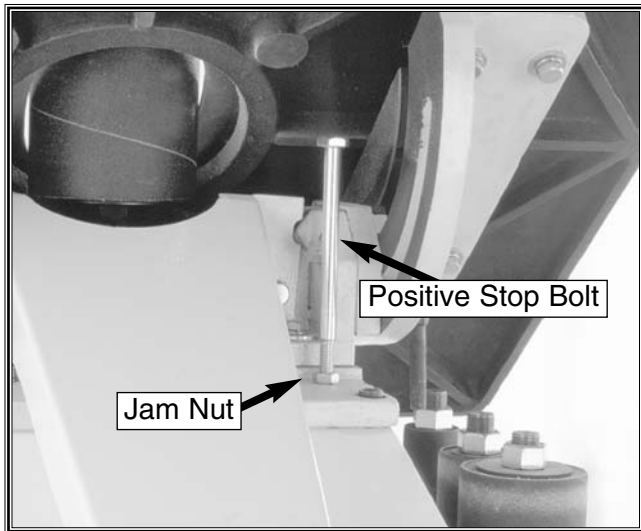


**Figure 14.** Adjust the setscrews to position the table insert flush with the table surface.

# ADJUSTMENTS



**Figure 15.** Loosen the locking handles on the trunnions.



**Figure 16.** Loosen the jam nut to allow the positive stop bolt to be adjusted.

## Positive Stop Bolt

There is a positive stop bolt located under the back right-hand side of the table. When adjusted correctly, this stop allows the table to be returned square to the spindle with speed and accuracy.

	<p><b>! WARNING</b></p> <p>Make sure that your machine remains unplugged during any adjustments or maintenance procedures. Ignoring this warning may result in serious personal injury!</p>
--	---

To adjust the positive stop bolt:

1. Loosen both locking handles (**Figure 15**) located on each side of the table trunnion assembly and tilt the table forward.
2. Loosen the jam nut and lower the head of the positive stop bolt as shown in **Figure 16**. *The positive stop bolt is located on the back left corner of the machine.*

2. Using a machinist square, bring the table surface square with the spindle surface as shown in **Figure 17**.
3. Move the square to various points around the table to ensure the table and spindle are square on all sides.
4. Lock down both handles when you are satisfied with the position of the table.
5. Loosen the retainer screw (**Figure 15**) that secures the scale pointer and adjust the scale pointer to read  $0^\circ$ . Re-tighten the retainer screw.
6. With the table square to the spindle, adjust the stop bolt until it just touches the underside of the table.
7. Retighten the jam nut to secure the positive stop bolt.



**Figure 17.** Use a machinist square to adjust the table square to the spindle.

## NOTICE

When tilting the table towards the back of the machine, the positive stop bolt must be removed completely. Be sure to recalibrate the positive stop bolt whenever it is moved or removed.

# OPERATIONS

	<p><b>! WARNING</b></p> <p>Loose clothing and long hair must be secured and kept away from moving parts.</p>
--	--

	<p><b>! CAUTION</b></p> <p>Always wear a dust mask and safety glasses in addition to using a dust collector. This machine produces sawdust that may cause allergic reactions or respiratory problems.</p>
--	---

## Test Run

Once assembly is complete, the machine is ready for a test run. The purpose of a test run is to identify any unusual noises and vibrations.

To test run the machine:

1. Turn the machine on. Be sure to have your finger poised to turn the machine off if there is a problem.
2. Once the machine is running, listen for any unusual noises. The machine should run smoothly with little or no vibrations.
3. If there are any unusual noises or vibrations, shut the machine off immediately. The machine should not be run any further until the problems are corrected.

	<p><b>! WARNING</b></p> <p>Make sure that your machine remains unplugged during any adjustments or maintenance procedures. Ignoring this warning may result in serious personal injury!</p>
--	---

4. Unplug the machine, investigate the source of the noise or vibration, and correct the source of the noise or vibration. Do not make any adjustments to the machine while it is plugged in.
5. Repeat Steps 1-4 until the machine runs smoothly.

# Standard Sanding Procedures

The Model W1686 excels at finish sanding the edges of workpieces that have been cut on a bandsaw or jigsaw (saber saw) as shown in **Figure 18**. Keep in mind that your workpiece needs to be cut larger than the desired finished size. The sander will remove a minimum of 1/16" from the edges depending on the grit used. Make a habit of cutting about 1/16" outside the desired finish line to compensate for material the sander will remove.

Always move the workpiece against the rotation of the sander. Never sand the workpiece while holding it off the table surface. This could cause the workpiece to be slammed to the table or propelled into the air.

Only a small amount of pressure is needed to effectively sand the workpiece. Avoid the temptation of pressing harder in an attempt to remove material at a faster rate. If too much pressure is applied, excessive heat may be generated causing the workpiece to burn and the sanding sleeve to wear prematurely. The best sanding results will be achieved when small amounts of material are removed in several passes. This reduces heat build up, ensures accurate results, and promotes long life from the sanding sleeves.

The best way to become familiar with the sander is to sand on scrap pieces of wood. Practice sanding inside curves and outside curves of varying size. Try different size spindles and see how the performance of the sander changes. Try using different grits on various species of wood. Now is the time to make mistakes, not when you are using expensive stock.

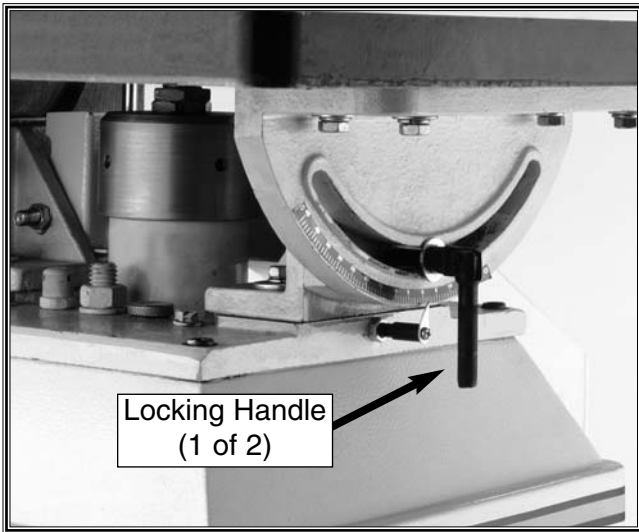


**Figure 18.** The Model W1686 is best suited for smoothing the curved cuts made by a bandsaw or jigsaw.

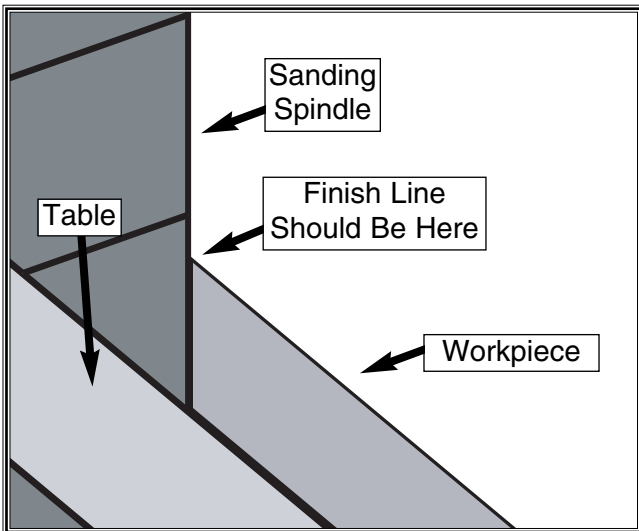
## NOTICE

Frequent cleaning can go a long way towards getting the most life from your sanding sleeves. Refer to the *Maintenance* section for complete instructions on cleaning sanding sleeves.





**Figure 19.** Use the lock handles to secure the table at the desired angle.



**Figure 20.** Mark the finish line on the longest edge of the workpiece. This allows the finish line to be viewed from the top of the workpiece.

## Bevel Sanding Procedures

### NOTICE

All of the general sanding rules that apply to standard sanding apply to bevel sanding.

### NOTICE

Bevel sanding on a spindle sander is **NOT** an exact science. When the table is tilted to  $45^\circ$ , the actual angle sanded on the edge of a workpiece will change if the workpiece is sanded at different positions around the spindle.

Adjust the table to the desired angle and secure it into position with the trunnion lock handles as shown in **Figure 19**. With the sander turned off, rotate the spindle by hand to ensure it does not make contact with the table insert.

When marking the finish line on your workpiece, always mark on the outside, or longest, edge of the bevel as shown in **Figure 20**. This allows the finish line to be viewed on the top side of the workpiece.

# MAINTENANCE

## General

Regular periodic maintenance on your Model W1686 will ensure its optimum performance. Make a habit of inspecting your machine each time you use it. Check for the following conditions and repair or replace when necessary.

1. Loose mounting bolts.
2. Worn switch.
3. Worn or damaged cords and plugs.
4. Damaged sanding sleeve.
5. Any other condition that could hamper the safe operation of this machine.

	<p><b>!WARNING</b> Loose clothing and long hair must be secured and kept away from moving parts.</p>
--	--

	<p><b>!WARNING</b> Make sure that your machine remains unplugged during any adjustments or maintenance procedures. Ignoring this warning may result in serious personal injury!</p>
--	---

## Cleaning

Because sanders produce more saw dust than most other woodworking machines, extra care must be taken to vacuum off areas that accumulate dust. If left to build up, the saw dust will work its way into the motor, bearings, and all other parts of the machine. Eventually the saw dust will begin to cause damage to the internal workings of the sander.

If any part of the sander becomes difficult to operate, it is most likely caused by an accumulation of saw dust. Immediately investigate the area and remove the saw dust.

	<p><b>!WARNING</b> Safety glasses are absolutely required during maintenance. Serious injury may occur if this warning is ignored!</p>
--	--

## Table And Base

Tables can be kept rust-free with regular applications of products like SLIPIT®. For long term storage you may want to consider products like Boeshield® T-9.

## Sanding Sleeves

As sanding sleeves are used, they will quickly become "loaded" with saw dust. If not removed, this saw dust will harden on the abrasive surface, rendering the sleeve useless. Routinely clean the sanding sleeves with a rubber gum abrasive cleaner (Figure 21) such as the PRO-STIK® cleaners available from your local Woodstock International dealer.

Always discard worn sanding sleeves. As abrasives begin to wear, grit will begin to fall off, causing deep gouges in the workpiece. Glue used to hold the grit to the paper will rub off onto the workpiece causing burns and interference with the final finishing.



Figure 21. Routinely clean sanding sleeves with a rubber abrasive cleaning stick.

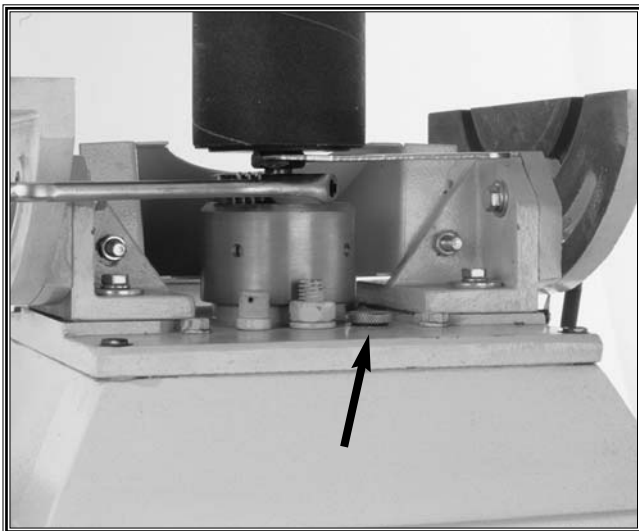


Figure 21. Routinely clean sanding sleeves with a rubber abrasive cleaning stick.

### NOTICE

Contrary to some beliefs, worn abrasives are not equivalent to the next finer grit abrasive. Discard worn sanding sleeves and avoid the temptation to sand with them beyond their usable life.

## Lubrication

The spindle gear box contains 2.8 Qts. of 90 Wt. gear oil. Replace the gear oil after approximately 1000 hours of use. Drain the gear oil from the drain plug located inside the sander base at the bottom of the gear box. The fill cap is shown in Figure 21.

Since all bearings are shielded and permanently lubricated, simply leave them alone until they need to be replaced. Do not lubricate them, as this will only attract dust and possible premature bearing failure.

DO NOT oil any exposed areas on the sander. Dust will be attracted to these areas, creating a gummy mixture that will hamper proper movement of components. Instead, lubricate exposed areas with dry powdered graphite.

# CLOSURE

The following pages contain parts diagrams/lists and a warranty card for your SHOP FOX® Model W1686.

If you need parts or help in assembling your machine, or if you need operational information, we encourage you to call our Service Department. Our trained service technicians will be glad to help you.

If you have comments dealing specifically with this manual, please write to us using the address in the General Information. The specifications, drawings, and photographs illustrated in this manual represent the Model W1686 as supplied when the manual was prepared. However, due to Woodstock International, Inc.'s policy of continuous improvement, changes may be made at any time with no obligation on the part of Woodstock International, Inc. Whenever possible, though, we send manual updates to all owners of a particular tool or machine that have registered their purchase with our warranty card. Should you receive one, add the new information to this manual and keep it for reference.


We have included some important safety measures that are essential to the operation of the machine. While most safety measures are generally universal, we remind you that each workshop is different and safety rules should be considered as they apply to your specific situation.

<p><b>⚠️ WARNING</b></p> <p>As with all power tools, there is danger associated with the Model W1686. Use the tool with respect and caution to lessen the possibility of mechanical damage or operator injury. If normal safety precautions are overlooked or ignored, injury to the operator or others in the area is likely.</p>
--

We recommend you keep this manual for complete information regarding Woodstock International, Inc.'s warranty and return policy. Should a problem arise, we recommend that you keep your proof of purchase with your manual. If you need additional technical information relating to this machine, or if you need general assistance or replacement parts, please contact the Service Department at 1-360-734-3482 or e-mail: [tech-support@woodstockint.com](mailto:tech-support@woodstockint.com).

Additional information sources are necessary to realize the full potential of this machine. Trade journals, woodworking magazines, and your local library are good places to start.

The Model W1686 is specifically designed for sanding operations. **DO NOT MODIFY AND/OR USE THIS MACHINE FOR ANY OTHER PURPOSE. MODIFICATIONS OR IMPROPER USE OF THIS TOOL WILL VOID THE WARRANTY.** If you are confused about any aspect of this machine, **DO NOT** use it until all your questions have been answered.

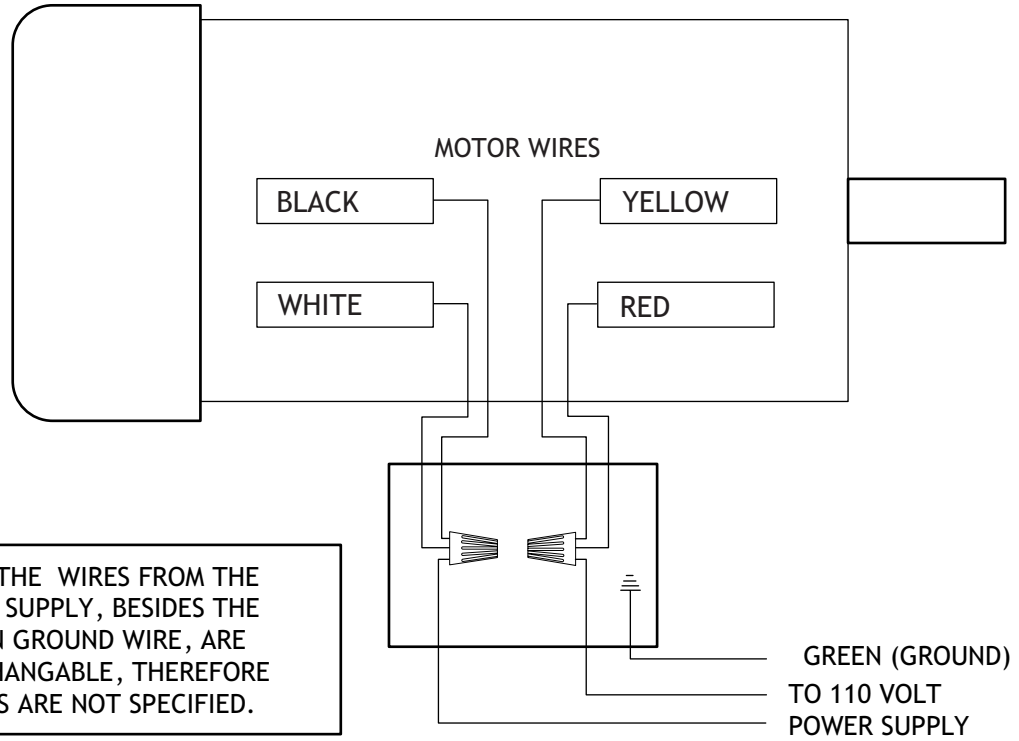
<p><b>⚠️ WARNING</b></p> <p>Operating this equipment has the potential for flying debris to cause eye injury. Always wear safety glasses or goggles when operating equipment. Everyday glasses or reading glasses only have impact resistant lenses, they are not safety glasses. Be certain the safety glasses you wear meet the appropriate standards of the American National Standards Institute (ANSI).</p>		
		

# W1686 Spindle Sander

## **! DANGER**

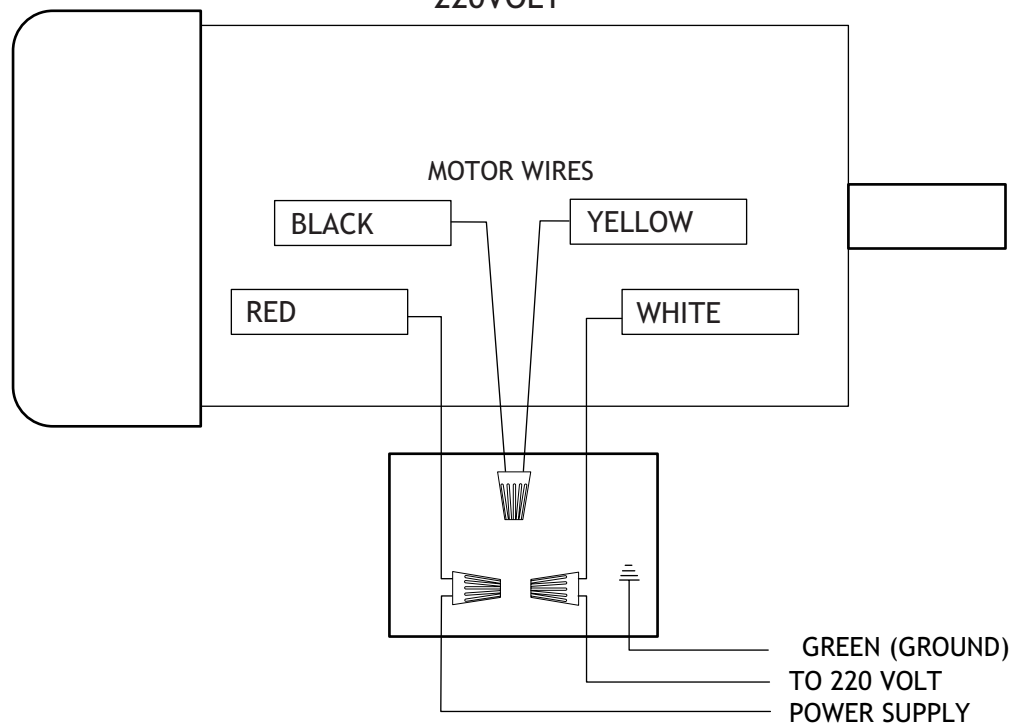
Disconnect power from machine before performing any electrical service. Failure to do this will result in a shock hazard leading to injury or death.

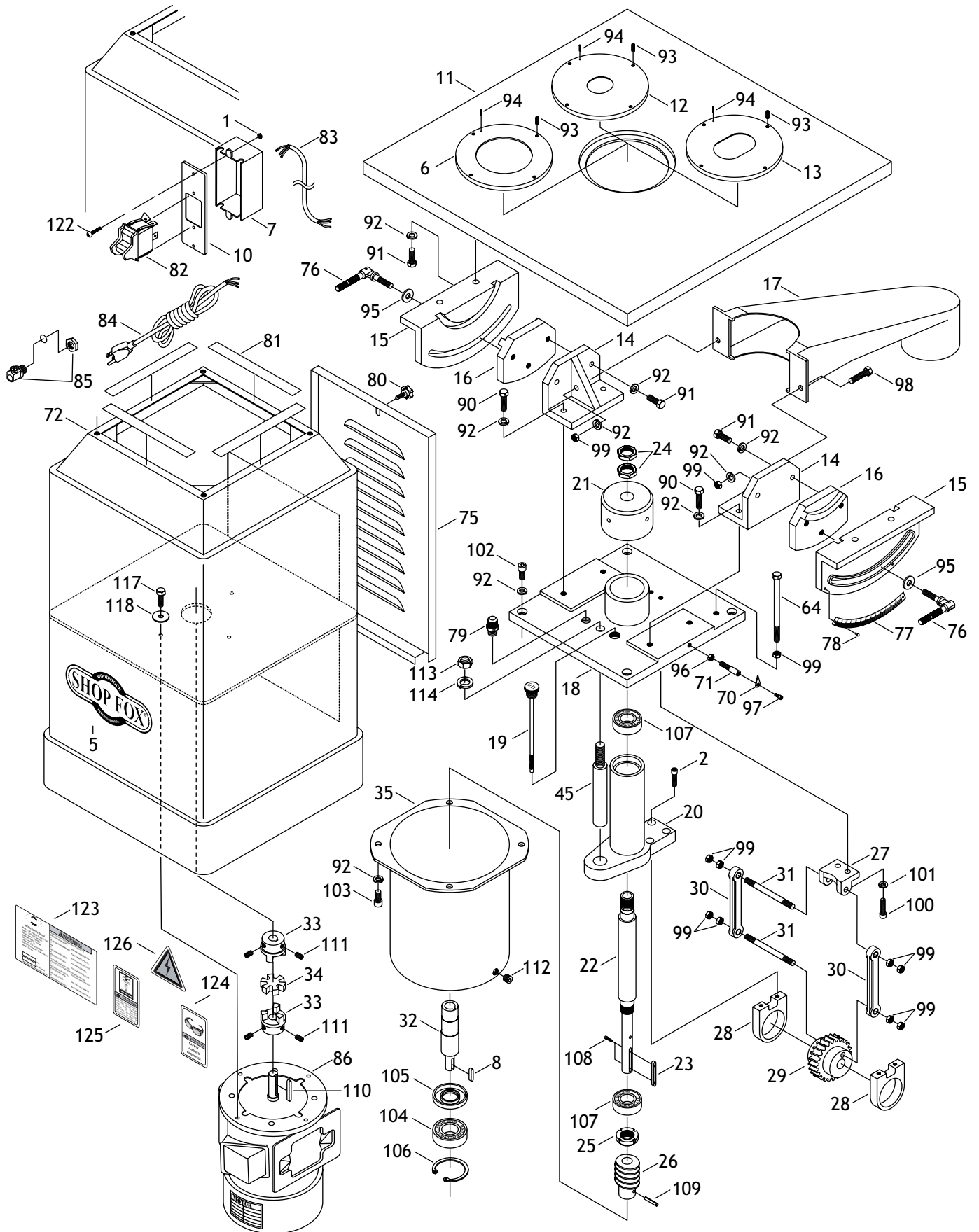
110 VOLT

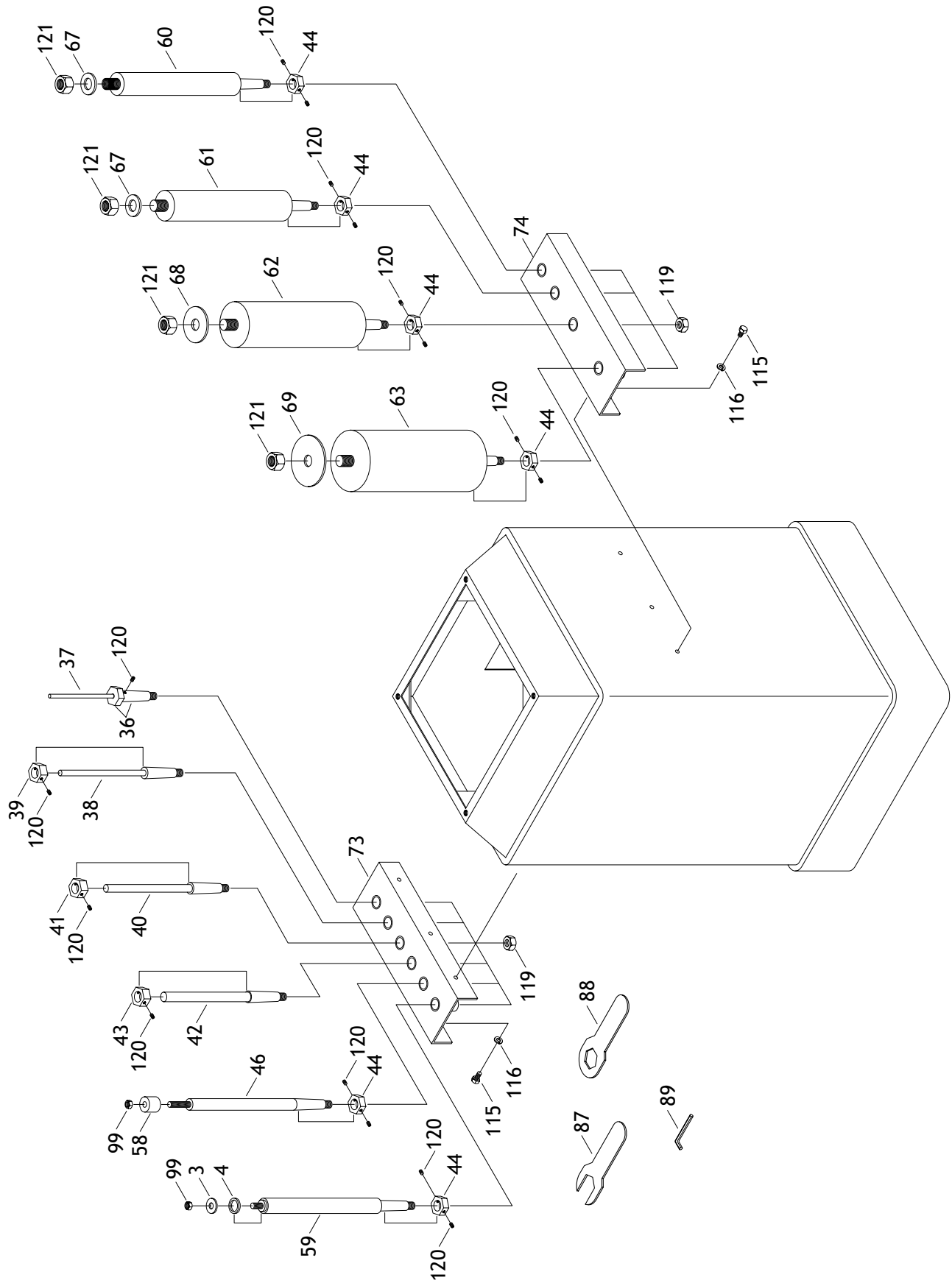


NOTE: THE WIRES FROM THE POWER SUPPLY, BESIDES THE GREEN GROUND WIRE, ARE INTERCHANGABLE, THEREFORE COLORS ARE NOT SPECIFIED.

220VOLT









REF	PART #	DESCRIPTION
001	XPNO7	HEX NUT 10-24
002	X1686002	SPECIAL CAP SCRW $\frac{5}{16}$ "-18 x 1"
003	XPW02	FLAT WASHER $\frac{3}{8}$ "
004	X1686004	SPACER
005	X1686005	NAME PLATE
006	X1686006	INSERT 4 $\frac{1}{8}$ "
007	X1686007	DUST COVER
008	XPK22M	KEY 5 x 5 x 24mm
010	X1686010	MOUNTING PLATE
011	X1686011	TABLE
012	X1686012	INSERT, $1\frac{3}{4}$ " x 2"
013	X1686013	INSERT, 2" x $3\frac{3}{8}$ "
014	X1686014	BRACKET
015	X1686015	TRUNNION
016	X1686016	INNER TRUNNION
017	X1686017	DUST HOOD
018	X1686018	HOUSING CASTING
019	X1686019	DIPSTICK
020	X1686020	SPINDLE CASTING
021	X1686021	COVER
022	X1686022	SPINDLE
023	X1686023	KEY 5 X 5 X 20MM
024	X1686024	SPINDLE RETAINER
025	X1686025	SPINDLE COLLAR
026	X1686026	WORM
027	X1686027	MOUNTING BRACKET
028	X1686028	BEARING BLOCK
029	X1686029	WORM GEAR 24T

REF	PART #	DESCRIPTION
030	X1686030	CONNECTING ROD
031	X1686031	WRIST PIN
032	X1686032	DRIVE SHAFT
033	X1686033	HUB
034	X1686034	CENTER BLOCK
035	X1686035	CASE N/S
036	X1686036	ARBOR
037	X1686037	SPINDLE $\frac{1}{4}$ "
038	X1686038	SPINDLE $\frac{3}{8}$ "
039	X1686039	RETAINER
040	X1686040	SPINDLE $\frac{1}{2}$ "
041	X1686041	RETAINER
042	X1686042	SPINDLE $\frac{5}{8}$ "
043	X1686043	RETAINER
044	X1686044	RETAINER
045	X1686045	GUIDE SHAFT
046	X1686046	SPINDLE $\frac{3}{4}$ "
058	X1686058	RUBBER GROMMET
059	X1686059	SPINDLE 1"
060	X1686060	SPINDLE $1\frac{1}{2}$ "
061	X1686061	SPINDLE 2"
062	X1686062	SPINDLE 3"
063	X1686063	SPINDLE 4"
064	X1686064	HEX BOLT $\frac{3}{8}$ " - 16 x $6\frac{1}{2}$ "
065	X1686065	GREASE FITTING
067	X1686067	FLANGE
068	X1686068	FLANGE
069	X1686069	FLANGE



REF	PART #	DESCRIPTION
070	X1686070	POINTER
071	X1686071	POINTER MOUNT
072	X1686072	CABINET
073	X1686073	SPINDLE HOLDER
074	X1686074	SPINDLE HOLDER
075	X1686075	DOOR
076	X1686076	LOCK HANDLE
077	X1686077	SCALE
078	X1686078	RIVET
079	X1686079	OIL BREATHER
080	X1686080	KNOB 1/4" - 20 X 1"
081	X1686081	GASKET
082	X1686082	SWITCH
083	X1686083	CORD, SWITCH TO MOTOR
084	X1686084	POWER CORD
085	X1686085	STRAIN RELIEF
086	X1686086	MOTOR 1 HP
087	X1686087	WRENCH 35MM
088	X1686088	SPINDLE WRENCH
089	XPAW02M	ALLEN® WRENCH 2 MM
090	XPB24	HEX BOLT 3/8" - 16 x 1 1/4"
091	XPB18	HEX BOLT 3/8" - 16 x 1"
092	XPLW04	LOCK WASHER 3/8"
093	XPSS07	SETSCREW 1/4" - 20 x 1/2"
094	XPRP42M	ROLL PIN 3 x 20mm
095	XPW02	FLAT WASHER 3/8"
096	XPNO2	HEX NUT 5/16" - 18

REF	PART #	DESCRIPTION
097	XPSB38	CAP SCREW 10 - 32 x 3/8"
098	XPB16	HEX BOLT 3/8" - 16 x 1 1/2"
099	XPNO8	HEX NUT 3/8" - 16
100	XPSB03	CAP SCREW 5/16" - 18 x 1"
101	XPLW01	LOCK WASHER 5/16"
102	XPSB16	CAP SCREW 3/8" - 16 x 3/4"
103	XPSB16	CAP SCREW 3/8" - 16 x 3/4"
104	XP6206	BEARING 6206 - 2RS
105	X1686105	SEAL 30 - 62 - 8
106	XPR38M	SNAP RING 62mm
107	XP6205	BEARING 6205 - 2RS
108	XPSB39	CAP SCREW 5 - 40 x 1/2"
109	XPRP05M	ROLL PIN 5 x 30mm
110	XPK12M	KEY 5 x 5 x 30mm
111	XPSS08	SETSCREW 5/16" - 18 x 1/2"
112	X1686112	DRAIN PLUG
113	XPNO4	HEX NUT 5/8" - 11
114	XPLW06	LOCK WASHER 5/8"
115	XPB19	HEX BOLT 1/4" - 20 x 1/2"
116	XPLW02	LOCK WASHER 1/4"
117	XPB03	HEX BOLT 5/16" - 18 x 1"
118	X1686118	5/16" FENDER WASHER
119	XPNO13	HEX NUT 1/2" - 13
120	XPSS29	SETSCREW 10 - 24 x 1/4"
121	XPNO3	HEX NUT 3/4" - 16
122	XPS03	PHLP HD SCRW 10 - 24 x 1"
123	X1686123	MACHINE ID/WARNING
124	XLABEL01	SAFETY GLASSES 2" X 3"
125	X1686125	READ MANUAL WARNING
126	X1686126	ELECTRICITY WARNING

# NOTES

# NOTES

# NOTES

# WARRANTY CARD

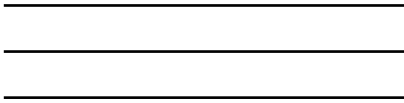
Name \_\_\_\_\_  
Street \_\_\_\_\_  
City \_\_\_\_\_ State \_\_\_\_\_ Zip \_\_\_\_\_  
Phone Number \_\_\_\_\_ E-Mail \_\_\_\_\_ FAX \_\_\_\_\_  
MODEL # \_\_\_\_\_ Serial # \_\_\_\_\_

The following information is given on a voluntary basis and is strictly confidential.

CUT ALONG DOTTED LINE

- Where did you purchase your SHOP FOX® machine?  
\_\_\_\_\_
- How did you first learn about us?  
 Advertisement  Friend  
 Mail order Catalog  Local Store  
 World Wide Web Site  
  
 Other \_\_\_\_\_
- Which of the following magazines do you subscribe to.  
 American Woodworker  Today's Homeowner  
 Cabinetmaker  Wood  
 Family Handyman  Wooden Boat  
 Fine Homebuilding  Woodshop News  
 Fine Woodworking  Woodsmith  
 Home Handyman  Woodwork  
 Journal of Light Construction  Woodworker  
 Old House Journal  Woodworker's Journal  
 Popular Mechanics  Workbench  
 Popular Science  American How-To  
 Popular Woodworking  
 Other \_\_\_\_\_
- Which of the following woodworking/remodeling shows do you watch?  
 Backyard America  The New Yankee Workshop  
 Home Time  This Old House  
 The American Woodworker  Woodwright's Shop  
 Other \_\_\_\_\_
- What is your annual household income?  
 \$20,000-\$29,999  \$60,000-\$69,999  
 \$30,000-\$39,999  \$70,000-\$79,999  
 \$40,000-\$49,999  \$80,000-\$89,999  
 \$50,000-\$59,999  \$90,000 +
- What is your age group?  
 20-29  50-59  
 30-39  60-69  
 40-49  70 +
- How long have you been a woodworker?  
 0 - 2 Years  8 - 20 Years  
 2 - 8 Years  20+ Years
- How would you rank your woodworking skills?  
 Simple  Advanced  
 Intermediate  Master Craftsman
- How many SHOP FOX® machines do you own? \_\_\_\_\_
- What stationary woodworking tools do you own? Check all that apply.  
 Air Compressor  Panel Saw  
 Band Saw  Planer  
 Drill Press  Power Feeder  
 Drum Sander  Radial Arm Saw  
 Dust Collector  Shaper  
 Horizontal Boring Machine  Spindle Sander  
 Jointer  Table Saw  
 Lathe  Vacuum Veneer Press  
 Mortiser  Wide Belt Sander  
 Other \_\_\_\_\_
- Which benchtop tools do you own? Check all that apply.  
 1" x 42" Belt Sander  6" - 8" Grinder  
 5" - 8" Drill Press  Mini Lathe  
 8" Table Saw  10" - 12" Thickness Planer  
 8" - 10" Bandsaw  Scroll Saw  
 Disc/Belt Sander  Spindle/Belt Sander  
 Mini Jointer  
 Other \_\_\_\_\_
- Which portable/hand held power tools do you own? Check all that apply.  
 Belt Sander  Orbital Sander  
 Biscuit Joiner  Palm Sander  
 Circular Saw  Portable Planer  
 Detail Sander  Saber Saw  
 Drill/Driver  Reciprocating Saw  
 Miter Saw  Router  
 Other \_\_\_\_\_
- What machines/supplies would you like to see?  
\_\_\_\_\_  
\_\_\_\_\_  
\_\_\_\_\_
- What new accessories would you like Woodstock International to carry?  
\_\_\_\_\_  
\_\_\_\_\_
- Do you think your purchase represents good value?  
 Yes  No
- Would you recommend SHOP FOX® products to a friend?  
 Yes  No
- Comments: \_\_\_\_\_  
\_\_\_\_\_  
\_\_\_\_\_  
\_\_\_\_\_  
\_\_\_\_\_

FOLD ALONG DOTTED LINE



Place  
Stamp  
Here



WOODSTOCK INTERNATIONAL, INC.  
P.O. BOX 2309  
BELLINGHAM, WA 98227-2309



FOLD ALONG DOTTED LINE

TAPE ALONG EDGES--PLEASE DO NOT STAPLE