



We create experiences

# Fugoo Bluetooth Speaker User Manual

Model FSNA1

## Contents

In the Box .....	2
Speaker controls .....	2
Charging.....	3
Checking your battery level .....	3
Charging your speaker .....	3
Turning on the speaker .....	3
Connecting .....	3
Connecting through an audio cable .....	3
Pairing and connecting with another Bluetooth device .....	4
Disconnecting from another Bluetooth device .....	4
Reconnecting .....	4
Clearing all pairings .....	4
Audio playback.....	5
Adjusting the volume.....	5
Playback .....	5
Taking a call - speakerphone mode.....	5
Taking a call.....	5
Voice Response mode.....	5
Care and maintenance.....	6
Cleaning the core .....	6
Cleaning the Style and Sport jackets .....	6
Cleaning the Tough jacket .....	6
Customization.....	6
Turning voice prompts on and off.....	6
Changing jackets.....	7
Turning voice prompts on / off .....	7
Change tones .....	7
Other functions.....	7
Resetting the speaker .....	7
Updating your software .....	8
Specifications .....	8
Optional accessories.....	10
Remote control .....	10
Bike mount .....	10
Clip .....	10
Strap.....	10
Customer support.....	10
FCC and legal notices.....	11

## In the box

- Fugoo Bluetooth Speaker, with one jacket – Style, Sport, or Tough
- AC wall charger
- Micro-USB charging cable
- 3.5 mm audio cable
- Accessory pouch
- Startup Guide
- Remote control (optional)
- Remote lanyard (included with Remote)
- Remote wrist strap (included with Remote)

## Fugoo Bluetooth Speaker controls

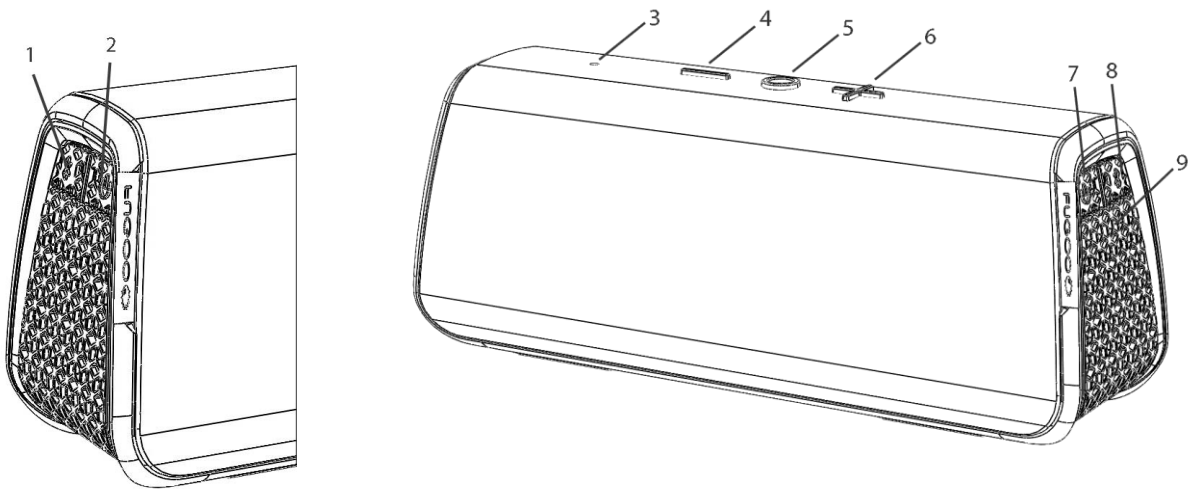

	Part	Description
1	Micro-USB charging connector / update port	For charging the speaker, and for updating its software
2	3.5 mm AUX input jack	For playing music from the headphone output of another device
3	Microphone	For speakerphone function
4	Volume down ( - )	Lowers the volume
5	Action button ( O )	Pause / Play and speakerphone control.
6	Volume up button ( + )	Raises the volume
7	Power button ( ⏻ )	Turns the speaker on / off
8	Bluetooth button ( 🔊 )	For pairing with other Bluetooth devices
9	LED indicator	Indicates status of the speaker

---

## Charging your Fugoo Bluetooth Speaker

### Checking the battery level

- Click the  (Power) button momentarily. The LED blinks one to four times to indicate the charge of the battery.
- If voice prompts are enabled, the speaker responds with "Battery is almost full." or another indication of how fully charged the battery is.

LED indicator	Voice prompt
four green blinks	Battery is almost full, or Battery is full.
three green blinks	Battery is about 3/4.
two green blinks	Battery is about 1/2.
one green blink	Battery is low.
blinking red	Please recharge the battery. Powering off.

When the speaker is charging, the LED will slowly pulse on/off green to indicate it is in charging mode.

When the speaker is charging and reached full charge the LED will be solid green to indicate full charge.



### Charging your speaker

- Connect the Micro-USB charging cable to the speaker and to the supplied AC adapter.
- Plug the AC adapter into a power outlet.
- The LED blinks green during charging.
- The LED glows steady green once the battery is fully charged, if the speaker is on.

- 
- **CAUTION:** Never use your Fugoo Bluetooth Speaker without one of its jackets (Style, Sport, or Tough). The jacket is an essential part of your speaker because it protects the speaker drivers from damage. The passive radiators, especially, could be damaged by a thumbnail, or by contact with any other relatively hard-edged object.

---

### Turning on your speaker

- Click the  (Power) button momentarily to turn the speaker on.
- When the speaker runs from battery power, it will turn itself off after 15 minutes of inactivity.
- Hold the  (Power) button for one second to turn the speaker off.

---

### Connecting your speaker to smartphones and other devices

You can connect to your Fugoo Bluetooth Speaker either through its AUX input jack or through a Bluetooth wireless link. Only one of these inputs can be active at a time.

---

## Connecting through an audio cable to the AUX input

- Connect one end of a 3.5 mm audio cable to your Fugoo Bluetooth Speaker's AUX input jack, then connect the other end to the headphones jack of your audio device.
- The LED glows blue and a voice may say, "Disconnected. Bluetooth off. Connected"
- Plugging an audio cable into the speaker's AUX input jack turns off the Bluetooth wireless link, to save power and maximize battery life.

## Pairing and connecting with another Bluetooth device

1. Make sure that a 3.5 mm audio cable is *not* connected to the speaker's AUX input.
2. Place your Fugoo Bluetooth Speaker and your other Bluetooth device within 30 feet (10 meters) of each other.
3. Turn the speaker and the other device on.
4. Hold the  (Bluetooth) button for three seconds. The LED blinks blue and red repeatedly. If voice prompts are enabled, the speaker says, "Pairing mode. Use the Bluetooth settings of your device to connect." The speaker will remain in pairing mode for three minutes.
5. On your other Bluetooth device, turn on Bluetooth, which will allow it to discover the speaker. (See the Bluetooth settings information for your device.)
6. Select 'Fugoo Speaker' on your Bluetooth device.
7. Wait briefly for the speaker to discover your Bluetooth device. If voice prompts are enabled, the speaker will say, "Pairing successful" and "Connected".  
If you hear "Pairing is unsuccessful. Please try again. Powering off.", try clearing "Fugoo Speaker" from the device's list (Select 'Forget this device' on an iPhone), and then try pairing again.

## Disconnecting from another Bluetooth device

To disconnect your Fugoo Bluetooth Speaker from another Bluetooth device, you can:

- Click the  (Bluetooth) button on your speaker.
- Move your speaker and the other Bluetooth device more than 30 feet (10 meters) apart.
- Turn off your speaker.
- Turn off the other device.
- Turn off Bluetooth on your other device.
- Disconnecting temporarily interrupts the Bluetooth wireless link between the speaker and the other devices, which permits the speaker to re-connect with another device it has been paired with. The disconnected device will still be paired with the speaker, allowing them to automatically reconnect when they are both on and within 30 feet of each other.

## Re-connecting

- To reconnect to a Bluetooth device that you have paired with, just turn on the speaker and the other device, and place them within 30 feet (10 meters) of each other. Typically, they will reconnect automatically.
- If voice prompts are enabled, the speaker says "Connected".

---

## Clearing all pairings

- To clear all of the Bluetooth pairings with other devices, turn the speaker on, and then hold the  (Bluetooth) button for eight seconds, until the speaker says "All Bluetooth pairings cleared. Pairing mode. Please use the Bluetooth settings of your device to connect."

---

## Audio playback

### Adjusting the volume

- Click the **+** (Volume up) or **-** (Volume down) buttons to raise or lower the volume.

### Playback

- Click **O** (Action) to play or pause your audio. **OR**
- Use the playback controls on your audio device to control playback.

### Navigation

- Click **O** (Action) together with the **+** and **-** buttons to skip to the next and previous track of the recording you're listening to.
- Next track: click **O** and **+**.
- Previous track: click **O** and **-**.

---

## Taking a call – Speakerphone mode

Your Fugoo Bluetooth Speaker can act as a very high quality speakerphone for your cell phone or smartphone. You can receive and end calls and manage a call on hold.

### Taking a call

If you take a call on your phone when it is connected to the speaker, you'll hear it ringing through the speaker.

- Click **O** (Action) to receive (pick up) the call.
- Talk and listen through the speaker during the call
- Click **+** or **-** to raise or lower the volume.
- Click **O** to end (hang up) the call.
- If you have a call on hold, press **O** to switch to it, and to switch back to the other call.
- Click **O** to end the active call and switch to the call on hold.
- Use your phone's controls if you would like to transfer the call back to your phone.

### Voice Response mode

- While your phone or other device is paired to the speaker (and a call is not in progress) hold **O** (Action) for one second. A tone sounds through the speaker to activate a voice response service, such as Siri or Google Now.
- Speak voice response commands through the speaker's microphone.
- Click **+** or **-** to raise or lower the volume.

---

## Care and maintenance

### Cleaning the core

- After a day at the sandy beach or the muddy trail, remove your speaker core from its jacket and rinse it off with warm water from a sink faucet. Don't use soap, detergents, or any chemical cleaning products. Don't use a garden hose, compressed air, or any other high-pressure stream to clean it, as this may damage the speaker drivers. Don't use a brush of any kind, for the same reason.

### Cleaning the Style and Sport jackets

- Remove your sandy or muddy Style or Sport jacket from the speaker core, and rinse it off with warm water from a sink faucet. Don't use a garden hose or any other high-pressure stream to clean it, as this may damage the jacket's fabric covering. Feel free to use soap or detergent, but don't use a brush of any kind, for the same reason.

### Cleaning the Tough jacket

- Remove your sandy or muddy Tough jacket from the speaker core, and rinse it off with warm water from a sink faucet, or water from a garden hose. Feel free to use soap or detergent, and a nylon or natural bristle brush to help remove debris. Never use a metal brush, which may scratch the surface of the jacket.

---

## Customization

### Turning voice prompts off / on

- With the speaker turned off, press and hold the **-** (volume down) and **+** (volume up) buttons, then also press the **⏻** (Power) button for one second. The speaker will turn on, and announce that voice prompts have been turned off or on.

---

## Changing jackets

### To remove a Style jacket

1. Turn the Fugoo Bluetooth Speaker upside down.
2. Lift up the release latch (It has a teal arrow.).
3. Slide the speaker core toward the latch, and out from the jacket.



### To add a Style jacket

1. Turn the core upside down
2. Locate the key-indentation on the bottom of the core.
3. Insert the end of speaker core with the key-indentation into the jacket, and slide it all the way in, until it snaps in place.

- **CAUTION:** Never use your Fugoo Bluetooth Speaker without one of its jackets (Style, Sport, or Tough). The jacket is an essential part of your speaker because it protects the speaker drivers from damage. The passive radiators, especially, could be damaged by a thumbnail, or by contact with any other relatively hard-edged object.

## Other functions

### Resetting the speaker

- If the speaker becomes unresponsive, or behaves differently than you believe it should, try resetting it. Hold the  (Bluetooth) and  (Action) buttons for ten seconds. This will reset the speaker's processor, without clearing its pairing list.
- The speaker can be reset whether it's on or off.

---

## Updating your Fugoo Bluetooth Speaker's software

You can change the personality of your Fugoo Bluetooth Speaker by downloading and installing a software update that contains a different set of voice prompts. Fugoo may also post new versions of the speaker software from time to time to improve its user interface and behavior.

The software updates are installed by a software update utility that is compatible with Windows 8, Windows 7, Windows Vista, Windows XP, and Mac OSX 10.5 and higher.

1. Download the software update utility from the Fugoo support website, at <http://fugoo.com/downloads> to your computer (Mac or Windows PC).
2. Connect the small end of the USB cable to your speaker, then connect the other end to a USB port on your computer.
3. Launch the software update utility.
4. Follow the on-screen instructions to update your software. The utility will tell you when the software update is finished.

---

---

## Specifications

### Audio

- Six proprietary, custom-designed acoustic drivers:
  - Two 28mm tweeters
  - Two 39mm woofers
  - Two 43mm x 54mm passive radiators
- Drivers face all directions, with an 8-degree upward tilt for better dispersion
- Sound Pressure Level (SPL-A): 95dB @ 0.5 meters
- Full Range Frequency Response: 60Hz - 20KHz
- Supports aptX® codec for high-quality Bluetooth stereo sound

### Connectivity

- Bluetooth 4.0 for wireless connectivity up to 33 feet
- Bluetooth Low Energy for remote control
- Bluetooth Audio/Video Remote Control Profile (AVRCP 1.4) enables control from your audio device and the optional Remote Control.
- Other Bluetooth Profiles: Advanced Audio Distribution Profile (A2DP) 1.3, Hands-Free Profile (HFP) 1.6, Headset Profile (HSP) 1.2
- 3.5mm stereo input for wired connection
- Micro-USB for charging and updates

### Microphone

- Omnidirectional microphone with echo cancellation
- Full-duplex capable in speakerphone mode
- Digital Signal Processor for wind and background noise reduction

### Power

- Up to 40 hours continuous play at 50% volume
- Built-in Lithium-Ion rechargeable battery
- Charged via USB or international AC Adapter (included)
- Battery life displayed on supported devices



---

## Environmental

- Operating Temp: 14° - 131° F (-10° - 55° C)
- Storage Temp: -40° - 158° F (-40° - 70° C)
- IP67 Rated: Dustproof and waterproof to 1 meter for 30 minutes

## Size & Weight

### With Style jacket

- 2.1" x 6.5" x 2.6" (54 x 165 x 66mm)
- .97 lbs (442g)

### With Sport jacket

- 2.3" x 7.4" x 2.9" (59 x 187 x 73mm)
- 1.1 lbs (519g)

### With Tough jacket

- 2.3" x 7.75" x 2.9" (59 x 197 x 73mm)
- 1.4 lbs (624g)

---

## Optional accessories

**Fugoo Style Jacket**



**Fugoo Sport Jacket**



**Fugoo Tough Jacket**



**Remote Control**



**Bike Mount**



**Multi Mount**



**Strap Mount**



**Accessory Pack**



For more information, visit Fugoo's [Accessories](#) webpage.

## Remote Control

Please see the separate **Fugoo Remote Control User Manual**.

## Product support

- Visit Fugoo's Support page at [support.fugoo.com](http://support.fugoo.com) for help with connecting, to view our FAQs, or to ask us a question.
- Visit Fugoo's downloads page at [fugoo.com/downloads](http://fugoo.com/downloads), for software updates, alternative voice prompts, and mobile wallpaper images,

- 
- Send us a support request at <mailto:support@fugoo.com>.

---

## Legal notices

### FCC Statement

This equipment has been tested and found to comply with the limits for a Class B digital device, pursuant to part 15 of the FCC Rules. These limits are designed to provide reasonable protection against harmful interference in a residential installation. This equipment generates uses and can radiate radio frequency energy and, if not installed and used in accordance with the instructions, may cause harmful interference to radio communications. However, there is no guarantee that interference will not occur in a particular installation. If this equipment does cause harmful interference to radio or television reception, which can be determined by turning the equipment off and on, the user is encouraged to try to correct the interference by one or more of the following measures:

- Reorient or relocate the receiving antenna.
- Increase the separation between the equipment and receiver.
- Connect the equipment into an outlet on a circuit different from that to which the receiver is connected.
- Consult the dealer or an experienced radio/TV technician for help.

This device complies with FCC radiation exposure limits set forth for an uncontrolled environment.

This device complies with Part 15 of the FCC Rules. Operation is subject to the following two conditions: (1) this device may not cause harmful interference, and (2) this device must accept any interference received, including interference that may cause undesired operation.

### Caution!

Any changes or modifications not expressly approved by the party responsible for compliance could void the user's authority to operate the equipment.

### IC Statement

This device complies with Industry Canada licence-exempt RSS standard(s).

Operation is subject to the following two conditions: (1) this device may not cause interference, and (2) this device must accept any interference, including interference that may cause undesired operation of the device.

Le présent appareil est conforme aux CNR d'Industrie Canada applicables aux appareils radio exempts de licence. L'exploitation est autorisée aux deux conditions suivantes : (1) l'appareil ne doit pas produire de brouillage, et (2) l'utilisateur de l'appareil doit accepter tout brouillage radioélectrique subi, même si le brouillage est susceptible d'en compromettre le fonctionnement.

The device meets the exemption from the routine evaluation limits in section 2.5 of RSS 102 and compliance with RSS-102 RF exposure, users can obtain Canadian information on RF exposure and compliance.

Le dispositif rencontre l'exemption des limites courantes d'évaluation dans la section 2.5 de RSS 102 et la conformité à l'exposition de RSS-102 rf, utilisateurs peut obtenir l'information canadienne sur l'exposition et la conformité de rf.

### COFETEL

La operación de este equipo está sujeta a las siguientes dos condiciones: (1) es posible que este equipo o dispositivo no cause interferencia perjudicial y (2) este equipo o dispositivo debe aceptar cualquier interferencia, incluyendo la que pueda causar su operación no deseada.