

Keyboard Controller Users Manual

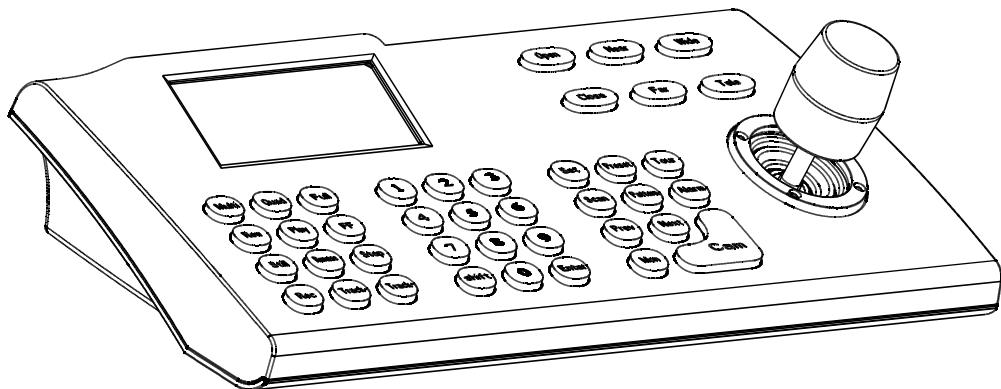

CATALOGUE

1. Summary-----	1
1.1 Notice-----	1
1.2 Function and Characteristic-----	1
1.3 Technical Data-----	1
2. Keyboard Connection-----	2
2.1 Keyboard Interface Instruction-----	2
2.1.1 Rs422 and Rs485-----	2
2.1.2 Power Supply Port-----	2
2.1.3 Rs232 EIA Interface-----	2
2.1.4 RJ45 Interface-----	2
2.2 DIP Switches Setting-----	3
2.3 Matrix Connection-----	3
2.3.1 RJ45 Local Connection-----	3
2.3.2 RS422 Remote Connection-----	3
2.4 Connect with The Dome Directly-----	4
2.5 Connect DVR-----	4
2.6 The Connection of The Keyboard in The System-----	4
3. Keyboard operation manual-----	6
3.1 Current-carrying to keyboard-----	6
3.2 LCD-----	6
3.3 Joystick controls dome -----	6
3.4 Change object dome-----	7
3.5 Control dome lens-----	7
3.6 Set dome function-----	7
3.6.1 Preset-----	7
3.6.2 Scan-----	7
3.6.3 Pattern-----	8
3.6.4 Tour-----	8
3.7 Call dome main menu-----	8
3.8 Control matrix-----	8
3.8.1 Switch dome in order-----	8
3.8.2 Call matrix main menu-----	8
3.8.3 Confirm after program-----	8
3.8.4 Change object monitor-----	8
4. Keyboard control-----	9
4.1 keyboard index setting-----	9
4.1.1 Set ID number-----	9
4.1.2 Set the baud rate-----	9
4.1.3 Set password-----	9
4.1.4 Joystick calibration-----	10
4.1.5 Multi keyboard state-----	11
4.2 Dome setup-----	11
4.2.1 Set dome preset-----	11
4.2.2 Set dome scan -----	11
4.2.3 Set dome pattern -----	12
4.2.4 Set dome tour-----	12

4.3 Alarm box control-----	13
4.3.1 Set the alarm input channel status and the alarm spot-----	13
4.3.2 Set alarm ON/OFF status and alarm reset time -----	13
4.3.3 Manually reset alarm input-----	14
4.3.4 Resume the factory default setting-----	14
4.4 Protocol setting-----	14
4.4.1 Pelco matrix model-----	14
4.4.2 Directly control model-----	14
4.4.3 DVR control model-----	15
4.5 Keyboard information display-----	15
4.6 Exit keyboard menu-----	15
5.Appendix-----	16
5.1 Rs485 Bus Basic Knowledge-----	16
5.2 Keyboard shortcut operation manual-----	17
6.Keyboard Menu Index-----	18
7.Maintenance service terms-----	19

1. Summary

The keyboard is an universal keyboard of security monitoring series, which can control integrate dome camera with all kinds of protocols matrix and DVR , which has been equipped with 3D joystick which can control the revolving of the camera and the zoom magnification of lens; with the LCD screen and the function of back-light; which can display the current operation order, the control protocol name, the current dome ID, the current monitor ID and the state of joysticks. The user can control the CCTV system more easily with the joystick and the LCD screen .



1.1 Notice

- Please read the manual carefully and reserve it.
- Please advert to the notice in manual.
- Please don't place the keyboard in the moist place.
- Please don't close up the keyboard to exothermic object for long time.

1.2 Function and Characteristic

- Rs485 Bus Line, and a keyboard can connect 31 domes at most in the direct control mode.
- It can be compatible with all kinds of protocols.
- You can control the Iris 、 Locus and Zoom.
- You can set and call the preset, run scan、 pattern and tour.
- You can control the matrix and through which can control the dome indirectly.
- It can be set alarm trigger ans alarm linkage.
- It has been equipped with the 3D joystick and the larger LCD screen.

1.3 Technical Data

- ◆ Electrical
Input voltage: 9V-12V AC/DC
Rated power: 2.5W
- ◆ Communication
Communication interface:
RS485×1, RS422×1,RS232×1,RJ45
Communication frequency:
2400Bps ,4800Bps, 9600Bps
Communication distance:
1.2km (RS485 and Rs422 can achieve it)
- ◆ Operational environment
Operating temperature: 0℃ ~40℃
Relative humidity: less than 90%
- ◆ Physical property
L*W*H=378*160*98 (mm)
Weight: 1.3kg (Net Weight)

2. Keyboard Connection

2.1 Keyboard Interface Instruction

There is interface on the back of the keyboard, which equipped with kinds of communication interfaces:RS232、RS422、RS485、RJ45,which can connect and control kinds of peripheral equipment.

2.1.1 RS422 and RS485 interface

Rs422 and Rs485 interface are on the 6bit ribbon cable connection of the keyboard.RS485 (A+ B-) can connect with the dome when the keyboard controls the dome directly;RS485 (A+, B-) can connect with DVR or other keyboards when the keyboard controls the dome by matrix; RS422 (T + ,T -) is sending the signal ,RS422(R + ,R -) is receiving the signal , both of which can connect with matrix, DVR and so on.

2.1.2 Power supply port

It can be used to connect with the 9V-12V DC/AC power. The keyboard is equipped with the transformer which can convert AC230V to DC9V.

2.1.3 RS232 EIA Interface

It can be used to expand the function to control the menu handler, DVR, PC and so on.

2.1.4 RJ45 Interface

It is the standard network interface which can be mainly used for connecting with the matrix for short distance(the distance is less than 7.6m). About the details, Please see to “2.3 matrix connection” .

2. 2 DIP Switch Setting

In keyboard there is 8-bit DIP switch the 1-7 bit is invalid, the 8-bit is the end resistance (120Ω) setting of Rs485 Industry Bus Line. It means the end resistance has connected into the Rs485(A+,B-)Bus line when the setting is “ON” .See to “5.1 RS485 Bus Line Knowledge” .

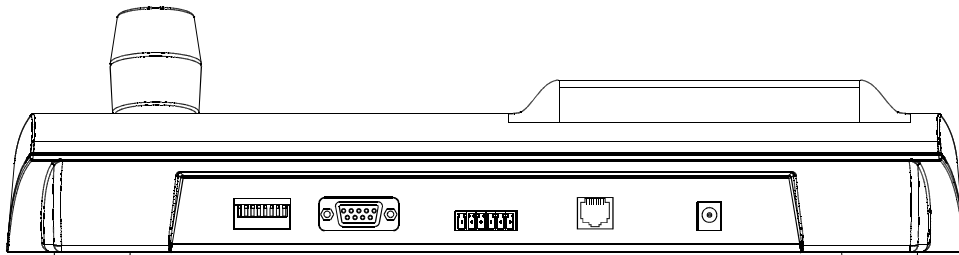

Picture 2-1.1

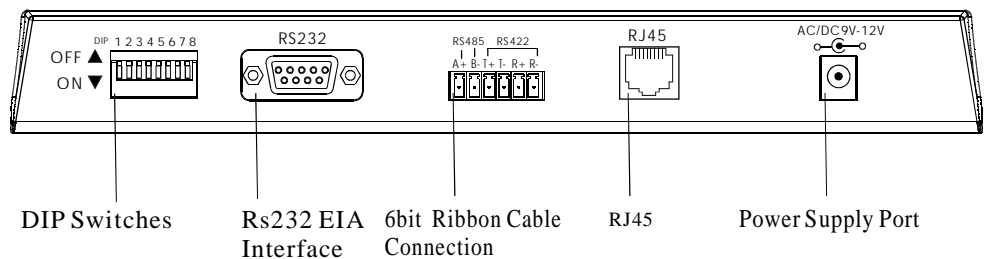

Picture 2-1.2

2.3 Matrix Connection

The keyboard can control matrix of PELCO CM6700、CM6800. Take example below that the keyboard connects with the PELCO CM6700 matrix in order to introduce the connection between the keyboard and the matrix.

There are two kinds of keyboard connection interface on the CM6700 matrix back plate: one is local keyboard connection interface RJ45 ("LOCAL KEYBOARD"), which can control the single keyboard with the distance of 7.6m; The other is the remote interface RS422 ("REMOTE KEYBOARD(S)"), which can connect with the keyboard RS422 interface, the maximum distance is 1200m.

2.3.1 RJ45 Local Connection

Please insert one crystal end of RJ45 connection line into the RJ45 interface of the keyboard, and insert the other one into the RJ45 interface ("LOCAL KEYBOARD") of CM6700 matrix.



NOTICE

- 1、RJ45 local connection, the distance between the keyboard and the matrix is less than 7.6m.
- 2、RJ45 interface is with the power of 12VAC, And the keyboard which is connected with CM6700 matrix doesn't need the other power.

2.3.2 Rs422 remote connection

Rs422 connection line, one end connects with Rs422 interface (REMOTE KEYBOARD(S)) of 6700cm back plate, the other end connects with Rs422 interface of the keyboard, the keyboard interface Rs422 (R+ R-) corresponds with matrix interface Rs422 (T+ T-) , the keyboard interface Rs422 (T+ T-) corresponds with matrix interface Rs422 (R+ R-) .



NOTICE

- Rs422 remote connection, the maximum distance between the keyboard and the matrix is 1200m.

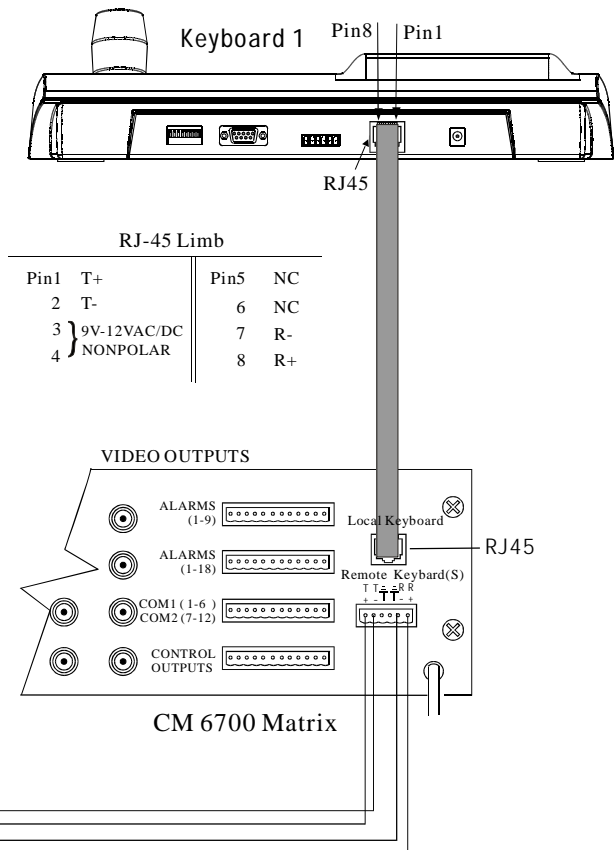
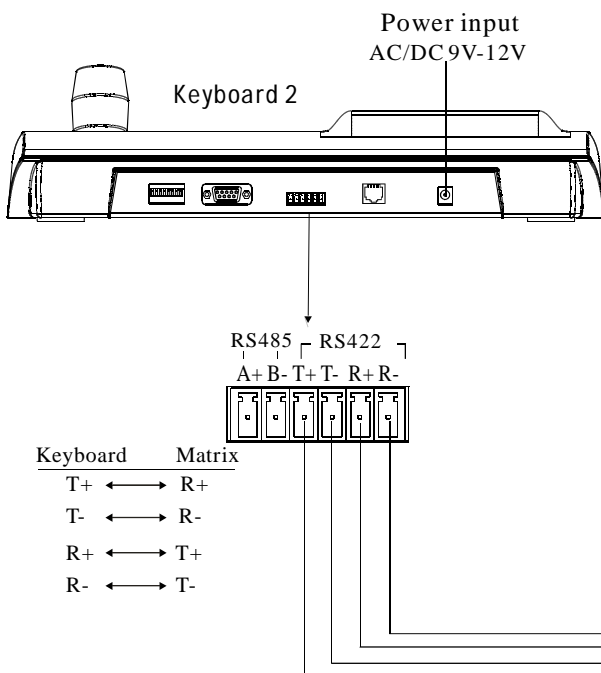

Picture 2-3.1

2.4 Connect with The Dome Directly

You can connect with the dome by Rs485 interface when the keyboard controls the dome directly. The Rs 485 interface of the dome is on the switchboard of pendent hanger of the upper cover of the dome. You can find the 4Pin control/power socket and find the corresponding Rs485 (A+, B-) interface according to the above mark when you turn the metal button inside the hanger and open the switchboard.

There are different connection ways according to the domes which produce by the different manufacturers. About connection with the dome, please see to the dome installation manual.

2.5 Connect DVR

The keyboard can connect DVR and dome by Rs 422 interface, the keyboard Rs422 (R+, R-) Can separately connect DVR Rs485 (A+, B-) Rs (T+, T-) and dome Rs485 (A+, B-)

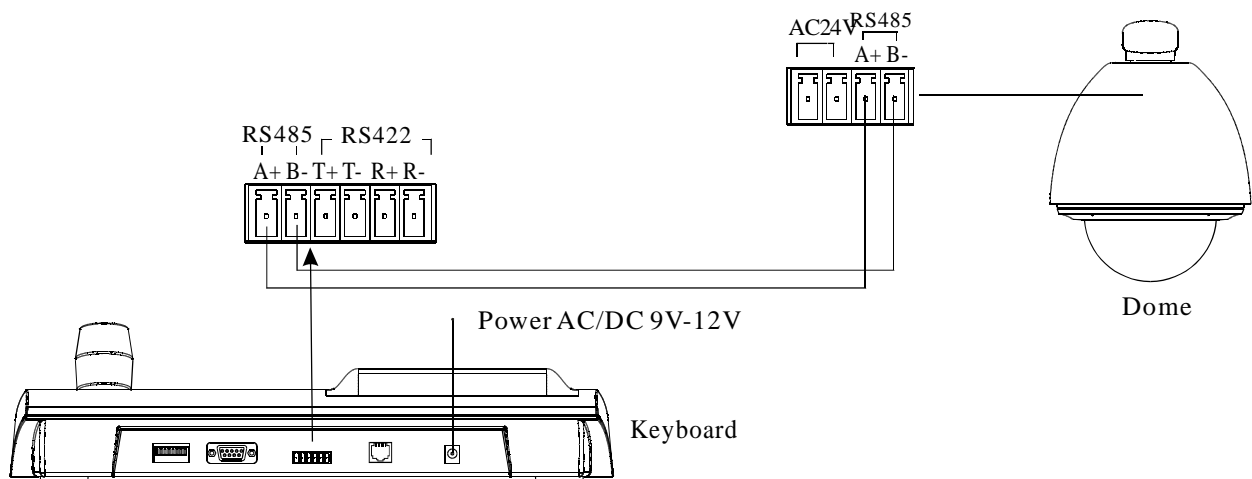

Picture 2-4.1

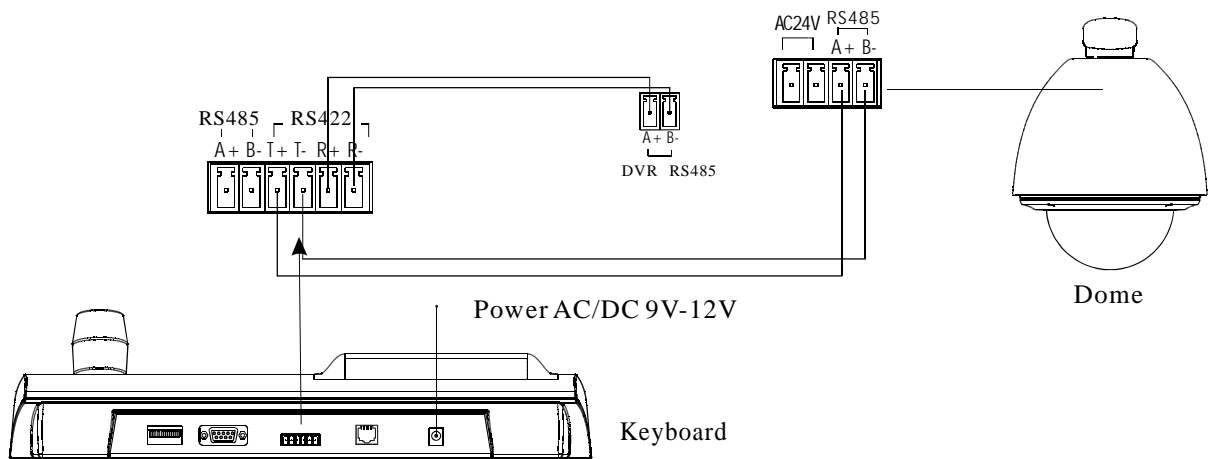

Picture 2-5.1

2. 6 The Connection of The Keyboard in The System

Keyboard controls the alarm box, and connects the dome by the alarm box. The details please see to the alarm box user manual. Every alarm box only can connect one camera.

The keyboard controls the matrix, then controls the domes indirectly by the matrix (sees to the picture2-6.1) .When unconnect with the matrix, the keyboard controls the dome directly.

Keyboard controls computer (DVR) and dome etc. (Sees to the picture2-6.2) when unconnect with DVR, the keyboard controls the dome directly Keyboard and camera may control each dome by parallel connect to Rs485 Bus and each keyboard may control each dome. This way is required to have a main keyboard(the main keyboard ID set as 1), the Baud rate of keyboard is set as 9600bps.(sees to the picture 2-6.3)

As the previous picture shows, keyboard and keyboard connection or keyboard and computer connection set as Rs232, when their distance is more than 20m, suggest that set it as Rs485.

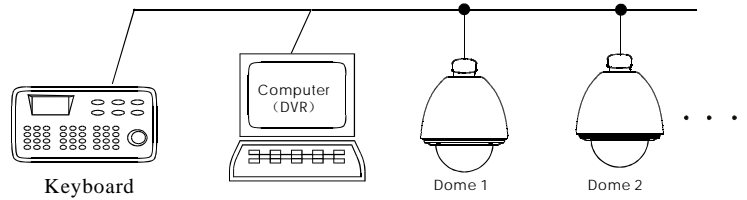

Picture 2-6.2

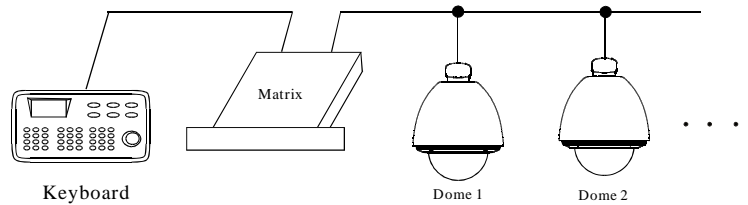

Picture 2-6.1



1. A line of Rs485 may control up to 32 main controlling and under controlling equipments, so a keyboard which controls the dome directly may connect up to 31 domes.
2. The system may connect up to 4 keyboards at the same time, and the four keyboards ID are different.

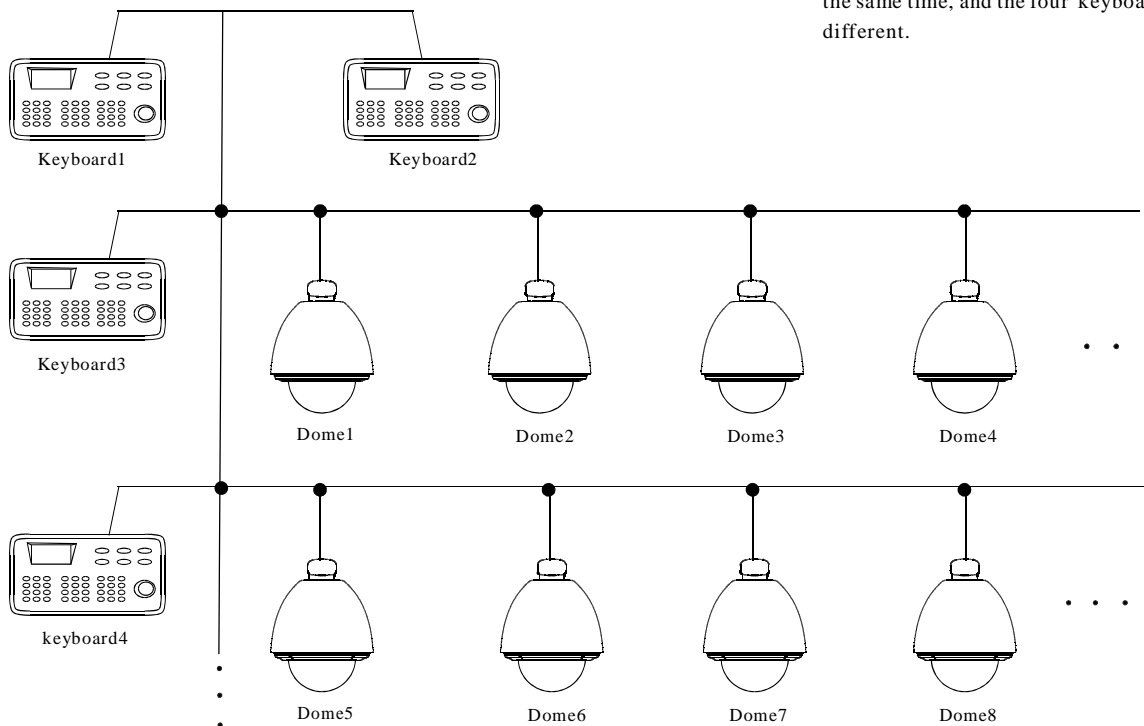

Picture 2-6.3

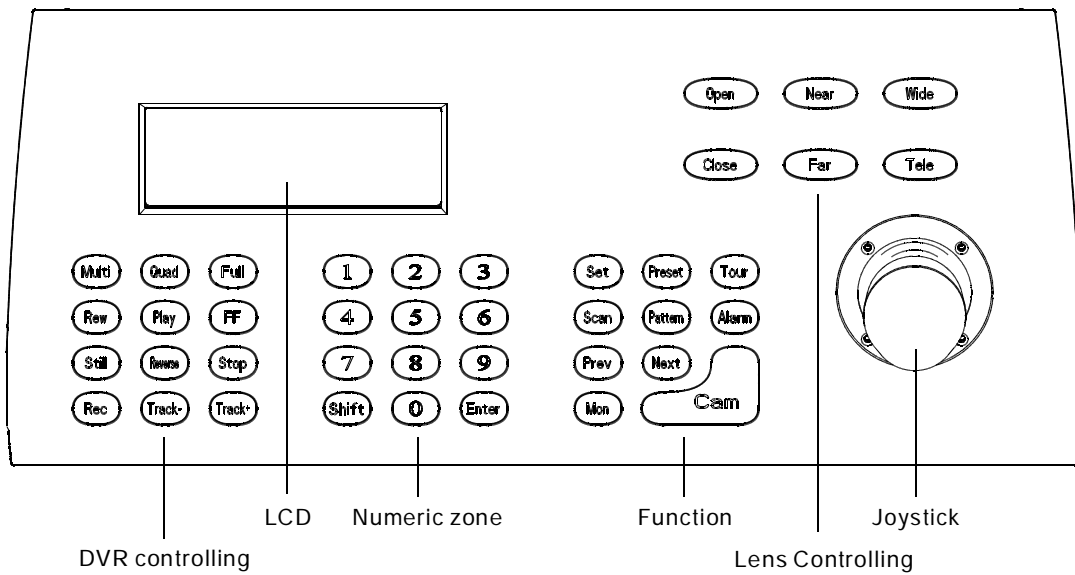

Picture 3-1.1

3. Keyboard Operation Manual

This passage mainly describes the operation ways of keyboard, it needs to especially explain that different systematic platform has not the same operations, and different systematic platform may have some particular requirements and operations, please operate it to combine with the operation manual of dome and matrix.

3.1 Current-carrying to keyboard

When electricity to keyboard, the keyboard will auto-test the version number, keyboard ID, baud rate, protocol, and object dome and object monitor will auto-set as 1, and these information will display in the LCD.



NOTICE

1. when the keyboard is initializing, should be make the joystick to return to 0, not to pull or tilt the joystick.

3.2 LCD

LCD display is used to list the basic information of keyboard operation, which involves keyboard model, keyboard ID, controlling camera, monitor ID, baud rate and so on. In the last line there are keyboard input commands and joystick operation. As the right picture shows: When operating it, LCD will turn on back light, in order to operate easily; stop to operate it for 15s, back light will be off automatically.

Keyboard V1.02	
Keyboard ID:	001
Camera ID:	002
Monitor ID:	001
Protocol:	Pelco Matrix
Baud rate:	9600bps

Picture 3-1.2

3.3 Joystick controls the dome

Joystick has two functions, one is manually controlling dome rotation, the other is setting controlled object menu.

- Tilt joystick at any directions, the dome will rotate in correspondence with directions, at the same time , LCD displays the information as lower right corner shows "3 4 5 6", they respectively reflects tilt up, tilt down, tilt right, tilt left. If the joystick tilts upper right corner, the screen will display such information " 5 4 " The joystick return to the primary location, and the dome immediately stop to rotate.
- The joystick tilt up means choosing previous menu, which is down means choosing next menu if it is used to set the menu; the joystick is right means entering the next menu or reserving setting after set, which is left means exit or stop reserving.
- The more heavy is the gradient of joystick, the more fast speed the dome rotates. By control the gradient of joystick, to control the rotation speed of dome.
- Rotate the joystick cap may adjust the focus of lens, to rotate in clockwise, the camera lens is Tele, at the same time there is "□" displays in the LCD; the camera rotates in counter clock wise, the lens is wide, at the same time there is "□" displays in the LCD.

3.4 Change object dome

【N】 + 【Cam】

【N】 reflects numeric key(Do not explain it again), input the dome ID, Press **【Cam】** to change object dome.

3.5 Dome lens control

∅ Zoom control:

Press **【TELE】** ,lens zoom tele (the multiple of lens increase), leave to stop.

Press **【WIDE】** , lens zoom wide (the multiple of lens reduction), leave to stop.

User may control the zoom by rotating joystick.

∅ Focus control:

Press **【FAR】** manually far focus, to make the far object more legible, leave to stop.

Press **【NEAR】** manually near focus, to make the near object more legible, leave to stop.

In usual situation, the camera is in the status of auto focus, user may operate manual focus to run other operations by the two keys, and the camera will automatically resume to auto-focus.

∅ Iris control:

Press **【OPEN】** manual Iris increase, Iris is max, the screen will show white, leave to stop.

Press **【CLOSE】** manual Iris reduction, Iris is min, the screen will show black, leave to stop.

3.6 Dome function operation

3.6.1 Preset

● Set preset: **【SET】 + 【N】 + 【Preset】**

● Call preset: **【N】 + 【Preset】**
【N】 reflects preset number.

3.6.2 Scan

● Set left limit: **【SET】 + 【1】 + 【Scan】**

● Set right limit: **【SET】 + 【2】 + 【Scan】**

● Run scan: **【1】 + 【Scan】**

If change the speed of scan, should enter into menu setup.

3.6.3 Pattern

● Set pattern path: **【SET】 + 【N】 + 【PATTERN】**
 +Path+ **【SET】 + 【0】 + 【PATTERN】**

Press **【SET】** , input pattern NO. (1-4) ,

press **【PATTERN】** to enter tour setup, the dome records a series of motions, when end up, press **【SET】** , then press **【0】** ,then press **【PATTERN】** , the pattern setup is finished.

● run pattern: **【N】 + 【PATTERN】** Input pattern number (1-4) , press **【PATTERN】** , run pattern.

3.6.4 Tour

Run tour: **【N】 + 【TOUR】 / 【TOUR】**

Press tour number, press **【TOUR】** , run tour.

If system has only a tour, press **【TOUR】** directly.

Set tour must enter menu setup.

3.7 Call the dome main menu

【9】 + 【5】 + 【Preset】 : input 95, then press **【Preset】** to call the main menu of object dome, and the menu is displayed in the object monitor. About how to set the dome menu by keyboard,

Please refer to the dome Operation manual.

3.8 Control the matrix

3.8.1 Switch the domes in order

The matrix connects sixteen domes, and switches the dome to previous and next dome.

【PREV】 : switch to previous dome. Press **【PREV】** , switch to previous dome in single step; Press **【PREV】** to hold it for 2s, and jump sixteen domes of the connection matrix in previous order. Press **【Stop】** to stop to switch.

【NEXT】 : switch to next dome. Press **【NEXT】** to switch the next dome in single step; press **【NEXT】** to hold it for 2s, and jump the sixteen domes of the connection matrix.

【Stop】 : switch continuously, press **【Stop】** to stop to switch.

3.8.2 Call main menu of matrix

【Shift】 + 【Set】 : call the main menu, and the menu will be displayed in the object monitor. How to set the matrix menu by keyboard? Please refer to the matrix operation manual.

3.8.3 Confirm after program

【ENTER】 : after the matrix is programmed, press **【ENTER】** , reflects confirm after program, as for the detail program, please refer to the matrix operation manual.

3.8.4 Change object monitor

【N】 + 【MON】

Input the monitor ID, then press **【MON】** , the image and the menu of the dome that you controlled by keyboard will display in the object monitor.



NOTICE

As the keyboard is working in Pelco matrix mode (refer to 2.2 DIP switches setting), the keyboard can directly control the dome or the monitor by matrix. just work under pelco matrix mode, may carry out the command of controlling matrix.

4、 The Keyboard Menu Controlling

Ø The keyboard menu controlling

Press **【Set】** ,keep 2 seconds; Got the main menu, the LCD display is following bellow.(See the picture 4.1-1)all menu setup should call main menu.

Press numerical key or move the joystick up and down after entering the main menu, which can enter the relevant menu setting.

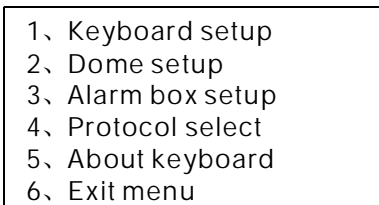

Picture 4.1-1

Ø Saving Setting

Choose relevant numerical keys in according to the menu hint, then can enter relevant function setting; Press **【Enter】** and reserve; LCD will display “success” after finishing the setting successfully.

Ø Returning previous menu

Press **【Prev】** ,or move the joystick leftwards, then return the previous menu.

4.1 Keyboard ID Setting

4.1.1 Set keyboard ID

1. Enter main menu

LCD display(See to picture 4.1.1-1)

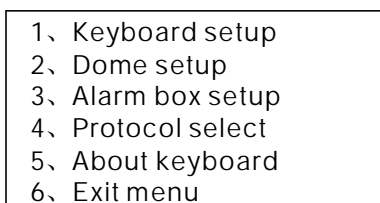

Picture 4.1.1-1

2. Press **【1】** then choose keyboard setting

LCD display (See to the picture 4.1.1-2)

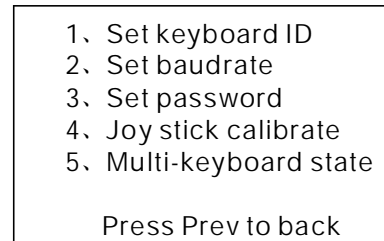

Picture 4.1.1-2

3. Press **【1】** to choose keyboard ID setting

LCD display (Sees to the picture 4.1.1-3)

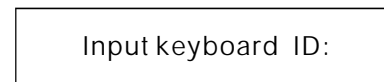

Picture 4.1.1-3

Press the relative numerical key (1-64) ; press enter **【 Enter 】** to confirm. The screen display (See to picture 4.1.1-4), which means operating successfully.

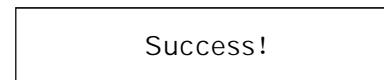

Picture 4.1.1-4

The screen will show **【 Error 】** if putting the numerical key which are excess the ID scope (1-64) (Sees to picture 4.1.1-5)

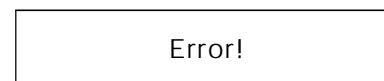

Picture 4.1.1-5

4. Press **【PREV】** or move the joystick leftwards then go back gradually

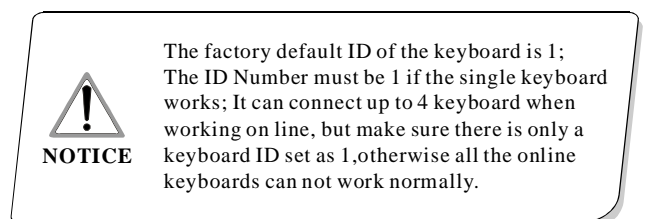

4.1.2 The keyboard baud rate setting

Enter menu (LCD display sees to the picture 4.1.1-1)

Press **【1】** to set the keyboard

LCD display (sees to the picture4.1.1-2)

Press **【2】** to set the keyboard baud rate.

LCD Display (Sees to the picture 4.1.2-1)

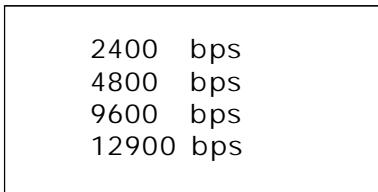

Picture 4.1.2-1

Press the relevant numerical keys; or move the keyboard up and down to choose the baud rate, then press Enter. The screen display (sees to the picture 4.2-4) It means the operation is success. Then Press **【Prev】** or move the joystick leftwards to go back.

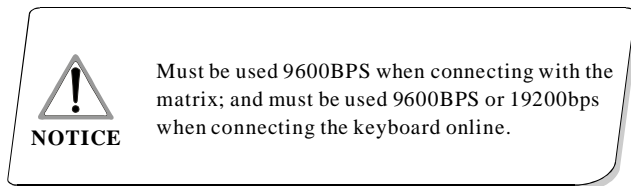

4.1.3 Set password

Enter OSD menu, LCD will display as Picture (4.1.1-1) shows:

Press **【1】** to choose keyboard setting, LCD will display as Picture 4.1.1-2 shows.

Press **【3】** to choose password setting, LCD will display as Picture 4.1.3-1 shows.

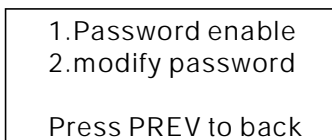

Picture 4.1.3-1

Press **【1】** to choose ON and OFF of password setting, as choosing 1, LCD will show "SUCCESS", it means entering OSD menu need to input password; as choosing 2, LCD will show " SUCCESS", it means entering OSD menu no need password. (As picture 4.1.3-2 shows)



Picture 4.1.3-2

Press **【2】** to choose "Modify password". LCD will display as picture 4.1.3-3 shows

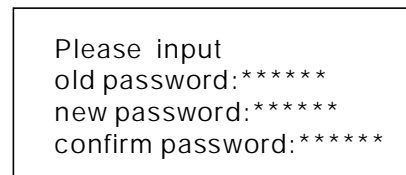

Picture4.1.3-3

Firstly input the old password " 892226", press "ENTER", the cursor will jump to the second row, then input the new password, press "ENTER", the cursor will jump to the third row, confirm your new password again, press "ENTER", LCD will show "SUCCESS",and back to the menu.

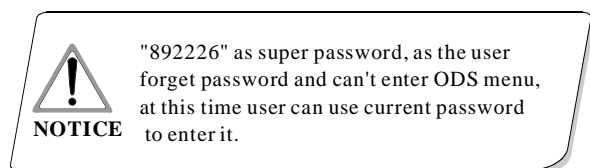

4.1.4 Joystick Calibration

Enter the main menu.

LCD display.(sees to the picture 4.1.1-1)

Press **【1】** To choose the keyboard setting.

LCD setting. (sees to the picture 4.1.1-2)

Press **【3】** to enter Joystick Calibration.

LCD display (sees to the picture 4.1.3-1)

Joystick is free then
Press Enter

Picture 4.1.3-1

Press **【 Enter 】** then finish the operation
The screen display (see to the picture 4.1.3-2)

Success!

Picture 4.1.3-2

NOTICE As joystick calibration, make sure the joystick be on natural status.

4.1.5 Multi-keyboard Connection state setting

Enter into OSD menu, LCD will display as Picture 4.1.1-1 shows.

Press **【1】** to set the keyboard.

LCD will display as Picture 4.1.1-2 shows.

Press **【4】** to set multi-keyboard connection state setting. After you select **【Multi keyboard state】**, tilt up/down the joystick to set the state as [ON] or [OFF], the default setting of keyboard is OFF, as it set as ON, it can support multi-keyboard work, there is non-interference between them, one group can support 4pcs keyboard mostly, as Multi-keyboard state is opened, if there is only a keyboard to work, the keyboard address must be set as 1, or the keyboard can't be controlled.

NOTICE In multi-keyboard state the baud rate of each keyboard should be set as 9600bps.

4.2 Dome function setting

Entering OSD menu, press **【2】** to enter dome function setting. As picture 4.2-1 shows

1、 Set dome preset
2、 Set dome scan
3、 Set dome pattern
4、 Set dome tour

press PREV to back

Picture 4.2.1

4.2.1 Preset

Press **【1】** to choose preset, LCD will display as Picture 4.2.1-1 shows.

1、 Save preset
2、 Show preset
3、 Clear preset

press PREV to back

Picture 4.2.1-1

Press **【1】** to save preset: by operating joystick and adjusting magnification to choose objective image, then choose **【1】** to save preset, input preset Number (1-128), you can set 128 preset at most. LCD will display as Picture 4.2.1-2 shows.

1.Preset num:
(1-128)

Press PREV to back

Picture 4.2.1-2

Press **【2】** to show preset: input current preset NO., then show current preset. As picture 4.2.1-2 shows, Press **【3】** to clear preset: input current preset No., then clear the current preset. As picture 4.2.1-1. Press **【PREV】** to back.

4.2.2 Scan

Press **【2】** to choose scan, LCD will display as Picture 4.2.2-1 shows.

1、 set left limit
2、 set right limit
3、 run scan

Press PREV to back

Picture 4.2.2-1

Press **【1】** to set the left limit of scan: Operating the joystick to choose objective image, press **【ENTER】** to confirm. LCD will show " SUCCESS"
, LCD will display as Picture 4.2.2-2 shows.

Press ENTER sure

Press PREV to back

Picture 4.2.2-2

As the above method, press **【2】** to set the right limit of scan.

Press **【3】** to run current scan (in keyboard only can set 1 scan). Press **【PREV】** to back

4.2.3 Pattern

Press **【3】** to choose pattern, LCD will display as Picture 4.2.3-1 shows.

1. pattern num:
2. set pattern
3. run pattern

Press PREV to back

Picture 4.2.3-1

Press **【1】** to input pattern No. (1-4), by keyboard can set 4 patterns at most.

Press **【2】** to program current pattern, randomly moving image and zoom in/out. The dome will record park time, magnification, focus and a series of actions, press **【1】** to start record, press "0" to stop record, LCD will display as Picture 4.3.2-2 shows.

Press 1 to start
Press 0 to stop

Press PREV to back

Picture 4.2.3-1

Press **【3】** , the dome will continuously repeat the appoint tour that you record. Press **【PREV】** to back.

4.2.4 Tour

Press **【4】** to choose tour setting, LCD will display as Picture 4.2.4-1 shows.

1. tour num:
2. insert preset
3. run tour

Press PREV to back

Picture 4.2.4-1

Press **【1】** to input tour No. (1-6), by keyboard can set 6 tours at most.

Press **【2】** to set preset, speed and preset park time of tour. LCD will display as Picture 4.2.4-2 shows.

1. Preset num:
2. Speed
3. Dwell

Press PREV to back

Picture 4.2.4-2

Press **【1】** to input preset No. (1-80), press **【ENTER】** to confirm, the cursor jumps the second row, then input the speed (1-8) of current preset, press **【ENTER】** to confirm, the cursor jumps the third row, to input the park time (1-60s) of current preset, press **【ENTER】** to confirm, LCD will show "SUCCESS". LCD will display again as picture 4.2.4-2 shows, can continuously set 6 tours. Press **【PREV】** to back.
Press **【3】** to run tour. As picture 4.2.4-1 shows.

4. 3 The alarm box control

Ø The operation of the keyboard controlling the alarm box:

- It can be set of the alarm signal input state of the alarm input channel and of the preset number of the channel.
- It can be set if the alarm input channel will respond the alarm input.
- It can be set that the alarm input channel are restoration mode (Manual or Auto)and the auto-restore time.
- It can be restored of the manual restoration alarm channel.
- The keyboard still can control the camera by the alarm box. The function of the camera will be no influencing, but the objective camera ID will be determined by the DIP switch setting of the alarm control box.

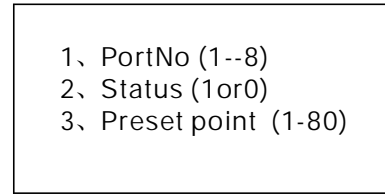

Picture 4.3.1-3

Input corresponding channel number(1-8)(“0” means operation for all channels), press Enter, when the cursor jumps to the second row, to in-put port status that need to be set (1: ON; 0: OFF), press **【Enter】**, when the cursor jumps to the third row, to input the preset point that the alarm will turn to(“0” means operation for all presets), press **【Enter】**, the screen will display the above prompt again, it requires to set other channels, you may press **【Prev】** to back the previous menu.

4. 3. 1 The alarm input channel state setting and the alarm spot

1. Enter the menu

LCD display (sees to the picture4.3.1-1)

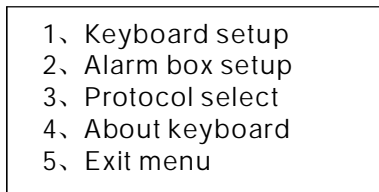

Picture 4.3.1-1

2. Press **【2】** to choose the alarm setting

LCD display(sees to the picture 4.3.1-2)

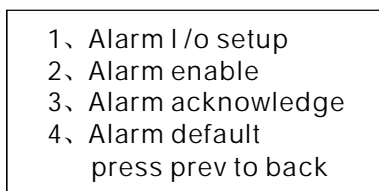

Picture 4.3.1-2

3. Press **【1】** to set the alarm input channel state and spot

LCD display (sees to picture 4.3.1-3)

4.3.2 Set alarm ON/OFF status and alarm reset time

Enter into the menu,LCD display (sees to the picture4.3.1-2)

Press **【2】** to select alarm box setup

Press **【2】** to select the alarm setting status and alarm reset time.

LCD display (sees to the picture 4.3.2-1)

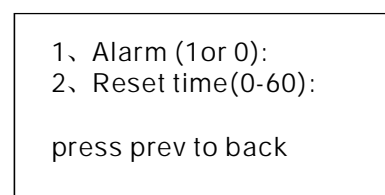

Picture 4.3.2-1

At this moment, press **【1】** to open alarm function, press “0” to close alarm function, press **【Enter】**, the cursor jumps to the second row, to input the reset time that need to modify, its numerical value switches at 0-60, if you select “0” the alarm box need to reset manually.

Press **【Prev】** or move the joystick leftwards to go back.

4.3.3 Manually reset alarm input

Enter into the menu
LCD display (sees to the picture4.3.1-2)
Press **【2】** to select the alarm box setup
LCD display (sees to the pictures4.3.3-1)
Press **【3】** to select manually reset alarm input channel

Input the relevant channel number (1-8) then press **【Enter】** to reserve.

Press **【Prev】** or move the joystick leftwards to go back.

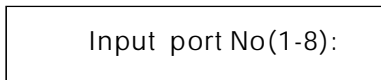

Input port No(1-8):

Picture 4.3.3-1

4.3.4 Resume the factory default setting

Enter the main menu
LCD display (sees to the picture 4.3.1-2)
Press **【2】** to select the alarm box setting
Press **【4】** to resume the factory default state

LCD display (sees to the picture 4.3.3-2)

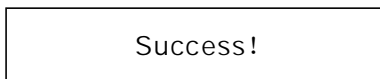

Success!

Picture 4.3.3-2

And return automatically, carry out the function. The parameter of the alarm box will resume into the state before leaving the factory, will eliminate all settings. Please use the function carefully!

4.4 Protocol Setting

Enter the menu
The screen (sees to the picture4.2.1-1)
Press **【3】** to enter the protocol setting

LCD display(sees to the picture 4.4-1)

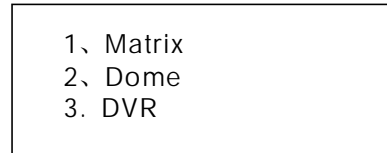

1、 Matrix
2、 Dome
3. DVR

Picture 4.4-1

4.4.1 Pel co matrix mode

Press **【1】** to enter the PELCO matrix mode
LCD display (sees to the picture 4.4.1-1)
Press **【Enter】** and choose the protocol then return

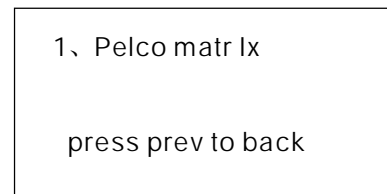

1、 Pelco matr lx

press prev to back

Picture 4.4.1-1

4.4.2 Directly control model

Press **【2】** to enter the direct control mode
LCD display (sees to the picture 4.4.2-1)

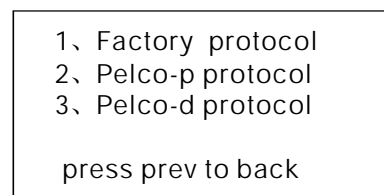

1、 Factory protocol
2、 Pelco-p protocol
3、 Pelco-d protocol

press prev to back

Picture 4.4.2-1

Press the relevant numerical key to select the relevant protocol, then go back to the previous menu.

4.4.3 DVR control model

Enter the protocol setting option menu, as picture(4.4-1), press 3 choose the DVR control model ,as picture:(4.4.1-1),

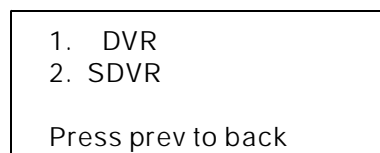

1. DVR
2. SDVR

Press prev to back

Picture 4.4.3-1

Inside it contain two different protocols which are Common DVR and special DVR (SDVR), according to the customers use different DVR model can choose different protocol, press Enter or move the joystick right side to choose the correspond number to right protocol, the screen will display Success to show protocol set successfully.

After you set DVR control protocol, press PREV to quit the keyboard control menu, on the LCD screen, after the Protocol, it will display the DVR control protocol (DVR or SDVR), when keyboard working under the SDVR control protocol, if customers need to control the dome during the process of the control the DVR. Only press Shift bottom, then can conveniently switch the model between DVR and Keyboard directly control the dome. When switch to dome directly control model, the Protocol item on LCD screen will show protocol of keyboard and dome, and ID address switch between Camera ID DVR ID, Through PREV NEXT to choose the operation DVR and Dome ID, press PREV mean the ID number reduce 1, Press NEXT mean the ID number plus 1. When choose right protocol, Baud rate and ID number, then keyboard can control the DVR.



NOTICE

1. When it is DVR control model, the baud rate must be set 9600Bps.
2. All path of DVR should set protocol Pelco D4, baud rate should be 9600bps, then it can communicate with dome, if you want to control dome by SDVR.

4.5 Keyboard message display

Enter the main menu

Press **【4】** to check the keyboard message

LCD display (sees to the picture 4.5-1)

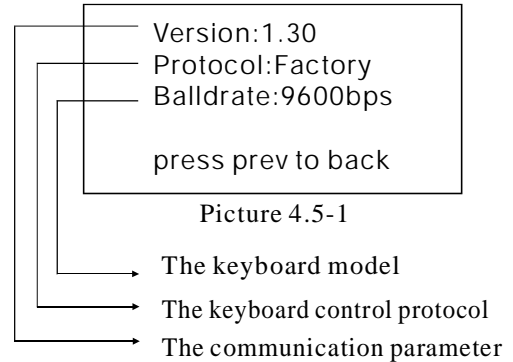

Press **【Prev】** or move the joystick leftwards to return. The keyboard message menu will display the keyboard parameter setting, the keyboard model, the Keyboard protocol and the keyboard baud rate.

4.6 Exit the keyboard menu

Enter the menu

The LCD display (sees to the picture4.2.1-11)

Press **【5】** and exit the menu directly

5.1 RS485 Bus Basic Knowledge

Ø Characteristic of RS485 Bus line

As specified by RS485 standards, RS485 Bus is of half-duplexed data transmission cables with characteristic impedance as $120\ \Omega$. The maximum load capacity is 32 unit loads (including main controller and controller equipment)

Ø Transmission distance of RS485 Bus line

When user selects the 0.56mm (24AWG) twisted pair wires as data transmission cable, the maximum theoretical transmitting distances are as follows:

If user selects thinner cables, or installs the dome in an environment with strong electromagnetic interference, or connects lots of equipment to the RS485 Bus, the maximum transmitting distance will be decreased. To increase the maximum transmitting distance, do the contrary.

Baud Rate	Maximum Distance
2400bps	1800m
4800bps	1200m
9600bps	800m
19200bps	600m

Ø Connection and terminal resistance

The Rs485 standards require a daisy-chain connection between the equipment. There must be termination resistance with $120\ \Omega$ impedance at both ends of the connection (refer to picture 4-1.1).

Please refer to picture 4-1.2 for simple connection. And “D” should not exceed 7m.

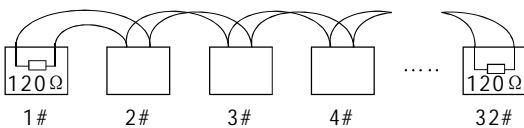

Picture 4-1.1

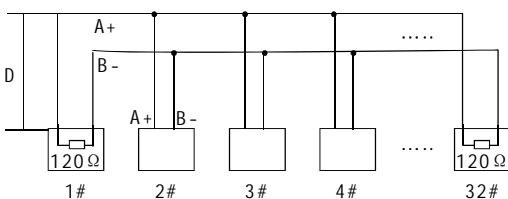

Picture 4-1.2

Ø Problems in practical use

In some circumstances user adopts a star configuration in practical connection. The termination resistors must be connected to the two equipments that are farther away from each other, such as equipment 1# and 15# (refer to picture 4-1.3). As the star configuration is not in conformity with the requirements of Rs485 standards, problems such as signal reflections, lower anti-interference performance arise when the cables are long in the connection. The reliability of control signals are decreased with the phenomena that the dome dose not responds to or just responds at intervals to the controller, or dose continuous operation without stop.

In such circumstances the factory will recommend the usage of Rs485 distributor. The distributor can change the star configuration connection to the mode of connection stipulated in the RS485 standards. The new connection achieves reliable data transmission (refer to picture 4-1.4)

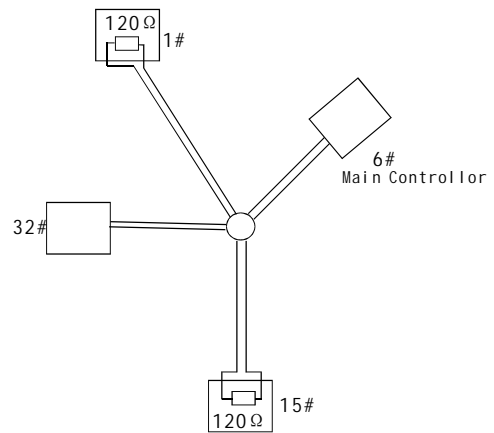

Picture 4-1.3

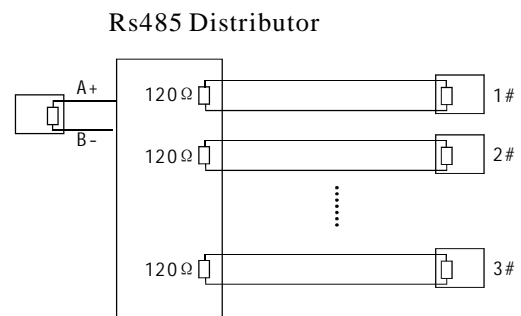

Picture 4-1.4

5.2 Keyboard shortcut operation manual

Working Mode	Shortcut	Operation object	Function
Direct Control Mode and PELCO Matrix Mode	【N】 + 【Cam】	High speed dome	Input Dome ID, press 【Cam】 to select object dome.
	【Tele】	High speed dome	Press 【Tele】 , increase the multiple of lens
	【Wide】	High speed dome	Press 【Wide】 , reduce the multiple of lens
	【Far】	High speed dome	Press 【Far】 , far focus
	【Near】	High speed dome	Press 【Near】 , near focus
	【Close】	High speed dome	Press 【Close】 , reduct the Iris
	【Open】	High speed dome	Press 【Open】 , increase th Iris
	【Set】 + 【N】 + 【Preset】	High speed dome	Adjust the image to object position, press 【Set】 to input preset ID, then press 【Preset】 to set preset.
	【N】 + 【Preset】	High speed dome	Input preset ID, press 【Preset】 to call the preset.
	【SET】 + 【1】 + 【Scan】	High speed dome	Adjust the image to object position, press 【Set】 to input 1, then press 【Scan】 to set scan left limit.
	【SET】 + 【2】 + 【Scan】	High speed dome	Adjust the image to object position, press 【Set】 to input 2, then press 【Scan】 to set scan right limit.
	【1】 + 【Scan】	High speed dome	Input 1, press 【Scan】 to run scan.
	【Set】 + 【N】 + 【Pattern】	High speed dome	Press 【Set】 to input pattern number, press 【Pattern】 to record pattern path.
	【Set】 + 【0】 + 【Pattern】	High speed dome	Press 【Set】 ,input 0, then press 【Pattern】 to save pattern
	【N】 + 【Pattern】	High speed dome	Input pattern number(1-4), press 【Pattern】 to run pattern.
	【N】 + 【Tour】 / 【Tour】	High speed dome	Input tour number, press 【Tour】 or directly press 【Tour】 to run cruise.
【9】 + 【5】 + 【Preset】	High speed dome	Input 95 to call main menu of dome	
PELCO Matrix Mode	【Shift】 + 【Set】	Matrix	Press 【Shift】 and 【Set】 to call mail menu of matrix
	【Prev】	Matrix	Switch to previous dome. Press 【Prev】 to jump the previous dome, press 【Prev】 to hold it for 2s, continuously switch the sixteen domes of connection matrix forwards.
	【Next】	Matrix	Switch to next dome. Press 【Next】 to jump the next dome, press 【Next】 to hold it for 2s, continuously switch the sixteen domes of connection matrix backwards.
	【Stop】	Matrix	Stop to switch.
	【Enter】	Matrix	After program, press 【Enter】 to confirm.
	【N】 + 【MON】	Monitor	Input monitor ID, press 【Cam】 to select object monitor.

6、Keyboard Menu Index

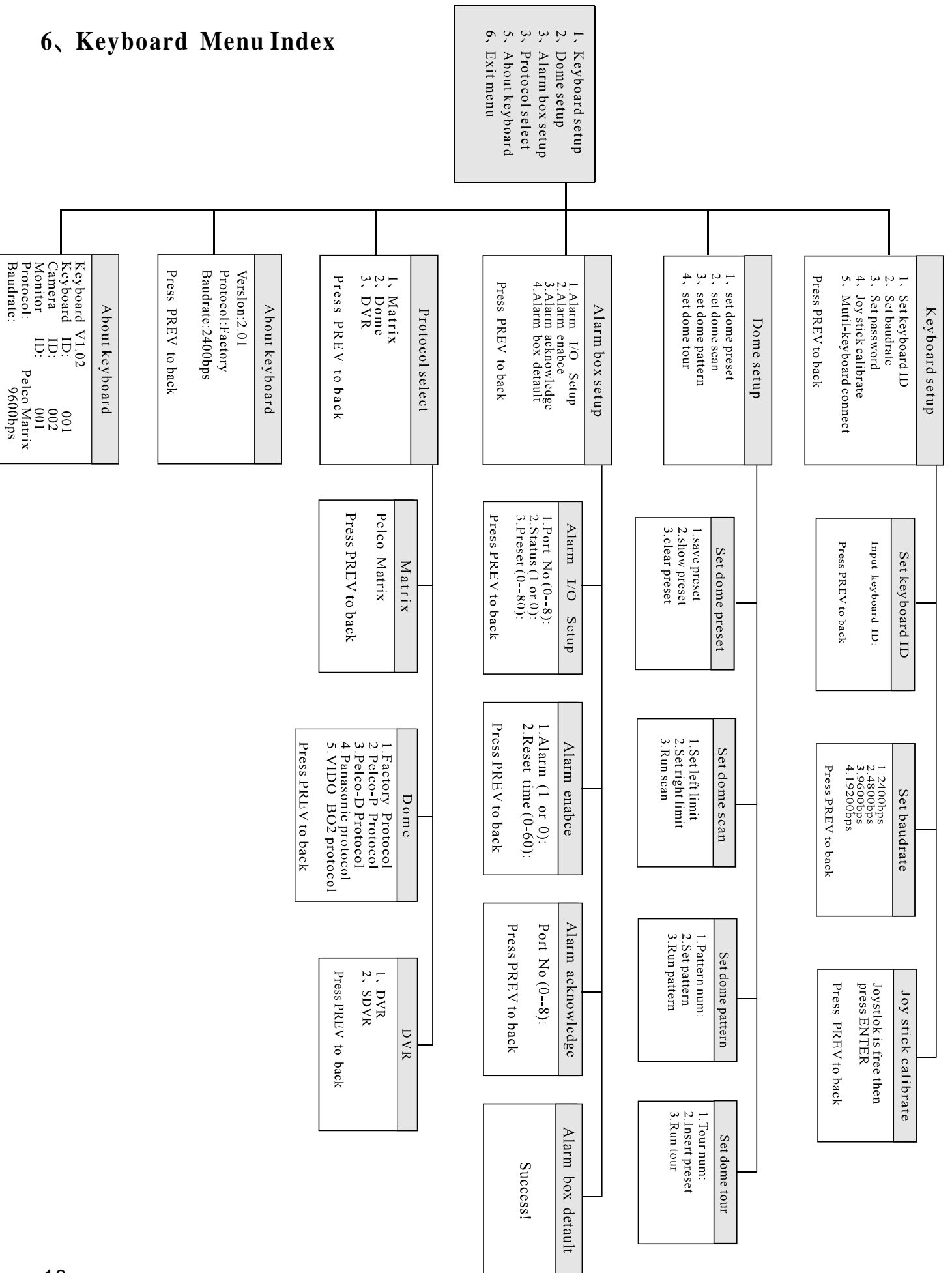

7. Maintenance service terms

1. Range of warranty

- The product will be maintained free for one year.
- The product will be obtained the free maintenance service if the same malfunction appears again within three months.
- Malfunction of products caused by force majeure (such as war, earthquake, lightning strike and so on), abuse, non-standard operation, change of construction, non-normal wear or accident are non-free of warranty.
- Please prevent from the damage which is caused by heavy pressure , the fierce vibration and soaks in the process of transportation and storage, which does not belong to the free maintenance scope.
- Please adopt the way of fission package or original package to transport because the product damage dose not belong to the free maintenance scope if you use the whole packing way , not the original packing way.
- The maintenance services will not be free when the pan/tilt module is disassembled or serviced by the user voluntarily.
- Our company implements the lifetime payable service if the product in malfunction has surpassed the warranty period.
- To the products with defect :if it's in the period of warranty, please fill in the form of warranty information correctly, describe the trouble in details, and provide original sales. invoice or its copy.
- For the damage and loss which was caused by the user's specifically application, factory won't bear any risk and responsibility. The factory compensation made by breach of faith, negligence or tortious won't exceed the amount of the products. The factory won't bear any responsibility for the special, unexpected and continue damage caused by any other reasons.
- Our company has the final right of explanation for the above terms.

2. Warranty terms

- If the products are within the warranty time, the buyer should fill in the warranty card and send back together with the products.

3. Shipping

- If the product needs repaired , you can return it to the manufacturer through the supplier or directly. If you choose the later , please contact us in order to speed up the process. And our company only undertake the one-way freight from manufacturer to customer after maintenance.

