

User's Manual

EZ-0005

78K0/IB2 HBLED Evaluation Board

Target Device

78K0/IB2 Microcontroller

ZBB-CE-09-0009-E

Data Published March 2009

© NEC Electronics Corporation

- The information in this document is current as of March, 2009. The information is subject to change without notice. For actual design-in, refer to the latest publications of NEC Electronics data sheets or data books, etc., for the most up-to-date specifications of NEC Electronics products. Not all products and/or types are available in every country. Please check with an NEC Electronics sales representative for availability and additional information.
- No part of this document may be copied or reproduced in any form or by any means without the prior written consent of NEC Electronics. NEC Electronics assumes no responsibility for any errors that may appear in this document.
- NEC Electronics does not assume any liability for infringement of patents, copyrights or other intellectual property rights of third parties by or arising from the use of NEC Electronics products listed in this document or any other liability arising from the use of such products. No license, express, implied or otherwise, is granted under any patents, copyrights or other intellectual property rights of NEC Electronics or others.
- Descriptions of circuits, software and other related information in this document are provided for illustrative purposes in semiconductor product operation and application examples. The incorporation of these circuits, software and information in the design of a customer's equipment shall be done under the full responsibility of the customer. NEC Electronics assumes no responsibility for any losses incurred by customers or third parties arising from the use of these circuits, software and information.
- While NEC Electronics endeavors to enhance the quality, reliability and safety of NEC Electronics products, customers agree and acknowledge that the possibility of defects thereof cannot be eliminated entirely. To minimize risks of damage to property or injury (including death) to persons arising from defects in NEC Electronics products, customers must incorporate sufficient safety measures in their design, such as redundancy, fire-containment and anti-failure features.
- NEC Electronics products are classified into the following three quality grades: "Standard", "Special" and "Specific".

The "Specific" quality grade applies only to NEC Electronics products developed based on a customer-designated "quality assurance program" for a specific application. The recommended applications of an NEC Electronics product depend on its quality grade, as indicated below. Customers must check the quality grade of each NEC Electronics product before using it in a particular application.

"Standard": Computers, office equipment, communications equipment, test and measurement equipment, audio and visual equipment, home electronic appliances, machine tools, personal electronic equipment and industrial robots.

"Special": Transportation equipment (automobiles, trains, ships, etc.), traffic control systems, anti-disaster systems, anti-crime systems, safety equipment and medical equipment (not specifically designed for life support).

"Specific": Aircraft, aerospace equipment, submersible repeaters, nuclear reactor control systems, life support systems and medical equipment for life support, etc.

- The quality grade of NEC Electronics products is "Standard" unless otherwise expressly specified in NEC Electronics data sheets or data books, etc. If customers wish to use NEC Electronics products in applications not intended by NEC Electronics, they must contact an NEC Electronics sales representative in advance to determine NEC Electronics' willingness to support a given application.

(Note)

- (1) "NEC Electronics" as used in this statement means NEC Electronics Corporation and also includes its majority-owned subsidiaries.
- (2) "NEC Electronics products" means any product developed or manufactured by or for NEC Electronics (as defined above).

Safety Precautions



This document explains matters to be noted for safe use of 78K0/IB2 HBLED Evaluation Board. Be sure to read this document before using 78K0/IB2 HBLED Evaluation Board.

- Be sure to observe all dangers, warnings, cautions, and other instructions contained herein when using this evaluation board.
- This document should be kept handy at all times for ready reference.







Symbols used

This document uses the following symbols for matters to be observed for the safe use of the unit.

The symbols are followed by a brief explanation of the possible extent of problems which may occur if the notices are not observed.

 Danger	The user may suffer death or serious injury and it's risk is high if the warning is not observed.
 Warning	The user may suffer death or serious injury if the warning is not observed.
 Caution	Human injury or property damage may occur if the caution is not observed.



The following symbols express matters which are prohibited in order to prevent injury or accident.

 General prohibition The action mentioned is prohibited.	 Do not touch Touching the specified location may cause injury.	 Do not disassemble Disassembly may cause a problem such as electrical shock or product failure.
 Keep away from water Use near water poses the risk of electrical shock or product failure if moisture were to contact the unit.	 Flammable A nearby flame may cause the unit to catch fire.	 Do not touch with wet hands Touching with wet hands may cause electric shock or product failure.









The following symbols are used for cautions to prevent product failure and accidents.

 General caution Unspecified general cautions.	 Caution Hot Human injury by high temperature may occur.
---	---

The following symbols are used for instructions to prevent product failure and accidents.

 Compulsory action based on an instruction for the user.	 Instruction to unplug the AC adapter.
---	---

Warnings

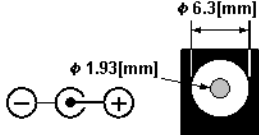
 Warning	
	<p>Be careful to burns. The part of board around LED becomes high temperature.</p>
	<p>Be careful to brightness of LEDs and On/Off period of LEDs. Stimulating of strong light may cause symptoms such as epilepsy by constitution.</p>
	<p>Do not use this board in the purpose except the evaluation of MCU. This board does not take safety measures or anti-EMI measures required for lighting equipment.</p>
	<p>Do not heat the board or expose it to fire, and do not short the terminals. Doing so may cause product failure, generation of heat, fire, or rupture.</p>
	<p>Do not disassemble or modify the board. Doing so may cause product failure, emission of smoke, fire, or electric shock.</p>
	<p>Do not touch with wet hands. Doing so while power is supplied cause product failure or electrical shock.</p>
	<p>Do not look LEDs on this board directly. Doing so may cause weakening eyesight.</p>
	<p>Do not drop or jolt the board. Doing so may break or damage the board, causing fire or electric shock.</p>
	<p>Do not turn on power switch in insufficient state of cable connection such as AC adapter, interface cable. Doing so may cause product failure, generation of heat, fire or electric shock.</p>
	<p>Do not plug in or unplug a connector or cable with power applied to the board. Doing so may cause product failure, generation of heat, fire or rupture.</p>
	<p>Do not carry this board with connecting AC adapter and any cable. Doing so may cause damage of cable and cause product failure, generation of heat, fire or electric shock.</p>
	<p>Use this board with spacer and on the isolated bench. In case conductor contact to the board, it may cause product failure, generation of heat, fire or electric shock.</p>
	<p>Use AC adapter adapted to safety standard of each county. Using non-adopt AC adapter cause product failure, generation of heat, fire or electric shock.</p>
	<p>Use specified AC adapter. Using AC adapter except specified cause product failure, generation of heat, fire or electric shock.</p>
	<p>Use AC adapter with following size and polarity of DC plug. Using another type of AC adapter may cause product failure, generation of heat, fire or electric shock.</p> <div style="text-align: right;">  </div>
	<p>Confirm the outlet is near this board and easily unplugged.</p>



Warning



If smoke or an abnormal smell or sound is emitted, or heating occurs, promptly switch off the board power and unplug from AC power supply.

Using the board in such a state poses a risk of fire, burning, or electric shock.

Cautions



Caution



Do not use or store this board in any of the following locations.

- Environments with copious water, humidity, steam, dust, fumes, etc.
- Environments where static electricity or electrical noise is readily generated.

Such influences can lead to electric shock or product failure.

In case liquid enters the board, cut the power supply, and consult your dealer or NEC Electronics sales representative.

Even if the unit appears to be dry, internal moisture may remain.



Do not touch LEDs on this board directly.

Doing so may cause product failure.



To prevent static electricity damage, guard against energizing when touching metal parts such as the connector.

Static electricity can cause product failure.

CONTENTS

CHAPTER 1	OVERVIEW	7
CHAPTER 2	SPECTIFICATION	9
CHAPTER 3	OPERATION	14
APPENDIX A	SCHEMATICS	24
APPENDIX B	REVISION HISTORY	26

1. Overview

78K0/IB2 HBLED Evaluation Board is an evaluation kit for high brightness LED application using the 78K0/IB2 microcontroller.

This board can operate by DC5V power supply provided from AC adapter. Please prepare AC adapter by yourself.

78K0/IB2 controls current of the high brightness LED to be constant. It can also control the evaluation board operating with analog input. When connecting with a Lighting Communication Master Evaluation Board (EZ-0008), LEDs can be controlled to dim with DMX512 protocol or DALI protocol.

Figure 1. System setup example (OCD mode / DALI protocol control)

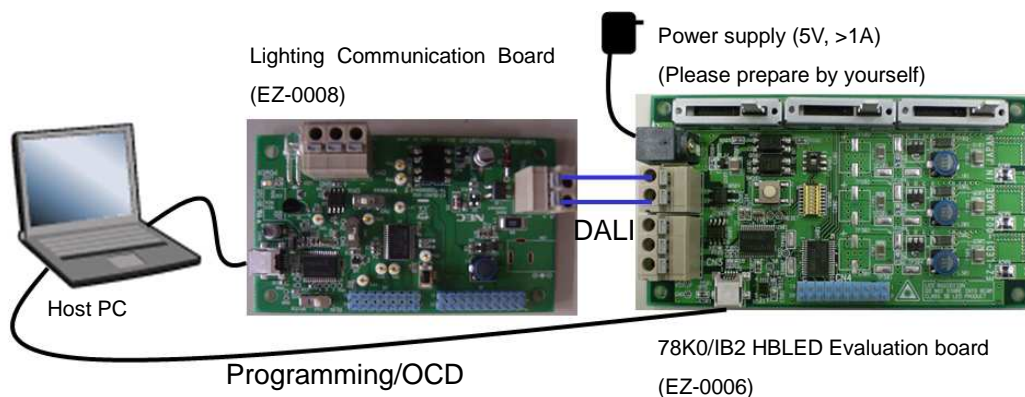

1.1 Feature

- 3 channels constant current control without driver IC but only a 78K0/IB2 microcontroller
 - Buck topology
 - 300mA per channel
 - 5V supply voltage
- Up to 3 kind of control interface supported
 - DMX512 protocol communication interface
 - DALI protocol communication interface
 - Analog volume control interface
- Programming / On-chip debug supported

1.2 Operation Mode

- PROG mode
 - Flash programming through the USB interface
- RUN mode
 - Three control interfaces are offered on this board.
 - DMX512 protocol control interface
 - DALI protocol control interface
 - Analog volume control interface
- On-chip debug mode
 - On-chip debug through the USB interface

1.3 Related product information

As for the information of related products for this board, please see NEC Electronics Web site.

URL <http://www.necel.com/micro/en/solution/lighting/index.html>

2. Specification

This chapter described the specification of 78K0/IB2 HBLEDD Evaluation Board



2.1 Appearance of the board

The following figure shows the appearance of 78K0/IB2 HBLEDD Evaluation Board.

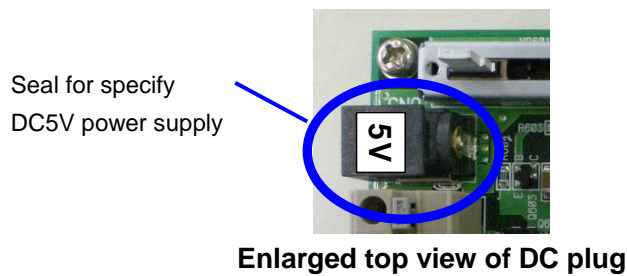
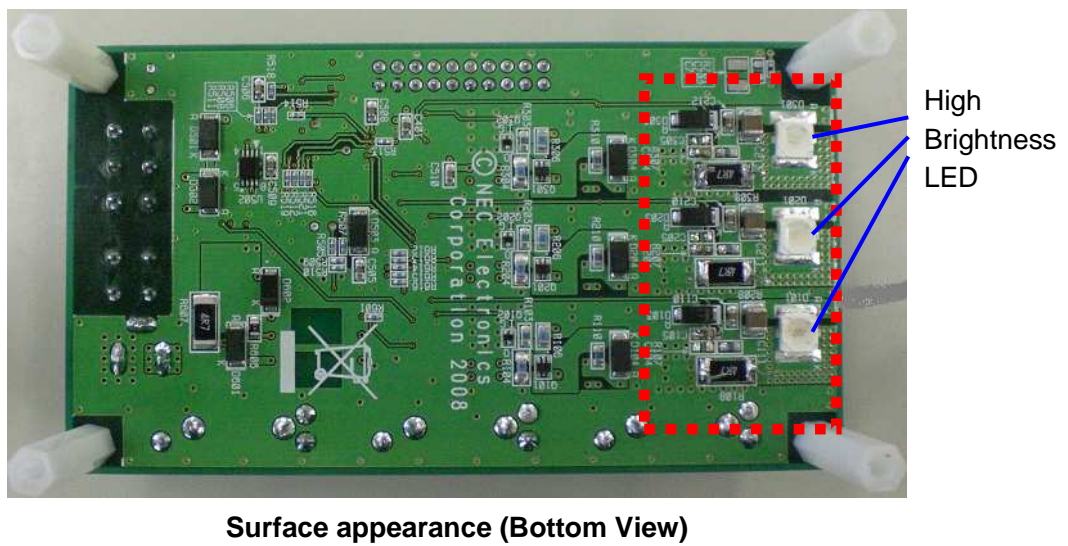
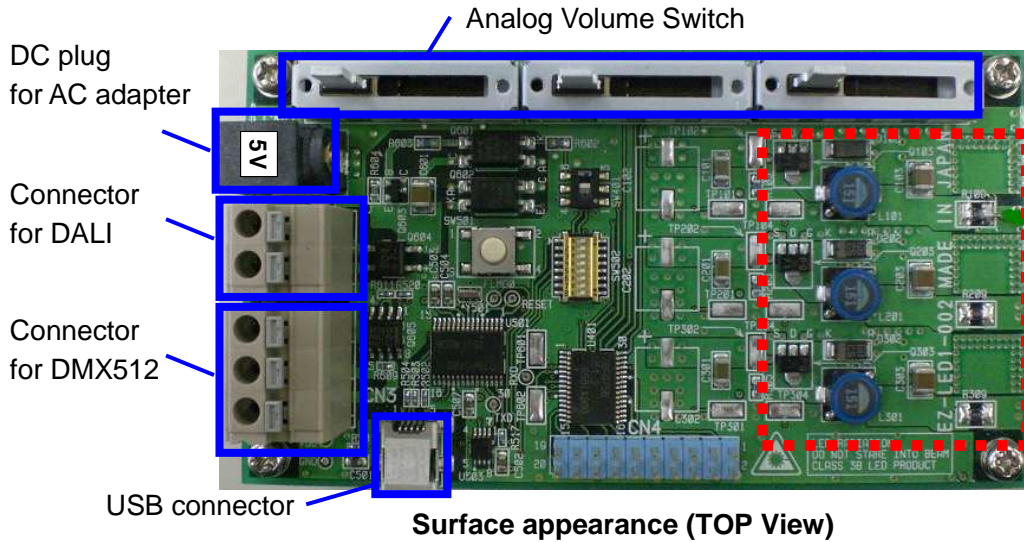
Figure 2. Appearance of 78K0/IB2 HBLEDD Evaluation Board.



Warning

	<p>Be careful to burns. The part of board especially the area enclosed with RED line becomes high temperature.</p>
	<p>Do not look LEDs on this board directly. Doing so may cause weakening eyesight. Use this board so that LED mounting surface becomes the lower (the back).</p>
	<p>Use specified AC adapter. Using AC adapter except specified cause product failure, generation of heat, fire or electric shock.</p>

Caution

	<p>Do not touch LEDs on this board directly. Doing so may cause product failure.</p>
---	---

2.2 Detail specification

Board name : EZ-LED1-002
Power supply : 5[V] >1[A]
Microcontroller : 78K0/IB2 (UPD78F0756MC-CAB-AX)
LED mounted: Nichia
 CH0: NS6R083 (RED)
 CH1: NS6G083 (GREEN)
 CH2: NS6B083 (BLUE)
LED forward current: 300[mA](typ.) per channel
DC plug : Switchcraft RAPC722 (Center pin ϕ 1.93mm, Plug ϕ 6.3mm (max))

Figure 3. Polarity and shape of DC plug

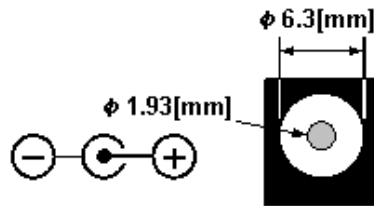

2.3 Power supply

The following AC adaptor or dc power supplier is recommended to be applied to 78K0/IB2 HBLED Evaluation Board

①AC Adaptor

Output voltage : 5[V]
Output current : 2[A] (recommend), over 1[A]
Connector : refer to figure 3
Type : Switching regulator type with over current protect circuit
Do not use AC adapter whose output voltage is guaranteed only when rated load current flows.

②DC power supplier

Output voltage : 5[V]
Output current : over 1[A]
Connector : refer to figure 3

 Warning	
	Use AC adapter adapted to safety standard of each county. Using non-adopt AC adapter cause product failure, generation of heat, fire or electric shock.

Please refer Appendix A for schematic of 78K0/IB2 HBLED Evaluation Board

2.4 Switch setting and Connector pin assign

Table1. DIP Switch SW502 setting

Bit	ON	OFF
1	RUN mode for 78K0/IB2	PROG/OCD mode for 78K0/IB2
2	Not specified.	
3	Different combination of these three pins can generate varies voltage inputted into ANI0 pin of microcontroller. They are recommended to be used as custom mode selector.	
4		
5	Enable communication between 78K0/IB2 and USB microcontroller	Reserve for USB microcontroller firmware updating without a USB cable.
6	Enable communication between 78K0/IB2 and USB microcontroller	Reserve for USB microcontroller firmware updating without a USB cable.
7	Connect TxD6 pin of 78K0/IB2 to lighting communication circuit DMX512 or DALI	Disconnect TxD6 pin of 78K0/IB2 and communication circuit. User can connect his own communication circuit to 78K0/IB2 through TP601.
8	Connect RxD6 pin of 78K0/IB2 to lighting communication circuit DMX512 or DALI	Disconnect RxD6 pin of 78K0/IB2 and communication circuit. User can connect his own communication circuit to 78K0/IB2 through TP602.

Table 2. Other Switches setting

No.	Description
SW501	RESET button
SW401	Communication interface selection switch. Setting to 1,4 side :DMX512 interface Setting to 3,6 side :DALI interface

Table 3. Pin assign for CN4

Pin No.	78K0/IB2 microcontroller pin name
1	Not connected
2	P21/ANI1/AMPOUT/PGAIN
3	P01/TO00/TI010
4	Not connected
5	Not connected
6	P34/TOX11/INTP4
7	VDD
8	Not connected
9	VDD
10	Not connected
11	Not connected
12	Not connected
13	Not connected
14	P02/SSI11/INTP5
15	Not connected
16	P35/SCK11
17	GND
18	P36/SI11
19	GND
20	P37/SO11

3. Operation

3.1 Preparation

3.1.1 Driver installation

Install the driver when connecting the 78K0/IB2 HBLED Evaluation Board (EZ-0005) to the PC by using a USB cable for the first time.

- ① Download driver from following URL.
URL <http://www.necel.com/micro/en/solution/lighting/download.html>
- ② When connecting this board to PC by using USB cable, "Found New Hardware Wizard" dialog box is displayed.
Select "Yes, now and every time I connect a device", and click [Next].
- ③ Select "Install from a list or specific location (Advanced)", and click [Next].
- ④ Select "Include this location in the search" and then click [Browse]
Specify the folder to which download files are saved, and click [Next]
- ⑤ Installation starts
Click [Continue Anyway] while "Hardware Installation" dialog is displayed.
- ⑥ Click [Finish]. Installation is complete.

3.1.2 Programmer installation

Please install the programmer for 78K0/IB2 flash programming.

- ① Download programming software "WriteEZ3" and related parameter file from following URL.
URL <http://www.necel.com/micro/en/solution/lighting/download.html>
- ② Decompress the downloaded pack.

3.1.3 On-chip debugger and compiler installation

Please install On-chip debugger and compiler if On-chip debug mode of this board is required to be used.

- ① Download integrated debugger "ID78K0-QB", NEC Electronics development tools "PM+", "RA78K0", "CC78K0", and device file for the target device 78K0/IB2 microcontroller.
URL <http://www.necel.com/micro/en/solution/lighting/download.html>
- ② Install "RA78K0". Project manager "PM+" will be installed automatically.
- ③ Install "CC78K0"
- ④ Install device file
- ⑤ Install "ID78K0-QB"

3.1.4 Communication GUI installation

To control the LED by DMX512 or DALI protocol, NEC Electronics offers Lighting communication board (EZ-0008) and GUI for easy evaluation.

About the lighting communication board (EZ-0008), please refer to Lighting Communication Master Evaluation Board (EZ-0008) Quick Start Guide (ZUD-CE-09-0018).

- ① Download DMX512 or DALI GUI from the following URL.
URL <http://www.necel.com/micro/en/solution/lighting/download.html>
- ② Install the GUI for the communication protocol which is supposed to be used.
For detail, please refer following User's Manual
DALI master controller GUI User's Manual (U19607)
DMX512 master controller GUI User's Manual (U19596)

3.1.5 Sample programs

NEC Electronics offers several sample programs for LED control of 78K0/IB2 HBLED evaluation board. Download the sample programs from the following URL for reference.

URL <http://www.necel.com/micro/en/solution/lighting/download.html>

3.2 PROG mode

3.2.1 Start Programming

- ① Set SW502.1 of this board to "OFF".
- ② Insert 5V power supply.
- ③ Connect this board to PC by using USB cable.

Figure 4. Connection when programming to 78K0/IB2

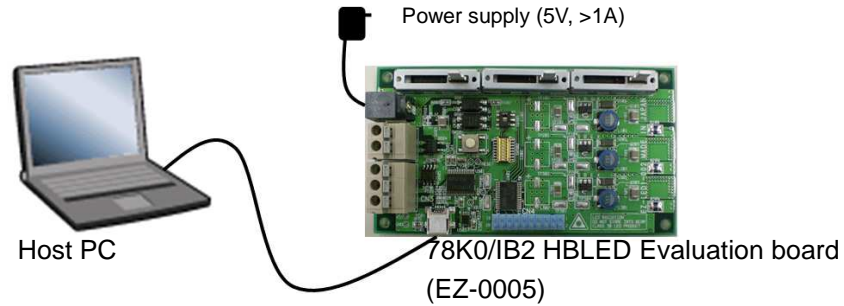

- ④ Start up "WriteEZ3"

Figure 5. Main window of WriteEZ3

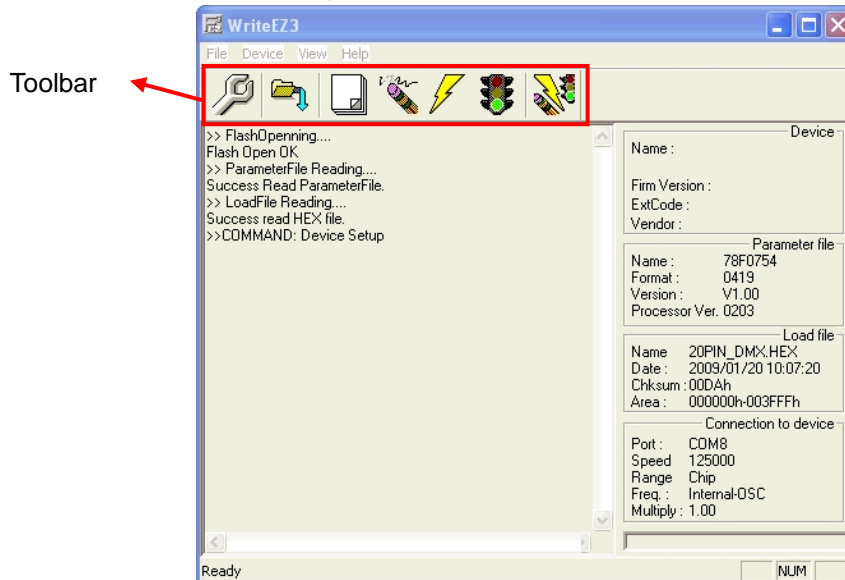

- ⑤ Click [Setup] to open the device setup dialog box.
Select parameter file 78F0756.prm
Specify the COM port for communication between host PC and this board.

Figure 6. Device Setup Dialog box

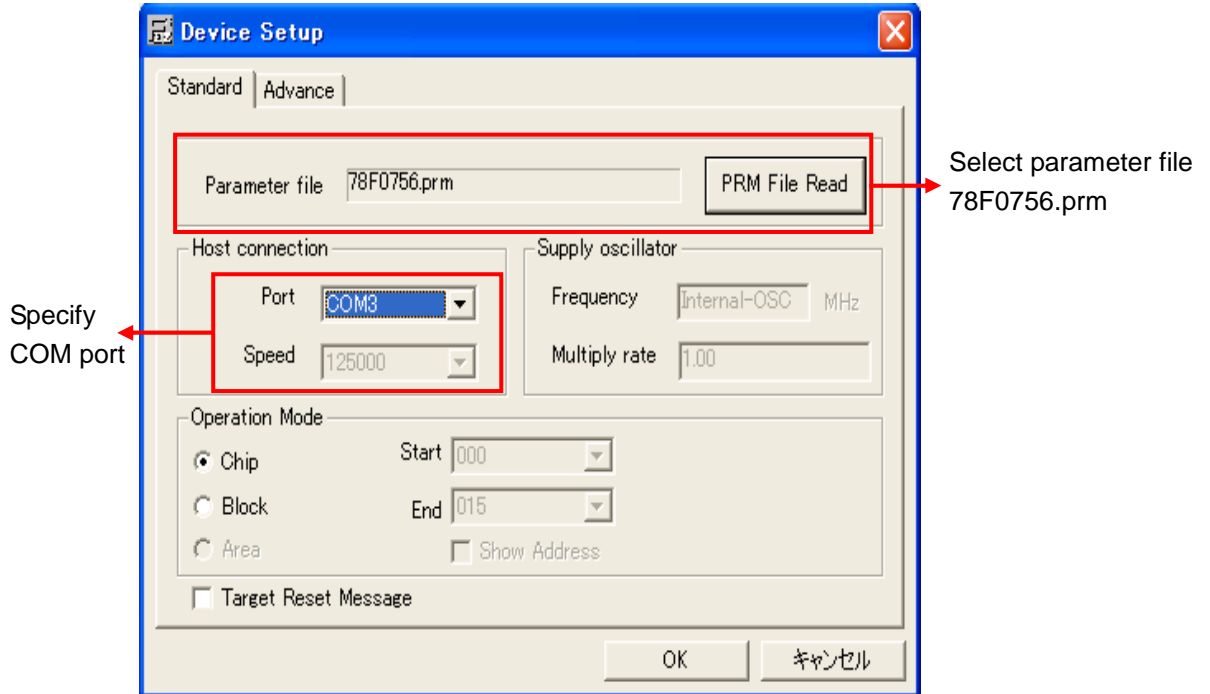

- ⑥ Click [Load] to select the hex file which is expected to be programmed.
- ⑦ Click [Autoprocedure] to do flash programming.
- ⑧ Close "WriteEZ3"
- ⑨ Disconnect the power supply and USB cable

3.3 Run mode

3.3.1 Control LEDs by DMX512 protocol

- ① Programming the Hex file supporting DMX512 protocol.
Please refer **3.2 Programming mode** for programming.
- ② Confirm bit 1, 7 and 8 of SW502 are set to "ON", and SW401 is set to "1,4" side.
- ③ Connect this board and Lighting communication master board (EZ-0008) or your own master for DMX512 through DMX512 interface CN7

Figure 7. Example of connection for DMX512 protocol control (RUN mode)

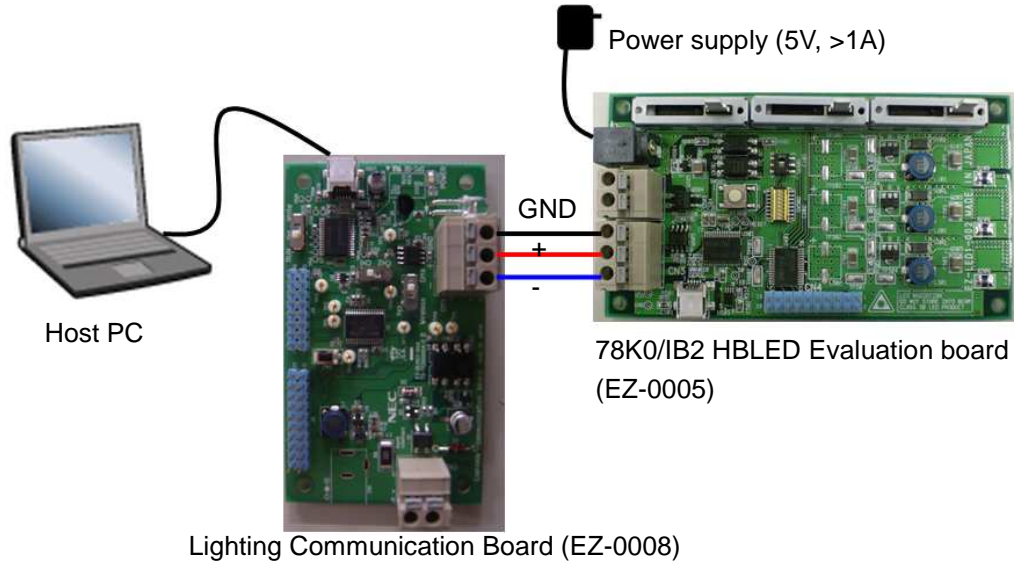

- ④ Provide DC 5V through CN9.
- ⑤ Send DMX512 codes to slave by DMX512 Master Controller GUI or your own software.
- ⑥ Disconnect the DC power from DC plug when finished evaluation.
- ⑦ Disconnect the 78K0/IB2 HBLED evaluation board and the master board.

Note1: To find details of DMX512 Master Controller GUI, please refer to User's Manual of DMX512 Master Controller GUI (U19596).



Note2: In the sample hex file released on web, the DMX512 communication data is defined as following.

Table 5 : DMX512 data assignment in sample program

	Control the Duty
Start Code	00h
DMX512 DATA1	LED(CH0) brightness
DMX512 DATA2	LED(CH1) brightness
DMX512 DATA3	LED(CH2) brightness

Since this sample defined 28 dimming steps, the target step is calculated from DMX512 data as the following equation: target step = data*28/256.

 **Warning**

	<p>Be careful to burns. The part of board especially the area enclosed with RED line becomes high temperature.</p>
	<p>Do not look LEDs on this board directly. Doing so may cause weakening eyesight. Use this board so that LED mounting surface becomes the lower (the back).</p> <p>Do not plug in or unplug a connector or cable with power applied to the board. Doing so may cause product failure, generation of heat, fire or rupture.</p>

 **Caution**

	<p>Do not touch LEDs on this board directly. Doing so may cause product failure.</p>
---	---

3.3.2 Control LEDs by DALI protocol

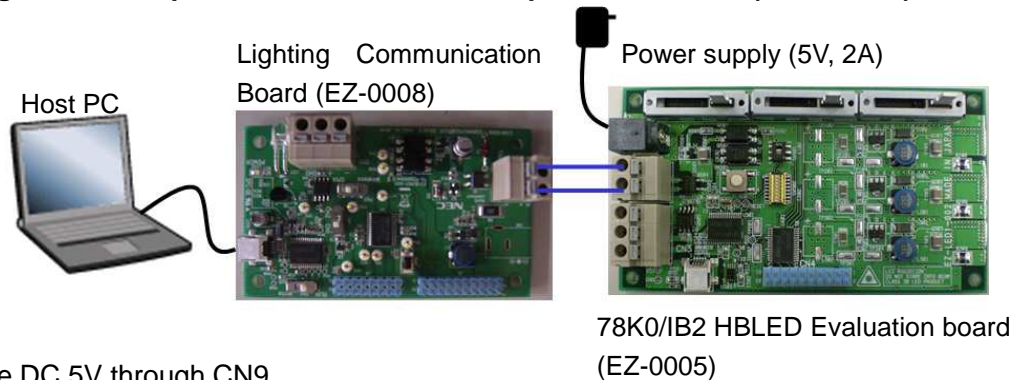

- ① Programming the Hex file supporting DALI protocol.
Please refer **3.2 Programming mode** for programming.
- ② Confirm bit 1, 7 and 8 of SW502 are set to "ON", and SW401 is set to the "3,6" side.
- ③ Connect this board with Lighting communication master board (EZ-0008) or your own master for DALI through DALI interface CN8.

Figure 8. Example of connection for DALI protocol control (RUN mode)



- ④ Provide DC 5V through CN9
- ⑤ Send DALI codes to slaves by DALI Master Controller GUI or your own software.
- ⑥ Disconnect the DC power from DC plug when finished evaluation.
- ⑦ Disconnect the 78K0/IB2 HBLED evaluation board and the master board.



Note1: To find details of GUI, please refer to the User's Manual of DALI Master Controller GUI (U19607).

 Warning	
	<p>Be careful to burns. The part of board especially the area enclosed with RED line becomes high temperature.</p>
	<p>Do not look LEDs on this board directly. Doing so may cause weakening eyesight. Use this board so that LED mounting surface becomes the lower (the back).</p> <p>Do not plug in or unplug a connector or cable with power applied to the board. Doing so may cause product failure, generation of heat, fire or rupture.</p>

 Caution	
	<p>Do not touch LEDs on this board directly. Doing so may cause product failure.</p>

3.3.3 Control LEDs by Analog input (Volume Switches)

- ① Programming the Hex file supporting analog input control.
Please refer **3.2 Programming mode** for programming.
- ② Confirm bit 1, 7 and 8 of SW502 are set to "ON".
- ③ Provide DC 5V through CN9
- ④ Move slide switch VR601~VR603, the brightness of LED will change.
- ⑤ Disconnect the DC power from DC plug when finished evaluation.

 Warning	
	Be careful to burns. The part of board especially the area enclosed with RED line becomes high temperature.
	Do not look LEDs on this board directly. Doing so may cause weakening eyesight. Use this board so that LED mounting surface becomes the lower (the back).

 Caution	
	Do not touch LEDs on this board directly. Doing so may cause product failure.

3.4 On-chip Debug mode



- ① Set bit 1 of SW502 to “OFF”, and confirm bit 5 to 8 of SW502 are set to “ON”.
- ② Connect this board to host PC with USB cable.
- ③ Provide DC 5V to this board.
- ④ Start up debugger ID78K0-QB. For details of debugger operation, please refer to the User's Manual of debugger.
- ⑤ Close ID78K0-QB when finished on-chip debug.
- ⑥ Disconnect the power supply
- ⑦ Disconnect the USB cable.
- ⑧ Disconnect all other cables including communication cable for DMX512 or DALI.

Note: To use on-chip debug function, some area of the 78K0/IB2 microcontroller must be secured. When using NEC Electronics compiler RA78K0, CC78K0, area can be secured by setting the linker option. To use the on-chip debug function, check the check box “On-chip debugger [-go]”.

If the pseudo RRM function is not expected to be used, 256 bytes should be secured.

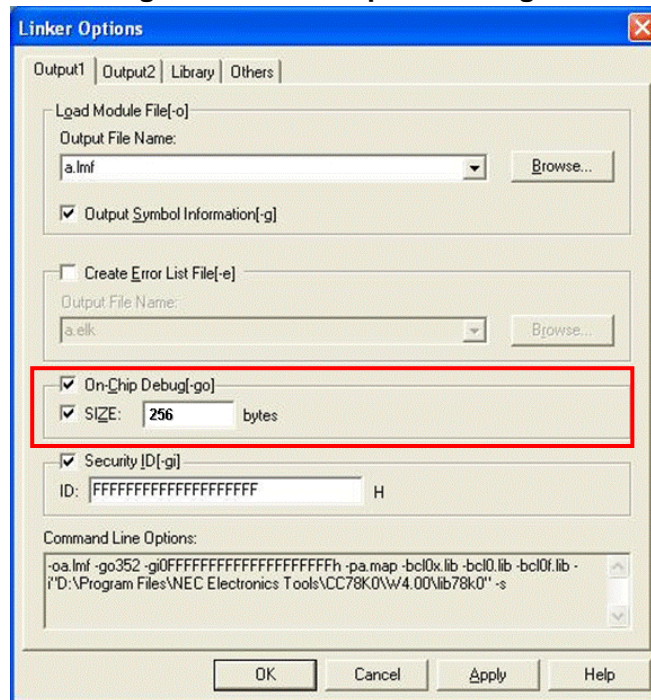
Figure 9. Linker option setting



 Warning	
	<p>Be careful to burns. The part of board especially the area enclosed with RED line becomes high temperature.</p>
	<p>Do not look LEDs on this board directly. Doing so may cause weakening eyesight. Use this board so that LED mounting surface becomes the lower (the back).</p>

	<p>Do not plug in or unplug a connector or cable with power applied to the board. Doing so may cause product failure, generation of heat, fire or rupture.</p>
--	---

 Caution	
	<p>Do not touch LEDs on this board directly. Doing so may cause product failure.</p>

Appendix A Schematic

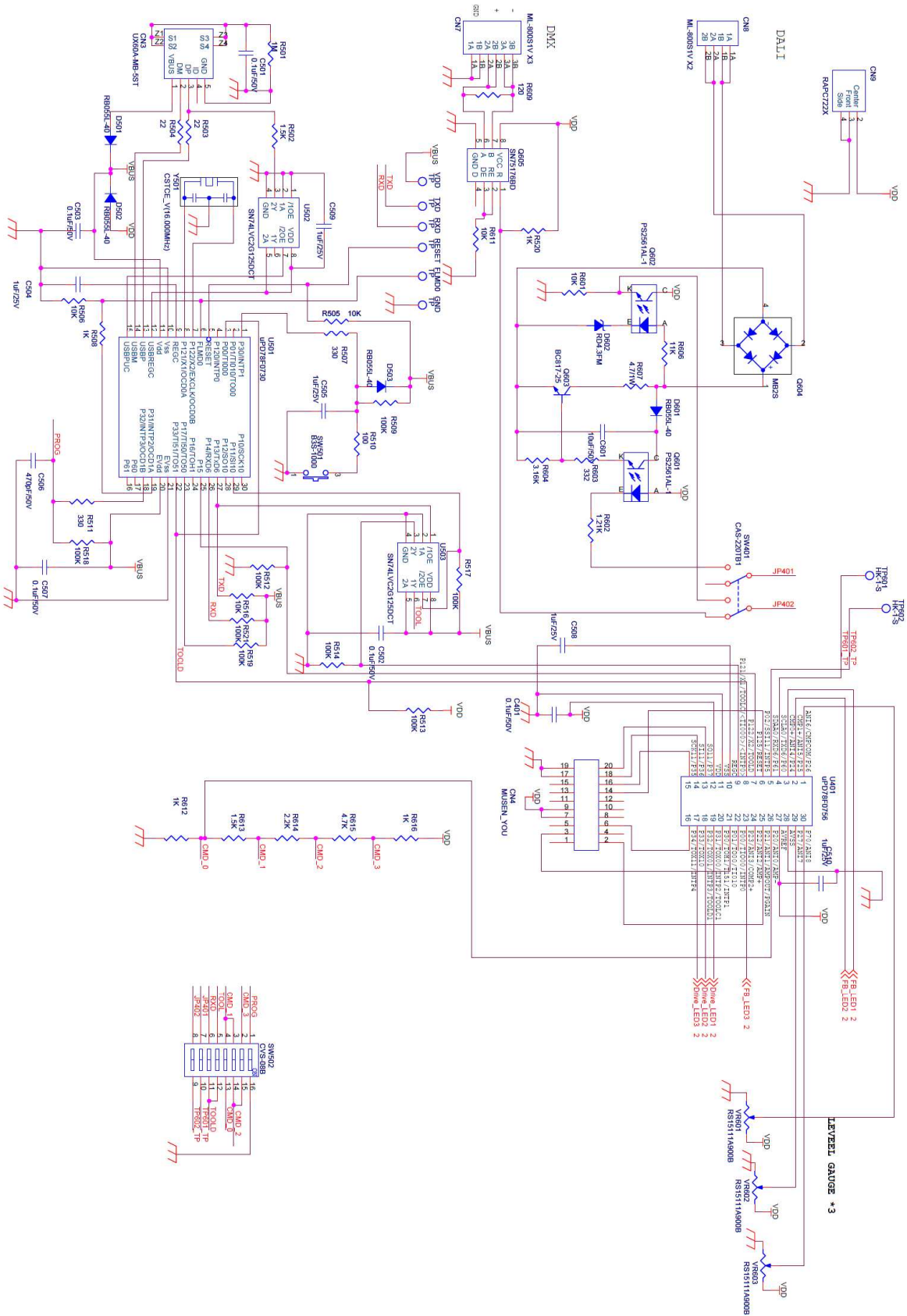

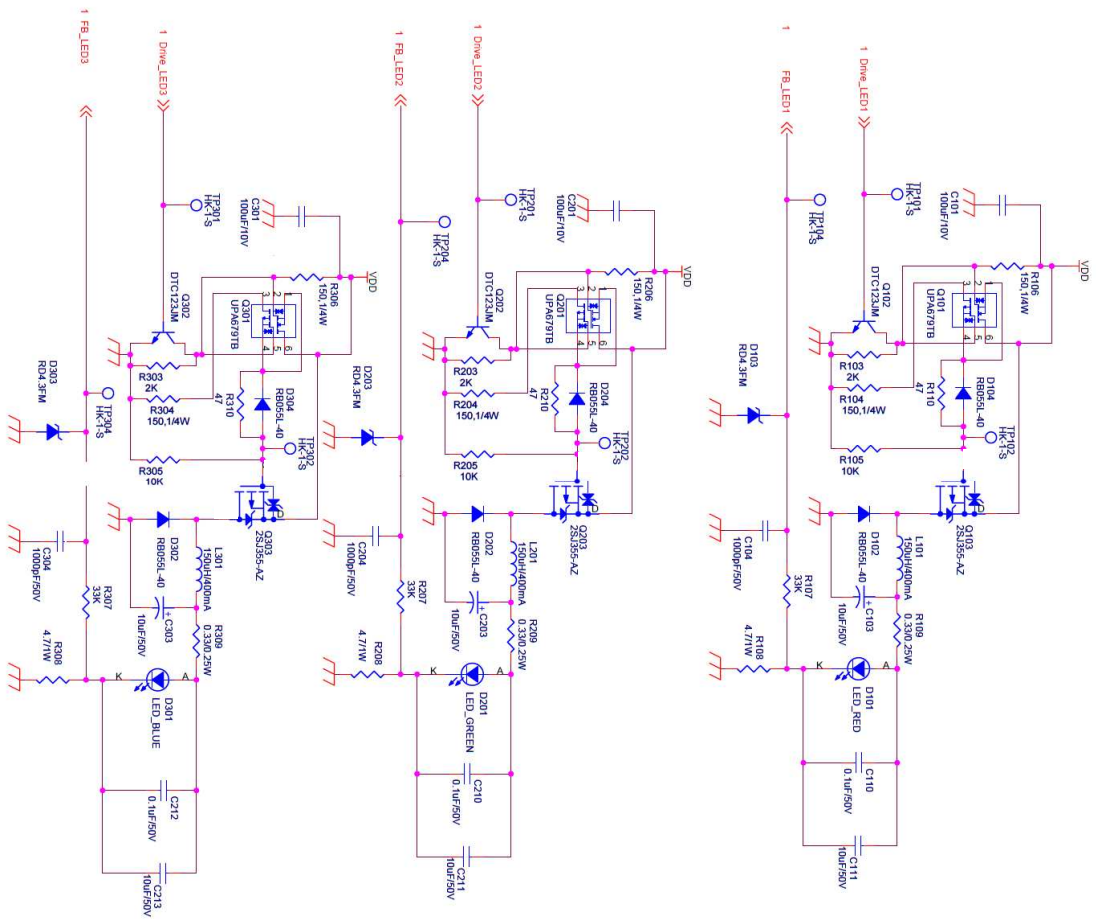

Appendix B Revision History

Revision	Modified Points	Page
Rev.1.0	First edition	

***For further information,
please contact:***

NEC Electronics Corporation

1753, Shimonumabe, Nakahara-ku,
Kawasaki, Kanagawa 211-8668,
Japan

Tel: +81-44-435-111

<http://www.necel.com/>

[Technical Support]

Multipurpose Microcomputer System Division, NEC Electronics Tel: +81-44-435-9452

Data Published March 2009