

Quick Start Guide

How to Install the Bundled Software
How to Use Your "WALKMAN"



NWZ-A864/A865/A866/A867

©2011 Sony Corporation Printed in Malaysia

Contents

Please check the items in the package.

- "WALKMAN" (1)
 - Headphones (1)
 - Earbuds (Size S, L) (1)
 - USB cable (1)
 - Attachment (1)
- Use when connecting your "WALKMAN" to the cradle (not supplied), etc.



- Quick Start Guide (this manual)
 - Software
- The software is stored in the built-in flash memory of your "WALKMAN," and includes the following items:
- Media Go
 - WALKMAN Guide
 - User Guide, etc.
- For details on how to install, refer to "How to Install the Bundled Software (User Guide included)."

About Windows Operating System

Make sure that the OS is Windows XP (Service Pack 3 or later), Windows Vista*¹ (Service Pack 1 or later) or Windows 7*¹.

*¹ [Compatibility mode] for Windows XP is not supported.

Transferring Music

From CDs, etc., using Media Go



Media Go supports data transfer from iTunes 10 to your "WALKMAN."

By drag-and-drop using Windows Explorer



Note

- Media Go does not support contents that use digital rights management technology ("WM-DRM") for Windows Media. If you transfer "WM-DRM" contents, use Windows Media Player. Refer to "Specifications" - "Specifications" - "Supported file format" in the User Guide (HTML document) to check if your "WALKMAN" support "WM-DRM" contents.

For details on transferring music, videos, photos or podcasts, refer to the User Guide. The User Guide can be readily viewed from the WALKMAN Guide.

How to Install the Bundled Software (User Guide included)

1 Connect your "WALKMAN" to your computer.

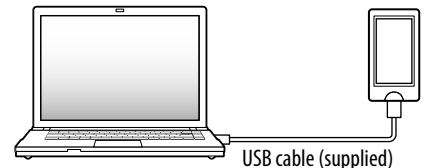

2 Select the following order with the computer.

Select [start] - [My Computer] or [Computer] - [WALKMAN] - [Storage Media].

3 Double-click [Setup.exe].

The install wizard appears.

- When you execute [Setup.exe], the [Setup.exe] file stored in the [Storage Media] folder of your "WALKMAN" is copied to your computer for backup, and WALKMAN Guide and Media Go are installed to your computer.

4 Follow the on-screen instructions.

After executing [Setup.exe], the WALKMAN Guide shortcut appears on the desktop of your computer.

5 Double-click (WALKMAN Guide) on the desktop to start the WALKMAN Guide.

For details on transferring music, etc., refer to the User Guide included in the WALKMAN Guide.

Hint

- You can start the WALKMAN Guide and Media Go from the [start] menu (displayed by clicking [start]).
- If you delete the [Setup.exe] file in your "WALKMAN" by formatting the built-in flash memory of your "WALKMAN," copy [Setup.exe] file and [Install] folder from the [Backup] folder on the computer to your "WALKMAN." Connect your "WALKMAN" to the computer on which to install, and follow the above procedure from step 1 to install. After installing, delete [Setup.exe] file and [Install] folder from your "WALKMAN." The backup data is preserved in the following [C:] drive on your computer by the default install setting.
C:\Program Files*\Sony\WALKMAN Guide\NWZ-A860\Backup

*¹ [Program Files(x86)] may be displayed depending on the computer OS.

What can you do with the WALKMAN Guide ?

The WALKMAN Guide includes the following items:

- User Guide
The following contents can be viewed in your web browser.
 - Details on how to use your "WALKMAN"
 - How to use software to transfer content to your "WALKMAN"
 - Troubleshooting
- Customer Registration Link
- Customer Support Link
- Other useful Links
Includes link information, etc., on the download site.

The bundled items differ depending on the country/region of purchase.

Hint

- After executing [Setup.exe], you can use the free space in the [Storage Media] folder more effectively by formatting the built-in flash memory of your "WALKMAN." To format the built-in flash memory of your "WALKMAN," see "To initialize (format) your "WALKMAN"" on the backside.

How to Use your "WALKMAN"

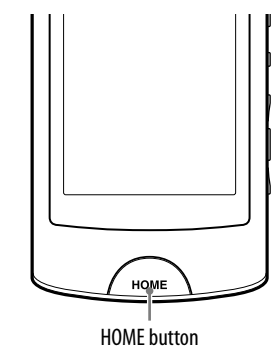

Charging the Battery

The battery of your "WALKMAN" is recharged while your "WALKMAN" is connected to a running computer.

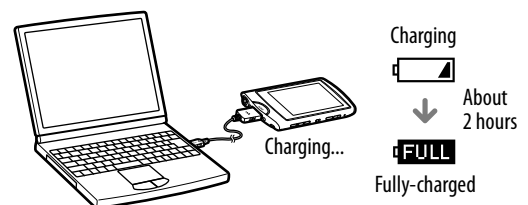

Turning your "WALKMAN" On and Off

To turn on	Press any button.
To turn off	Press and hold the HOME button.

How to use the Home menu

The Home menu appears when you press the HOME button. The Home menu is the starting point to play audio, search for songs, changing settings, etc. From the Home menu, you can select the desired item on the screen by touch screen operations.

Tap an icon, item, control button, etc., on the screen to operate your "WALKMAN." Also, drag up or down to scroll through a list, and flick to scroll quickly through a list or thumbnails.

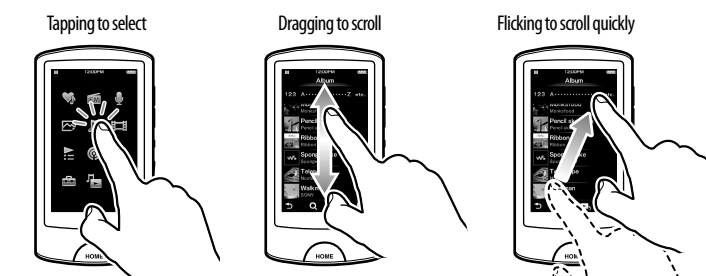

Home menu

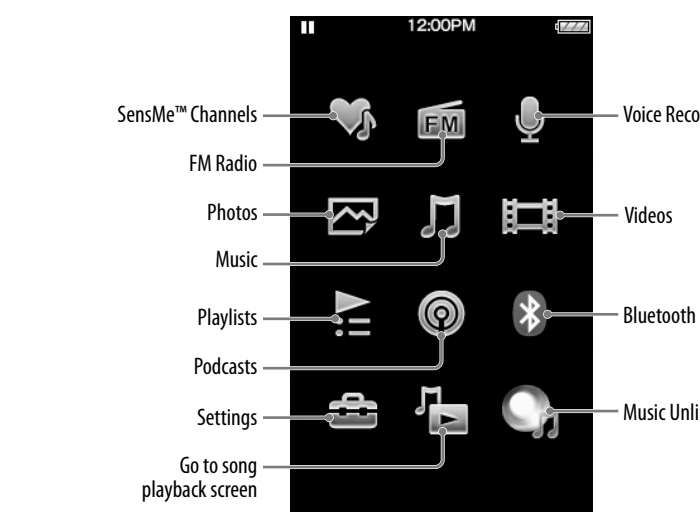

* 4 4 1 5 3 7 9 1 1 * (1)

Parts and Controls

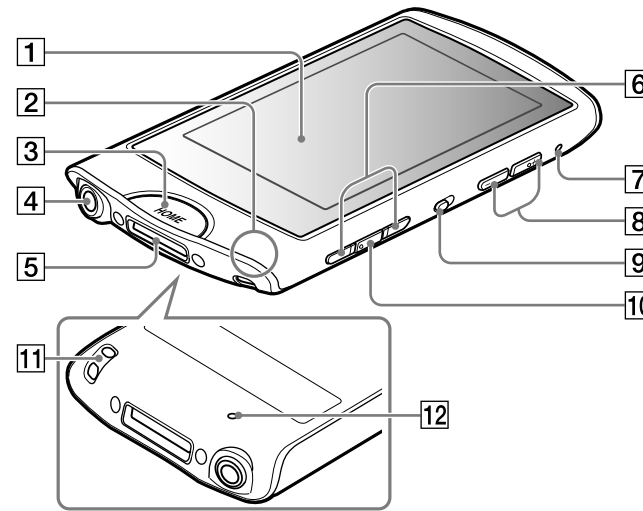

1 Touch screen

Touch (tap) an icon, item, control button, etc., on the screen to operate your "WALKMAN."

2 Microphone

Use to make voice recordings.

3 HOME button

Press to display the Home menu.

Press and hold to place your "WALKMAN" into standby mode.

4 Headphone jack

Connect the USB cable (supplied), or peripheral devices (not supplied).

5 WM-PORT jack

Connect the USB cable (supplied), or peripheral devices (not supplied).

6 Playback buttons

Use to play/pause, stop, and other playback functions.

7 Bluetooth indicator

Indicator light for Bluetooth connectivity.

8 VOL +*1/- button

Use to adjust volume.

9 HOLD switch

Use to lock the touch screen.

10 Play/Pause button

Use to play/pause the audio.

11 Strap hole

Use to attach a strap.

12 RESET button

Use a small pin, etc.

*1 There are tactile dots. Use them to help with button operations.

Troubleshooting

If your "WALKMAN" does not function as expected, try the following steps to resolve the issue.

1 Find the symptoms of the issue in "Troubleshooting" in the User Guide (HTML document), and try any corrective actions listed.

For details on connecting to a computer, see the tables on the right.

2 Connect your "WALKMAN" to your computer to charge the battery.

You may be able to resolve some issues by charging the battery.

3 Press the RESET button with a small pin, etc.

Before resetting your "WALKMAN," check that no song, video, etc. is being played back. You can then reset your "WALKMAN" safely.

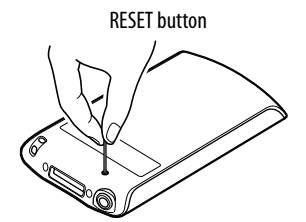

4 Check information on the issue in the Help of each software.

5 Look up information on the issue on one of the customer support Web sites.

About the customer support Web sites, see "For the latest information."

6 If the approaches listed above fail to resolve the issue, consult your nearest Sony dealer.

Symptom	Cause/Remedy
Your "WALKMAN" cannot charge the battery.	<ul style="list-style-type: none"> The USB cable is not connected to a USB connector on your computer properly. <ul style="list-style-type: none"> → Disconnect the USB cable, and then reconnect it. → Use the supplied USB cable. The battery is charged in an ambient temperature out of the range of 5 °C (41 °F) to 35 °C (95 °F). <ul style="list-style-type: none"> → You cannot charge the battery when the icon appears. Charge the battery in an ambient temperature of 5 °C (41 °F) to 35 °C (95 °F). The computer is not on. <ul style="list-style-type: none"> → Turn on the computer. Your computer has entered Sleep or Hibernation status. <ul style="list-style-type: none"> → Release the computer from Sleep or Hibernation status. A USB hub is being used. <ul style="list-style-type: none"> → Connecting your "WALKMAN" via a USB hub may not work. Connect your "WALKMAN" to your computer using the USB cable (supplied). The operating system installed on the computer is not supported by your "WALKMAN." <ul style="list-style-type: none"> → To charge your "WALKMAN," connect your "WALKMAN" to a computer with the operating system that is supported by your "WALKMAN." You have not used your "WALKMAN" for more than a year. <ul style="list-style-type: none"> → Depending on the conditions under which your "WALKMAN" is used, the battery may have been deteriorated. Consult your nearest Sony dealer.
[Connected USB. The player cannot be operated.] or [Connected USB (MTP). The player cannot be operated.] does not appear when connected to the computer with the USB cable (supplied) (The computer does not recognize your "WALKMAN").	<ul style="list-style-type: none"> The USB cable is not connected to a USB connector on your computer properly. <ul style="list-style-type: none"> → Disconnect the USB cable, and then reconnect it. → Use the supplied USB cable. A USB hub is being used. <ul style="list-style-type: none"> → Connecting your "WALKMAN" via a USB hub may not work. Connect your "WALKMAN" directly to your computer using the USB cable (supplied). The USB connector on your computer may have a problem. <ul style="list-style-type: none"> → Connect your "WALKMAN" to another USB connector on your computer.

Symptom	Cause/Remedy
[Connected USB. The player cannot be operated.] or [Connected USB (MTP). The player cannot be operated.] does not appear when connected to the computer with the USB cable (supplied) (The computer does not recognize your "WALKMAN"). (Continued)	<ul style="list-style-type: none"> When you use your "WALKMAN" for the first time, or when the battery is low, it may take your "WALKMAN" about 30 seconds to display the message after connected to a computer. This is not a malfunction. The software authentication may be performed and it may take rather a long time. Wait for a while. The software installation has been failed. <ul style="list-style-type: none"> → Reinstall the software by using the installer. The imported data will remain untouched. The computer is running another software other than the one used for transferring. <ul style="list-style-type: none"> → Disconnect the USB cable, wait a few minutes, and reconnect it. If the problem persists, disconnect the USB cable, restart the computer, and then reconnect the USB cable.
Your "WALKMAN" becomes unstable while it is connected to the computer.	<ul style="list-style-type: none"> A USB hub or USB extension cable is being used. <ul style="list-style-type: none"> → Connecting your "WALKMAN" via a USB hub or extension cable may not work. Connect your "WALKMAN" directly to your computer using the USB cable (supplied).
When double-clicking [Setup.exe] to install the bundled software, [Setup.exe] does not execute, and the Properties window opens.	<ul style="list-style-type: none"> Install the bundled software after installing Windows Media Player 11 or later. For details on Windows Media Player, refer to the following web site: http://support.microsoft.com/

To initialize (format) your "WALKMAN"

You can format the built-in flash memory of your "WALKMAN." If the memory is formatted, all files including the User Guide (HTML document) will be erased and all setting values returned to their defaults. Be sure to verify the files stored in memory prior to formatting, and then export any necessary files to the hard disk of your computer or other device beforehand.

- Press the HOME button to display the Home menu.
- Select [Settings] – [Common Settings] – [Reset/Format] – [Format] – [Yes] – [Yes] in this order. When initialization finishes, [Memory formatted.] appears.

Note

- Do not format the built-in flash memory using Windows Explorer. If you format the built-in flash memory, format it on your "WALKMAN."

Precautions

About the headphones

- Avoid playing the unit at so loud a volume that extended play might affect your hearing.
- At a high volume outside sounds may become inaudible. Avoid listening to the unit in situations where hearing must not be impaired, for example, while driving or cycling.

License and Trademark Notice

Refer to the User Guide (HTML document).

Excessive sound pressure from earphones and headphones can cause hearing loss.

Do not expose the batteries (battery pack or batteries installed) to excessive heat such as sunshine, fire or the like for a long time.

Rated current consumption 500 mA

For users in France

When replacing the headphones/earphones, please refer to the model of the headphones/earphones adapted to your unit that appears below.
MDR-EX0300

At high volume, prolonged listening to the personal audio player can damage the user's hearing.

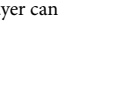

Owner's Record

The model and serial numbers are located on the back of the player. Record them in the space provided below. Refer to these numbers in the spaces whenever you call upon your Sony dealer regarding this product.

Model No. _____

Serial No. _____



Hereby, Sony Corp., declares that this equipment is in compliance with the essential requirements and other relevant provisions of Directive 1999/5/EC.

For details, please access the following URL:

<http://www.compliance.sony.de/>

Norway

Use of this radio equipment is not allowed in the geographical area within a radius of 20 km from the centre of Ny-Alesund, Svalbard.

For the latest information

If you have any questions or issues with this product, or would like information on compatible items with this product, visit the following web sites.

For customers in the USA:

<http://www.sony.com/walkmansupport>

For customers in Canada:

<http://www.sony.ca/ElectronicsSupport/>

For customers in Europe:

<http://support.sony-europe.com/DNA>

For customers in Latin America:

<http://www.sony-latin.com/index.crp>

For customers in other countries/regions:

<http://www.sony-asia.com/support>

For customers who purchased the overseas models:

<http://www.sony.co.jp/overseas/support/>