

# **POWERMATIC®**

## **Operating Instructions and Parts Manual Dual Drum Sander**

Model: DDS-225, DDS-237



**WMH TOOL GROUP**  
2420 Vantage Drive  
Elgin, Illinois 60123  
Ph.: 800-274-6848  
[www.wmhtoolgroup.com](http://www.wmhtoolgroup.com)

**Part No. M-0460278**  
Revision D1 04/07  
Copyright © 2007 WMH Tool Group, Inc.

# Warranty and Service





WMH Tool Group, Inc., warrants every product it sells. If one of our tools needs service or repair, one of our Authorized Service Centers located throughout the United States can give you quick service. In most cases, any of these WMH Tool Group Authorized Service Centers can authorize warranty repair, assist you in obtaining parts, or perform routine maintenance and major repair on your POWERMATIC® tools. For the name of an Authorized Service Center in your area call 1-800-274-6848.

## MORE INFORMATION

WMH Tool Group is consistently adding new products to the line. For complete, up-to-date product information, check with your local WMH Tool Group distributor, or visit [powermatic.com](http://powermatic.com).

## WARRANTY

POWERMATIC products carry a limited warranty which varies in duration based upon the product.

<p><b>Industrial Products</b></p>  <p><b>1 YEAR WARRANTY</b></p> <p><b>One Year Standard, option available on select POWERMATIC machines</b></p>  <p><b>2 YEAR WARRANTY</b></p> <p>Bandsaws Dust Collectors Jointers Boring Machines Dovetail Machines Planers Sanders</p> <p>Shapers Rip Saws Cut-off Saws Tablesaws Scoring Saws Panel Saws Accessories &amp; Abrasives</p> <p>Brush Sanders Dovetail Machines Drill Presses Drum Sanders Panel Saws Power Feeders Commercial use of Non-Industrial Products</p>	<p><b>Industrial Products</b></p>  <p><b>2 YEAR WARRANTY</b></p> <p><b>Two Year Option Available</b> on select industrial machines with distributor installation. See your POWERMATIC Industrial Distributor for details.</p>	<p><b>Non-Industrial Products</b></p>  <p><b>5 YEAR WARRANTY</b></p> <p>Visit our distributors or our website for more information.</p> <p><i>Warranty reverts to 1 Year if above products are used for commercial, industrial or educational purposes</i></p>
--	---	---

## WHAT IS COVERED?

This warranty covers any defects in workmanship or materials subject to the exceptions stated below. Cutting tools, abrasives and other consumables are excluded from warranty coverage.

## WHO IS COVERED?

This warranty covers only the initial purchaser of the product.

## WHAT IS THE PERIOD OF COVERAGE?

The general POWERMATIC warranty lasts for the time period specified in the product literature of each product.

## WHAT IS NOT COVERED?

The Five Year Warranty does not cover products used for commercial, industrial or educational purposes. Products with a Five Year Warranty that are used for commercial, industrial or education purposes revert to a One Year Warranty. This warranty does not cover defects due directly or indirectly to misuse, abuse, negligence or accidents, normal wear-and-tear, improper repair or alterations, or lack of maintenance.

## HOW TO GET SERVICE

The product or part must be returned for examination, postage prepaid, to a location designated by us. For the name of the location nearest you, please call 1-800-274-6848.

You must provide proof of initial purchase date and an explanation of the complaint must accompany the merchandise. If our inspection discloses a defect, we will repair or replace the product, or refund the purchase price, at our option.

We will return the repaired product or replacement at our expense unless it is determined by us that there is no defect, or that the defect resulted from causes not within the scope of our warranty in which case we will, at your direction, dispose of or return the product. In the event you choose to have the product returned, you will be responsible for the handling and shipping costs of the return.

## HOW STATE LAW APPLIES

This warranty gives you specific legal rights; you may also have other rights which vary from state to state.

## LIMITATIONS ON THIS WARRANTY

WMH TOOL GROUP LIMITS ALL IMPLIED WARRANTIES TO THE PERIOD OF THE LIMITED WARRANTY FOR EACH PRODUCT. EXCEPT AS STATED HEREIN, ANY IMPLIED WARRANTIES OR MERCHANTABILITY AND FITNESS ARE EXCLUDED. SOME STATES DO NOT ALLOW LIMITATIONS ON HOW LONG THE IMPLIED WARRANTY LASTS, SO THE ABOVE LIMITATION MAY NOT APPLY TO YOU.

WMH TOOL GROUP SHALL IN NO EVENT BE LIABLE FOR DEATH, INJURIES TO PERSONS OR PROPERTY, OR FOR INCIDENTAL, CONTINGENT, SPECIAL, OR CONSEQUENTIAL DAMAGES ARISING FROM THE USE OF OUR PRODUCTS. SOME STATES DO NOT ALLOW THE EXCLUSION OR LIMITATION OF INCIDENTAL OR CONSEQUENTIAL DAMAGES, SO THE ABOVE LIMITATION OR EXCLUSION MAY NOT APPLY TO YOU.

WMH Tool Group sells through distributors only. The specifications in WMH catalogs are given as general information and are not binding. Members of WMH Tool Group reserve the right to effect at any time, without prior notice, those alterations to parts, fittings, and accessory equipment which they may deem necessary for any reason whatsoever.

# Table of Contents

Warranty and Service.....	2
Table of Contents .....	3
Warnings .....	4
Features .....	6
Specifications .....	6
Unpacking .....	7
Shipping Contents .....	7
Assembly.....	8
Handwheel Assembly .....	8
Dust Ports .....	8
Dust Collection .....	8
Electrical Connections.....	8
Abrasive Paper Installation .....	9
Adjustments .....	10
Drum Height .....	10
Pressure Rollers .....	11
Table Height .....	11
Table Parallelism .....	11
Lead Screw Thread Clearance.....	12
Conveyor Belt .....	13
Drive Belts .....	13
Pulley Alignment.....	14
Changing Belts .....	14
Maintenance.....	15
Operations.....	15
Basic Operation .....	15
Stock Feeding Angle .....	15
Multiple-Piece Sanding Runs .....	16
Edge Sanding .....	16
Sanding Imperfect Stock .....	16
Face Frames & Raised Panel Doors.....	16
Reversing Conveyor Direction.....	16
Abrasives.....	16
Maintenance Checklist.....	18
Troubleshooting .....	18
Performance Problems.....	18
Mechanical & Electrical Problems .....	19
Parts – DDS-225 Sander .....	20
Drum Assembly – DDS-225 .....	20
Conveyor Assembly – DDS-225.....	22
Motor & Cabinet Assembly – DDS-225 .....	24
Gearbox Assembly – DDS-225 Drum .....	27
Parts – DDS-237 Sander .....	29
Drum Assembly – DDS-237 .....	29
Conveyor Assembly – DDS-237.....	31
Motor and Cabinet Assembly – DDS-237 .....	33
Gearbox Assembly – DDS-237 .....	36
Optional Accessories .....	38
Ready-To-Cut Abrasive Strips.....	38
Other Accessories .....	38
Wiring Diagram .....	39



# Warnings

1. Read and understand the entire owner's manual before attempting assembly or operation.
2. Read and understand the warnings posted on the machine and in this manual. Failure to comply with all of these warnings may cause serious injury.
3. Replace the warning labels if they become obscured or removed.
4. This drum sander is designed and intended for use by properly trained and experienced personnel only. If you are not familiar with the proper and safe operation of a drum sander, do not use until proper training and knowledge have been obtained.
5. As with all machines, there is a certain amount of hazard involved with the use of this drum sander. Use the machine with the respect and caution demanded where safety precautions are concerned. When normal safety precautions are overlooked or ignored, personal injury to the operator can result.
6. Do not use this drum sander for other than its intended use. If used for other purposes, WMH Tool Group disclaims any real or implied warranty and holds itself harmless from any injury that may result from that use.
7. Always wear approved safety glasses/face shields while using this drum sander. Everyday eyeglasses only have impact resistant lenses; they are not safety glasses.
8. Before operating this drum sander, remove tie, rings, watches and other jewelry, and roll sleeves up past the elbows. Remove all loose clothing and confine long hair. Non-slip footwear or anti-skid floor strips are recommended. Do **not** wear gloves.
9. Wear ear protectors (plugs or muffs) during extended periods of operation.
10. Some dust created by power sanding, sawing, grinding, drilling and other construction activities contain chemicals known to cause cancer, birth defects or other reproductive harm. Some examples of these chemicals are:
  - Lead from lead based paint.
  - Crystalline silica from bricks, cement and other masonry products.
  - Arsenic and chromium from chemically treated lumber.Your risk of exposure varies, depending on how often you do this type of work. To reduce your exposure to these chemicals, work in a well-ventilated area and work with approved safety equipment, such as face or dust masks that are specifically designed to filter out microscopic particles.
11. Do not operate this machine while tired or under the influence of drugs, alcohol or any medication.
12. Make certain the machine is properly grounded.
13. Except for the feed rate control, make all machine adjustments or maintenance with the machine unplugged from the power source. A machine under repair should be RED TAGGED to show it must not be used until maintenance is complete.
14. Before turning on machine, remove all extra equipment such as keys, wrenches, scrap, and cleaning rags away from the machine.
15. Keep safety guards in place at all times when the machine is in use. If removed for maintenance purposes, use extreme caution and replace the guards immediately.
16. Check damaged parts. Before further use of the machine, a guard or other part that is damaged should be carefully checked to determine that it will operate properly and perform its intended function. Check for alignment of moving parts, binding of moving parts, breakage of parts, mounting and any other conditions that may affect its operation. A guard or other part that is damaged should be properly repaired or replaced.
17. Provide for adequate space surrounding work area and non-glare, overhead lighting.

# Warnings

18. Keep the floor around the machine clean and free of scrap material, saw dust, oil and other liquids to minimize the danger of tripping or slipping. Be sure the conveyor table is free of all scrap, foreign material and tools before starting sanding operations.
19. Keep visitors a safe distance from the work area. Keep children away.
20. Make your workshop child proof with padlocks, master switches or by removing safety keys.
21. Give your work undivided attention. Looking around, carrying on a conversation and “horse-play” are careless acts that can result in serious injury.
22. Maintain a balanced stance at all times so that you do not fall or lean against the blade or other moving parts. Do not overreach or use excessive force to perform any machine operation.
23. Use the right tool at the correct speed and feed rate. Do not force a tool or attachment to do a job for which it was not designed. The right tool will do the job better and safer.
24. Use recommended accessories; improper accessories may be hazardous.
25. Maintain tools in top condition. Keep tools sharp and clean for safe and best performance. Dull tools increase noise levels and can cause kickbacks and glazed surfaces. Check the condition and adjustment of the tools before making any cuts.
26. Keep hands outside the machine. NEVER reach under the guards to try to clear stock that stops feeding. Do not clear chips and sawdust with hands; use a brush. Do not have any part of the hands under that part of the board that is over the table when starting a cut; the pressure roller will engage the board and force it down against the table causing a pinching action.
27. Do not attempt to sand boards with loose knots or with nails or other foreign material, on its surface. Do not attempt to sand twisted, warped, bowed or “in wind” stock unless one edge has been jointed for guiding purposes prior to sawing.
28. Do not attempt to sand long or wide boards unsupported where spring or weight could cause the board to shift position.
29. If the operator leaves the machine area for any reason, the sander should be turned "off" and come to a complete stop before his departure. In addition, if the operation is complete, he should clean the sander and the work area. NEVER clean the machine with power "on" and never use the hands to clear sawdust and debris; use a brush.
30. Turn off the machine before cleaning. Use a brush or compressed air to remove chips or debris — do not use your hands.
31. Do not stand on the machine. Serious injury could occur if the machine tips over.
32. Never leave the machine running unattended. Turn the power off and do not leave the machine until it comes to a complete stop.
33. Remove loose items and unnecessary work pieces from the area before starting the machine.

**Familiarize yourself with the following safety notices used in this manual:**

**CAUTION** This means that if precautions are not heeded, it may result in minor injury and/or possible machine damage.

**WARNING** This means that if precautions are not heeded, it may result in serious injury or possibly even death.

# Features

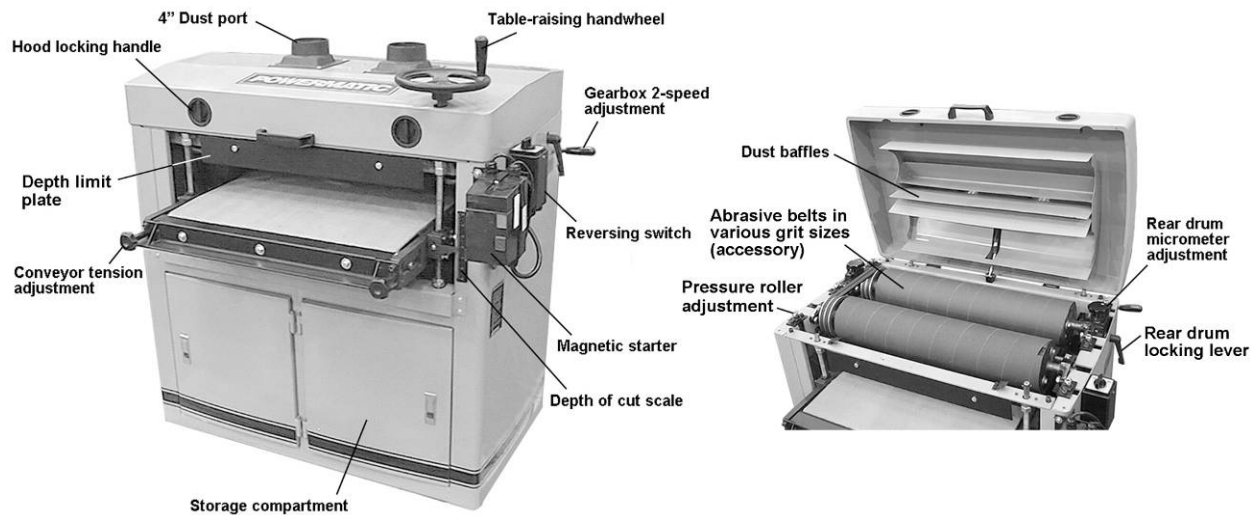

# Specifications

Model Number.....	DDS-225 .....	DDS-237 .....	DDS-237 .....
Stock Number .....	1791290 .....	1791320 .....	1791321 .....
Main Motor .....	see below .....	see below .....	see below .....
Main Motor Speed (RPM) .....	1,725 .....	1,725 .....	1,725 .....
Electrical Controls .....	see below .....	see below .....	see below .....
Conveyor Motor.....	see below .....	see below .....	see below .....
Conveyor Speed (SFPM).....	8 and 12 .....	8 and 12 .....	8 and 12 .....
Sanding Drum Diameter (in) .....	6 .....	6 .....	6 .....
Drum Length (in) .....	25 .....	37 .....	37 .....
Drum Speed (RPM).....	1,700 .....	1,700 .....	1,700 .....
Maximum Board Width (in).....	25 .....	37 .....	37 .....
Maximum Board Thickness (in).....	5-1/4 .....	5-1/4 .....	5-1/4 .....
Minimum Board Length (in).....	9 .....	9 .....	9 .....
Minimum Board Thickness (in) .....	1/32 .....	1/32 .....	1/32 .....
Dust Port Diameter.....	two @ 4\" .....	two @ 4\" .....	two @ 4\" .....
Dust Collection Capacity Required (CFM) .....	1200 .....	1,200 .....	1,200 .....
Shipping Weight (lbs).....	840 .....	1,142 .....	1,142 .....
Net Weight (lbs) .....	730 .....	962 .....	962 .....
Overall Dimensions (L x W x H).....	43 x 44 x 43 .....	60 x 45 x 45 .....	60 x 45 x 45 .....

### Main Motor

S/N 1791290 .....	(TEFC) 5HP, 1Ph, 230V, 60Hz
S/N 1791320 .....	(TEFC) 7.5HP, 1Ph, 230V, 60Hz
S/N 1791321 .....	(TEFC) 10HP, 3Ph, 230/460V (prewired 230V), 60Hz

### Conveyor Motor

S/N 1791290 .....	(TEFC) 1/4HP, 1Ph, 230V, 60Hz
S/N 1791320 .....	(TEFC) 1/4HP, 1Ph, 230V, 60Hz
S/N 1791321 .....	(TEFC) 1/4HP, 3Ph, 230/460V (prewired 230V), 60Hz

Electrical Controls (all models)..... 230V magnetic w/ reversing switch

The specifications in this manual are given as general information and are not binding. WMH Tool Group reserves the right to effect, at any time and without prior notice, changes or alterations to parts, fittings, and accessory equipment deemed necessary for any reason whatsoever.

# Unpacking

Open the shipping crate and check for shipping damage. Report any damage immediately. Read the owner's manual thoroughly for assembly, maintenance and safety instructions.

## Shipping Contents

**Note 1:** Some parts are inside a box in the cabinet.

**Note 2:** Models DDS-225 and DDS-237 Drum Sanders come from the factory with the first set of abrasive strips installed with 80 grit sandpaper on the front drum and 100 grit on the rear drum.

- 1 dual drum sander
- 1 handwheel
- 1 handle assembly
- 1 handwheel post
- 2 dust ports
- 2 open end wrenches (12-14mm and 17-19mm)
- 4 hex wrenches (2, 3, 4, and 5mm)
- 1 manual
- 1 warranty card

Installation and Assembly

### *Tools needed*

- 1 forklift or hoist with straps
- 1 14mm open-end wrench (provided)
- 1 cross-point screwdriver
- 1 flat head screwdriver
- 1 set of hex wrenches (provided)

Remove the screws holding the sander to the pallet and use a forklift or hoist to lift the sander off the pallet. DO NOT lift directly under the drums or rollers, as it may damage them.

The sander should be placed in a well-lit area with a sturdy floor and good ventilation. Leave enough space around the machine for loading and off-loading stock and general maintenance work.

Exposed metal surfaces, such as the shafts on the drums and pressure rollers, have been given a protective coating at the factory. This should be removed with a soft cloth moistened with kerosene. Do not use acetone, gasoline, or lacquer thinner for this purpose. Do not use solvents on plastic parts, and do not use an abrasive pad because it may scratch the surfaces.

# Assembly

## Handwheel Assembly

1. Slide the post up into the handwheel and secure with the set screws, as shown in Fig 1.
2. Use a flat head screwdriver to screw the bolt of the handle as far as it will go into the threaded hole of the handwheel, then tighten the hex nut down against the handwheel (Fig. 1).

The handle must rotate freely after tightening the hex nut. If the handle is too tight, loosen the hex nut and back out the bolt slightly, then re-tighten the hex nut.

3. The handwheel assembly, used for raising and lowering the conveyor table, is designed to be mounted and removed quickly. Set the handwheel assembly down into the hole of the hood (Fig. 2) and rotate it until it seats itself upon the pins of the leadscrew below.

**Note:** The handwheel must be removed before the hood can be opened.

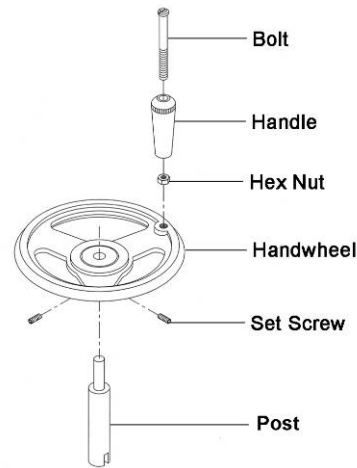

Figure 1

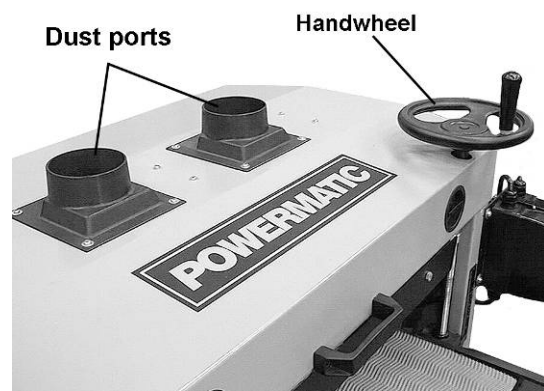

Figure 2

## Dust Ports

Mount the two dust ports to the top of the hood with eight 3/16 x 1/2 screws and eight flat washers (Fig. 2).

## Dust Collection

It is strongly recommended that you connect a proper dust extraction system to the two 4" ports atop the sander. Make sure the capacity of your dust collector is at least 1200 CFM.

## Electrical Connections

**⚠️WARNING** Electrical connections must be made by a qualified electrician in compliance with all relevant codes. The machine must be properly grounded to help prevent electrical shock and possible fatal injury.

A power plug is not provided with the DDS-225 or DDS-237 Dual Drum Sander. You may either connect the proper UL/CSA listed plug or "hardwire" the machine directly to your electrical panel provided there is a disconnect near the machine for the operator. Consult electrical drawings on pages 39-42 for further clarification of wiring setup.

This machine must be grounded. Grounding provides a path of least resistance to help divert current away from the operator in case of electrical malfunction. The green wire is the grounding wire.

Make sure the voltage of your power supply matches the specifications on the motor plate of the machine.

### Extension Cords

The use of an extension cord is not recommended, but if one is necessary, make sure the cord rating is suitable for the amperage listed on the machine's motor plate. An undersize cord will cause a drop in line voltage resulting in loss of power and overheating.

The chart in Table 1 shows the correct size cord to use based on cord length and motor plate amp rating. If in doubt, use the next heavier gauge. The smaller the gauge number, the heavier the cord.

Rated amps	Length of cord		
	25 ft.	50 ft.	100 ft.
0-6	18	16	16
7-10	18	16	14
11-12	16	16	14
13-16	14	12	12
17-20	12	12	10
21-30	10	10	Not recommended

Table 1



# Abrasive Paper Installation

**⚠WARNING** Disconnect machine from power source.

Proper attachment of the abrasive strips to the drums is important for achieving top performance from the sander.

See page 38 for a list of available abrasive strips with their respective grits and some tips on choosing the proper strip for a particular job. If using different size grits simultaneously, always place the coarser grit on the front drum.

Attach the abrasive paper as follows:

1. Open the hood by removing the handwheel and turning the two locking handles at the front counterclockwise.

2. Remove the socket head cap screw and locking wedge (Fig. 3) from both ends of the drum.

**Note:** If the wedge sticks, use a flat head screwdriver as leverage to free it.

3. Cut a length of the *Ready-To-Cut* abrasive strip (12' for the DDS-225, 16' 5" for the DDS-237). This will be enough to cover one drum.

**Note:** The taper on the remaining roll can later be used for the starting edge of your next strip.

4. Mark and cut a taper at the right end of the abrasive strip (Fig. 4). Because the tapered end should use all of the recess at the right side of the drum, its end must be trimmed back leaving an edge of about 1/2 inch, as shown. Now trim the left side of the abrasive paper in a similar manner (Fig. 5).

**Note:** An alternate method of tapering the ends of the abrasive strip is to place the removed sandpaper strip on top of the new strip and to use this as a template.

5. Begin at the right end of the drum and tuck the tapered right end of the abrasive roll into the recess (Fig. 3). Place the locking wedge into the recess and tighten firmly with the socket head cap screw.

6. Begin wrapping the strip around the drum, keeping it taut as you go. The tapered cut of the strip should follow the right edge of the drum. Continue to wrap the abrasive in a clockwise spiral fashion by rotating the drum with your left hand and guiding the strip with your right hand (Fig. 6). Successive windings of the strip should be flush with previous windings without any overlap.

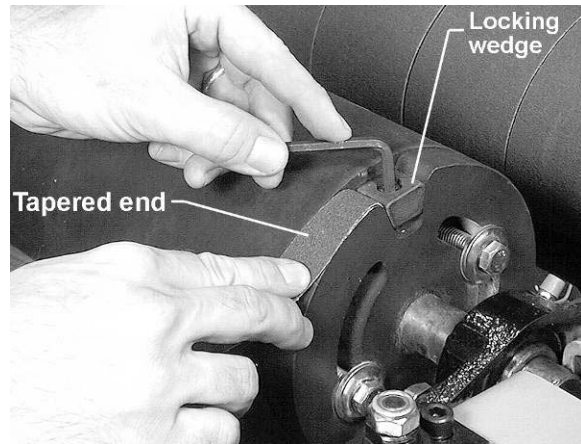

Figure 3

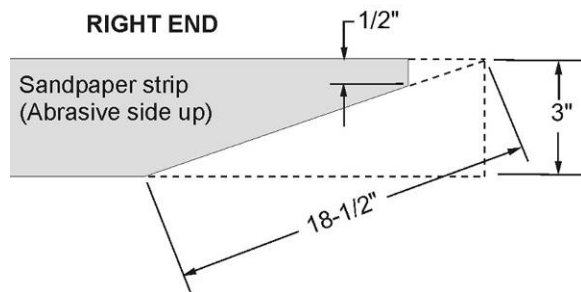

Figure 4

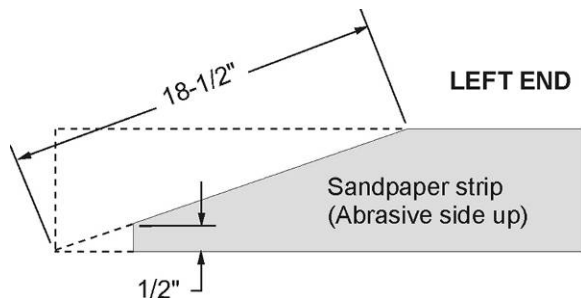

Figure 5

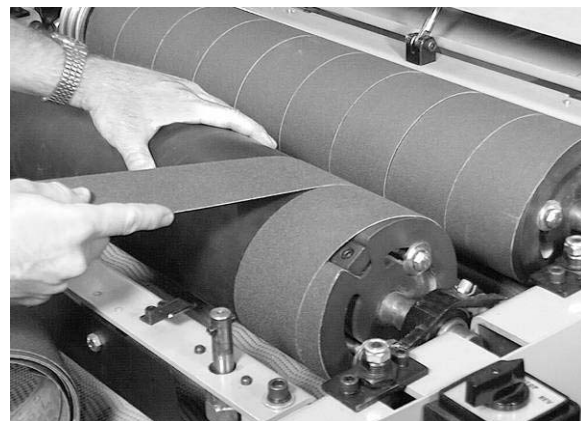

Figure 6

7. The left end of the drum which contains the recess is an independent piece (Fig. 7) that can be rotated on the drum. This fastener is spring-tensioned to take up any slack and hold the abrasive strip firmly to the drum. Rotate this fastener backward and hold it there with your thumb as shown in Fig. 7.
8. Tuck the tapered left end of the strip into the recess, as shown in Fig. 7, then insert the locking wedge and socket head cap screw, tightening the screw until the locking wedge is firmly seated.
9. Release the spring-tensioned fastener. The abrasive strip is now ready for use.
10. Repeat this procedure for the other drum.

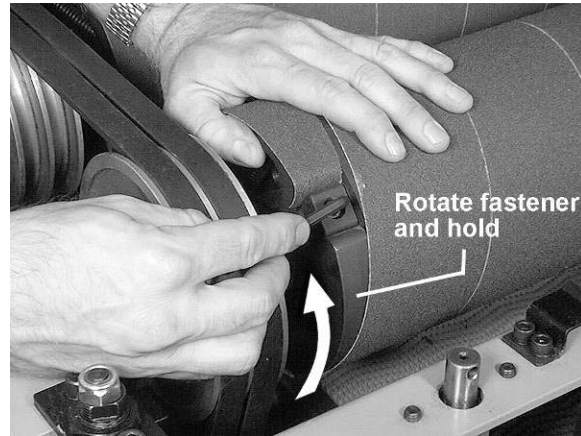

Figure 7

## Adjustments

### Drum Height

When using different abrasive grits on the drums, the height of the drums from the workpiece must vary. To achieve this, the back drum (which should always have the finer grit) has been designed for easy adjustment.

1. Loosen the locking levers (Fig. 8) on both sides of the machine by rotating them counter-clockwise.
2. Rotate the adjustment knob to the desired measurement, using the red triangular indicator at the base of the dial. A label is affixed below the locking lever showing the proper settings. It is also shown in Fig. 9.
3. Repeat this dial setting on the opposite end of the drum.

**Note:** It is important that the dial setting be identical at both ends of the drum.

4. Tighten the locking levers (Fig. 8) by rotating clockwise, before operating the sander.

**Note:** The locking levers are spring loaded – you can move the handle to any position by pulling out on the lever, rotating it on the hub, then releasing.

**Important:** After changing abrasive strips, always check and, if necessary, reset the back drum height.

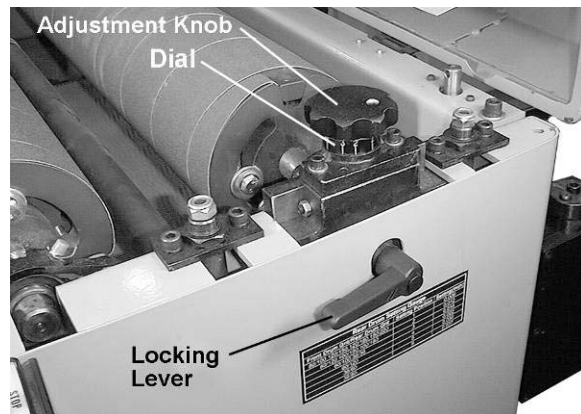

Figure 8

Rear Drum Setting Gauge		
Front Drum Grit / Rear Drum Grit	Setting Position	Setting (Inch)
80/100, 120/150, 120/180, 150/220	1	0.006
80/120, 100/150, 100/180	2	0.012
60/100, 36/38	3	0.016
36/120	4	0.022
36/60	5	0.030
36/80	6	0.037

Figure 9

## Pressure Rollers

The pressure rollers (Fig. 10) maintain tension upon the workpiece as it passes through the machine. The spring tension of the pressure rollers has been factory set. If a board refuses to pass through the machine, or the finished surface of a board is uneven, the spring tension of the pressure rollers may need adjusting.

1. Loosen the hex nut (A, Fig. 10).
2. Place a 17mm wrench over the flat on the adjusting screw (B, Fig. 10) and lower the screw to increase the roller pressure on the workpiece; or raise the screw to decrease the pressure.
3. Retighten hex nut (A, Fig. 10).
4. Repeat this same adjustment at the opposite end of the roller to maintain parallel.
5. Repeat procedure for other two pressure rollers.

**CAUTION** Do not over tighten the adjusting screw, as excess roller pressure will prevent the workpiece from passing through the machine, and may cause the conveyor belt to stop.

## Table Height

Rotate the handwheel until the depth gauge (Fig. 11) reads the appropriate depth. One revolution of the handwheel moves the table approximately 1/16".

A limit plate (Fig. 11) is mounted to the front of the sander. If the table has been set too high, the workpiece will contact this plate and a limit switch will shut off the conveyor table. If this happens, reposition the table and restart the machine.

## Table Parallelism

The conveyor table has been set parallel to the drums at the factory. If the conveyor table should ever need adjusting to bring it back into parallel with the drums, proceed as follows:

1. Remove the front cover plate below the table to expose the chain. Also remove the rear cover plate.
2. Loosen the socket head cap screw on the chain tensioner (Fig. 12) and slide the chain tensioner assembly forward to slacken the chain.
3. Remove the chain from around all four sprockets.

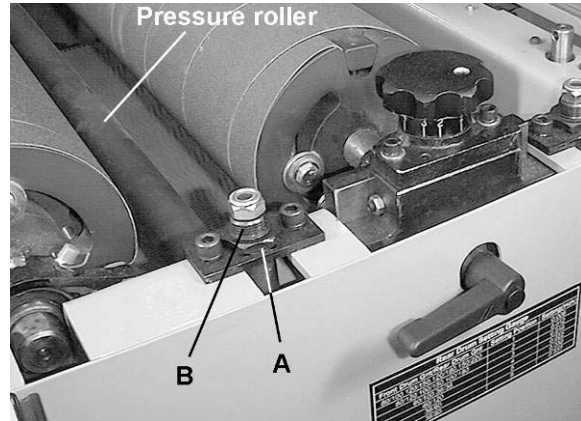

Figure 10

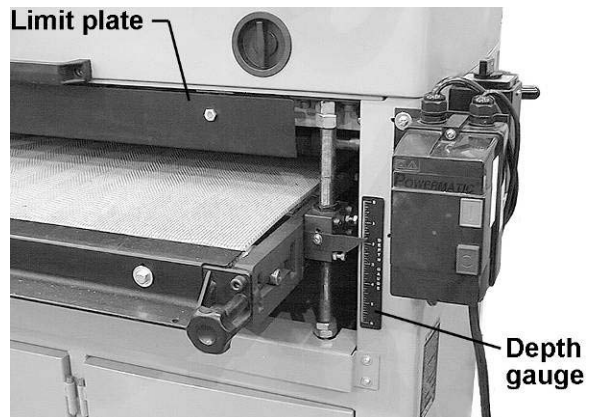

Figure 11

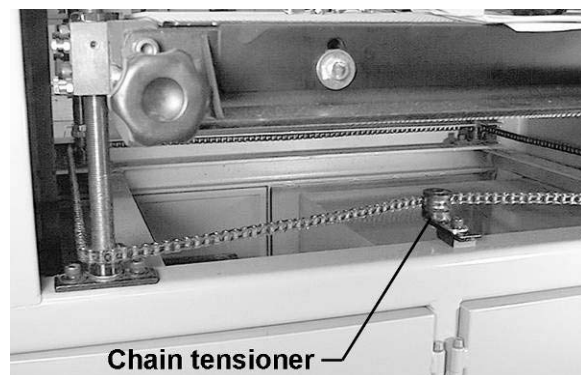

Figure 12

4. Insert a tool, such as a hex wrench or screwdriver, through the hole on top of the leadscrew (Fig 13) at that corner of the table that is lowest.
5. Turn the leadscrew clockwise to raise the table.
6. When the adjustment is complete, install the chain over the four sprockets, and over the chain tensioner roller. Push back the chain tensioner assembly until proper tension is achieved, then tighten the socket head cap screw on the chain tensioner.
7. Install front and rear cover plates.

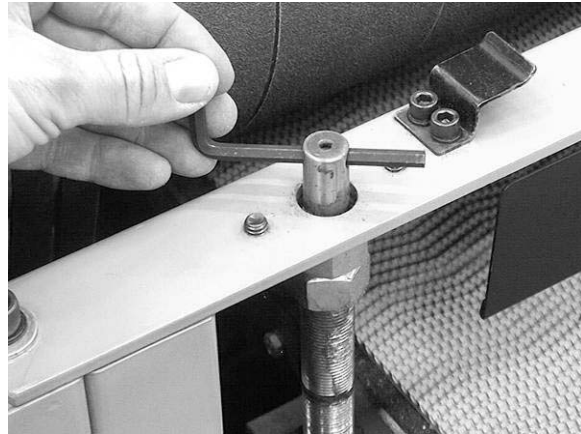

Figure 13

After this procedure, the pressure rollers should be checked and adjusted if necessary (see *Pressure Rollers* on page 11).

### Lead Screw Thread Clearance

Referring to Figure 14 – If adjusting the table height becomes difficult or if excessive clearance forms between the lead screws and bushings, adjustment may be required as described below.

#### *Symptoms*

- Table wobble is noted
- Difficulty is noted in table height adjustment

#### *Corrective action*

1. Determine the corner(s) requiring adjustment.
2. Use a 1/8" hex wrench to loosen the *setscrew* (A, Fig. 19) between 1/4 and 1/2 turn.

#### *To remove excessive clearance*

3. Using a 1-1/8" wrench, slightly tighten the *eccentric bushing* (B) by turning clockwise (from right to left).

#### *For clearance too tight, causing difficulty in table height adjustment*

3. Using a 1-1/8" wrench, slightly loosen the *eccentric bushing* (B) by turning counter-clockwise (from left to right).

#### *After adjustment*

4. Tighten the *setscrew* (A).

After adjusting the lead screw clearance, the table must be rechecked for parallelism (previous section).

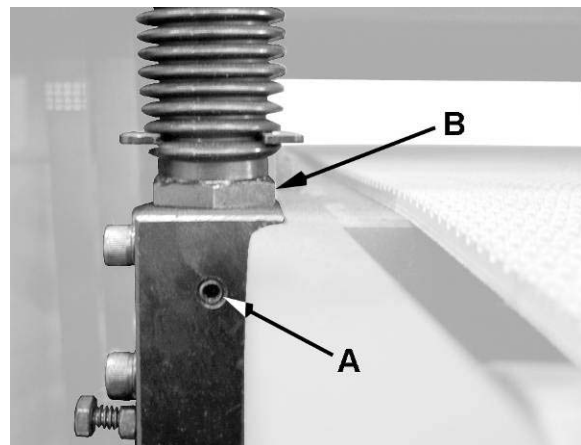

Figure 14

## Conveyor Belt

Conveyor belt tension and tracking adjustments may occasionally be necessary during break-in and normal operation to compensate for belt stretching. Adjust the tension of the conveyor belt by turning the knobs (Fig. 15) clockwise to increase tension, counterclockwise to decrease tension. The belt should have just enough tension to move the material without slipping on the drive roller.

**CAUTION** Do not over tighten the conveyor belt. Excessive tension will cause stretching and premature wear of the belt.

After tensioning the belt, turn on the machine and run the conveyor in the forward direction at the fastest speed setting. Watch for a tendency of the conveyor belt to drift to one side of the conveyor. If this happens, correct as follows:

1. On the side of the conveyor toward which the belt is drifting, tighten the knob 1/4 turn (Fig. 15) to shift the belt to the opposite direction.
2. On the side of the conveyor away from which the belt is drifting, loosen the knob.
3. After adjusting each take-up knob, allow time for the belt to react to the adjustments before proceeding further. Continue this adjustment until the conveyor belt is tracking properly in the center of the table. Try to avoid over-adjustments.



Figure 15

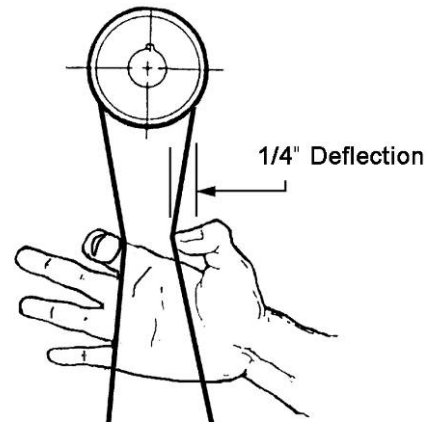

Figure 16

## Drive Belts

Check the tension of the drive belts by squeezing the belts together in the middle (between the motor and drum pulleys as shown in Fig. 16) with moderate pressure. They are properly tensioned when there is approximately 1/4" deflection.

If adjustment is necessary, loosen the hex nuts (Fig. 17) and raise or lower the motor plate as needed. (For example, to lower the motor plate and increase tension, loosen the bottom nuts and tighten the top nuts.) When finished, tighten the nuts.

If replacing the belts, always replace them in matched sets of the proper size.

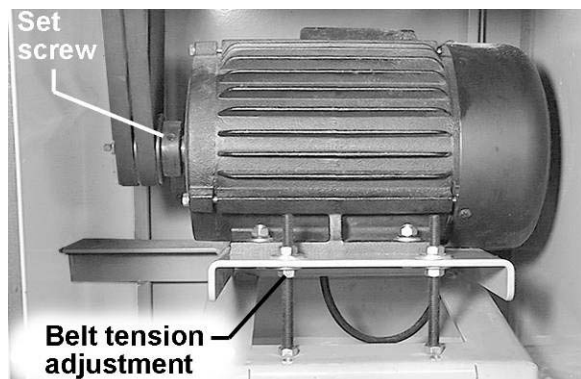

Figure 17

## Pulley Alignment

The drum and motor pulleys must be in line so that the belts are straight. To check this:

Place a straight edge, such as a metal ruler, against the flat sides of the motor pulley and a drum pulley (Fig. 18).

If the straight edge does not lie flush on the flat sides of the pulleys, loosen the set screw on the motor pulley (Fig. 17).

Move the motor pulley on the shaft until the straight edge lies flush on both pulleys.

Tighten the set screw.

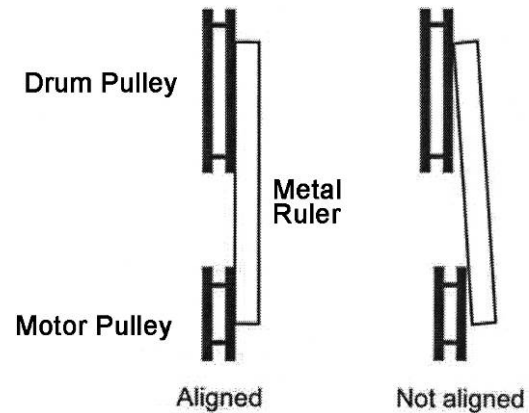

Figure 18

## Changing Belts

**CAUTION** The drums are heavy – use an assistant to change belts.

Adjust the motor to allow slack in the belts, and remove the two belts from around the motor pulley. Belts should always be replaced as a matched set.

Remove the four bolts holding the front drum to the sides of the cabinet, and lift the front drum out of the machine.

On the rear drum, loosen the two bolts at the right side of the drum, but do not remove them. Completely remove the two bolts that hold the left side of the drum to the cabinet, and shift the drum toward the right side. The left end of the drum should come clear of the cabinet.

Remove the old belts and place the new belts around the drum pulley. Reinsert the two bolts at the left end of the drum and tighten firmly.

Retighten the two bolts at the right side of the drum.

Check and adjust the tension of the new belts before operating.

## Maintenance

**Note:** See also *Maintenance Checklist* on page 18.

For best results, perform the following procedures on a routine basis:

- Grease the four leadscrews on the table.
- Lubricate the bushings at each end of the pressure rollers. Use a dry type lubricant for this, such as graphite or silicone that will not attract dust.
- Keep the chain below the table clean and oiled.
- With the machine on and the drums rotating, clean sawdust from the abrasive strips with a cleaning stick (Fig. 19). This item is available as an accessory (stock no. 57620025, JS-1 JET-Stick Belt Cleaner).

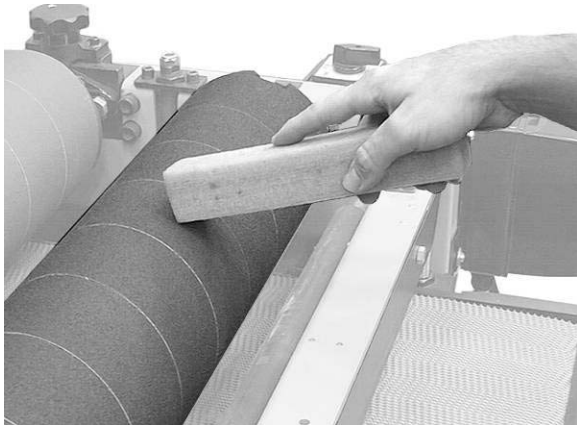

Figure 19

**CAUTION** Always use eye protection when performing sandpaper cleaning, and take precautions to avoid any contact of hands or clothing with uncovered drums.

- After cleaning, use a shop brush to remove any cleaning stick crumbs from the drums before resuming sanding operations.
- Blow dust from motors and switches.
- Check screws, nuts, etc. for tightness.
- Check the tension and condition of the belts; dress with paraffin. (Do not get paraffin on the abrasive belts.)
- Check the oil level in the gearbox by removing the oil plug on top, and add if necessary. Use a good quality gear oil. After every 2,500 hours, completely drain and refill gearbox.

## Operations

### Basic Operation

The basic operating procedure for the DDS-225 is as follows:

1. Set depth of cut.
2. Start drums.
3. Start conveyor and select feed rate.
4. Start dust collector system.
5. Feed stock through unit.

Determining depth of cut is one of the most important procedures for the sander. It may take some experimentation to determine the proper depth of cut, given the variables of abrasive grit, type of wood, and feed rate. For best results, use scrap wood to practice sanding and to develop skill and familiarity with the machine before doing finish work.

A good rule of thumb when sanding with grits finer than 80 is to lower the drum so it contacts the workpiece but drum can still be rotated by hand. When using grits coarser than 80 grit, you can lower the drum slightly more. However, a combination of several variables will determine the proper depth of cut to use, including the following:

- Abrasive type and grit size.
- Width of the piece being processed.
- Hardness of the piece.
- Feed rate of the conveyor belt.

### Stock Feeding Angle

Some pieces, because of their dimensions, will need to be fed into the machine at a 90° angle (perpendicular to the drums). However, even a slight offset angle of the stock will provide for more effective stock removal. The optimum feeding angle is about 60° (Fig. 20). Angling the workpiece for stock removal provides other advantages, such as less loading of certain areas of the drums due to glue lines or mineral streaks in the stock, more even wear of abrasive strips, potentially faster feed rates, and lighter loads on the motor.

Note, however, that to get the best final finish the stock should be fed through the machine so it will be sanded in line with the grain of the wood on the final one or two passes.

## Multiple-Piece Sanding Runs

When abrasive planing (or thickness sanding) a run of similar pieces that you want to have the same thickness, it is best to determine the thickness of the thinnest piece and process all pieces to that same thickness in one session. Be aware that the sander will remove cups and crowns in the workpiece; consider this when measuring and processing stock to the same thickness.

When sanding multiple pieces simultaneously, make sure to stagger (step) the pieces across the width of the conveyor belt. This provides better contact with the pressure rollers. Try to only process multiple pieces of similar thickness. If there is a significant thickness difference, the thinner pieces may slip on the conveyor belt if they do not contact the pressure rollers.

## Edge Sanding

When edge sanding, the sander will mimic the opposite edge of the stock which is lying on the conveyor belt. Because of this, it is important for the stock edge to have been ripped at the proper angle to the face before the sanding process. When edge sanding small stock, clamp several pieces together to prevent them from slipping on the conveyor belt.

## Sanding Imperfect Stock

When sanding stock with a cup or crown, place the crown up. This will stabilize the stock to help prevent tipping or rocking during sanding. (After the crown has been removed and the top is flat, turn the stock over and sand the opposite side.) To avoid personal injury, take special care when sanding stock that is twisted, bowed, or otherwise varies in thickness from end to end.

If possible, support such stock as it is being sanded to keep it from slipping or tipping. Use extra roller stands, help from another person, or hand pressure on the stock, to minimize potentially hazardous situations.



Figure 20

## Face Frames & Raised Panel Doors

It is important to have the proper abrasive contact when doing this type of sanding. If the machine is set to take an excessive depth of cut, the result can be a gouge or dip as the drum goes from sanding the rails at full width to sanding just a few inches of width of the stiles.

## Reversing Conveyor Direction

If a board becomes jammed under the rollers, back it out by reversing the conveyor direction, using the switch (Fig. 21). Do not perform sanding operations in reverse mode, as the drums rotate in one direction only.

**CAUTION** Allow the conveyor belt to come to a complete stop before reversing direction.



Figure 21

## Abrasives

The abrasive material you choose will have a substantial effect on the performance of your sander. Variations in paper type, weight, coating and durability all contribute to achieving your desired finish. Ready-To-Cut strips are available from WMH Tool Group and are listed on page 38.

As with any sanding operation, first begin sanding with a coarser grit, depending on the roughness of the stock or the amount of stock to be removed. Then progressively work toward finer grits. This means if you are using two different grits on your DDS-225 dual drum sander, the coarser grit should always be placed on the front drum.

The amount of stock to be removed is a major consideration when choosing the grit grade to start with. Grits 36 and 60 are primarily designed for stock removal; grits over 100 are primarily finishing grits designed to remove the scratch pattern from the previous grit used. For best



results, never skip more than one grit grade when progressing through a sanding sequence.

For fine work, such as furniture, try not to skip any grit grades during the sanding process. In general, premium quality abrasives will produce a better finish with a less noticeable scratch pattern.

**CAUTION** Grits that are too fine can sometimes burnish the wood and leave a glossy surface which will not accept stains evenly.

This will vary by type of wood. Oak, for example, is susceptible to burnishing because of its open pores.

**Cleaning abrasive strips.** Regularly clean the abrasive strips on the drums with commercially

available cleaning sticks, following the manufacturer's directions. When cleaning, also brush the stick crumbs from the drum while it is still rotating.

**CAUTION:** Wear tight fitting clothes and eye protection during this procedure; stay alert to prevent injury. Cloth backed abrasives can be cleaned by soaking in paint thinner or mineral spirits for 20 minutes to 1 hour, then using a brush to remove any build-up or burns. Dry the abrasive strips completely before reuse.

**Extending Abrasive Life.** Abrasive life can also be increased by removing the abrasive strip from the drum and reversing it. To do this, remove the strip and use what was the trailing end as the starting end on the right side of the drum. Reversing the strip will provide a fresh set of cutting edges on the abrasive.

# Maintenance Checklist

**Note:** See also the *Maintenance* section on page 15.

- Work area around machine marked off clearly.
- Non-skid floor strips in area where operator normally stands.
- Inspect entire machine for loose bolts, nuts, screws. Tighten and replace as necessary.
- Clean conveyor and drum areas, removing sawdust and chips with compressed air or a soft bristle brush. Remove gum and pitch from metal areas with oven cleaner.
- Lubricate chain and check tension.
- Check belt condition - replace as needed. Dress with paraffin. Check belt tension.
- Check motor for loose wiring and sawdust congestion.
- Pulleys tight and in line.
- Check bearings. Replace any bad or suspect bearings immediately.

## Troubleshooting

### Performance Problems

Problem	Possible Cause	Solution
Abrasive belt glazes	Wood is wet or gummy	No cure. Use different stock
Work burns	Wrong grit	Use coarser grit for stock removal
Abrasive belt burns, clogs quickly	Biting too deep	Adjust for slight sanding action and make repeated passes
Excessive abrasive belt replacement	Biting too deep	Reduce cut and make multiple passes
Sanding marks on workpiece	Abrasive belt too coarse for finish required Sanding across the grain	Use proper grit for finish sanding  When surface sanding, use very fine abrasive belt then finish by hand, working in direction of grain.
Poor sanding quality	Abrasive belts worn Abrasive belts not tight on drum	Replace abrasive belts Re-wrap and properly tighten abrasive belts.
A slight taper across the sanded face of the workpiece	Height of rear drum has not been adjusted evenly on both ends Conveyor table not parallel to drums	Make drum setting equal both ends Correct table parallelism
Conveyor table hard to move, or tends to bind on the leadscrews	Leadscrews not greased Table not parallel	Lubricate leadscrews Correct table parallelism

## Mechanical & Electrical Problems

**Problem:** Machine will not start, restart or repeatedly trips circuit breaker or blows fuses

Possible Cause	Solution
1. No incoming power	1. Verify unit is connected to power.
2. Overload automatic reset has not reset	2. When sander overloads on the circuit breaker built into the motor starter, it takes time for the machine to cool down before restart. Allow unit to adequately cool before attempting restart. If problem persists, check amp setting on the motor starter inside the electrical box.
3. Sander trips frequently	3. One cause of overloading trips which are not electrical in nature is too heavy a cut. The solution is to take a lighter cut. If too deep a cut is not the problem, then check the amp setting on the overload relay. Match the full load amps on the motor as noted on the motor plate. If amp setting is correct then there is probably a loose electrical lead. Check amp setting on the motor starter.
4. Building circuit breaker trips or fuse blows.	4. Verify that sander is on a circuit of correct size. If circuit size is correct, there is probably a loose electrical lead, Check amp settings on motor starter.
5. Loose electrical connections.	5. Go through all the electrical connections on the sander including motor connections, verifying the tightness of each. Look for any signs of electrical arcing which is a sure indicator of loose connections or circuit overload.
6. Motor starter failure	6. Examine motor starter for burned or failed components. If damage is found, replace motor starter. If motor starter looks okay but is still suspect, you have two options: have a qualified electrician test the motor starter for function, or purchase a new starter and establish if that was the problem on changeout. If you have access to a voltmeter, you can separate a starter failure from a motor failure by first, verifying incoming voltage at 220 +/- 20 VAC. If incoming voltage is incorrect, you have a power supply problem. If voltage between starter and motor is correct, you have a motor problem.
7. Motor failure	7. If electric motor is suspect, you have two options: Have a qualified electrocution test the motor for function or remove the motor and take it to a qualified electric motor repair shop and have it tested.
8. Miswiring of the unit.	8. Double check to confirm all electric connections are correct and properly tight. The electrical connections other than the motor are pre-assembled and tested at the factory. Therefore, the motor connections should be double checked as the highest probability of error. If problem persists, double check the factory wiring.
9. On/off switch failure	9. If the on/off switch is suspect, you have two options: Have a qualified electrician test the switch for function, or purchase a new on/off switch and establish if that was the problem on changeout.

# Parts – DDS-225 Sander

## Drum Assembly – DDS-225

Index No.	Part No.	Description	Size	Qty
1	DDS225-101	Rear Drum		1
2	DDS225-102	Abrasive Fastener-Right		2
3	DDS225-103	Abrasive Fastener-Left		2
4	DDS225-104	Spring		2
5	DDS225-105	Locking Wedge		4
6	TS-0561021	Hex Nut	5/16-18NC	4
7	DDS225-107	Support Bracket		2
8	DDS225-108	Pulley		2
9	DDS225-109	Tension Roller		3
10	DDS225-110	Bushing		6
11	DDS225-111	Spring		6
12	DDS225-112	Bracket		6
13	DDS225-113	Bearing Assembly	UCFL205	4
14	VB-B68	Belt		2
15	DDS225-115	Key	8 x 7 x 50	2
16	DDS225-116	Adjusting Bushing		6
17	TS-0561031	Hex Nut	3/8-16NC	20
18	TS-0051011	Hex Cap Screw	5/16-18 x 1/2	12
19	TS-0720081	Lock Washer	5/16	12
20	TS-0060071	Hex Cap Screw	3/8-16 x 1-1/2	8
21	DDS225-121	Hex Cap Screw	1/2-12 x 1-1/2	8
22	TS-0720111	Lock Washer	1/2	8
23	TS-0060011	Hex Cap Screw	3/8-16 x 1/2	4
24	TS-0720091	Lock Washer	3/8	16
25	TS-1550071	Flat Washer	M10	4
26	TS-0207061	Socket Head Cap Screw	1/4-20 x 1	4
27	TS-0270091	Socket Set Screw	5/16-18 x 1	4
28	TS-0060021	Hex Cap Screw	3/8-16 x 5/8	4
29	TS-0060051	Hex Cap Screw	3/8-16 x 1	2
30	TS-0208021	Socket Head Cap Screw	5/16-18 x 1/2	4
31	TS-0270051	Socket Set Screw	5/16-18 x 1/2	2
32	DDS225-132	Spring		2
33	DDS225-133	Steel Ball	Ø5mm	2
34	TS-0267021	Socket Set Screw	1/4-20 x 1/4	4
35	DDS225-135	Adjusting Knob		2
36	DDS225-136	Lead Screw		2
37	TS-0207041	Socket Head Cap Screw	1/4-20 x 3/4	4
38	DDS225-138	Roll Pin	Ø5 x 15mm	4
39	TS-0720071	Lock Washer	1/4	4
40	DDS225-140	Top Cover-Right		1
41	DDS225-141	Collar		2
42	DDS225-142	Slide		2
43	DDS225-143	Locking Lever		2
44	DDS225-144	Slide Bracket-Right		1
45	TS-0561011	Hex Nut	1/4-20NC	4
46	TS-0267091	Socket Set Screw	1/4-20 x 1	4
47	DDS225-147	Gib-Right		1
48	DDS225-148	Top Cover-Left		1
49	TS-1541041	Hex Nylon Lock Nut	M10	6
50	DDS225-150	Adjusting Screw		6
51	DDS225-151	Hex Nut	M22 x 1.5P x 5T	6
52	DDS225-152	Slide Bracket-Left		1
53	DDS225-153	Gib-Left		1

# Drum Assembly – DDS-225

Index No.	Part No.	Description	Size	Qty
54	DDS225-154	Front Drum		1
55	TS-1521021	Socket Set Screw	M4 x 6	4
56	DDS225-156	Roll Pin	Ø2 x 8mm	2
57		Abrasive (see <i>Optional Accessories</i> on page 38)		

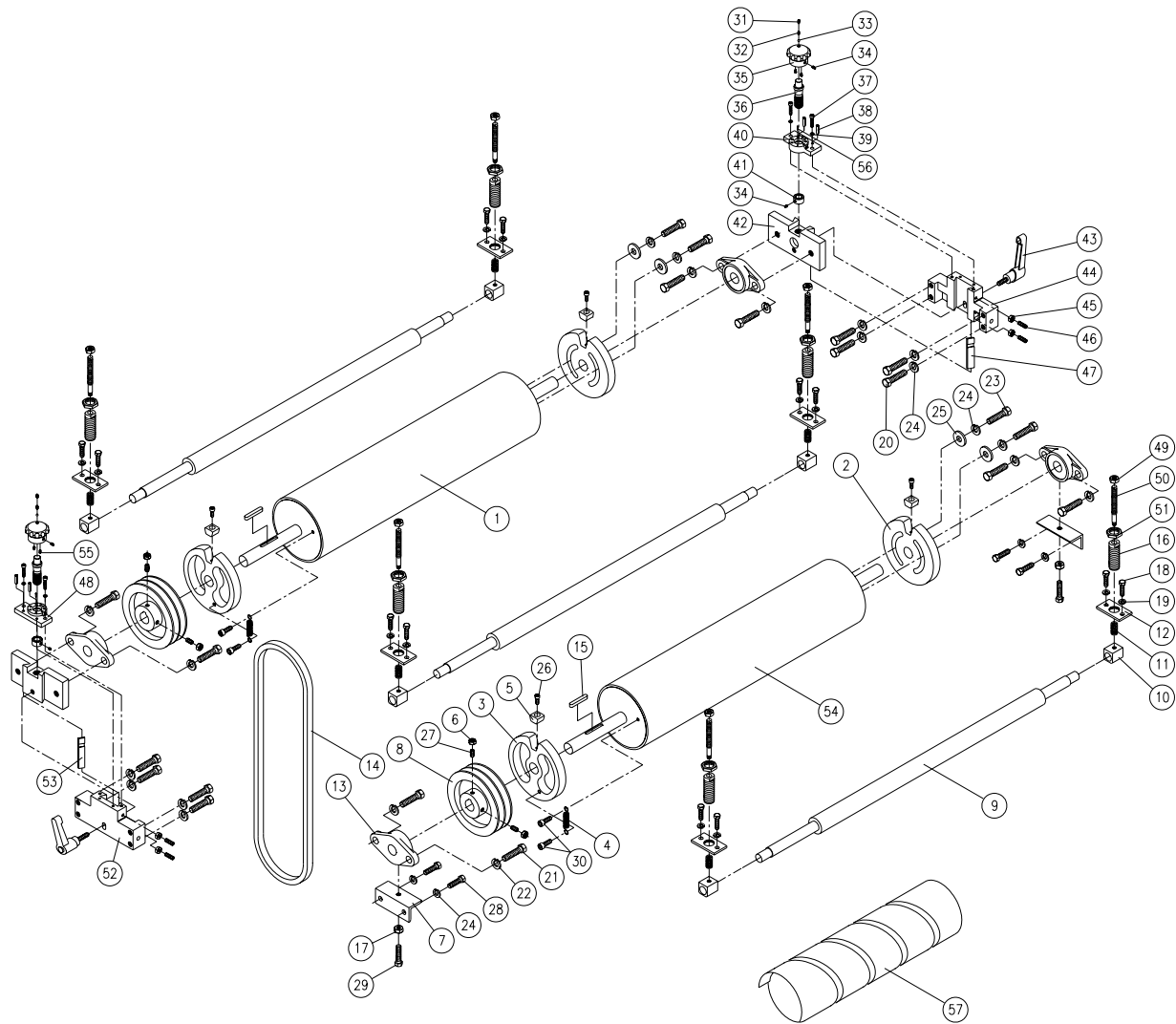

## Conveyor Assembly – DDS-225

Index No.	Part No.	Description	Size	Qty
1	DDS225-201	Table		1
2	DDS225-202	Support Bracket, Left-Front		1
3	DDS225-203	Support Bracket, Right-Front		1
4	DDS225-204	Support Bracket, Left-Rear		1
5	DDS225-205	Support Bracket, Right-Rear		1
6	DDS225-206	Leadscrew Holder, Right-Front		1
7	DDS225-207	Leadscrew Holder, Left-Front and Right-Rear		2
8	DDS225-208	Rod		1
9	DDS225-209	Front Roller		1
10	DDS225-210	Front Support Plate		1
11	DDS225-211	Collar		2
12	DDS225-212	Adjusting Knob		2
13	DDS225-213	Rear Roller		1
14	DDS225-214	Rear Support Plate		1
15	DDS225-215	Drive Leadscrew		1
16	DDS225-216	Driven Leadscrew		3
17	DDS225-217	Sprocket		4
18	DDS225-218	Support Bracket		8
19	DDS225-219	Guide Plate		2
20	DDS225-220	Post		1
21	DDS225-221	Handle		1
22	DDS225-222	Pointer		1
23	DDS225-223	Collar		2
24	DDS225-224	Bolt		1
25	BB-6203ZZ	Ball Bearing	6203ZZ	4
26	DDS225-226	Thrust Bearing		4
27	DDS225-227	Roll Pin	∅6 x 25mm	1
28	DDS225-228	Chain		1
29	TS-081F022	Phillips Pan Head Machine Screw	1/4-20 x 3/8	1
30	TS-0050011	Hex Cap Screw	1/4-20 x 1/2	8
31	TS-0207111	Socket Head Cap Screw	1/4-20 x 2-1/4	16
32	TS-0720071	Lock Washer	1/4	16
33	TS-0561082	Hex Nut	3/4-16UNF	8
34	DDS225-234	Key	5 x 5 x 18mm	4
35	TS-0208041	Socket Head Cap Screw	5/16-18 x 3/4	16
36	TS-0720081	Lock Washer	5/16	26
37	TS-0050081	Hex Cap Screw	1/4-20 x 1-3/4	8
38	TS-0561021	Hex Nut	5/16-18NC	10
39	TS-1550061	Flat Washer	M8	28
40	TS-0571082	Hex Jam Nut	3/4-16UNF	4
41	DDS225-241	Conveyor		1
42	TS-0561031	Hex Nut	3/8-16NC	1
43	DDS225-243	Front Cover		1
44	DDS225-244	Rear Cover		1
45	DDS225-245	Threaded Bushing		4
46	DDS225-246	Handwheel		1
47	TS-0270071	Socket Set Screw	5/16-18 x 3/4	2
48	DDS225-248	Leadscrew Holder, Left-Rear		1
49	TS-0208041	Socket Head Cap Screw	5/16-18 x 3/4	6
50	TS-0561011	Hex Nut	1/4-20	8
51	TS-0680021	Flat Washer	1/4	8
52	DDS225-336	Hex Head Screw	1/4-20x3/8	8
53	DDS237-257	Lower Bracket		4
54	DDS237-259	Upper Bracket		4
55	TS-0680011	Flat Washer	3/16	8

# Conveyor Assembly – DDS-225

Index No.	Part No.	Description	Size	Qty
56	TS-081C022	Screw	#10-24 x 3/8	8
57	DDS237-260	Boot		4
58	DDS237-258	Special Washer		4
59	TS-0208021	Socket Head Cap Screw	5/16-18 x 1/2	8
60	DDS225-260	Nylon Washer		4
61	TS-0267051	Set Screw	1/4-20x1/2	4

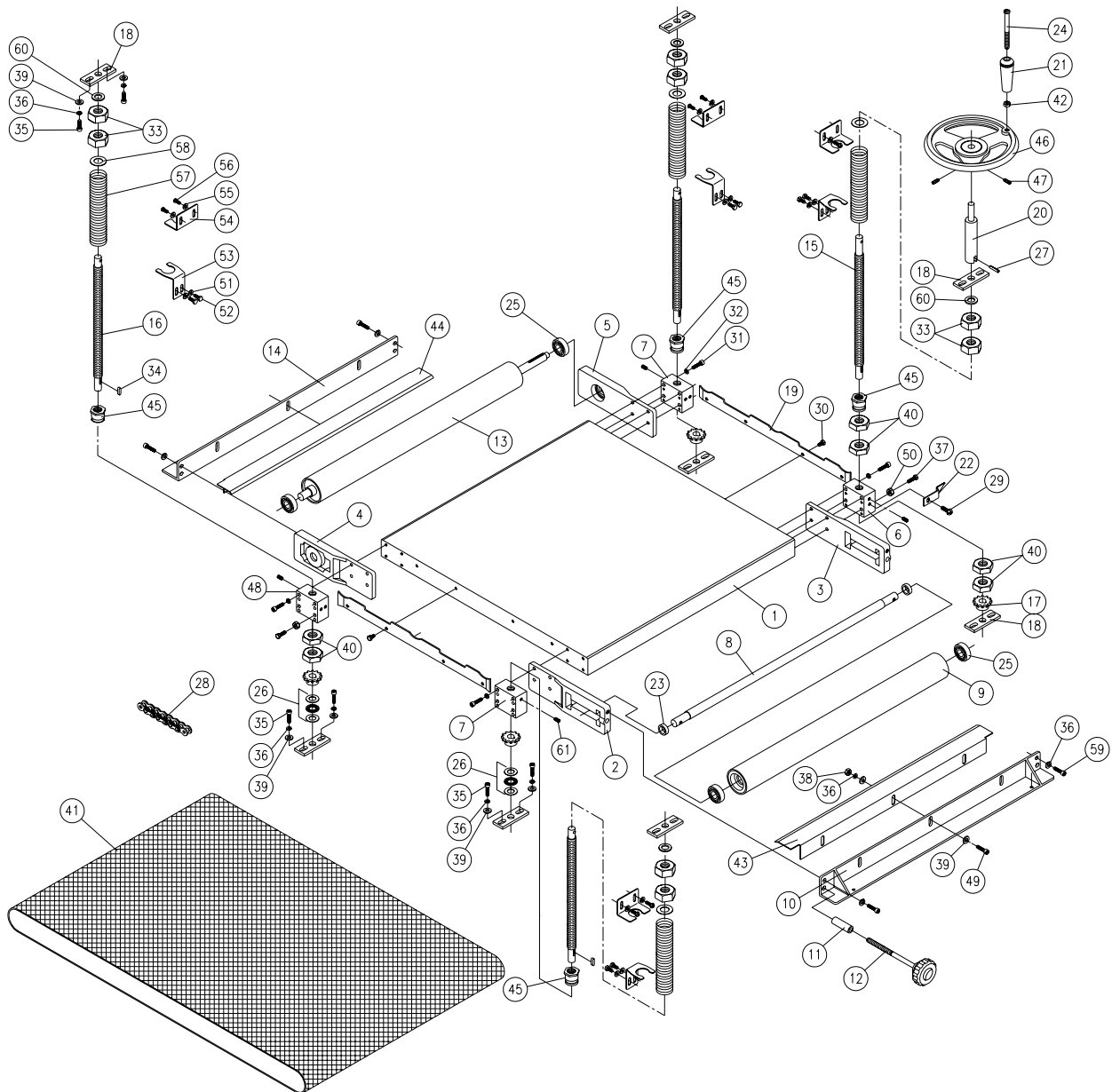

## Motor & Cabinet Assembly – DDS-225

Index No.	Part No.	Description	Size	Qty
1	DDS225-301	Cabinet		1
2	DDS225-302	Support Bracket-Front		1
3	DDS225-303	Support Bracket-Rear		1
4	DDS225-304	Motor Plate		1
5	DDS225-305	Motor Pulley		1
6	DDS225-306	Motor	5HP, 1Ph, 230V	1
7	DDS225-307	Adjusting Screw		2
8	DDS225-308	Hinge		2
9	DDS225-309	Fixed Block		1
10	DDS225-310	Cylinder		1
11	DDS225-311	Flow Deflector		1
12	DDS225-312	Top Cover		1
13	DDS225-313	Dust Chute		2
14	DDS225-314	Roller Holder		1
15	DDS225-315	Idle Roller		1
16	DDS225-316	Switch Bracket		1
17	DDS225-317	Direction Label		1
18	DDS225-318	Scale		1
19	DDS225-319	Spacer		1
20	DDS225-320	Door Latch		3
21	DDS225-321	Handle		1
22	DDS225-322	Magnetic Switch		1
23	DDS225-323	Power Cord		1
24	DDS225-324	Strain Relief		2
25	DDS225-325	Key	5 x 5 x55 mm	1
26	DDS225-326	Screw	3/16-24 x 1/2	18
27	TS-0720051	Lock Washer	#10	22
28	TS-0060031	Hex Cap Screw	3/8-16 x 3/4	6
29	TS-0720091	Lock Washer	3/8	10
30	TS-1550071	Flat Washer	M10	4
31	TS-0050051	Hex Cap Screw	1/4-20 x 1	1
32	TS-0207021	Socket Head Cap Screw	1/4-20 x 1/2	2
33	TS-0720071	Lock Washer	1/4	20
34	TS-0050061	Hex Cap Screw	1/4-20 x 1-1/4	1
35	TS-0640071	Hex Nylon Lock Nut	1/4-20NC	2
36	DDS225-336	Hex Head Screw	1/4-20 X 3/8	6
37	TS-0680021	Flat Washer	1/4	10
38	TS-0050011	Hex Cap Screw	1/4-20 x 1/2	6
39	TS-0208041	Socket Head Cap Screw	5/16-18 x 3/4	2
40	TS-0561021	Hex Nut	5/16-18NC	2
42	DDS225-342	Flat Washer	8mm x 30 x 3T	5
43	TS-0270031	Socket Set Screw	5/16-18 x 3/8	2
44	TS-0561031	Hex Nut	3/8-16NC	10
45	TS-0060061	Hex Cap Screw	3/8-16NC x 1-1/4	4
46	DDS225-346	Shoulder Screw		1
47	TS-0208061	Hex Cap Screw	5/16-18 x 1	1
48	TS-081F032	Phillips Pan Head Machine Screw	1/4-20 x 1/2	4
50	DDS225-350	Label (Drum Setting Gauge)		2
51	TS-1550061	Flat Washer	M8	1
52	TS-1550071	Flat Washer	M10	8
53	DDS225-353	Strain Relief		2
54	DDS225-354	Motor Cord		1
55	DDS225-355	Front Cover		1
56	TS-1550031	Flat Washer	M5	14
58	DDS225-358	Screw	3/16-24 x 3/8	8



## Motor & Cabinet Assembly – DDS-225

Index No.	Part No.	Description	Size	Qty
59	DDS225-359	Rear Cover		1
60	DDS225-360	Self Tapping Screw	#10 x 1/2	2
61	TS-069204	Flat Washer	SAE #10	2
62	DDS225-362	Lock Piece		2
63	DDS225-363	Plastic Nut		2
64	DDS225-364	Lock Housing		2
65	DDS225-365	Lock Knob		2
66	TS-0207011	Socket Head Cap Screw	1/4-20 x 3/8	4
68	DDS225-368	Holder		2
69	DDS225-369	Plate		1
70	TS-1490111	Hex Cap Screw	M8 x 60	2
72	DDS225-372	Spring		2
73	TS-1540061	Hex Nut	M8	2
74	TS-081F022	Phillips Pan Head Machine Screw	1/4-20 x 3/8	4
75	DDS225-375	Screw	3/16-24 x 1-1/4	2
76	DDS225-376	Limit Switch		1
77	DDS225-377	Cord Holder		2
78	DDS225-378	Switch Cord, Mag. Switch to Main Motor		1
79	DDS225-379	Switch Cord, Reverse Switch to Conveyor Motor		1
80	TS-2284082	Phillips Pan Head Machine Screw	M4 x 8	1
81	DDS225-381	Switch Cover		1
82	DDS225-382	Reverse Switch		1
83	DDS225-383	Switch Bracket		1
84	DDS225-384	Strain Relief		2
85	3312341	Powermatic Logo		1
86	DDS225-WL	Warning Label (not shown)		1

# Motor & Cabinet Assembly – DDS-225

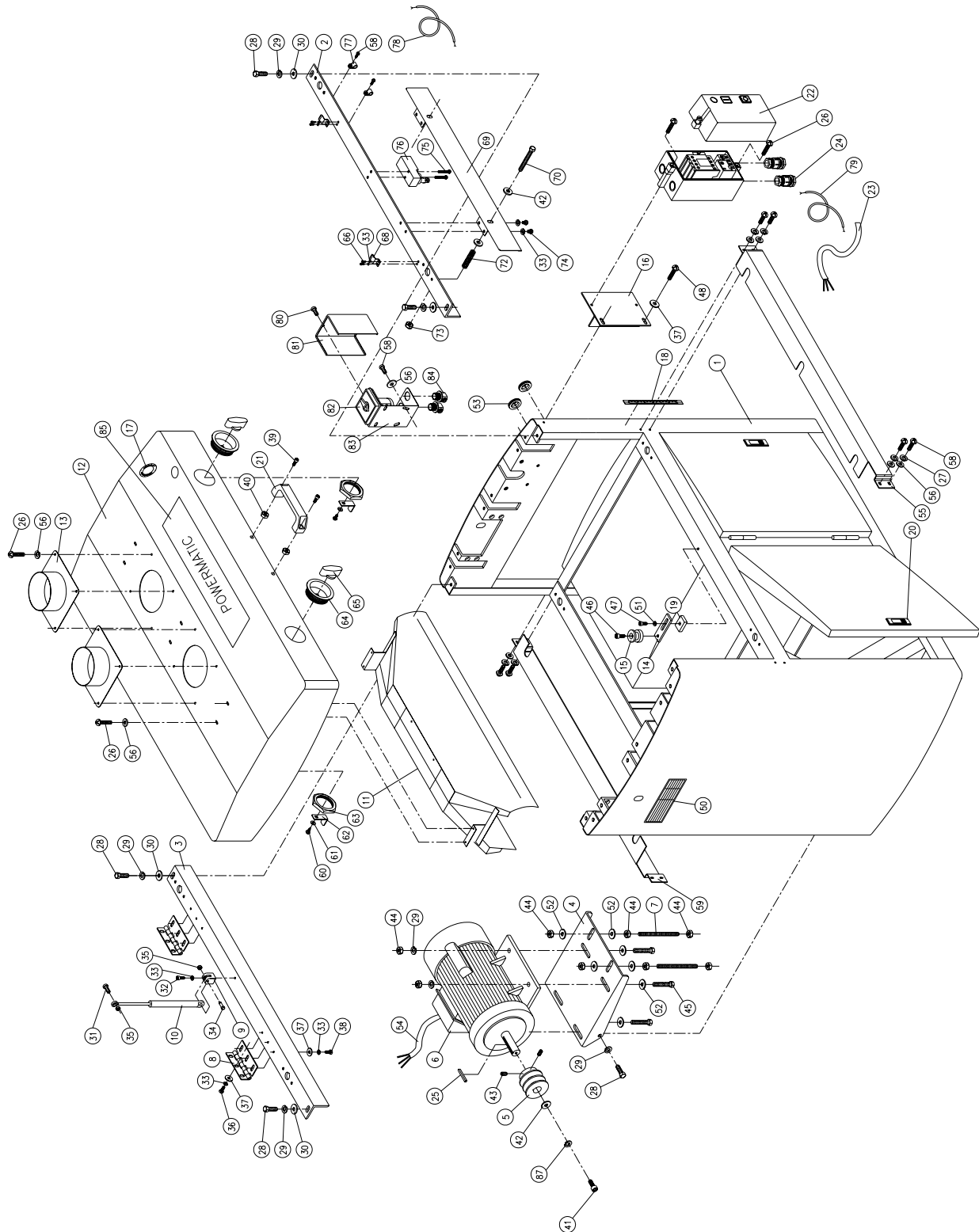

## Gearbox Assembly – DDS-225 Drum

Index No.	Part No.	Description	Size	Qty
1	DDS225-401	Gearbox Body		1
2	TS-0720071	Lock Washer	1/4	4
3	TS-0207071	Socket Head Cap Screw	1/4-20 x 1-1/4	4
4	DDS225-404	Drain Plug		1
5	BB-626VV	Ball Bearing		2
6	DDS225-406	Gear	66T	1
7	DDS225-407	Key	4 x 4 x 8	1
8	DDS225-408	Pinion		1
9	BB-6000VV	Ball Bearing	6000VV	1
10	DDS225-410	C-Ring		1
11	DDS225-411	Gear	70T	1
12	DDS225-412	Gear	57T	1
13	DDS225-413	Shaft		1
14	BB-6002VV	Ball Bearing	6002VV	2
15	DDS225-415	Key	5 x 5 x 20	1
16	DDS225-416	Shaft		1
17	DDS225-417	Cover		1
18	TS-1503041	Socket Head Cap Screw	M6 x 16	9
19	DDS225-419	Key	5 x 5 x 30	1
20	DDS225-420	Collar		1
21	DDS225-421	Oil Plug		1
22	DDS225-422	Handle		1
23	BB-6006VV	Ball Bearing		1
24	DDS225-424	C-Ring		1
25	DDS225-425	Gear	64T	1
26	DDS225-426	Key	8 x 8 x 15	1
27	DDS225-427	Block		1
28	DDS225-428	Pin		1
29	DDS225-429	Gear	77T	1
30	DDS225-430	Key	6 x 6 x 50	1
31	DDS225-431	Cable		1
32	DDS225-432	Motor	1/4HP, 1Ph, 230V	1
	DDS225-432MF	Motor Fan		1
	DDS225-432MFC	Motor Fan Cover		1
	DDS225-432RC	Running Capacitor	10µF, 350VAC	1
	DDS225-432JB	Junction Box		1
	DDS225-432JBC	Junction Box Cover		1
33	DDS225-433	Gasket		2
34	DDS225-434	Steel Ball		1
35	DDS225-435	Spring		1
36	TS-1523011	Socket Set Screw	M6 x 6	1

# Gearbox Assembly – DDS-225 Drum

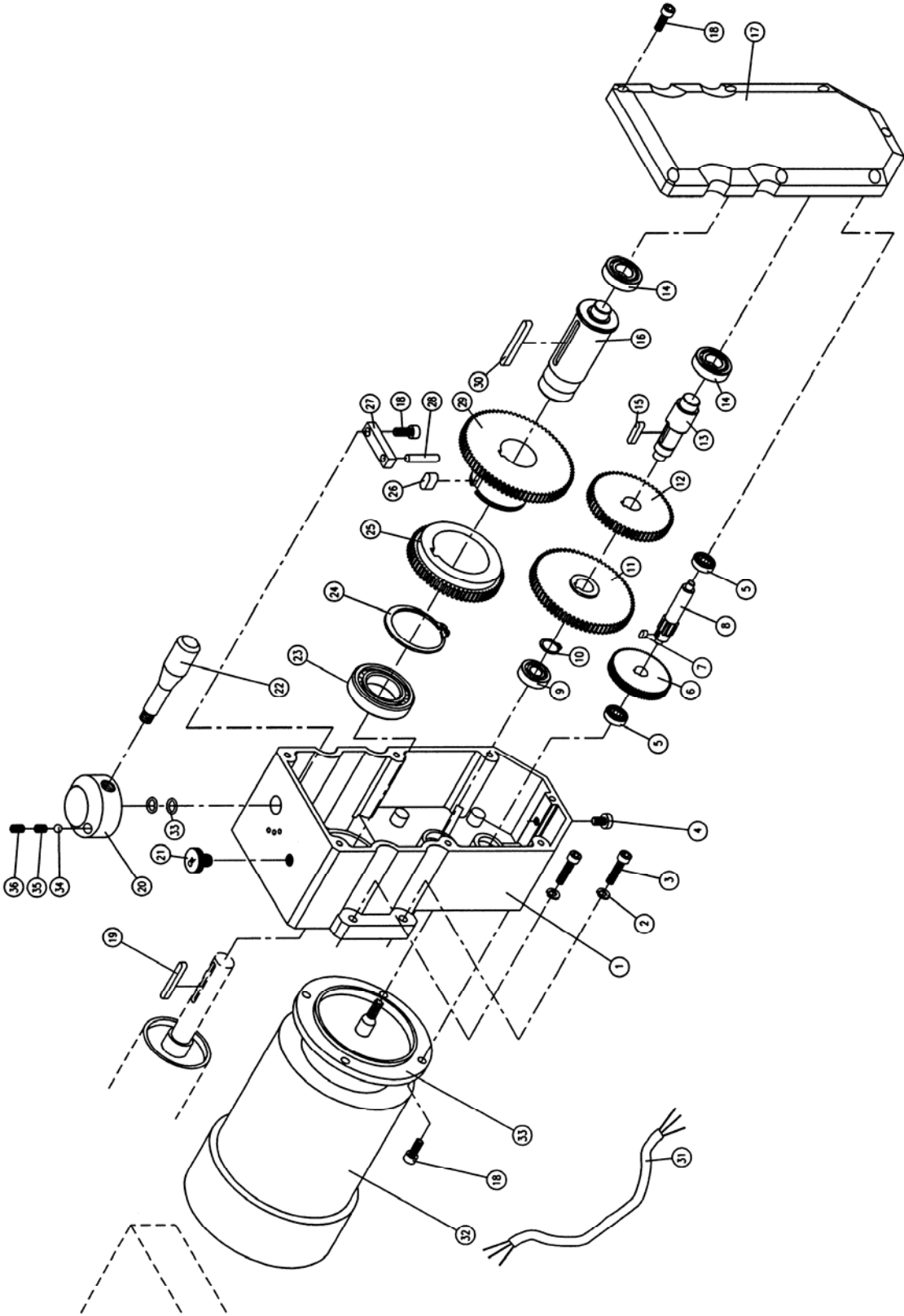

# Parts – DDS-237 Sander

## Drum Assembly – DDS-237

Index No.	Part No.	Description	Size	Qty
1	DDS237-101	Rear Drum		1
2	DDS225-102	Abrasive Fastener-Right		2
3	DDS225-103	Abrasive Fastener-Left		2
4	DDS225-104	Spring		2
5	DDS225-105	Locking Wedge		4
6		Abrasive (80 Grit) – see <i>Optional Accessories</i> on page 38		1
7		Abrasive (100 Grit) – see <i>Optional Accessories</i> on page 38		1
8	DDS225-108	Pulley		2
9	DDS237-109	Tension Roller		3
10	DDS225-110	Bushing		6
11	DDS225-111	Spring		6
12	DDS225-112	Bracket		6
13	DDS225-113	Bearing Assembly	UCFL205	4
14	VB-B70	Belt	B-70	2
15	DDS225-115	Key	8 x 7 x 50	2
16	DDS225-116	Adjusting Bushing		6
17	TS-0561031	Hex Nut	3/8-16	2
18	TS-0208031	Socket Head Cap Screw	5/16-18 x 5/8	12
19	TS-0720081	Lock Washer	5/16	12
20	TS-0060061	Hex Cap Screw	3/8-16 x 1-1/4	8
21	TS-0070031	Hex Cap Screw	1/2-13 x 1-1/2	4
22	TS-0720111	Lock Washer	1/2	8
23	TS-0060081	Hex Cap Screw	3/8-16 x 1-3/4	4
24	TS-0720091	Lock Washer	3/8	8
25	TS-1550071	Flat Washer	M10	4
26	TS-0207061	Socket Head Cap Screw	1/4-20 x 1	4
27	TS-0270051	Socket Set Screw	5/16-18 x 1/2	4
29	TS-0060051	Hex Cap Screw	3/8-16 x 1	2
30	TS-0208021	Socket Head Cap Screw	5/16-18 x 1/2	4
31	TS-0270051	Socket Set Screw	5/16-18 x 1/2	2
32	DDS225-132	Spring		2
33	DDS225-133	Steel Ball	Ø1/4	2
34	TS-0267021	Socket Set Screw	1/4-20 x 1/4	4
35	DDS225-135	Adjusting Knob		2
36	DDS225-136	Lead Screw		2
37	TS-0207041	Socket Head Cap Screw	1/4-20 x 3/4	4
38	TS-0680061	Flat Washer	1/2	4
39	TS-0720071	Lock Washer	1/4	4
40	DDS225-140	Top Cover-Right		1
41	DDS225-141	Collar		2
42	DDS225-142	Slide		2
43	DDS225-143	Locking Lever		2
44	DDS225-144	Slide Bracket-Right		1
45	TS-0561011	Hex Nut	1/4-20	4
46	TS-0267091	Socket Set Screw	1/4-20 x 1	4
47	DDS225-147	Gib-Right		1
48	DDS225-148	Top Cover-Left		1
49	TS-1541041	Nylon Insert Lock Nut	M10	6
50	DDS225-150	Adjusting Screw		6
51	DDS225-151	Hex Nut	M22 x 1.5P x 5T	6
52	DDS225-152	Slide Bracket-Left		1
53	DDS225-153	Gib-Left		1
54	DDS237-154	Front Drum		1

# Drum Assembly – DDS-237

Index No.	Part No.	Description	Size	Qty
55	TS-1521041	Socket Set Screw	M4 x 10	4
56	DDS225-156	Roll Pin	Ø2 x 8mm	2
57	TS-0720091	Lock Washer	3/8	8
58	TS-0100041	Hex Cap Screw	1/2-13x 1-1/4	4

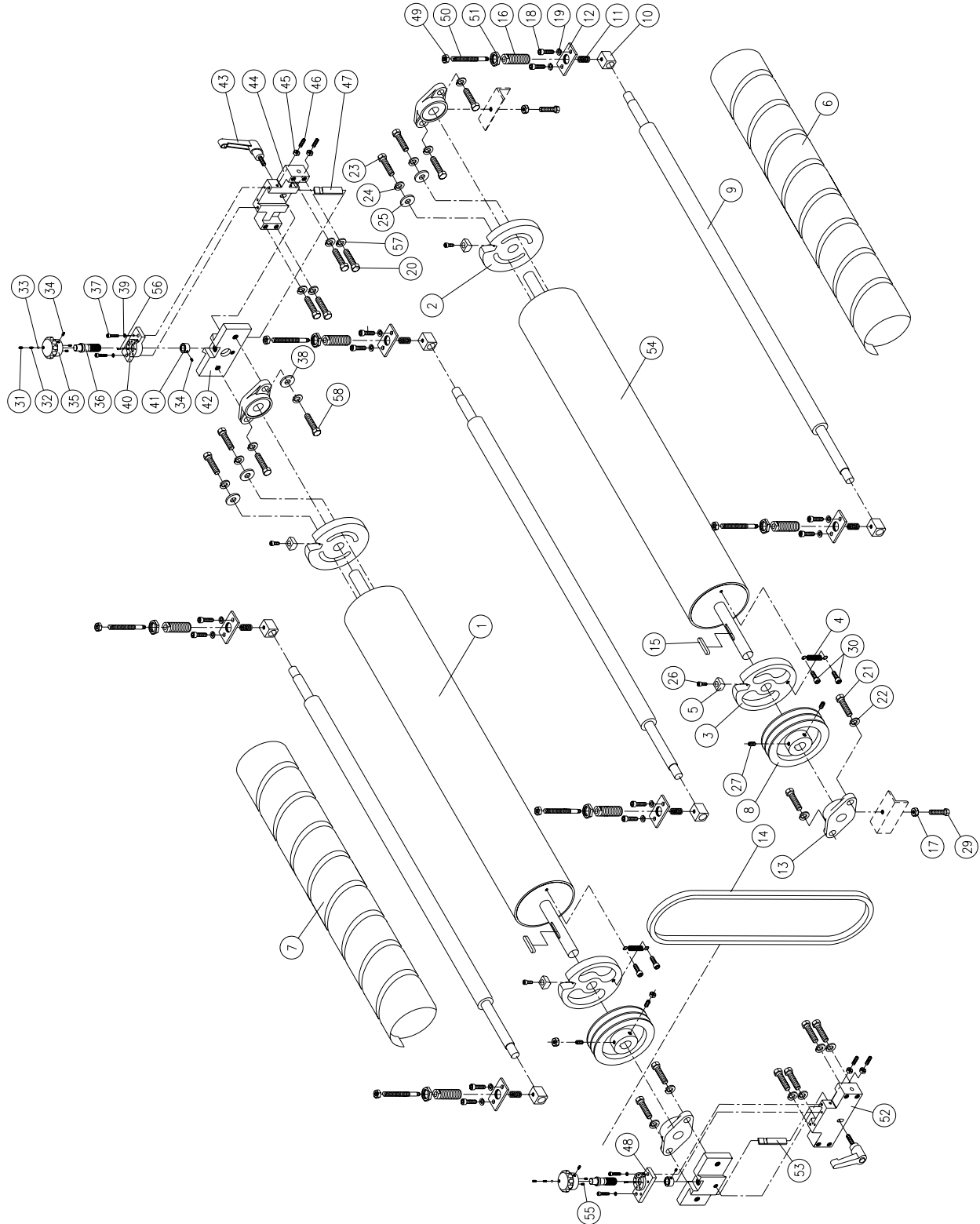

## Conveyor Assembly – DDS-237

Index No.	Part No.	Description	Size	Qty
1	DDS237-201	Table		1
2	DDS225-202	Support Bracket, Left-Front		1
3	DDS225-203	Support Bracket, Right-Front		1
4	DDS225-204	Support Bracket, Left-Rear		1
5	DDS225-205	Support Bracket, Right-Rear		1
6	DDS225-206	Leadscrew Holder, Right-Front		1
7	DDS225-207	Leadscrew Holder, Left-Front and Right-Rear		2
8	DDS237-208	Rod		1
9	DDS237-209	Front Roller		1
10	DDS237-210	Front Support Plate		1
11	DDS225-211	Collar		2
12	DDS225-212	Adjusting Knob		2
13	DDS237-213	Rear Roller		1
14	DDS237-214	Rear Support Plate		1
15	DDS225-215	Drive Leadscrew		1
16	DDS225-216	Driven Leadscrew		3
17	DDS225-217	Sprocket		4
18	DDS225-218	Support Bracket		8
19	DDS225-219	Guide Plate		2
20	DDS225-220	Post		1
21	DDS225-221	Handle		1
22	DDS225-222	Pointer		1
23	DDS225-223	Collar		2
24	DDS225-224	Bolt		1
25	BB-6203ZZ	Ball Bearing	6203ZZ	4
26	DDS225-226	Thrust Bearing		4
27	DDS225-227	Roll Pin	Ø6 x 25mm	1
28	DDS237-228	Chain		1
29	TS-0813022	Round Head Machine Screw	1/4-20 x 3/8	1
30	TS-0050011	Hex Cap Screw	1/4-20 x 1/2	8
31	TS-0207111	Socket Head Cap Screw	1/4-20 x 2-1/4	16
32	TS-0720071	Lock Washer	1/4	16
33	TS-0561082	Hex Nut	3/4-16UNF	8
34	DDS225-234	Key	5 x 5 x 18mm	4
35	TS-0208041	Socket Head Cap Screw	5/16-18 x 3/4	16
36	TS-0720081	Lock Washer	5/16	24
39	TS-1550061	Flat Washer	M8	16
40	TS-0571082	Hex Jam Nut	3/4-16UNF	4
41	DDS237-241	Conveyor		1
42	TS-0561031	Hex Nut	3/8-16	1
43	DDS237-243	Front Cover		1
44	DDS237-244	Rear Cover		1
45	DDS225-245	Threaded Bushing		4
46	DDS225-246	Hand Wheel		1
47	TS-0270051	Socket Set Screw	5/16-18 x 1/2	2
48	DDS225-248	Leadscrew Holder, Left-Rear		1
49	TS-0208041	Socket Head Cap Screw	5/16-18 x 3/4	6
50	TS-0680031	Flat Washer	5/16	12
51	TS-0720081	Lock Washer	5/16	6
52	TS-0561021	Hex Nut	5/16-18	6
53	TS-0208021	Socket Head Cap Screw	5/16-18 x 1/2	8
54	TS-0561011	Hex Nut	1/4-20	8
55	TS-0050081	Hex Cap Screw	1/4-20 x 1-3/4	8
56	TS-0680011	Flat Washer	3/16	8
57	DDS237-257	Lower Bracket		4

# Conveyor Assembly – DDS-237

Index No.	Part No.	Description	Size	Qty
58	DDS237-258	Special Washer		4
59	DDS237-259	Upper Bracket		4
60	DDS237-260	Boot		4
61	TS-081C022	Screw	#10-24 x 3/8	8
62	TS-0680021	Flat Washer	1/4	8
63	DDS225-336	Hex Head Screw	1/4-20 x 3/8	8
64	DDS225-260	Nylon Washer		4
65	TS-0267051	Set Screw	1/4-20x1/2	4

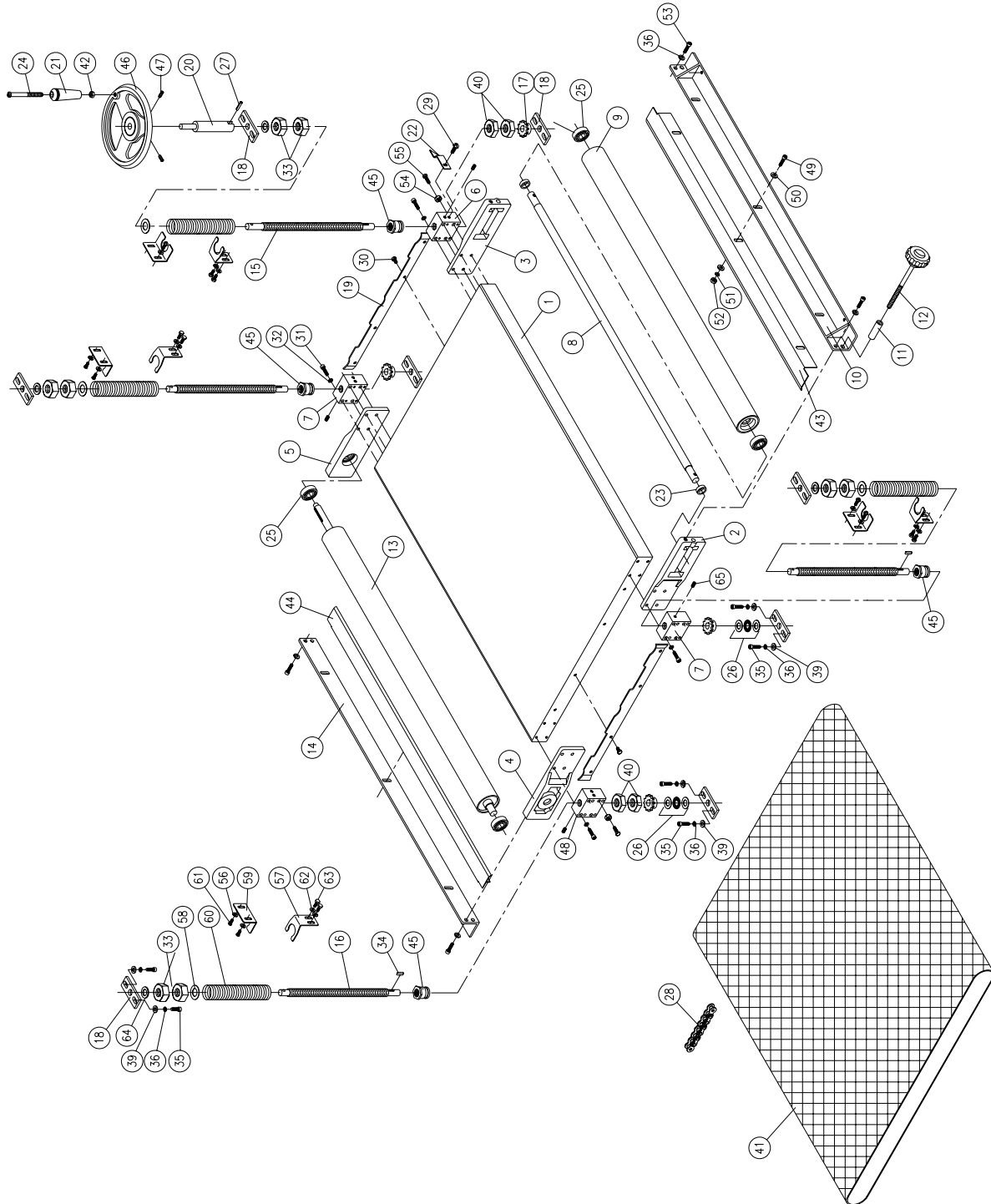



## Motor and Cabinet Assembly – DDS-237

Index No.	Part No.	Description	Size	Qty
1	DDS237-301	Cabinet		1
2	DDS237-302	Support Bracket-Front		1
3	DDS237-303	Support Bracket-Rear		1
4	DDS237-304	Motor Plate		1
5	DDS237-305	Motor Pulley		1
6	DDS237-306	Motor	7-1/2HP, 1Ph, 230V	1
	DDS237-306MF	Motor Fan		1
	DDS237-306MFC	Motor Fan Cover		1
	DDS237-306CS	Centrifugal Switch		1
	DDS237-306SC	Starting Capacitor	250MFD, 250VAC	2
	DDS237-306RC	Running Capacitor	50µF, 450VAC	1
	DDS237-306SCC	Starting Capacitor Cover		1
	DDS237-306RCC	Running Capacitor Cover		1
	DDS237-306JB	Junction Box		1
	DDS237-306JBC	Junction Box Cover		1
6	DDS237-306A	Motor	10HP, 3Ph, 230/460V	1
	DDS237-306AMF	Motor Fan		1
	DDS237-306MFC	Motor Fan Cover		1
	DDS237-306JB	Junction Box		1
	DDS237-306JBC	Junction Box Cover		1
7	DDS225-307	Adjusting Screw		2
8	DDS225-308	Hinge		3
9	DDS225-309	Fixed Block		2
10	DDS225-310	Cylinder		2
11	DDS237-311	Flow Deflector		1
12	DDS237-312	Top Cover		1
13	DDS225-313	Dust Chute		2
14	DDS225-314	Roller Holder		1
15	DDS225-315	Idle Roller		1
16	DDS237-316	Switch Bracket		1
17	DDS225-317	Direction Label		1
18	DDS225-318	Scale		1
19	DDS225-319	Spacer		1
20	DDS225-320	Door Latch		3
21	DDS225-321	Handle		1
22	DDS237-322	Magnetic Switch (for 7-1/2HP, 1Ph, 230V)		1
	DDS237-322C	Contact		1
	DDS237-322R	Relay		1
22	DDS237-322A	Magnetic Switch (for 10HP, 3Ph, 230V)		1
	DDS237-322AC	Contact		1
	DDS237-322AR	Relay		1
22	DDS237-322B	Magnetic Switch (for 10HP, 3Ph, 460V)		1
	DDS237-322BC	Contact		1
	DDS237-322BR	Relay		1
23	DDS237-323	Power Cord	1Ph	1
	DDS237-323A	Power Cord	3Ph	1
24	DDS237-324	Strain Relief		2
25	DDS237-325	Key	10 x 8 x 55 mm	1
26	TS-081C032	Screw	#10-24 x 1/2	18
27	TS-0720051	Lock Washer	#10	2
28	TS-0209031	Socket Head Cap Screw	3/8-16 x 3/4	6
29	TS-0720091	Lock Washer	3/8	10
30	TS-1550071	Flat Washer	M10	4
31	TS-1504051	Socket Head Cap Screw	M8 x25	2
32	TS-0207021	Socket Head Cap Screw	1/4-20 x 1/2	1

## Motor and Cabinet Assembly – DDS-237

Index No.	Part No.	Description	Size	Qty
33	TS-0720071	Lock Washer	1/4	26
34	DDS237-334	Shoulder Screw	M8 X1.25P X11	2
35	TS-1541031	Nylon Insert Lock Nut	M8	4
36	TS-0050011	Hex Cap Screw	1/4-20 X 1/2	9
37	TS-0680021	Flat Washer	1/4	18
38	TS-0050011	Hex Cap Screw	1/4-20 x 1/2	9
39	TS-0208041	Socket Head Cap Screw	5/16-18 x 3/4	2
40	TS-0561021	Hex Nut	5/16-18	2
41	TS-1505021	Socket Head Cap Screw	M10 x 20	1
42	TS-1550071	Flat Washer	M10	1
43	TS-0270051	Socket Set Screw	5/16-18 x 1/2	2
44	TS-0561031	Hex Nut	3/8-16	10
45	TS-0060071	Hex Cap Screw	3/8-16 x 1-1/2	4
46	DDS225-346	Shoulder Screw		1
47	TS-0208061	Socket Head Cap Screw	5/16-18 x 1	1
48	TS-081F032	Phillips Pan Head Machine Screw	1/4-20 x 1/2	4
50	DDS225-350	Label (Drum Setting Gauge)		2
51	TS-0680031	Flat Washer	5/16	1
52	TS-0680041	Flat Washer	3/8	8
53	DDS225-353	Strain Relief		2
54	DDS237-354	Motor Cord	1Ph	1
	DDS237-354A	Motor Cord	3Ph	1
55	DDS237-355	Front Cover		1
56	TS-0680011	Flat Washer	3/16	26
57	DDS225-WL	Warning Label		1
58	TS-081C022	Screw	#10-24 x 3/8	14
59	DDS237-359	Rear Cover		1
60	DDS225-360	Self Tapping Screw	#10 x 1/2	2
61	TS-069204	Flat Washer	SAE #10	2
62	DDS225-362	Lock Piece		2
63	DDS225-363	Plastic Nut		2
64	DDS225-364	Lock Housing		2
65	DDS225-365	Lock Knob		2
66	TS-0207021	Socket Head Cap Screw	1/4-20 x 1/2	4
67	TS-0720071	Lock Washer	1/4	4
68	DDS225-368	Holder		2
69	DDS237-369	Plate		1
70	TS-1490111	Hex Cap Screw	M8 x 60	2
71	TS-1550061	Flat Washer	M8	2
72	DDS225-372	Spring		2
73	TS-1540061	Hex Nut	M8	2
74	TS-0813022	Round Head Machine Screw	1/4-20 x 3/8	4
75	DDS225-375	Screw	#10-24 x 1-1/4	2
76	DDS225-376	Limit Switch		1
77	DDS225-377	Cord Holder		2
78	DDS225-378	Cord, Limit Switch		1
79	DDS237-379	Switch Cord, Mag Switch to Reverse Switch (for 7-1/2HP, 1Ph, 230V)		1
	DDS237-379A	Switch Cord, Mag Switch to Reverse Switch (for 10HP, 3Ph, 230/460V)		1
80	TS-2284082	Screw	M4 x 8	1
81	DDS225-381	Switch Cover		1
82	DDS225-382	Reverse Switch (for 7-1/2HP, 1Ph, 230V)		1
	DDS237-382	Reverse Switch (for 10HP, 3Ph, 230/460V)		1
83	DDS225-383	Switch Bracket		1
84	DDS225-384	Strain Relief		2
85	DDS237-385	Powermatic Logo		1

# Motor and Cabinet Assembly – DDS-237

Index No.	Part No.	Description	Size	Qty
86	DDS237-386	I.D. Label (not shown)		1
87	TS-2361101	Lock Washer	M10	1
88	DDS237-388	Pad		4
89	DDS237-389	Strain Relief		2

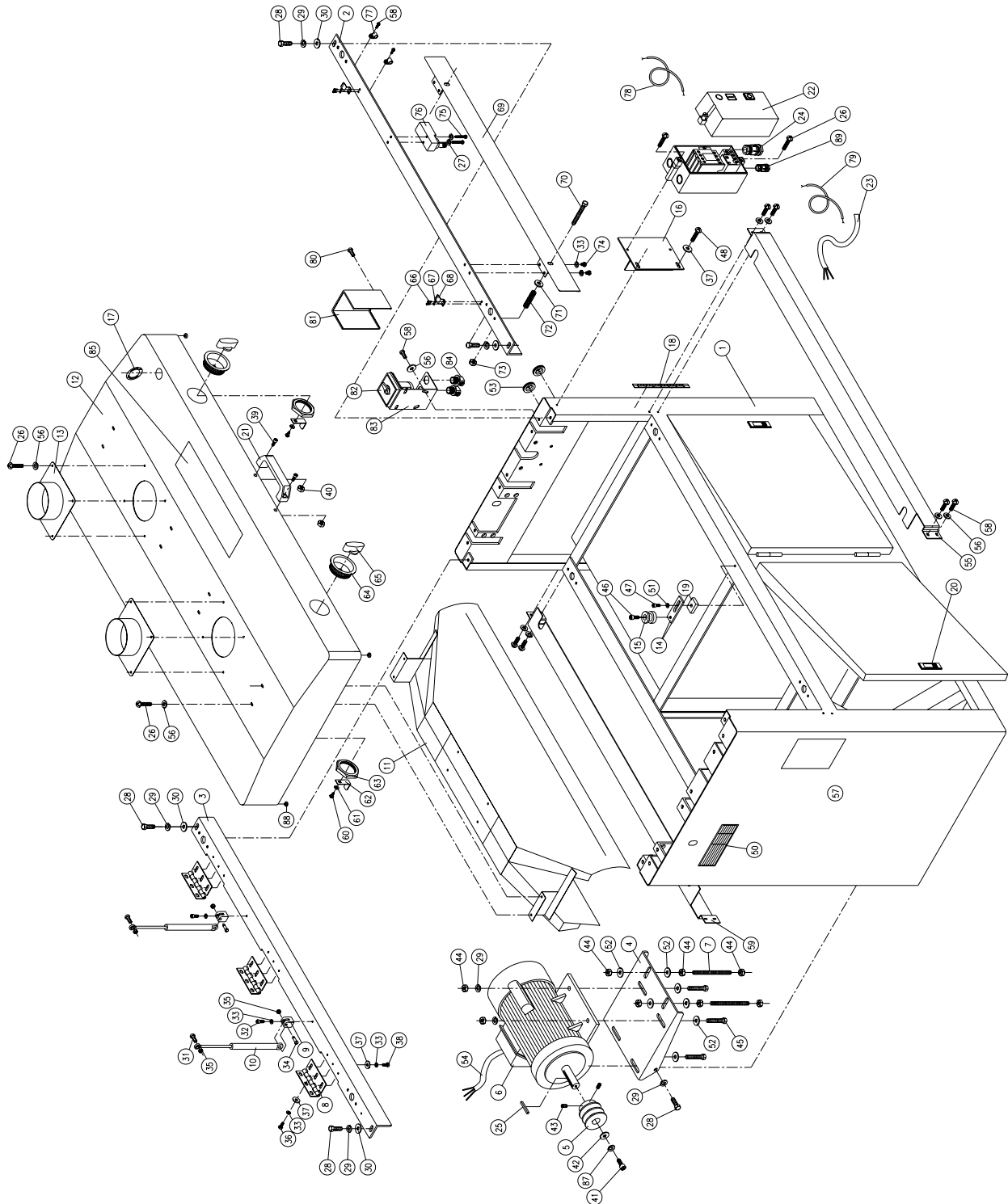

## Gearbox Assembly – DDS-237

Index No.	Part No.	Description	Size	Qty
1	DDS225-401	Gearbox Body		1
2	TS-0720071	Lock Washer	1/4	4
3	TS-0207071	Socket Head Cap Screw	1/4-20 x 1-1/4	4
4	DDS225-404	Drain Plug		1
5	BB-626VV	Ball Bearing		2
6	DDS225-406	Gear	66T	1
7	DDS225-407	Key	4 x 4 x 8	1
8	DDS225-408	Pinion		1
9	BB-6000VV	Ball Bearing	6000VV	1
10	DDS225-410	C-Ring		1
11	DDS225-411	Gear	70T	1
12	DDS225-412	Gear	57T	1
13	DDS225-413	Shaft		1
14	BB-6002VV	Ball Bearing	6002VV	2
15	DDS225-415	Key	5 x 5 x 20	1
16	DDS225-416	Shaft		1
17	DDS225-417	Cover		1
18	TS-1503041	Socket Head Cap Screw	M6 x 16	9
19	DDS225-419	Key	5 x 5 x 30	1
20	DDS225-420	Collar		1
21	DDS225-421	Oil Plug		1
22	DDS225-422	Handle		1
23	BB-6006VV	Ball Bearing		1
24	DDS225-424	C-Ring		1
25	DDS225-425	Gear	64T	1
26	DDS225-426	Key	8 x 8 x 15	1
27	DDS225-427	Block		1
29	DDS225-429	Gear	77T	1
30	DDS225-430	Key	6 x 6 x 50	1
31	DDS225-431	Cable (for 1/4HP, 1Ph, 230V )		1
	DDS237-431	Cable (for 1/4HP, 3Ph, 230/460V)		1
32	DDS225-432	Motor	1/4HP, 1Ph, 230V	1
	DDS225-432MF	Motor Fan		1
	DDS225-432MFC	Motor Fan Cover		1
	DDS225-432RC	Running Capacitor	10µF, 350VAC	1
	DDS225-432JB	Junction Box		1
	DDS225-432JBC	Junction Box Cover		1
32	DDS237-432	Motor	1/4HP, 3Ph, 230/460V	1
	DDS225-432MF	Motor Fan		1
	DDS225-432MFC	Motor Fan Cover		1
	DDS225-432JB	Junction Box		1
	DDS225-432JBC	Junction Box Cover		1
33	DDS225-433	Gasket		2
34	DDS225-434	Steel Ball		1
35	DDS225-435	Spring		1
36	TS-1523011	Socket Set Screw	M6 x 6	1

# Gearbox Assembly – DDS-237

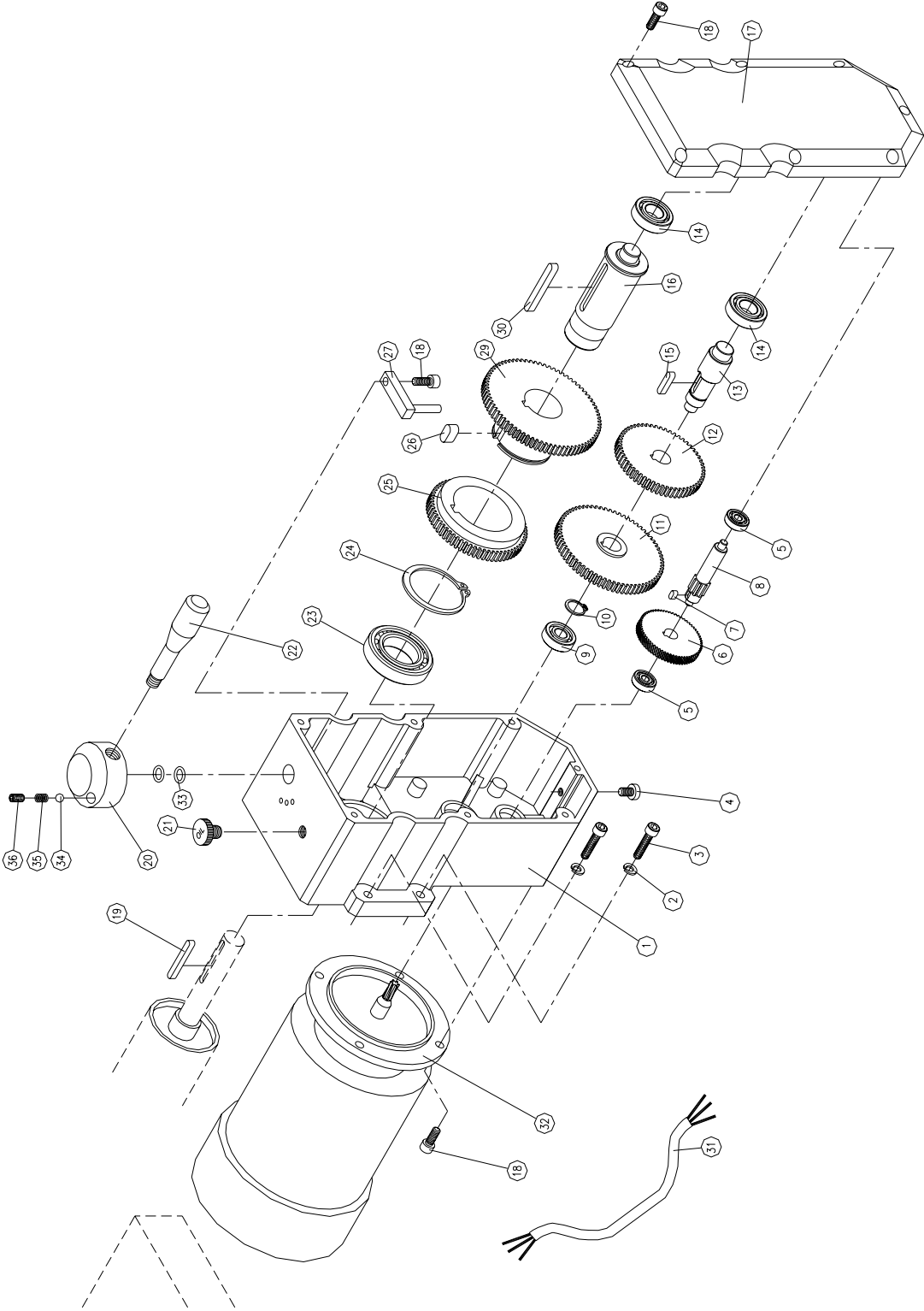

## Optional Accessories

The optional accessories listed below are intended for use with DDS-225 and DDS-237 Drum Sanders.

### Ready-To-Cut Abrasive Strips

<b>Part No.</b>	<b>Description</b>	<b>Normal Use</b>
60-9036	.....36 Grit Sandpaper.....	surfacing rough-sawn boards, stock and glue removal
60-9060	.....60 Grit Sandpaper.....	surfacing and dimensioning boards, truing warped boards
60-9080	.....80 Grit Sandpaper.....	surfacing, light dimensioning, removing planer ripples
60-9100	.....100 Grit Sandpaper.....	light surfacing, removing planer ripples
60-9120	.....120 Grit Sandpaper.....	light surfacing, minimal stock removal
60-9150	.....150 Grit Sandpaper.....	finish sanding, minimal stock removal
60-9180	.....180 Grit Sandpaper.....	finish sanding only, not for stock removal
60-9220	.....220 Grit Sandpaper.....	finish sanding only, not for stock removal

### Other Accessories

57620025 ....JS-1 JET-Stick Belt Cleaner

# Wiring Diagram

## DDS-225 Sander

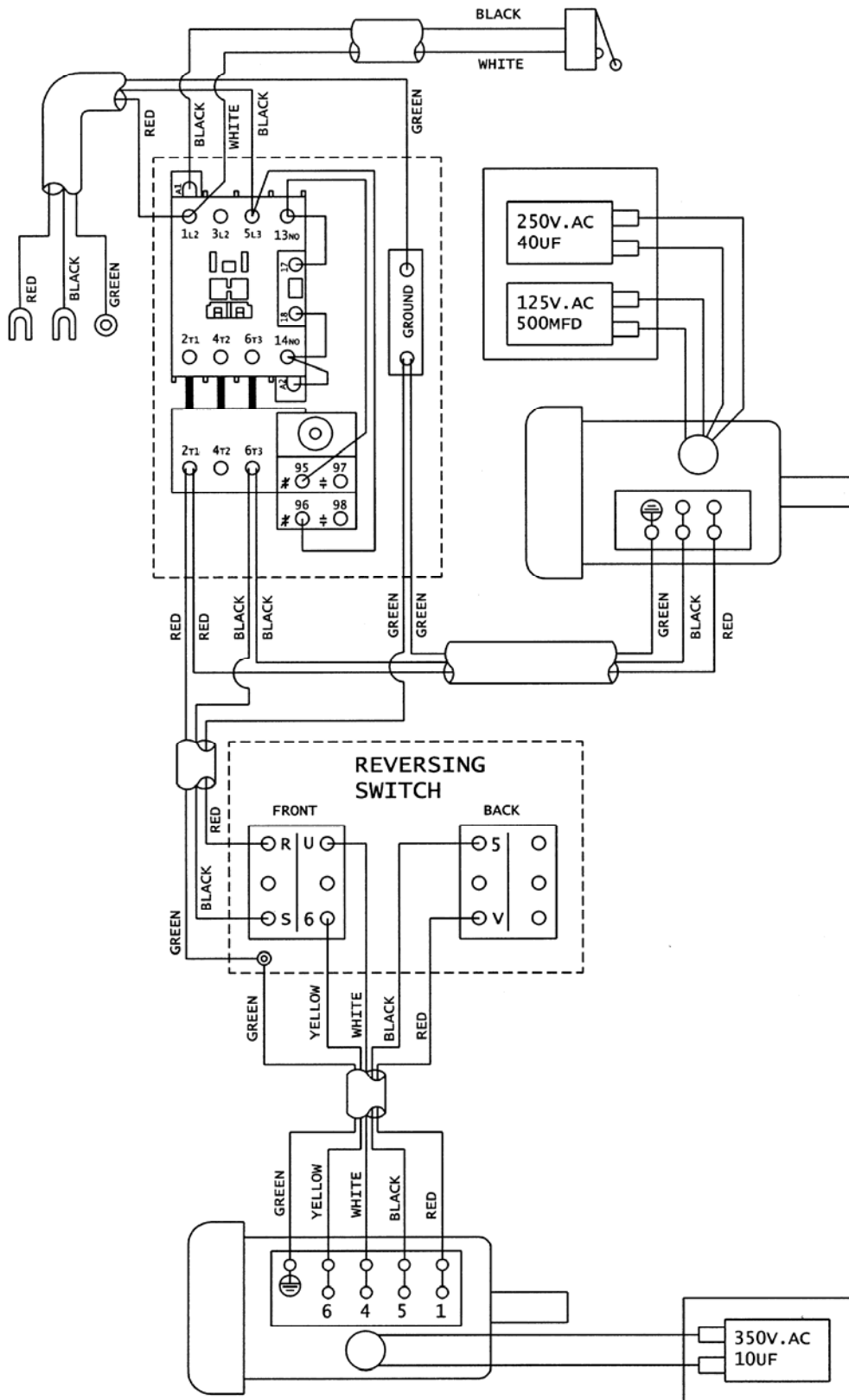

# DDS-237 Sander – 7.5HP, 1Ph, 230V

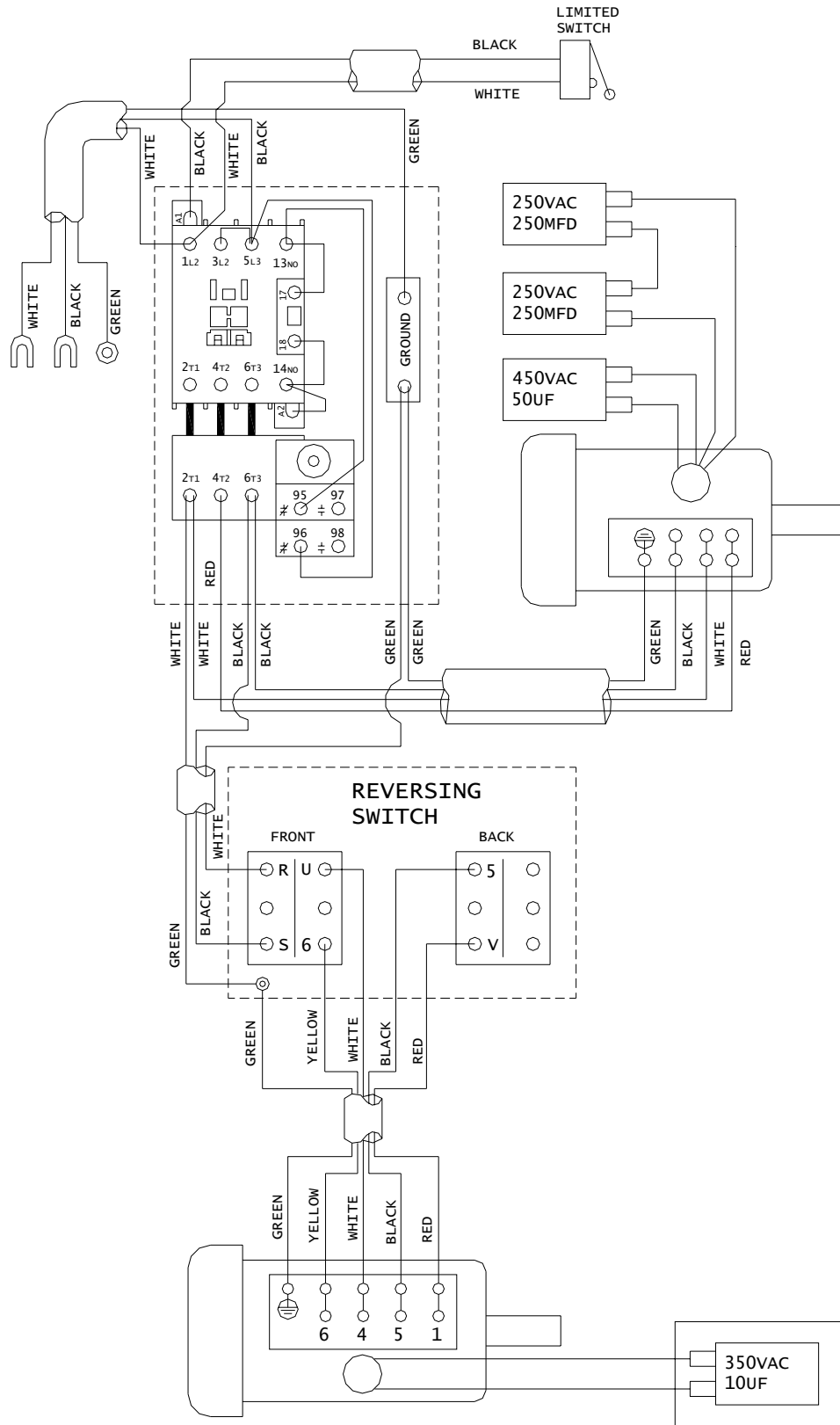



# DDS-237 Sander – 10HP, 3Ph, 230V

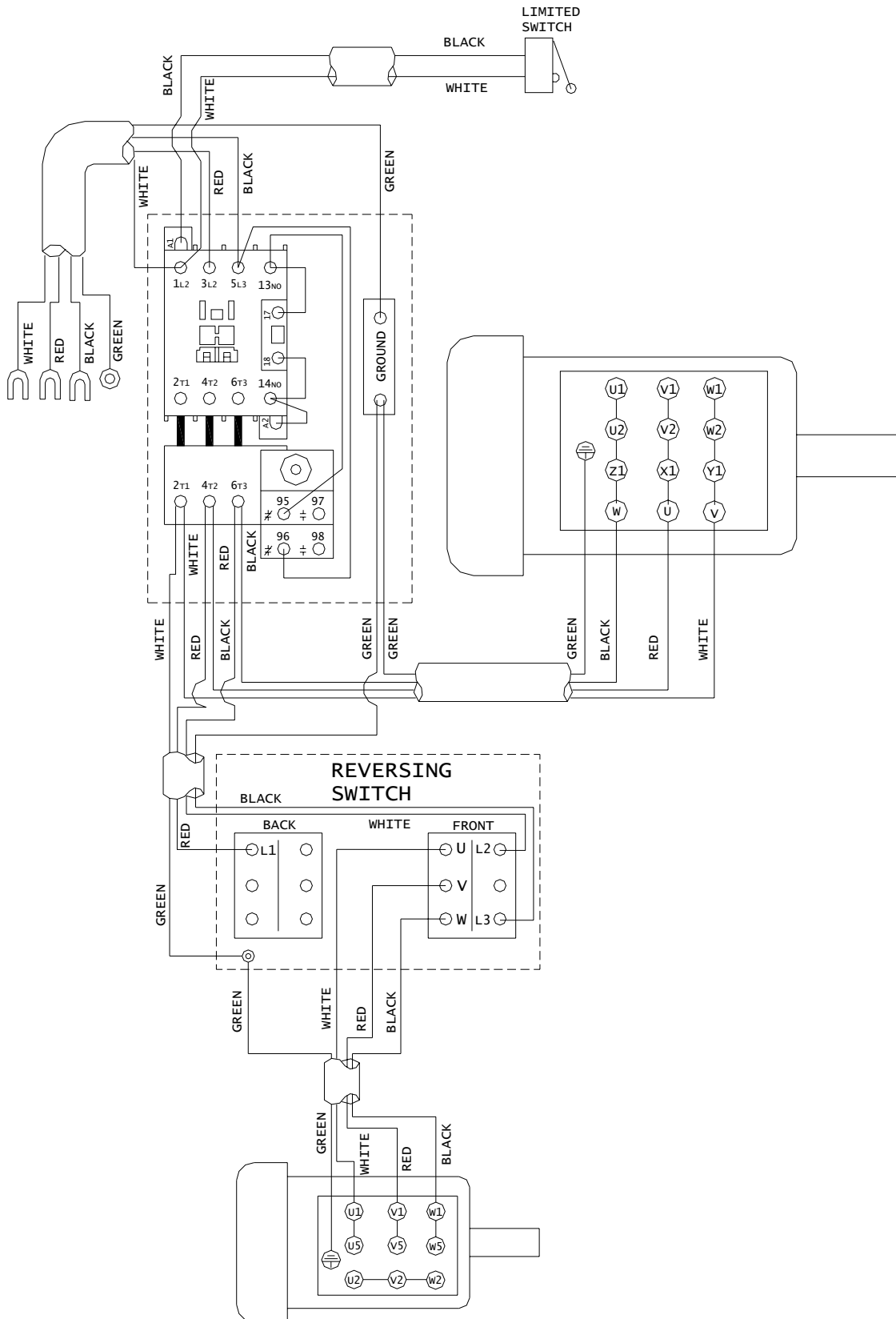

# DDS-237 Sander – 10HP, 3Ph, 460V

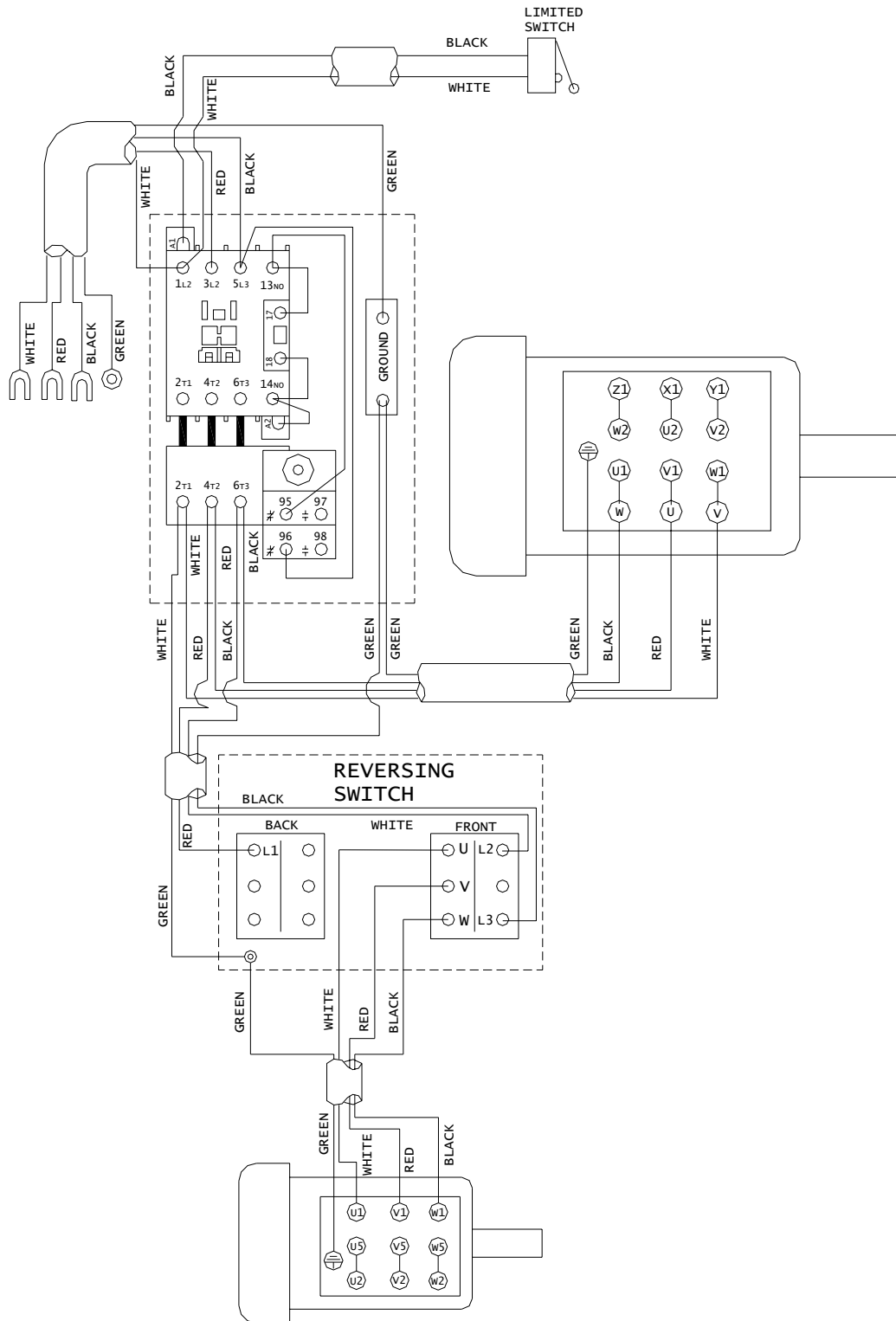

## Notes

***POWERMATIC***<sup>®</sup>

**WMH Tool Group**  
2420 Vantage Drive  
Elgin, Illinois 60124  
Phone: 800-274-6848  
[www.wmhtoolgroup.com](http://www.wmhtoolgroup.com)