

SMOOTHING THE WAY TO PERFECTION.

Metabo manufacture a wide range of quality sanders for those who require a professional finish. The wide range allows the user to select exactly the right sander for the job, be it for sanding flat surfaces, curved surfaces, sanding into corners or along edges. Backed up with a wide range of accessories Metabo sanders are able to finish a whole host of materials, be it wood, metal, paints, varnish or filler. **Metabo. Work. Don't play.**





CONSIDERED THE BEST, NOT ONLY ON THE SURFACE.

The Metabo range of sanders are considered amongst the best in the industry. Copied by many and perfected by none the Metabo sanding range gives you a choice of machines built to the demands of the profes-

sional. Be it for fine finishing, detail finishing, high stock removal or surface preparation Metabo has the sander and accessory to perfect the job in hand time and time again.

Ergonomic design
Safe and comfortable work as it fits perfectly in the hand.

Electro-dynamic balancing system
Fatigue-free work due to especially low vibrations.

Solid aluminium die cast bearing flange
Guarantees a longer service life of the machine.

Four quality ball bearings protected ideally against dust
Longer service life due to ideal dust protection.

External dust extraction or extraction by Intec filter system possible (accessory)

Quick clamping system
For the fast and comfortable change of the sanding sheet.

Die-cast aluminium oscillating plate
More robust material provides longer service life.

Sanding up to the outermost corner
Oscillating plate without protruding parts.



Metabo power control system
A built-in backing pad brake limits scratches when placing the tool on the material. This means that no manual post-processing is needed. This makes the disc sander particularly suitable for sanding very thin materials and sensitive surfaces.

Unique Duo oscillating circuit setting
Two adjustment options provide 100% finer surfaces with the small oscillating circuit diameter and 70% more material removal with the large one.

DSE 300 Intec – the first triangular base-plate sander with integrated dust extraction unit
No obstructive suction hose; the dust is collected in the integrated dust container.

Which sanding machine for which application?





Application	Type and output	Page
Delta sander with comfortable one-hand operation and dust extraction unit. Low weight with good material removal. Suitable for sanding at places difficult to reach such as corners, edges, intermediate spaces.	FMS 200 Intec 200 W	154
Disc sander with comfortable one-hand operation and dust extraction unit. Grinding at places difficult to reach such as corners, profiles, edges, intermediate spaces. Suitable for grinding heat-sensitive materials and surfaces. Removal of carpet or tile adhesive (with scraper, accessory).	DSE 300 Intec 300 W	154
Particularly suitable for sanding inner and outer curves. Small backing pad diameter and low housing shape for sanding at places difficult to reach. Suitable for sanding heat-sensitive materials and surfaces.	SX E 400 220 W	156
Disc sander with comfortable one-hand operation and dust extraction unit. Low weight with good material removal. Suitable for sanding wood, plastic and metal on even and slightly curved surfaces.	FSX 200 Intec 200 W	156
Large material removal and finest sanding on even and curved surfaces. Suitable for sanding wood, plastic and metal on even and slightly curved surfaces. Intec dust extraction unit.	SXE 325 Intec 250 W	157
Substantial material removal and finest grinding finish on even and domed surfaces. Suitable for sanding heat-sensitive materials and surfaces. Grinding of very thin materials (e.g. veneers).	NEW SXE 425 TurboTec 320 W	157
Universal applications due to Duo-oscillating circuit setting. Large material removal and finest grinding on even and curved surfaces. Suitable for sanding heat-sensitive materials and surfaces. Grinding of very thin materials (e.g. veneers).	NEW SXE 450 TurboTec 350 W	159
Sander with comfortable one-hand operation and dust extraction unit. Low weight with good material removal. Suitable for sanding wood, plastic and metal on even and slightly curved surfaces.	FSR 200 Intec 200 W	160
Robust sander, designed for commercial use. Sanding of wood, plastic, metal, stone on even or slightly curved surfaces. With integrated dust extraction unit for dust-free work without suction hose.	SR 10-23 Intec 200 W	160
Sanding of wood, plastic, metal, stone on even or slightly curved surfaces. Excellent weight-output ratio for hard and long hours of working, as well as working overhead.	SR 20-23 210 W	160
Fine sanding results when sanding wood, plastic, metal and stone. Sanding on even or slightly curved surfaces. Clean work with integrated sanding dust extraction.	Sr 356 350 W	161
Like SR 356, however with large sanding disc for quicker material removal.	Sr 358 350 W	161
Fine sanding results when sanding wood, plastic, metal and stone. Sanding on even or slightly curved surfaces. Suitable for sanding heat-sensitive materials and surfaces. Clean work with integrated sanding dust extraction.	Sr E 357 350 W	161
Like SR E 357, however with large sanding disc for quicker material removal.	Sr E 359 350 W	161
For sanding large, even areas. For sanding notches and for working close to edges. Suitable for sanding heat-sensitive materials and surfaces. Can also be used as fixed tool.	Ba E 1075 1.000 W	163

FOR THE FMS 200 INTEC

Velcro-faced base-plates		Order no.
	Sanding plate, perforated Sanding plate for FSR 200 Intec (as spare) Dimensions: 147 x 100 mm	6.25600
Dust collection box		Order no.
	Dust collector cartridge Dust collector cartridge including dust filter 6.25602	6.25601
	Pleated filter Pleated filter, polyester, for dust collector cartridge (6.25601)	6.25602
	Connector ■ Connector Ø 35 mm for connecting to a normal vacuum cleaner	6.26996

FOR FOR DSE 300 INTEC

Velcro-faced base-plates		Order no.
	Perforated velcro-faced base-plate For the triangular base-plate sanders DSE 300 and DSE 300 Intec (as spare) Dimension from corner to corner: 90 mm	6.24992
	special louvre base-plate Velcro-faced at the bottom side. The self-adhesive velcro-faced liner supplied can be fitted to the top of this base-plate so that cling-fit sanding sheets can be fitted for top and bottom sanding of louvres.	6.24971
	Self-adhesive liner Self-adhesive velcro-faced liner (as spare for special louvre base-plate 6.24971)	6.24972
	Cling-fit abrasive nylon web, corundum abrasive Grit: P 100 Grit: P 280	6.24958 6.24959
	Cling-fit cleaning nylon web	6.24957
	Cling-fit polishing felt ■ Hard	6.24949

Scraper blade		
■ For easy removal of old paint, glue, and other residues		
	Blade width mm	Order no.
	30	6.31662
	50	6.31663
	70	6.31664
	50	Carbide-tipped 6.31661

	Order no.
	Spatula Made of spring sheet-steel Blade width: 60 mm

Dust extraction accessories		Order no.
	Dust collector cartridge ■ For dust extraction unit with DSE 300 Intec	6.24993
	10 dust filters For the dust collector cartridge 6.24993 of the DSE 300 Intec	6.24995
	Extraction nozzle ■ For external extraction for DSE 300/ DSE 300 Intec	6.24994
	Suction hose ■ Connector with internal Ø 30 mm and connector with outer Ø 35 mm Hose length: 5 m Suction hose Ø: 19 mm	6.31592
	Adapter ■ For connecting the suction hose with connector Ø 35 mm to an extraction nozzle Ø 30 mm	6.24996
	Connector ■ For connecting suction hose 6.31592 (Ø 30/35 mm connection) to a household vacuum cleaner	6.31593

Other accessories		Order no.
	Carry case	6.25447

ANGLE GRINDERS

METAL PROCESSORS

HAMMERS

IMPACT DRILLS

DRILLS

SCREWDRIVERS

WOOD SANDING MACHINES

ROUTERS AND PLANERS

EQUIPMENT FEATURES

- Multi-purpose machine for sanding even and cambered surfaces, wood, plastics, non-ferrous metals, sheet steel
- Variospeed (V) electronics
- Thumbwheel for preselection of speed
- Limit scratches while placing the running machine on the material (Power Control System)
- Dust-proof ball bearing
- Velcro-faced backing pad
- Dust extraction unit with Intec filter system, with washable filter cartridge

EQUIPMENT FEATURES

- TurboBoost switch: allows additional power reserves to be employed for achieving maximum removal
- Multi-purpose machine for sanding even and cambered surfaces, wood, plastics, non-ferrous metals, sheet steel
- Rotating and additional oscillating movement of backing pad for optimum finish
- Variospeed (V) electronics
- Thumbwheel for preselection of speed
- Limit scratches while placing the running machine on the material (Power Control System)
- Removable front handle
- Dust-proof ball bearing
- Sturdy aluminum die cast bearing housing
- Velcro-faced backing pad
- Vibration damping, non-slip rubber support on the machine housing and the handle
- Dust extraction unit with Intec filter system, with washable filter cartridge
- External dust extraction outlet



SXE 325 Intec



SXE 425 TurboTec

NEW

	250-Watt Electronic Disc Sander SXE 325 Intec
Comparative device characteristics	
Diameter of backing pad	125 mm
No load speed	5.000 - 11.000 /min
Rated input power	250 W
Output power	100 W
Rated load speed	7.500 /min
Oscillating circuit	5 mm
Weight (without mains cable)	1,7 kg
Standard equipment	3 perforated cling-fit sanding sheets, allen key, dust collector cartridge, 1 pleated filter, carry case
Type	SXE 325 Intec
Order no.	6.00325

	320 Watt Electronic Disc Sander SXE 425 TurboTec
Comparative device characteristics	
Diameter of backing pad	125 mm
No load speed	12600 /min
Rated input power	320 W
Output power	160 W
Rated load speed	9.000 /min
Oscillating circuit	5 mm
Weight (without mains cable)	2 kg
Standard equipment	Velcro-faced backing pad, 3 perforated cling-fit sanding sheets, allen key, removable side handle, dust collector cartridge, 1 pleated filter
Type	SXE 425 TurboTec
Order no.	6.00131 ■

ANGLE GRINDERS

METAL PROCESSORS

HAMMERS

IMPACT DRILLS

DRILLS

SCREWDRIVERS

WOOD SANDING MACHINES

ROUTERS AND PLANERS

FOR SX E 400

	Order no.
 Velcro-faced backing pad Diameter: 80 mm Hardness: Medium-hard Version: Perforated	6.24064
 Backing pad, for self-adhesive sanding discs Diameter: 80 mm Hardness: Medium Version: Perforated	6.24062
 Velcro-faced intermediate disc For sanding curved surfaces Diameter: 80 mm Hardness: Soft Version: Perforated	6.24061
 Cling-fit polishing sponge Diameter: 80 mm Thickness: 20 mm Packing unit: 1	6.24092
 Cling-fit lambswool polishing disc Diameter: 85 mm Packing unit: 1	6.24063
 Cling-fit abrasive nylon web Diameter: 80 mm Grit: P 100 Packing unit: 2	6.24067
 Cling-fit abrasive nylon web Diameter: 80 mm Grit: P 280 Packing unit: 2	6.24068

FOR FSX 200 INTEC, SXE 325 INTEC AND SXE 425 TURBOTEC

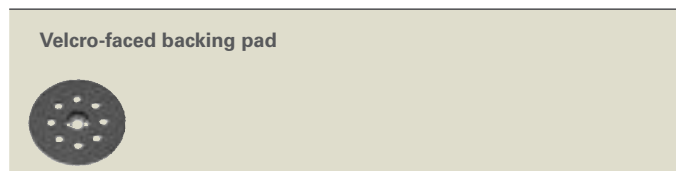

Dia- meter mm	Hardness	Version	Suitable for machine	Order no.
122	Medium	Perforated	FSX 200 Intec	6.25658
125	Soft	Perforated	Backing pad, diameter 125 mm	6.31220
125	Medium-hard	Perforated	Backing pad, diameter 125 mm	6.31219



	Order no.
 Velcro-faced intermediate disc Diameter: 125 mm Hardness: Soft Version: Not perforated	6.31216
 Cling-fit polishing sponge Diameter: Ø 130 mm	6.31222
 Cling-fit lambswool polishing disc Diameter: 130 mm	6.31223
 Cling-fit polishing felt, hard Diameter: 130 mm Thickness: 5 mm	6.31242

 Cling-fit abrasive nylon web Diameter: 125 mm Grit: P 100	6.31238
 Cling-fit abrasive nylon web Diameter: 125 mm Grit: P 280	6.31239
 3 cling-fit abrasive meshes ■ For sanding/grinding gypsum boards Diameter: 125 mm Grit: P 100 Packing unit: 3	6.31215

FOR FSX 200 INTEC

Dust extraction		Order no.
 Dust collector cartridge Dust collector cartridge including dust filter 6.25602		6.25601
 Pleated filter Pleated filter, polyester, for dust collector cartridge (6.25601)		6.25602
 Connector ■ Connector Ø 35 mm for connecting to a normal vacuum cleaner		6.26996

FOR SXE 325, SXE 425 TURBOTEC AND SXE 450 TURBOTEC

	Order no.
 Dust collector cartridge Can be cleaned several times with pleated filter 6.31980 For SXE 325 (as spare)	6.31981
 Dust collector cartridge Can be cleaned several times with pleated filter 6.31980 For SXE 425 TurboTec and SXE 450 TurboTec (as spare)	6.25599
 Pleated filter Polyester (as spare), for the dust collection box (6.31981 and 6.25599)	6.31980
 Dust bag holder, complete As spare, with 1 dust bag	6.31289
 Dust bag Without dust bag holder 6.31289, as spare, pack of 5	6.31288
 Dust bag Can be used in the dust bag holder (6.31289) instead of the paper dust bag provided (6.31288)	6.31758
 Carry case For SXE 425, SXE 425 XL, SXE 450 Duo	6.23894

EQUIPMENT FEATURES

- TurboBoost switch: allows additional power reserves to be employed for achieving maximum removal
- Multi-purpose machine for sanding even and cambered surfaces, wood, plastics, non-ferrous metals, sheet steel
- Rotating and additional oscillating movement of backing pad for optimum finish
- Variospeed (V) electronics
- Thumbwheel for preselection of speed
- Limit scratches while placing the running machine on the material (Power Control System)
- "Duo" Oscillating circuit setting for finishing or more cut
- Removable front handle
- Dust-proof ball bearing
- Sturdy aluminum die cast bearing housing
- Velcro-faced backing pad
- Vibration damping, non-slip rubber support on the machine housing and the handle
- Dust extraction unit with Intec filter system, with washable filter cartridge
- External dust extraction outlet



SXE 450 TurboTec
NEW



350 Watt Electronic Disc Sander SXE 450 TurboTec	
Comparative device characteristics	
Diameter of backing pad	150 mm
No load speed	13100 /min
Rated input power	350 W
Output power	180 W
Rated load speed	8.500 /min
Oscillating circuit	2,8/6,2 mm
Weight (without mains cable)	2,2 kg
Standard equipment	Velcro-faced backing pad, 3 perforated cling-fit sanding sheets, allen key, removable side handle, dust collector cartridge, 1 pleated filter
Type	SXE 450 TurboTec
Order no.	6.00129 ■

ACCESSORIES FOR SXE 450 TURBOTEC

Velcro-faced backing pad			
Diameter mm	Hardness	Version	Order no.
150	Medium-hard	Perforated (6 holes)	6.31158
150	Soft	Perforated (6 holes)	6.31156
150	Medium-hard	Perforated (6 or 8 holes)	6.31150
Backing pad, for self-adhesive sanding discs			
Diameter mm	Hardness	Version	Order no.
150	Medium	Perforated (6 holes)	6.31169
Velcro-faced intermediate disc			
			Order no.
	Velcro-faced intermediate disc For sanding curved surfaces Velcro-faced intermediate disc, for machining curved areas Diameter: 150 mm Hardness: Soft Version: Not perforated		6.24037
Additional accessories for SXE 450 TurboTec			
			Order no.
	Cling-fit polishing sponge Diameter: 160 mm Packing unit: 1 Suitable for machine: Backing pad, diameter 150 mm		6.31233
	Cling-fit lambswool polishing disc For high-gloss polishing Suitable for: System 150 mm Diameter: 160 mm Packing unit: 1		6.31217
	Cling-fit polishing felt Diameter: 150 mm Thickness: 5 mm		6.31168
	Cling-fit abrasive nylon web Diameter: 150 mm Grit: P 100 Diameter: 150 mm Grit: P 280		6.24038 6.24039
			Order no.
	Carry case For SXE 425, SXE 425 XL, SXE 450 Duo		6.23894
	Metabox III For SX E 425 Turbo Tec, SX E 450 Turbo Tec For SX E 450 Duo, SX E 425 XL		6.24619

Accessories for the dust intake action are to be found on page 158.

ANGLE GRINDERS
METAL PROCESSORS
HAMMERS
IMPACT DRILLS
DRILLS
SCREWDRIVERS
WOOD SANDING MACHINES
ROUTERS AND PLANERS

EQUIPMENT FEATURES

- Universal use for sanding wood, plastics, metals, stone and varnished surfaces
- Light and handy machine for convenient one-hand operation
- Very good weight-performance ratio
- Vibration-damping, non-slip rubber coated handle
- Dust-proof ball bearing
- Velcro-faced base plate and clamp fixture
- Dust extraction unit with Intec filter system, with washable filter cartridge

COMMON FEATURES

- Universal use for sanding wood, plastics, metals, stone and varnished surfaces
- Robust sander with long service life even under tough conditions
- Very good weight-performance ratio
- High material removal
- Even sanding pattern with high class base plate made of microcellular polyurethane elastomere
- Especially vibration-free by electrodynamic fine balancing
- 4 high quality oscillating buffers and dust-proof quality ball bearing for long service life with continuous use
- Sturdy aluminum die cast oscillating plate
- Unique clamping system enables quick and comfortable change of sanding sheet
- Sanding possible up to the outermost corner
- External dust extraction outlet
- Auto-stop carbon brushes



FSR 200 Intec



SR 10-23 Intec

SR 20-23

	200 Watt Palm Grip Sander FSR 200 Intec
Comparative device characteristics	
Base plate	114 x 102 mm
Orbital frequency at no-load	26.000 /min
Rated input power	200 W
Output power	80 W
Orbital frequency at rated load	22.000 /min
Oscillating circuit	1,4 mm
Weight (without mains cable)	1,25 kg
Standard equipment	3 cling-fit sanding sheets (perforated), dust collector cartridge, 1 pleated filter, carry case
Type	FSR 200 Intec
Order no.	6.00066 ■

	200 Watt Sander SR 10-23 Intec	210 Watt Sander SR 20-23
Special advantages		
■ Designed for continuous commercial use		•
■ Solid aluminium die cast bearing flange		•
■ Dust extraction unit with Intec filter system, multiple cleaning	•	
■ Dust extraction unit with Intec filter system, can be retrofitted as accessory		•
Comparative device characteristics		
Base plate	92 x 183 mm	92 x 183 mm
Orbital frequency at no-load	21.700 /min	21.700 /min
Rated input power	200 W	210 W
Output power	90 W	95 W
Orbital frequency at rated load	18.000 /min	16.000 /min
Oscillating circuit	2,5 mm	2,5 mm
Weight (without mains cable)	1,75 kg	1,8 kg
Standard equipment	2 sanding sheets (perforated), dust collector cartridge, 1 pleated filter	2 sanding sheets (perforated)
Type	SR 10-23 Intec	SR 20-23
Order no.	6.01024	6.02026 ■

COMMON FEATURES

- Universal use for sanding wood, plastics, metals, stone and varnished surfaces
- Powerful motor with high capacity reserve
- Even sanding pattern with high class base plate made of microcellular polyurethane elastomere
- Especially vibration-free by electrodynamic fine balancing
- 4 high quality oscillating buffers and dust-proof quality ball bearing for long service life with continuous use
- Solid aluminium die cast bearing housing
- Sturdy aluminum die cast oscillating plate
- Quick-grip clamping with rubber-coated pressure pad
- Sanding possible up to the outermost corner
- Dust extraction unit
- Dust bag holder with dust retaining flap
- External dust extraction outlet
- Auto-stop carbon brushes



Sr 356

Sr 358





Sr E 357

Sr E 359

	350 Watt Sander Sr 356	350 Watt Sander Sr 358	350 Watt Electronic Sander Sr E 357	350 Watt Electronic Sander Sr E 359
Special advantages				
■ Variospeed (V) electronics			•	•
■ Thumbwheel for preselection of orbital frequency			•	•
Comparative device characteristics				
Base plate	92 x 190 mm	112 x 230 mm	92 x 190 mm	112 x 236 mm
Orbital frequency at no-load	22.000 /min	22.000 /min	12.000 - 22.000 /min	12.000 - 22.000 /min
Rated input power	350 W	350 W	350 W	350 W
Output power	190 W	190 W	190 W	190 W
Orbital frequency at rated load	15.000 /min	15.000 /min	15.000 /min	15.000 /min
Oscillating circuit	2,5 mm	2,5 mm	2,5 mm	2,5 mm
Weight (without mains cable)	2,5 kg	2,7 kg	2,6 kg	2,8 kg
Standard equipment	3 sanding sheets (perforated), removable side handle, dust bags (paper), dust bag holder	3 sanding sheets (perforated), removable side handle, dust bags (paper), dust bag holder	3 sanding sheets (perforated), removable side handle, dust bags (paper), dust bag holder	3 sanding sheets (perforated), removable side handle, dust bags (paper), dust bag holder
Type	Sr 356	Sr 358	Sr E 357	Sr E 359
Order no.	6.00356 ■	6.00358 ■	6.00357 ■	6.00359 ■

ANGLE GRINDERS
METAL PROCESSORS
HAMMERS
IMPACT DRILLS
DRILLS
SCREWDRIVERS
WOOD SANDING MACHINES
ROUTERS AND PLANERS

PERFORATED VELCRO-FACED BASE-PLATES

For the palm grip sander FSR 200 Intec		Order no.
	<ul style="list-style-type: none"> Perforated, velcro-faced sanding plate FSR 200 Intec (as spare) Length: 114 mm Width: 112 mm 	6.25657
For the Sr 356 and Sr E 357 sanders		Order no.
	<ul style="list-style-type: none"> The base-plate of sanders Sr 356/Sr E 357 can be replaced by the velcro-faced base-plate Length: 185 mm Width: 92 mm 	6.24736
For the Sr 358 and Sr E 359 sanders		Order no.
	<ul style="list-style-type: none"> The base-plate of sanders Sr 358/Sr E 359 can be replaced by the velcro-faced base-plate Length: 230 mm Width: 112 mm 	6.24749
Self-adhesive velcro-faced liner for the Sr 356 and Sr E 357 sanders		Order no.
	<ul style="list-style-type: none"> The perforated liner is stuck onto the sanding plate of sanders. The sanding plate should be free of dust and grease before applying the adhesive liner. Length: 191 mm Width: 93 mm 	6.24709



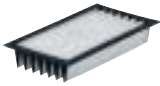

DUST EXTRACTION ACCESSORIES

For the palm grip sander FSR 200 Intec		Order no.
	<ul style="list-style-type: none"> Dust collector cartridge Dust collector cartridge including dust filter 6.25602 	6.25601
	<ul style="list-style-type: none"> Pleated filter Pleated filter, polyester, for dust collector cartridge (6.25601) 	6.25602
	<ul style="list-style-type: none"> Connector Connector Ø 35 mm for connecting to a normal vacuum cleaner 	6.26996

For the sanders SR 10-23, SR 10-23 Intec and SR 20-23

	Order no.
 Dust collector cartridge Can be cleaned several times with pleated filter 6.31980 Included in delivery with SR 10-23 Intec	6.31981
 Pleated filter Polyester (as spare), for the dust collection box (6.31981)	6.31980



For the sanders Sr 356, Sr E 357, Sr 358 and Sr E 359

	Order no.
 Dust bag holder, complete As spare, with 1 dust bag	6.31289
 Dust bag Without dust bag holder 6.31289, as spare, pack of 5	6.31288
 Dust bag Can be used in the dust bag holder (6.31289) instead of the paper dust bag provided (6.31288)	6.31758
 Paper dust bag, complete Sawdust bag (paper) with connector (as spare)	6.31385
 Dust bag Without dust bag holder 6.31385, as spare, pack of 5	6.31286

Hoses

	Order no.
 Suction hose With connector Ø 58 mm for bayonet fitting and rubber connector (internal Ø 30 mm, outside Ø 35 mm) Hose length: 3,5 m	6.31938

Carry cases

	Order no.
 Sheet steel carry case For Sr 226, Sr E 227, Sr 356, Sr E 357, Sr 358, Sr E 359	6.31396
 Carry case For SR 10-23, SR 10-23 Intec, SR 20-23	6.25448

EQUIPMENT FEATURES

- Powerful and loadable motor with high reserve capacity
- Fast and easy sanding belt change
- Very good polished section by extremely precise belt path
- Excellent sanding results and comfortable operation by favourable centre of gravity position of the motor
- Metabo S-automatic torque limiting clutch
- Variospeed (V) electronics
- Thumbwheel for preselection of belt speed
- Auto-stop carbon brushes
- Side handle for ideal machine guidance
- Dust extraction unit
- External dust extraction outlet
- Suitable for stationary use



Ba E 1075

**1000 Watt
Electronic
Belt Sander
Ba E 1075**

Comparative device characteristics

Torque	7 Nm
Sanding/grinding width	75 mm
Sanding belt supporting surface	75 x 125 mm
No-load belt speed	200 - 380 m/min
Rated input power	1.000 W
Rated load belt speed	320 m/min
Weight (without mains cable)	3,8 kg

Standard equipment

Dust bag, 1 sanding belt P 100, side handle, suction adapter, base for fixed use

Type
Order no.

Ba E 1075
6.01075

Accessories

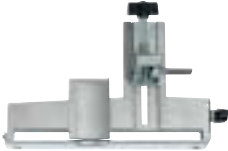
	Order no.
 <p>Sanding frame ■ For accurate sanding of flat surfaces with the belt sander Ba E 1075</p>	6.31033
 <p>Length guide ■ For stationary use of the sander, can be tilted up to 45° for sanding bevels</p>	6.31032
<p>Bases for sanding belt Made from graphite-coated fabric Packing unit: 2</p>	6.31034
<p>Base for sanding belt Comprising: spring sheet-steel with cork lining for rough grinding work with rapid material removal Packing unit: 1</p>	6.31037



ANGLE GRINDERS

METAL PROCESSORS

HAMMERS

IMPACT DRILLS

DRILLS

SCREWDRIVERS

WOOD SANDING MACHINES

ROUTERS AND PLANERS

SOUND ARGUMENTS.

A quality machine also needs a quality accessory. For sanders a wide range of accessories are required to give the best finish for a wide range of materials. Be it for wood, metal, stone, paint, varnish or filler Metabo has the

right accessory for the machine and the material. At Metabo we do not just make accessories for our own machines but for other manufactures as well.

Structure and purpose of Metabo abrasive mediums



The sanding compound

carries the grains and transfers the chip removal forces. Besides high strength and small expansion, the sanding compound has to render a sanding process matching flexibility .

Carriers are

- Highly compressed papers of various thicknesses.
- Fabric based on polyester and cotton wool of various strengths.
- Vulcanized fibre as a strong and tear-proof base is the base material for the (Vulcan) fibre disc.

The abrasive grain

is the actual sanding tool. It penetrates the material to be worked on and removes the surface. The abrasive grain is anchored on the grain-holding medium. High hardness, toughness and a sharp edged geometry are the most important attributes of the abrasive grain.

For top quality sanding medium only synthetic abrasive grain materials are used.

Abrasive grain types are

- Corundum (Aluminiumoxide) as a hard, slightly brittle grain for the processing of metal, wood, lacquers... of rough- and fine ground finishes.
- Silicon carbide as a hard, sharp-edged abrasive grain for processing of lacquer, wood, ceramic, glass, rubber... for rough and fine ground finish.
- Aluminous zircon as a tough and fine crystalline combination of Aluminiumoxide and aluminous zircon for the processing of metal and non-rusting materials.

The bonding agent

anchors the abrasive grain in the sanding compound carrier and supports it against the forces generated by the removal of the surface material.

Bonding agents are

- Phenolic resins and partially synthetic resins for sufficient support with a certain elasticity.

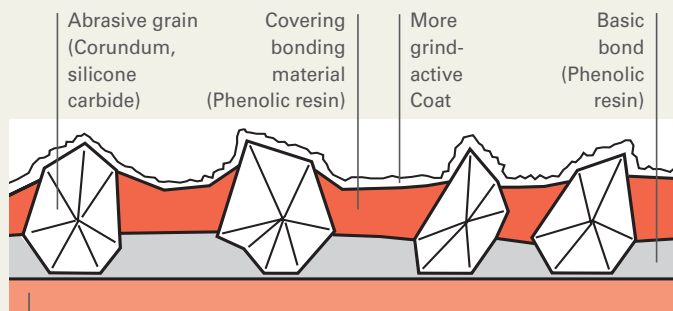

Sanding compound carrier: Paper, fabric, fibre or a P-G-combination

The quality of Metabo sanding mediums

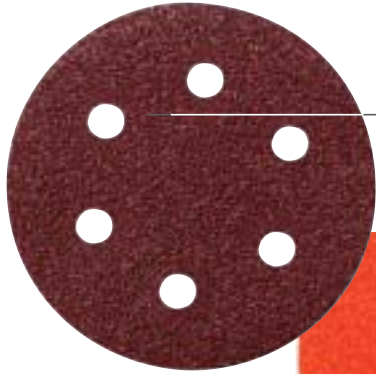

for example for orbital sander:

Wood + metal / wood + metal "professional"

E-paper, pink aluminium oxide, resin bonded

- High quality grinding paper with dense dispersion and high material removal rate
- For the best results when sanding wood and metal in professional application

Application:

- For veneers, solid wood, steel- and special steel sheeting, NE-special steels, light metals. e.g. for sanding veneered and foil covered furniture parts with hot-melt glue edging, decor sanding on special steel sheeting, refurbishment sanding and deburring of sheet edges

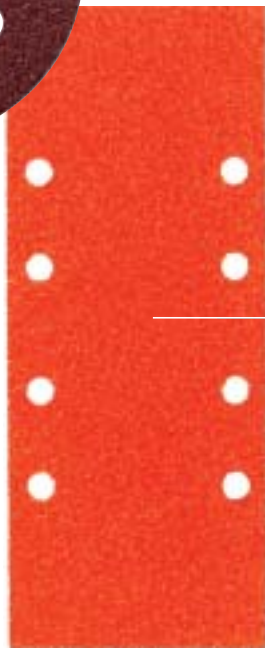

for example for disc sander:

Wood / wood „classic“

A-/B-Paper, normal corundum, resin-/glue bond

- High quality sanding paper with half-open grain distribution
- Best suited for sanding of wood with an outstanding price-performance ratio.

Application:

- For wood generally, solid wood, veneers, plastic, acrylic glass, lacquer, spatula, fillers, e.g. for deburring, cleaning of plywood, veneer-, solid wood, lacquered surfaces, deburring of veneered furniture edges

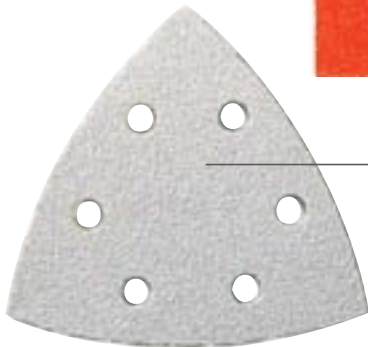

for triangular base-plate sanders:

Paint / paint „professional“

B-/C-Paper, pink grade corundum, stearate-coated, resin bonded

- High quality sanding paper with medium-dense grain dispersion and a high material removal rate
- The special stearate coating ensures a long service life by not clogging the sanding medium
- For best results when sanding off paint, lacquer, body-filler on wood or metal on professional application

Application:

- To deburr and clean veneer, solid wood, ply-wood and lacquered surfaces, deburring of veneered furniture edges

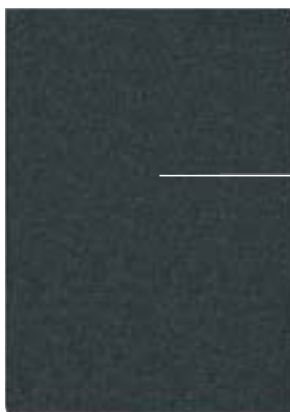

Special / special „expert“

C-paper/ latex, silicone carbide, synthetic resin bonded, waterproof

- High quality sanding paper with dense grain distribution
- For best results in a professional as well as in a domestic environment. Ideal for wet-sanding of primed surfaces in body-workshops and on motorcar repairs

Application:

- Especially for extremely hard surfaces, filler coat, filler, lacquers of all types e.g. when wet-sanding of primed surfaces and roughing up of all lacquered surfaces

Which sanding medium for which machine and for which manufacturer?

SANDING SHEETS FOR TRIANGULAR BASE-PLATE SANDERS

93 mm, 6 holes, velcro		Metabo DSE 130 DSE 170 DSE 300 / Intec Bosch GDA 280 E PDA 100 PDA 120E PDE 180 / E PDA 240E PSM 160 Casals BLD 180 VLD 230 Makita BO 4561
---------------------------	--	---

95 mm, 6 holes, velcro		Festo DX 93E/E Plus
---------------------------	--	---------------------

100 x 150 mm, 7 holes, velcro		Festo DS 400/E/EQ
----------------------------------	---	-------------------

100 x 150 mm, 11 holes, velcro		Metabo FMS 200 Intec Bosch PSM 160 A PSM 80 A PRIO
-----------------------------------	--	---

105 mm, 6 holes, velcro		AEG DSE 220 DSE 260
----------------------------	--	------------------------

120 mm, 6 holes, velcro		Kress CDS 280 DSXL CDS 6425 EXL
----------------------------	--	------------------------------------

SANDING SHEETS FOR DISC SANDERS

115 mm, 8 holes, velcro		Bosch PEX11A/AE PEX 115 Einhell EX 115 Kress CPS 6115-1/E Peugeot PAE 115 Skil 7415 Stayer LRT 115 Metabo FSX 200 Intec SXE 125 SXE 425 AEG EX 400 EX 450 EXE 400 Atlas Copco TXE 150
----------------------------	--	--

125 mm, 8 holes, velcro

	Bosch GEX 125A / AC PEX 12A / AE PEX 125A - 1 PEX 125 AE PEX 400AE De Walt DW 423 Elu ES 55E Fein MSF 636-1 Festo ES 125 / E Hitachi TSV 13Y Kress CPS 6125-1 / E HEX 6385E HEX 1385E Skil 7400 7425 7430 7435 Wegoma LRE 84H
---	--

150 mm, 6 holes, velcro

	Metabo SXE 425 XL SXE 450 DUO Bosch GEX 150AC/ACE PEX 15AE PEX 420 AE DeWalt DW 443 Elu ES 56E/EK Felisatti TP 521AS/EAS TP 522 AS Hilti WFE 380 WFE 450E Hitachi SAY 150A Kress 900 HEX Milwaukee ROS 150 E Peugeot PRX 150E Stayer LRT 150 RO 150 Wegoma RX 91 C
---	---

150 mm, 8 holes, velcro

	AEG EXE 450 Casals VEX 150 E Fein MSF 636-1 MSF 649-2A/-2B Makita BO 6030 BO 6040
---	--

150 mm, 9 holes, velcro

	Festo ET 2E RO 150E ES 150/3 EQ/C ES 150/5 EQ/C ProTool ESP 150 E
---	---

150 mm, 16 holes, velcro

	AEG EX 450 EXE 450 Atlas Copco TXE 150 Fein MSF 649-2A /-2B Holz Her 2445
---	---

SANDING SHEETS FOR SANDERS

80 x 133 mm, 8 holes, velcro		Atlas Copco VS 11 Black&Decker P 63-01 Bosch GSS 16 A Felisatti TP 31 E Festo RS 4 / E / STF Hitachi SV 8 SA
---------------------------------	---	---

80 x 166 mm, 8 holes, tightened		Atlas Copco VS 11 Black&Decker P 63-01 Bosch GSS 16A Hitachi SV 8 SA Wegoma LRE 84H
------------------------------------	---	---

93 x 178 mm, 8 holes, velcro		Festo LRS 93G LRS 93M RS 3/E RS 4/E/STF
---------------------------------	---	--

93 x 185 mm, 8 holes, velcro		Metabo SR 356 SR 357 SR4350 Atlas Copco VS 230/E VSS 22/E VSS 260/E Bosch GSS 23 AE GSS 230 A/AE PSS / A/AE PSS 180A PSS 240A/AE Casals KLR 210 Einhell EST 170 Festo RS 3 SFE/E Hitachi FS 10 SB Makita 9036 Peugeot PV 240 A TV 4102 Skil 7300/S 7390 7395 Black&Decker KA 175 KA 186/E
---------------------------------	---	---

93 x 230 mm, 8 holes, tightened	
	Metabo SR 10-23
	SR 10-23 Intec
	SR 20-23
	SR 226
	SR 356
	SR 4350
	SRE 227
	SRE 357
	Atlas Copco VS 230
	VSE 230
	VSS 260
	VSSE 260
	Black&Decker BD 175
	BD 180 E
	CD 400
	DN 41 AE
	DN 180E
	KA 196
	Bosch GSS 23/AE
	GSS 230A/AE
	PSS 23/A/AE
	PSS 230
	PSS 240A/AE
	Festo RS 3 SFE
	RS 3E SFE
	Makita 9036
	3700
	Peugeot PV 240 A
TV 4102	
Ryobi NS 401	
NS 801	
S 35	
Skil 7300	
7330 S	
7385	
7390	
7395	

93 x 230 mm, 8 holes, tightened	
	AEG VS 230
	VSS 260/E
	Black&Decker KA 185
	KA 185E

93 x 280 mm, 8 holes, tightened Velcro for extended grinding disc	
	Bosch GSS 23AE
	GSS 230 A/AE

115 x 103 mm, 6 holes, velcro	
	Metabo FSR 200 Intec
	Makita BO 4553 / 4554
	Hitachi SV 12 SF

115 x 107 mm, 6 holes, velcro	
	Bosch GSS 140 A

115 x 115 mm, 8 holes, velcro	
	Metabo SRA 60
	SRE 217
	Hitachi SV 12 SF
	Makita 4554

115 x 140 mm, 6 holes, tightened	
	Metabo FSR 200 Intec
	Makita BO 4553/4554
	Hitachi SV 12 SF

115 x 140 mm, 8 holes, tightened	
	Black&Decker SR 400
	Bosch GSS 9,6V
	GSS 140 A
	DeWalt DW 411
	Makita BO 4553
	BO 4554
	BO 4556
	Ryobi S 605 D
	Skil 7576U

115 x 230 mm, 14 holes, velcro	
	Metabo SR 358
	SR 4351
	SRE 359
	Atlas Copco VS 280/E
	VS 280/SE
	VSE 230
	VSS 20 E
	Black&Decker KA 273
	Bosch GSS 28/A/AE
	GSS 280A/AE
	PSS 28 AE
	PSS 280AE
	Casals BLR 250
	VLR 300
	Einhell ERU 270
	Elu VS 41
	VS 71
	Festo RS 1 STF
	RS 2 STF/E
	Hitachi SV 12SD/V
	Kress CRS 6165A
	CRS 6175EA
	Makita 9045B/N
	9046
	Peugeot TV 4003
	TV 4103
	Ryobi NS 6200
	NS 6300 A
	Skil 666

115 x 280 mm, 14 holes, tightened	
	Metabo SR 328
	SR 4321
	SRE 329
	Atlas Copco VS 280/E
	VS 280/SE
	VSE 230
	VSS 20/E
	Black&Decker BD 273
	DN 41 AE
	KA 273
	P 63-03/-04/-05
	SR 410E
	Bosch GSS 28 A
	GSS 280A/AE
PSS 28AE	
PSS 280AE	

115 x 280 mm, 14 holes, tightened	
	Casals BLR 250
	LN 216
	LR 228
	Elu VS 41 / 71
	Hitachi SV 12 SD/V
	Kress CRS 6165A
	CRS 6175ES
	Makita BO 4900 V
	9046

ANGLE GRINDERS

METAL PROCESSORS

HAMMERS

IMPACT DRILLS

DRILLS

SCREWDRIVERS

WOOD SANDING MACHINES



ROUTERS AND PLANERS

CLING-FIT SANDING SHEETS FOR MULTISANDERS

Cling-fit sanding sheets for wood and metal, "professional" series				
	Dimensions mm	Grit	Packing unit	Order no.
	Cling-fit sanding sheets 100 x 150 mm, 7 holes			
	100 x 150	P 40	25	6.25671
	100 x 150	P 60	25	6.25672
	100 x 150	P 80	25	6.25673
	100 x 150	P 100	25	6.25674
	100 x 150	P 120	25	6.25675
	100 x 150	P 180	25	6.25676
	100 x 150	P 240	25	6.25677
	100 x 150	P 320	25	6.25678

Cling-fit sanding sheets for wood, "classic" series				
	Dimensions mm	Grit	Packing unit	Order no.
	Cling-fit sanding sheets 100 x 150 mm, 11 holes, 2-piece			
	100 x 150	P 40	10	6.25603
	100 x 150	P 60	10	6.25604
	100 x 150	P 80	10	6.25605
	100 x 150	P 100	10	6.25606
	100 x 150	P 120	10	6.25607
	100 x 150	P 180	10	6.25608
	100 x 150	P 240	10	6.25609

	Order no.
10 cling-fit sanding sheets Assortment (2 each of P 60, P 80, P 120, P 180, P 240) Dimensions: 100 x 150 mm Version: Perforated (11 holes, 2-piece)	6.25610

Cling-fit sanding sheets for paints and lacquers, "professional" series				
	Dimensions mm	Grit	Packing unit	Order no.
	Cling-fit sanding sheets 100 x 150 mm, 7 holes			
	100 x 150	P 40	25	6.25701
	100 x 150	P 60	25	6.25702
	100 x 150	P 80	25	6.25703
	100 x 150	P 100	25	6.25704
	100 x 150	P 120	25	6.25705
	100 x 150	P 180	25	6.25706
	100 x 150	P 240	25	6.25707
	100 x 150	P 320	25	6.25708
	Cling-fit sanding sheets 100 x 150 mm, 11 holes, 2-piece			
	100 x 150	P 40	10	6.25611
	100 x 150	P 60	10	6.25612
	100 x 150	P 80	10	6.25613
	100 x 150	P 100	10	6.25614
	100 x 150	P 120	10	6.25615
	100 x 150	P 180	10	6.25616
	100 x 150	P 240	10	6.25617



	Order no.
10 cling-fit sanding sheets Dimensions: 100 x 150 mm Version: Perforated (11 holes, 2-piece)	6.25618

CLING-FIT SANDING SHEETS FOR TRIANGULAR BASE-PLATE SANDERS

Cling-fit sanding sheets for wood and metal, "professional" series				
	Dimensions mm	Grit	Packing unit	Order no.
	Cling-fit sanding sheets 93 x 93 mm, 6 holes			
	93 x 93	P 40	5	6.24940
	93 x 93	P 60	5	6.24941
	93 x 93	P 80	5	6.24942
	93 x 93	P 100	5	6.24943
	93 x 93	P 120	5	6.24944
	93 x 93	P 180	5	6.24945
	93 x 93	P 240	5	6.24946
	93 x 93	P 320	5	6.24947
	93 x 93	P 40	25	6.24980
	93 x 93	P 60	25	6.24981
	93 x 93	P 80	25	6.24982
	93 x 93	P 100	25	6.24983
	93 x 93	P 120	25	6.24984
	93 x 93	P 180	25	6.24985
	93 x 93	P 240	25	6.24986
	93 x 93	P 320	25	6.24987



	Order no.
25 cling-fit sanding sheets Assortment (10 x P 60, 10 x P 80, 5 x P 120) Dimensions: 93 x 93 mm Version: Perforated (6 holes)	6.24988



	Order no.
10 cling-fit sanding sheets Assortment (2 each of P 60, P 80, P 120, P 180, P 240) Dimensions: 100 x 150 mm Version: Perforated (11 holes, 2-piece)	6.25610

Cling-fit sanding sheets for paints and lacquers, "professional" series				
	Dimensions mm	Grit	Packing unit	Order no.
	Cling-fit sanding sheets 93 x 93 mm, 6 holes			
	93 x 93	P 40	25	6.25681
	93 x 93	P 60	25	6.25682
	93 x 93	P 80	25	6.25683
	93 x 93	P 100	25	6.25684
	93 x 93	P 120	25	6.25685
	93 x 93	P 180	25	6.25686
	93 x 93	P 240	25	6.25687
	93 x 93	P 320	25	6.25688
		Cling-fit sanding sheets 95 x 95 mm, 6 holes		
95 x 95		P 40	25	6.25691
95 x 95		P 60	25	6.25692
95 x 95		P 80	25	6.25693
95 x 95		P 100	25	6.25694
95 x 95		P 120	25	6.25695
95 x 95		P 180	25	6.25696
95 x 95		P 240	25	6.25697
95 x 95		P 320	25	6.25698

	Order no.
10 cling-fit sanding sheets Dimensions: 100 x 150 mm Version: Perforated (11 holes, 2-piece)	6.25618

**CLING-FIT SANDING SHEETS
FOR DISC SANDERS**

Cling-fit sanding sheets for wood and metal, "professional" series				
	Diameter mm	Grit	Packing unit	Order no.
	Cling-fit sanding sheets Ø 80 mm, 6 holes			
	80	P 40	10	6.24041
	80	P 60	10	6.24042
	80	P 80	10	6.24043
	80	P 100	10	6.24044
	80	P 120	10	6.24045
	80	P 180	10	6.24046
	80	P 240	10	6.24047
	80	P 320	10	6.24048
	80	P 400	10	6.24049
	80	P 40	25	6.24051
	80	P 60	25	6.24052
	80	P 80	25	6.24053
	80	P 100	25	6.24054
	80	P 120	25	6.24055
	80	P 180	25	6.24056
	80	P 240	25	6.24057
	80	P 320	25	6.24058
	80	P 400	25	6.24059
	Cling-fit sanding sheets Ø 115 mm, 8 holes			
	115	P 40	5	6.26097
	115	P 60	5	6.26098
	115	P 80	5	6.26099
	115	P 100	5	6.26100
	115	P 120	5	6.26101
	115	P 180	5	6.26102
	115	P 240	5	6.26103
	115	P 320	5	6.26104
	115	P 400	5	6.26105
	Cling-fit sanding sheets Ø 125 mm, 8 holes			
	125	P 40	5	6.31226
	125	P 60	5	6.31227
	125	P 80	5	6.31228
	125	P 120	5	6.31229
	125	P 180	5	6.31230
	125	P 240	5	6.31231
	125	P 320	5	6.31236
	125	P 400	5	6.31237
	125	P 40	25	6.31584
	125	P 60	25	6.31585
	125	P 80	25	6.31586
	125	P 120	25	6.31587
	125	P 180	25	6.31588
	125	P 240	25	6.31589
125	P 320	25	6.31596	
125	P 400	25	6.31597	

Diameter mm	Grit	Packing unit	Order no.	
	Cling-fit sanding sheets Ø 150 mm, 6 holes			
	150	P 40	5	6.24001
	150	P 60	5	6.24002
	150	P 80	5	6.24003
	150	P 100	5	6.24004
	150	P 120	5	6.24005
	150	P 180	5	6.24006
	150	P 240	5	6.24007
	150	P 320	5	6.24008
	150	P 400	5	6.24009
	150	P 40	25	6.24019
	150	P 60	25	6.24020
	150	P 80	25	6.24021
	150	P 100	25	6.24022
	Cling-fit sanding sheets Ø 150 mm, 9 holes			
	150	P 40	25	6.25715
	150	P 60	25	6.25716
	150	P 80	25	6.25717
	150	P 100	25	6.25718
	150	P 120	25	6.25719
	150	P 180	25	6.25720
	150	P 240	25	6.25721
	150	P 320	25	6.25722
	150	P 400	25	6.25723

	Order no.
25 cling-fit sanding sheets Assortment (10 x P 60, 10 x P 80, 5 x P 120) Diameter: 80 mm Version: Perforated (6 holes)	6.24060
6 cling-fit sanding sheets Assortment (2 x P 60, 2 x P 120, 2 x P 240) Diameter: 115 mm Version: Perforated (8 holes)	6.26106
6 cling-fit sanding sheets Assortment (2 x P 60, 2 x P 120, 2 x P 240) Diameter: 125 mm Version: Perforated (8 holes)	6.31232
25 cling-fit sanding sheets Assortment (10 x P 60, 10 x P 80, 5 x P 120) Diameter: 125 mm Version: Perforated (8 holes)	6.31583
25 cling-fit sanding sheets Assortment (10 x P 60, 10 x P 80, 5 x P 120) Diameter: 150 mm Version: Perforated (6 holes)	6.24066

Cling-fit sanding sheets for paints and lacquers, "professional" series				
	Diameter mm	Grit	Packing unit	Order no.
	Cling-fit sanding sheets Ø 80 mm, 6 holes			
	80	P 40	25	6.24081
	80	P 60	25	6.24082
	80	P 80	25	6.24083
	80	P 100	25	6.24084
	80	P 120	25	6.24085
	80	P 180	25	6.24086
	80	P 240	25	6.24087
	80	P 320	25	6.24088
	80	P 400	25	6.24089

ANGLE GRINDERS

METAL PROCESSORS

HAMMERS

IMPACT DRILLS

DRILLS





SCREWDRIVERS



WOOD SANDING MACHINES



ROUTERS AND PLANERS

Diameter mm	Grit	Packing unit	Order no.
Cling-fit sanding sheets Ø 115 mm, 8 holes			
115	P 40	5	6.26107
115	P 60	5	6.26108
115	P 80	5	6.26109
115	P 100	5	6.26110
115	P 120	5	6.26111
115	P 180	5	6.26112
115	P 240	5	6.26113
115	P 320	5	6.26114
115	P 400	5	6.26115
Cling-fit sanding sheets Ø 125 mm, 8 holes			
125	P 40	25	6.25726
125	P 60	25	6.25727
125	P 80	25	6.25728
125	P 100	25	6.25729
125	P 120	25	6.25730
125	P 180	25	6.25731
125	P 240	25	6.25732
125	P 320	25	6.25733
125	P 400	25	6.25734
Cling-fit sanding sheets Ø 150 mm, 6 holes			
150	P 40	25	6.24028
150	P 60	25	6.24029
150	P 80	25	6.24030
150	P 100	25	6.24031
150	P 120	25	6.24032
150	P 180	25	6.24033
150	P 240	25	6.24034
150	P 320	25	6.24035
150	P 400	25	6.24036
Cling-fit sanding sheets Ø 150 mm, 9 holes			
150	P 40	25	6.25738
150	P 60	25	6.25739
150	P 80	25	6.25740
150	P 100	25	6.25741
150	P 120	25	6.25742
150	P 180	25	6.25743
150	P 240	25	6.25744
150	P 320	25	6.25745
150	P 400	25	6.25746
			Order no.
25 cling-fit sanding sheets Assortment (10 x P 60, 10 x P 80, 5 x P 120) Diameter: 80 mm Version: Perforated (6 holes)			6.24090
25 cling-fit sanding sheets Assortment (10 x P 60, 10 x P 80, 5 x P 120) Diameter: 115 mm Version: Perforated (8 holes)			6.26116
25 cling-fit sanding sheets Assortment (10 x P 60, 10 x P 80, 5 x P 120) Diameter: 125 mm Version: Perforated (8 holes)			6.25735
25 cling-fit sanding sheets Assortment (10 x P 60, 10 x P 80, 5 x P 120) Diameter: 150 mm Version: Perforated (6 holes)			6.24069



SANDING SHEETS FOR SANDERS / ORBITAL SANDERS



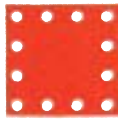
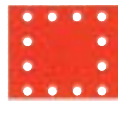

Sanding sheets wood and metal, "professional" series				
	Dimensions mm	Grit	Packing unit	Order no.
Cling-fit sanding sheets 80 x 133 mm, 8 holes, with velcro				
	80 x 133	P 40	10	6.25749
	80 x 133	P 60	10	6.25750
	80 x 133	P 80	10	6.25751
	80 x 133	P 100	10	6.25752
	80 x 133	P 120	10	6.25753
	80 x 133	P 180	10	6.25754
	80 x 133	P 240	10	6.25755
	80 x 133	P 320	10	6.25756
	80 x 133	P 400	10	6.25757
	80 x 133	P 40	25	6.26052
	80 x 133	P 60	25	6.26053
	80 x 133	P 80	25	6.26054
	80 x 133	P 100	25	6.26055
	80 x 133	P 120	25	6.26056
	80 x 133	P 180	25	6.26057
	80 x 133	P 240	25	6.26058
	80 x 133	P 320	25	6.26059
	80 x 133	P 400	25	6.26060
Cling-fit sanding sheets 93 x 185 mm, 8 holes, with velcro				
	93 x 185	P 40	10	6.25765
	93 x 185	P 60	10	6.25766
	93 x 185	P 80	10	6.25767
	93 x 185	P 100	10	6.25768
	93 x 185	P 120	10	6.25769
	93 x 185	P 180	10	6.25770
	93 x 185	P 240	10	6.25771
	93 x 185	P 320	10	6.25772
	93 x 185	P 400	10	6.25773
	93 x 185	P 40	25	6.25775
	93 x 185	P 60	25	6.25776
	93 x 185	P 80	25	6.25777
	93 x 185	P 100	25	6.25778
	93 x 185	P 120	25	6.25779
	93 x 185	P 180	25	6.25780
	93 x 185	P 240	25	6.25781
	93 x 185	P 320	25	6.25782
	93 x 185	P 400	25	6.25783
Sanding sheets 93 x 230 mm, 8 holes, for clamping				
	93 x 230	P 40	10	6.24480
	93 x 230	P 60	10	6.24481
	93 x 230	P 80	10	6.24482
	93 x 230	P 100	10	6.24483
	93 x 230	P 120	10	6.24484
	93 x 230	P 180	10	6.24485
	93 x 230	P 240	10	6.24486
	93 x 230	P 320	10	6.25761
	93 x 230	P 400	10	6.25762
Cling-fit sanding sheets 103 x 115 mm, 6 holes, with velcro				
	103 x 115	P 40	10	6.25619
	103 x 115	P 60	10	6.25620
	103 x 115	P 80	10	6.25621
	103 x 115	P 100	10	6.25622
	103 x 115	P 120	10	6.25623
	103 x 115	P 180	10	6.25624
	103 x 115	P 240	10	6.25625
	103 x 115	P 320	10	6.25626
	103 x 115	P 400	10	6.25627

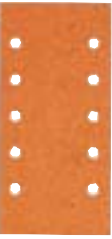
	Dimensions mm	Grit	Packing unit	Order no.
	Sanding sheets 115 x 140 mm, 6 holes, for clamping			
	115 x 140	P 40	10	6.25629
	115 x 140	P 60	10	6.25630
	115 x 140	P 80	10	6.25631
	115 x 140	P 100	10	6.25632
	115 x 140	P 120	10	6.25633
	115 x 140	P 180	10	6.25634
	115 x 140	P 240	10	6.25635
	115 x 140	P 320	10	6.25636
	115 x 140	P 400	10	6.25637
	Cling-fit sanding sheets 115 x 230 mm, 14 holes, with velcro			
	115 x 230	P 40	10	6.25786
	115 x 230	P 60	10	6.25787
	115 x 230	P 80	10	6.25788
	115 x 230	P 100	10	6.25789
	115 x 230	P 120	10	6.25790
	115 x 230	P 180	10	6.25791
	115 x 230	P 240	10	6.25792
	115 x 230	P 320	10	6.25793
	115 x 230	P 400	10	6.25794
	115 x 230	P 40	25	6.25796
	115 x 230	P 60	25	6.25797
	115 x 230	P 80	25	6.25798
	115 x 230	P 100	25	6.25799
	115 x 230	P 120	25	6.25800
	115 x 230	P 180	25	6.25801
	115 x 230	P 240	25	6.25802
	115 x 230	P 320	25	6.25803
	115 x 230	P 400	25	6.25804
		Sanding sheets 115 x 280 mm, 14 holes, for clamping		
115 x 280		P 40	10	6.24491
115 x 280		P 60	10	6.24492
115 x 280		P 80	10	6.24493
115 x 280		P 100	10	6.24494
115 x 280		P 120	10	6.24495
115 x 280		P 180	10	6.24496
115 x 280		P 240	10	6.24497
			Order no.	
10 cling-fit sanding sheets				6.25758
Assortment (2 each of P 40, P 80, P 120, P 180 and P 240)				
Dimensions: 80 x 133 mm				
Version: Perforated (8 holes)				
10 cling-fit sanding sheets				6.25774
Assortment (2 each of P 40, P 80, P 120, P 180 and P 240)				
Dimensions: 93 x 185 mm				
Version: Perforated (8 holes)				
10 sanding sheets				6.24490
Assortment (2 each of P 40, P 80, P 120, P 180 and P 240)				
Dimensions: 93 x 230 mm				
Version: Perforated (8 holes)				
10 sanding sheets				6.25628
Assortment (2 each of P 40, P 80, P 120, P 180 and P 240)				
Dimensions: 103 x 115 mm				
Version: Perforated (6 holes)				
10 sanding sheets				6.25638
Assortment (2 each of P 40, P 80, P 120, P 180 and P 240)				
Dimensions: 115 x 140 mm				
Version: Perforated (6 holes)				
10 cling-fit sanding sheets				6.25765
Assortment (2 each of P 40, P 80, P 120, P 180 and P 240)				
Dimensions: 115 x 230 mm				
Version: Perforated (14 holes)				
10 sanding sheets				6.24499
Assortment (2 each of P 40, P 80, P 120, P 180 and P 240)				
Dimensions: 115 x 280 mm				
Version: Perforated (14 holes)				

Sanding sheets for wood, "classic" series				
	Dimensions mm	Grit	Packing unit	Order no.
	Cling-fit sanding sheets 93 x 185 mm, 8 holes, with velcro			
	93 x 185	P 40	10	6.25813
	93 x 185	P 40	10	6.25814
	93 x 185	P 80	10	6.25815
	93 x 185	P 100	10	6.25816
	93 x 185	P 120	10	6.25817
	93 x 185	P 180	10	6.25818
	93 x 185	P 240	10	6.25819
	93 x 185	P 320	10	6.25820
	93 x 185	P 40	25	6.25822
	93 x 185	P 60	25	6.25823
	93 x 185	P 80	25	6.25824
	93 x 185	P 100	25	6.25825
	93 x 185	P 120	25	6.25826
	Sanding sheets 93 x 230 mm, non-perforated, for clamping			
	93 x 230	P 40	10	6.24808
	93 x 230	P 60	10	6.24809
	93 x 230	P 80	10	6.24810
	93 x 230	P 100	10	6.24811
	93 x 230	P 120	10	6.24812
	93 x 230	P 180	10	6.24813
	93 x 230	P 240	10	6.24814
	93 x 230	P 320	10	6.25808
		Sanding sheets 93 x 230 mm, 8 holes, for clamping		
93 x 230		P 40	10	6.24826
93 x 230		P 60	10	6.24827
93 x 230		P 80	10	6.24828
93 x 230		P 100	10	6.24829
93 x 230		P 120	10	6.24830
93 x 230		P 180	10	6.24831
93 x 230		P 240	10	6.24832
93 x 230		P 320	10	6.25807
		Cling-fit sanding sheets 115 x 115 mm, 8 holes, with velcro		
	115 x 115	P 40	5	6.24710
	115 x 115	P 60	5	6.24711
	115 x 115	P 80	5	6.24712
	115 x 115	P 100	5	6.24713
	115 x 115	P 120	5	6.24714
	115 x 115	P 240	5	6.24715
	Sanding sheets 115 x 140 mm, 8 holes, for clamping			
	115 x 140	P 40	10	6.24700
	115 x 140	P 60	10	6.24701
	115 x 140	P 80	10	6.24702
	115 x 140	P 100	10	6.24703
	115 x 140	P 120	10	6.24704
	115 x 140	P 240	10	6.24705

ANGLE GRINDERS
METAL PROCESSORS
HAMMERS
IMPACT DRILLS
DRILLS
SCREWDRIVERS
WOOD SANDING MACHINES
ROUTERS AND PLANERS

	Dimensions mm	Grit	Packing unit	Order no.
	Cling-fit sanding sheets 115 x 230 mm, 14 holes, with velcro			
	115 x 230	P 40	10	6.25832
	115 x 230	P 60	10	6.25833
	115 x 230	P 80	10	6.25834
	115 x 230	P 100	10	6.25835
	115 x 230	P 120	10	6.25836
	115 x 230	P 180	10	6.25837
	115 x 230	P 240	10	6.25838
	115 x 230	P 320	10	6.25839
	115 x 230	P 40	25	6.25841
	115 x 230	P 60	25	6.25842
	115 x 230	P 80	25	6.25843
	115 x 230	P 100	25	6.25844
	115 x 230	P 120	25	6.25845
	115 x 230	P 180	25	6.25846
	115 x 230	P 240	25	6.25847
	115 x 230	P 320	25	6.25848
		Sanding sheets 115 x 280 mm, non-perforated, for clamping		
115 x 280		P 40	10	6.24816
115 x 280		P 60	10	6.24817
115 x 280		P 80	10	6.24818
115 x 280		P 100	10	6.24819
115 x 280		P 120	10	6.24820
115 x 280		P 180	10	6.24821
115 x 280		P 240	10	6.24822
	Sanding sheets 115 x 280 mm, 14 holes, for clamping			
	115 x 280	P 40	10	6.24800
	115 x 280	P 60	10	6.24801
	115 x 280	P 80	10	6.24802
	115 x 280	P 100	10	6.24803
	115 x 280	P 120	10	6.24804
	115 x 280	P 180	10	6.24805
	115 x 280	P 240	10	6.24806
				Order no.
10 cling-fit sanding sheets				6.25821
Assortment (2 each of P 40, P 80, P 120, P 180 and P 240)				
Dimensions: 93 x 185 mm				
Version: Perforated (8 holes)				
10 sanding sheets				6.24833
Assortment (2 each of P 40, P 80, P 120, P 180 and P 240)				
Dimensions: 93 x 230 mm				
Version: Perforated (8 holes)				
Sanding sheet assortment				6.24815
Comprising 2 sanding sheets in each of the following grits: P 40, P 80, P 120, P 180, and P 240				
Dimensions: 93 x 230 mm				
Version: Not perforated				
10 cling-fit sanding sheets				6.25840
Comprising 2 sanding sheets in each of the following grits: P 40, P 80, P 120, P 180, and P 240				
Dimensions: 115 x 230 mm				
Version: Perforated (14 holes)				
10 sanding sheets				6.24807
Assortment (2 each of P 40, P 80, P 120, P 180 and P 240)				
Dimensions: 115 x 280 mm				
Version: Perforated (14 holes)				
10 sanding sheets				6.24823
Assortment (2 each of P 40, P 80, P 120, P 180 and P 240)				
Dimensions: 115 x 280 mm				
Version: Not perforated				

Sanding sheets for paints and lacquers, "professional" series				
	Dimensions mm	Grit	Packing unit	Order no.
	Cling-fit sanding sheets 80 x 133 mm, 8 holes, with velcro			
	80 x 133	P 40	25	6.25851
	80 x 133	P 60	25	6.25852
	80 x 133	P 80	25	6.25853
	80 x 133	P 100	25	6.25854
	80 x 133	P 120	25	6.25855
	80 x 133	P 180	25	6.25856
	80 x 133	P 240	25	6.25857
	80 x 133	P 320	25	6.25858
		Cling-fit sanding sheets 93 x 185 mm, 8 holes, with velcro		
93 x 185		P 40	25	6.25881
93 x 185		P 60	25	6.25882
93 x 185		P 80	25	6.25883
93 x 185		P 100	25	6.25884
93 x 185		P 120	25	6.25885
93 x 185		P 180	25	6.25886
93 x 185		P 240	25	6.25887
	Sanding sheets 93 x 230 mm, 8 holes, for clamping			
	93 x 230	P 40	25	6.25861
	93 x 230	P 60	25	6.25862
	93 x 230	P 80	25	6.25863
	93 x 230	P 100	25	6.25864
	93 x 230	P 120	25	6.25865
	93 x 230	P 180	25	6.25866
	93 x 230	P 240	25	6.25867
	Cling-fit sanding sheets 103 x 115 mm, 6 holes, with velcro			
	103 x 115	P 40	10	6.25639
	103 x 115	P 60	10	6.25640
	103 x 115	P 80	10	6.25641
	103 x 115	P 100	10	6.25642
	103 x 115	P 120	10	6.25643
	103 x 115	P 180	10	6.25644
	103 x 115	P 240	10	6.25645
	Sanding sheets 115 x 140 mm, 6 holes, for clamping			
	115 x 140	P 40	10	6.25648
	115 x 140	P 60	10	6.25649
	115 x 140	P 80	10	6.25650
	115 x 140	P 100	10	6.25651
	115 x 140	P 120	10	6.25652
	115 x 140	P 180	10	6.25653
	115 x 140	P 240	10	6.25654
115 x 140	P 320	10	6.25655	

Dimensions mm	Grit	Packing unit	Order no.
Cling-fit sanding sheets 115 x 230 mm, 14 holes, with velcro			
115 x 230	P 40	25	6.25891
115 x 230	P 60	25	6.25892
115 x 230	P 80	25	6.25893
115 x 230	P 100	25	6.25894
115 x 230	P 120	25	6.25895
115 x 230	P 180	25	6.25896
115 x 230	P 240	25	6.25897
115 x 230	P 320	25	6.25898
Sanding sheets 115 x 280 mm, 14 holes, for clamping			
115 x 280	P 40	25	6.25871
115 x 280	P 60	25	6.25872
115 x 280	P 80	25	6.25873
115 x 280	P 100	25	6.25874
115 x 280	P 120	25	6.25875
115 x 280	P 180	25	6.25876
115 x 280	P 240	25	6.25877
115 x 280	P 320	25	6.25878

	Order no.
10 cling-fit sanding sheets Assortment (2 each of P40, P80, P120, P180, P240) Dimensions: 103 x 115 mm Version: Perforated (6 holes)	6.25647
10 sanding sheets Assortment (2 each of P40, P80, P120, P180, P240) Dimensions: 115 x 140 mm Version: Perforated (6 holes)	6.25656





















Rolls for wood, "classic" series					
Dimensions mm	Grit	Packing unit	Order no.		
Rolls 93 mm x 5 m					
93 x 5	P 40	1	6.26003		
93 x 5	P 60	1	6.26004		
93 x 5	P 80	1	6.26005		
93 x 5	P 100	1	6.26006		
93 x 5	P 120	1	6.26007		
93 x 5	P 180	1	6.26008		
93 x 5	P 240	1	6.26009		
93 x 5	P 320	1	6.26010		
Rolls 115 mm x 5 m					
115 x 5	P 40	1	6.26013		
115 x 5	P 60	1	6.26014		
115 x 5	P 80	1	6.26015		
115 x 5	P 100	1	6.26016		
115 x 5	P 120	1	6.26017		
115 x 5	P 180	1	6.26018		
115 x 5	P 240	1	6.26019		
115 x 5	P 320	1	6.26020		







Single sheets				
Dimensions mm	Grit	Packing unit	Order no.	
Single sheet (230 x 280 mm) for wood, "classic" series				
230 x 280	P 40	50	6.26023	
230 x 280	P 60	50	6.26024	
230 x 280	P 80	50	6.26025	
230 x 280	P 100	50	6.26026	
230 x 280	P 120	50	6.26027	
230 x 280	P 180	50	6.26028	
230 x 280	P 240	50	6.26029	
230 x 280	P 320	50	6.26030	
Single sheets (230x280 mm) for paints and lacquers, "professional" series				
230 x 280	P 40	50	6.26033	
230 x 280	P 60	50	6.26034	
230 x 280	P 80	50	6.26035	
230 x 280	P 100	50	6.26036	
230 x 280	P 120	50	6.26037	
230 x 280	P 180	50	6.26038	
230 x 280	P 240	50	6.26039	
230 x 280	P 320	50	6.26040	
Single sheets (230 x 280 mm) for extremely hard materials, "expert" series				
230 x 280	P 80	50	6.26043	
230 x 280	P 100	50	6.26044	
230 x 280	P 120	50	6.26045	
230 x 280	P 180	50	6.26046	
230 x 280	P 240	50	6.26047	
230 x 280	P 320	50	6.26048	
230 x 280	P 400	50	6.26049	
230 x 280	P 600	50	6.26050	
230 x 280	P 1200	50	6.26051	



ANGLE GRINDERS
METAL PROCESSORS
HAMMERS
IMPACT DRILLS
DRILLS
SCREWDRIVERS
WOOD SANDING MACHINES
ROUTERS AND PLANERS

Which sanding medium for which machine and for which manufacturer?

SANDING BELTS FOR BELT-SANDERS		75 x 533 mm		100 x 610 mm					
60 x 400 mm			Bosch	PBS 60		Bosch	GBS 100A/AE		
				PBS 60E		Hitachi	SB10T/V		
63 x 406 mm			Skil	5903		Makita	9402		
				593U			9403		
65 x 410 mm			Metabo	BA 0665			9404		
				BAE 0666			9404		
			AEG	HBS 65			9924 DB		
				HBSE 65		Ryobi	B 7200 A		
			Black&Decker	BD 83/E			BE 424		
				BS 650		Wegoma	LB 31 EA		
				DN 83/E		100 x 620 mm			
				KA 83/E			Metabo	BA 6100	
			Holz Her	2405			AEG	HBS 10 /E	
				2406			Atlas Copco	BBS 100/E	
			Kress	CBS 6800 /E			Bosch	GBS 100A/AE	
							Hitachi	SB 110	
					Makita		9402		
							9924DB		
					102 x 552 mm				
							Peugeot	RP 102	
							Skil	1400 / H	
								1405 / H	
75 x 457 mm			Bosch	PBS 7	105 x 620 mm				
				Makita	9910		Metabo	BA 6100	
					9911		Festo	BS 105	
			Peugeot	PB 600				BS 105 E	
				TPB 7500				BS105 E-Set	
			Skil	1100	Hitachi		SB 110		
				1200 / H	Holz Her		2422		
				1205 / H			2423		
				7600 A			2424		
				7675 S	110 x 620 mm				
			Stayer	2 N 75			Casals	LC 110	
							Hitachi	SB 110	
							40 x 303 mm		
75 x 480 mm				Elu	MHB 157 / E			Bosch	GVS 350 AE
					MHB 158 / E				PVS 300 AE
75 x 508 mm			Black&Decker	BD 85	6/13 x 451 mm				
				DN 85/E		Black&Decker			
				KA 83		Powerfile	KA 290		
				SR 500 E			Powerfile	KA 292 E	
75 x 575 mm			Metabo	BAE 4350	100 x 533 mm				
						Makita	M 99		
75 x 610 mm			Hitachi	9924DB	100 x 560 mm				
				Makita	9920		AEG	BBS 1100	
					9924			BBSE 1100	
		Ryobi	B 7100				HBS 100 / E		
100 x 533 mm			Makita	M 99	Atlas Copco	BBS 100/E			
						De Walt	DW 650		
							DW 650 E		
						Elu	MHB 90/E/K		
						Festo	BU 25		
						Ryobi	B 422		
							BE 422 K 5		
							HB 422/E		
						100 x 610 mm			
						Bosch	GBS 100A/AE		
						Hitachi	SB10T/V		
						Makita	9402		
							9403		
							9404		
						9924 DB			
					Ryobi	B 7200 A			
						BE 424			
					Wegoma	LB 31 EA			

**SANDING BELTS
FOR BELT SANDERS**

Sanding belts for wood and metal, "professional" series				
	Dimensions mm	Grit	Packing unit	Order no.
	Sanding belts 65 x 410 mm			
	65 x 410	P 40	3	6.31410
	65 x 410	P 60	3	6.31411
	65 x 410	P 80	3	6.31412
	65 x 410	P 100	3	6.31413
	65 x 410	P 120	3	6.25901
	65 x 410	P 150	3	6.31414
	65 x 410	P 180	3	6.25902
	65 x 410	P 240	3	6.31415
		Sanding belts 75 x 457 mm		
75 x 457		P 40	3	6.25905
75 x 457		P 60	3	6.25906
75 x 457		P 80	3	6.25907
75 x 457		P 100	3	6.25908
75 x 457		P 120	3	6.25909
75 x 457		P 150	3	6.25910
75 x 457		P 180	3	6.25911
75 x 457		P 240	3	6.25912
		Sanding belts 75 x 480 mm		
	75 x 480	P 80	3	6.25916
	75 x 480	P 60	3	6.25917
	75 x 480	P 80	3	6.25918
	75 x 480	P 100	3	6.25919
	75 x 480	P 120	3	6.25920
	75 x 480	P 150	3	6.25921
	75 x 480	P 180	3	6.25922
	75 x 480	P 240	3	6.25923
		Sanding belts 75 x 533 mm		
75 x 533		P 40	3	6.31001
75 x 533		P 60	3	6.31002
75 x 533		P 80	3	6.31003
75 x 533		P 100	3	6.31004
75 x 533		P 120	3	6.31005
75 x 533		P 150	3	6.25927
75 x 533		P 180	3	6.31006
75 x 533		P 240	3	6.31007
75 x 533		P 320	3	6.31008
75 x 533		P 40	10	6.25929
75 x 533		P 60	10	6.25930
75 x 533		P 80	10	6.25931
75 x 533		P 100	10	6.25932
75 x 533		P 120	10	6.25933
75 x 533		P 150	10	6.25934
75 x 533		P 180	10	6.25935
75 x 533	P 240	10	6.25936	
75 x 533	P 320	10	6.25937	
	Sanding belts 75 x 575 mm			
	75 x 575	P 40	3	6.25940
	75 x 575	P 60	3	6.25941
	75 x 575	P 80	3	6.25942
	75 x 575	P 100	3	6.25943
	75 x 575	P 120	3	6.25944
	75 x 575	P 150	3	6.25945
	75 x 575	P 180	3	6.25946
	75 x 575	P 240	3	6.25947
		Sanding belts 75 x 610 mm		
75 x 610		P 40	3	6.25951
75 x 610		P 60	3	6.25952
75 x 610		P 80	3	6.25953
75 x 610		P 100	3	6.25954
75 x 610		P 120	3	6.25955
75 x 610		P 150	3	6.25956
75 x 610		P 180	3	6.25957
75 x 610		P 240	3	6.25958

	Dimensions mm	Grit	Packing unit	Order no.
	Sanding belts 100 x 560 mm			
	100 x 560	P 40	3	6.25962
	100 x 560	P 60	3	6.25963
	100 x 560	P 80	3	6.25964
	100 x 560	P 100	3	6.25965
	100 x 560	P 120	3	6.25966
	100 x 560	P 150	3	6.25967
	100 x 560	P 180	3	6.25968
	100 x 560	P 240	3	6.25969
	Sanding belts 100 x 610 mm			
	100 x 610	P 40	3	6.25973
	100 x 610	P 60	3	6.25974
	100 x 610	P 80	3	6.25975
	100 x 610	P 100	3	6.25976
	100 x 610	P 120	3	6.25977
	100 x 610	P 150	3	6.25978
	100 x 610	P 180	3	6.25979
	100 x 610	P 240	3	6.25980
	Sanding belts 100 x 620 mm			
	100 x 620	P 40	3	6.25984
	100 x 620	P 60	3	6.25985
	100 x 620	P 80	3	6.25986
	100 x 620	P 100	3	6.25987
	100 x 620	P 120	3	6.25988
	100 x 620	P 150	3	6.25989
	100 x 620	P 180	3	6.25990
	100 x 620	P 240	3	6.25991
	100 x 620	P 40	10	6.25993
100 x 620	P 60	10	6.25994	
100 x 620	P 80	10	6.25995	
100 x 620	P 100	10	6.25996	
100 x 620	P 120	10	6.25997	
100 x 620	P 150	10	6.25998	
100 x 620	P 180	10	6.25999	
100 x 620	P 240	10	6.26000	

	Order no.
3 sanding belts Assortment (1 each of P60, P80, P100) Dimensions: 65 x 410 mm	6.25903
3 sanding belts Assortment (1 each of P60, P80, P100) Dimensions: 75 x 457 mm	6.25913
3 sanding belts Assortment (1 each of P60, P80, P100) Dimensions: 75 x 480 mm	6.25924
3 sanding belts Assortment (1 each of P60, P80, P100) Dimensions: 75 x 533 mm	6.25928
3 sanding belts Assortment (1 each of P60, P80, P100) Dimensions: 75 x 575 mm	6.25948
3 sanding belts Assortment (1 each of P60, P80, P100) Dimensions: 75 x 610 mm	6.25959
3 sanding belts Assortment (1 each of P60, P80, P100) Dimensions: 100 x 560 mm	6.25970
3 sanding belts Assortment (1 each of P60, P80, P100) Dimensions: 100 x 610 mm	6.25981
3 sanding belts Assortment (1 each of P60, P80, P100) Dimensions: 100 x 620 mm	6.25992

ANGLE GRINDERS

METAL PROCESSORS

HAMMERS

IMPACT DRILLS

DRILLS

SCREWDRIVERS

WOOD SANDING MACHINES

ROUTERS AND PLANERS