

Neato All-Floor Robotic Vacuum User's Guide

READ ALL INSTRUCTIONS BEFORE USING THIS APPLIANCE.

SAVE THESE INSTRUCTIONS.

PLEASE REFER TO PAGE 10 FOR ADDITIONAL SAFETY INSTRUCTIONS.

neato robotics™

Neato Robotics, Inc.
8100 Jarvis Avenue Suite 100
Newark, CA 94560

p/n 500-0009 rev 4 - North America

Copyright © 2011 Neato Robotics, Inc. All rights reserved.

Neato Robotics and Your Future is Neat are registered trademarks of Neato Robotics, Inc.

Table of Contents

Welcome!	5
Anatomy of Your Neato Vacuum	6
Important Safety Instructions	10
Likes and Dislikes	11
Using the Neato Vacuum	15
Using the Charging Base	16
Charging Status	20
Optimal Charging	20
Cleaning Mode	21
Suspended Cleaning Mode	21
Quick-Start Your Robotic Vacuum	22
Using the Control Center LCD screen	24
Using Spot Mode for Cleaning Smaller Areas	26
Setting the Clock	28
Scheduling a Cleaning	30
To Get the Most of Scheduled Cleanings	32

Ideas for Scheduled Cleanings	33
Removing a Scheduled Cleaning	34
Changing the Language on the LCD Display	36
Pausing a Cleaning	37
Putting your Vacuum to Sleep.....	37
Turning off Your Vacuum	38
Emptying the Dirt Bin.....	39
Boundary Markers	41
Using boundary markers.....	41
Communicating with Your Neato Vacuum	42
Getting the Best Performance from Your Neato Vacuum	43
LCD Feedback Messages	44
Filters	47

Customer Support 48

One Year Limited Warranty - North America	49
Compliance Information	50
Declaration of Conformity	51
FCC COMPLIANCE STATEMENT.....	53
Disposal Notices	55
Neato Vacuum	55
Batteries	55
Linux Operating System	56

Welcome!

Thank you for purchasing your new Neato Vacuum. And welcome to the home robotics revolution.

This detailed user's guide will provide all you need to know. It's easy.

If you are in a hurry, and want to learn the basics to get started right away, you can read the Quick Start Guide. It's even easier.

We're here to help.

If you need help or have any questions, please contact our Customer Service team at <http://www.neatorobotics.com/support>.

We want to keep in touch.

To ensure that we keep you up to date on your new Neato Vacuum, please register at <http://www.neatorobotics.com/register>.

Neato is developing robotic home maintenance products that promise to free everyone from the drudgery of household cleaning.

Your Future is Neat®.

Anatomy of Your Neato Vacuum

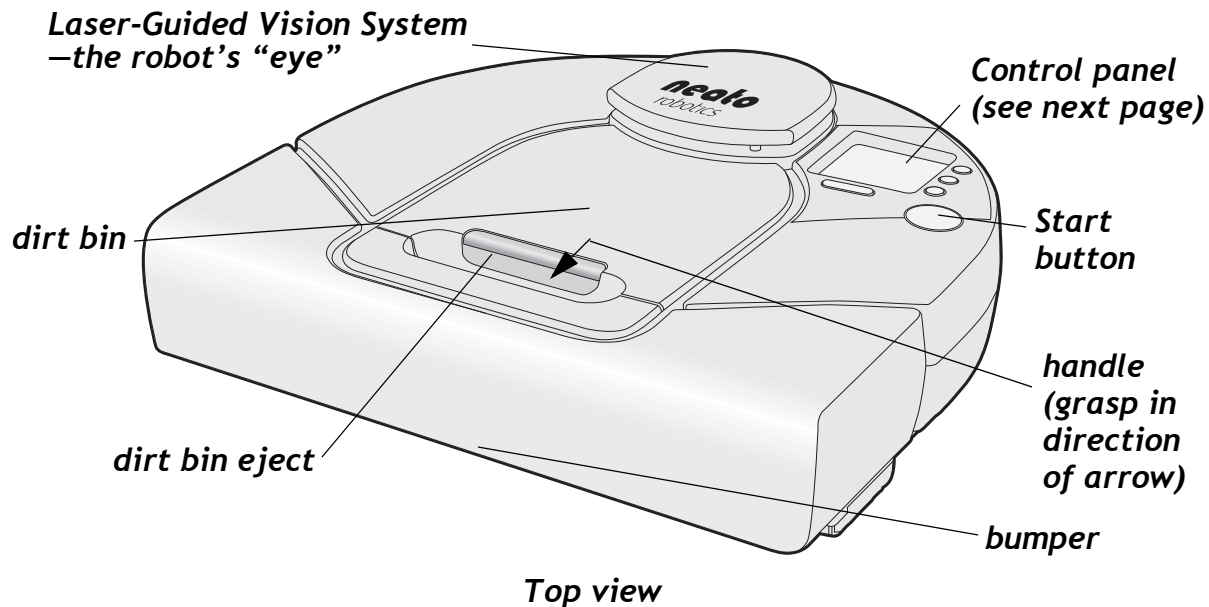

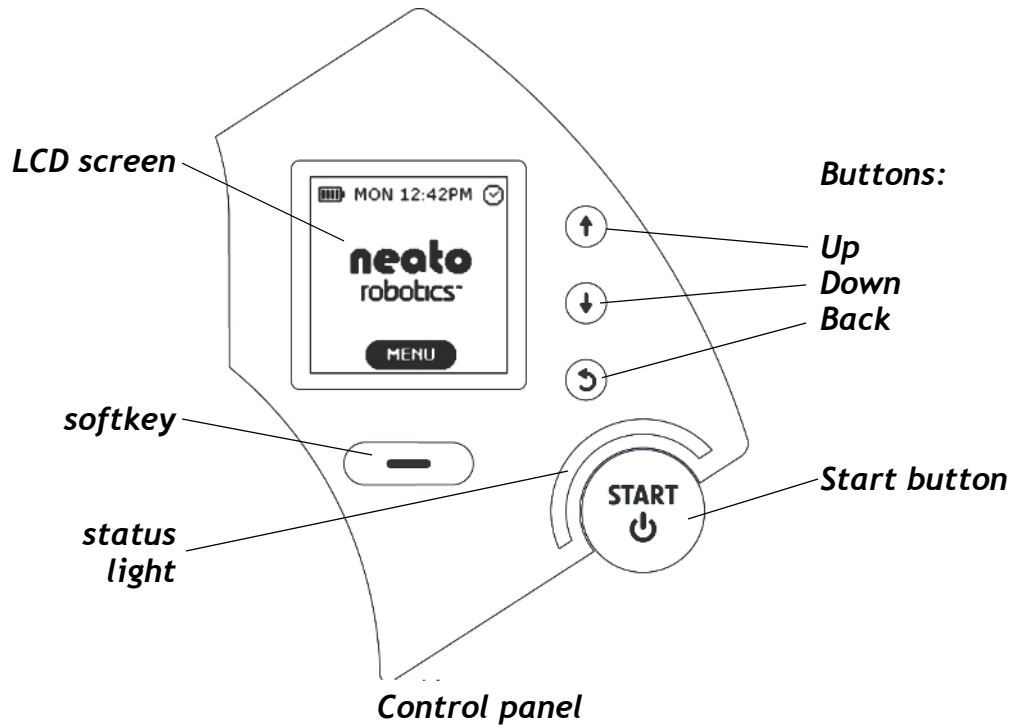

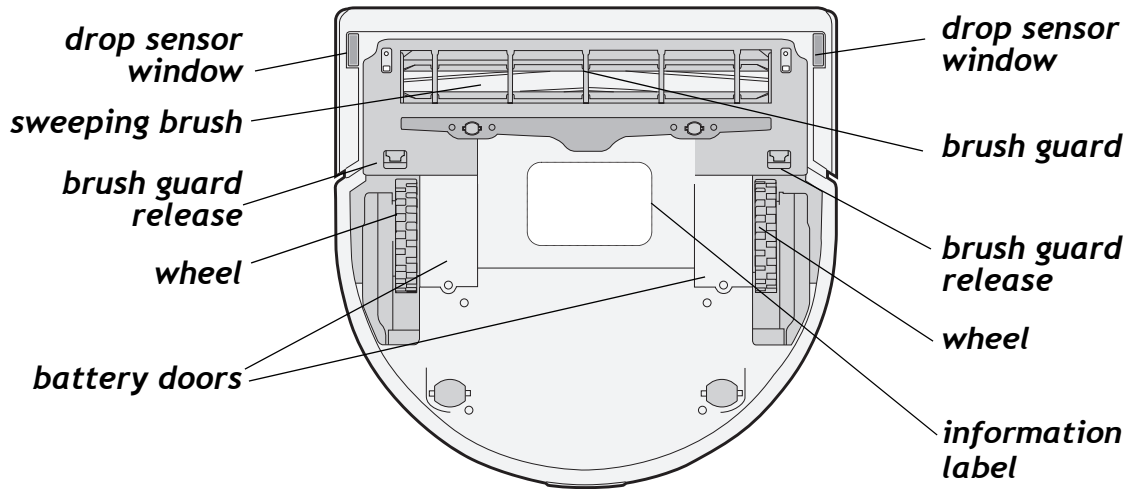

Bottom view

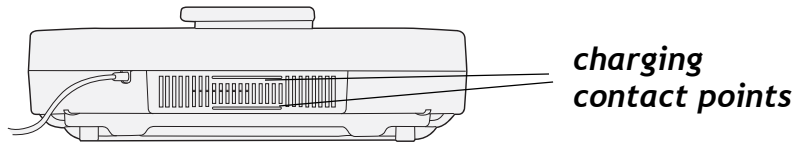

Back View

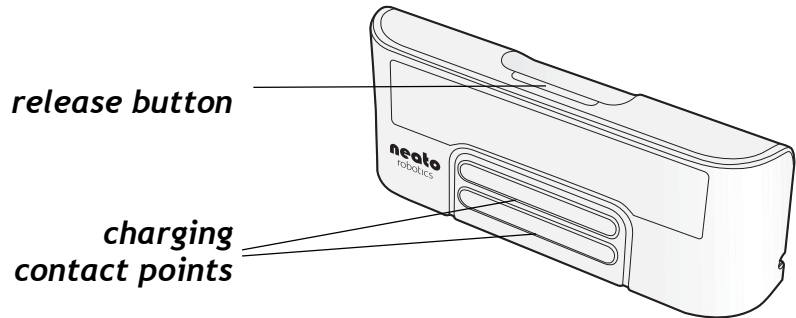

Charging base (external view)

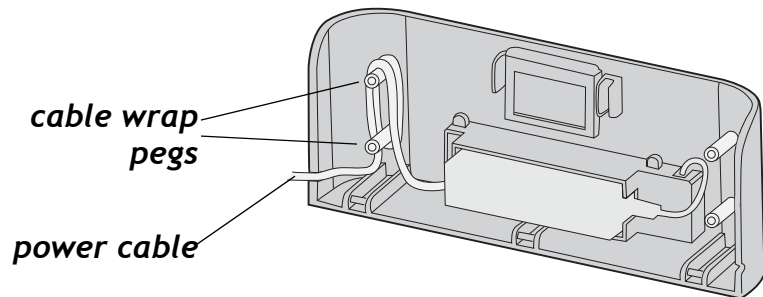

Charging base (internal view)

Important Safety Instructions

Please read all instructions before using this appliance.

Save these instructions for future reference.

Refer all non-routine servicing to Neato Robotics.

The robotic vacuum cleaner shall only be charged using the included power adapter or charging base.

The robotic vacuum cleaner shall only be operated using the included batteries. Do not replace with non-rechargeable batteries. If your batteries run low, replacement batteries can be purchased at <http://www.neatorobotics.com/support>.

This appliance is not intended for use by persons (including children) with reduced physical, sensory or mental capabilities, or lack of experience and knowledge, unless they have been given supervision or instruction concerning use of the appliance by a person responsible for their safety. Children should be supervised to ensure that they do not play with the appliance.

For best performance, empty your dirt bin and clean the vacuum's brush after each use.

Likes and Dislikes

There are just a few things to remember that will keep your Neato Vacuum happy and successful in your home:

Likes	Dislikes
<p>POWER. Charge it when you aren't using it to ensure that every time you need it, it will be ready to roll.</p>	<p>WATER, CHEMICALS, or OTHER MOLD PRODUCING FLUIDS. Do not clean wet messes with your Neato Vacuum. Though it may seem pet-like, do not bathe or otherwise submerge your Neato Vacuum in water. It also doesn't like harsh chemicals, or anything that can permanently stain it. It doesn't mind being cleaned and groomed with a damp cloth, however.</p>

Likes	Dislikes
<p>BOUNDARIES. Your Neato Vacuum likes to clean everywhere it can reach. If you want to keep the robot from a certain area, just put out the boundary markers (see page 41). The robot will clean up to the boundary markers but will not cross over the them.</p>	<p>HANGING CABLES AND LOW TO THE GROUND TABLECLOTHS. To keep your robot and your home safe, make sure that your vacuum cannot get caught on hanging electric cords, tablecloths, or other cord-like items.</p>
<p>GROOMING. Because it's down in the dirt all day long, your Neato Vacuum can get a little grungy. After a while, give it a once over to ensure wheels and brushes are free of hair and debris and to keep it running smoothly.</p>	<p>COLD. Exposing your Neato Robotics vacuum to freezing temperatures may cause permanent damage, and possibly hurt its feelings.</p> <p>OUTDOORS. Your Neato vacuum is a domestic device and not intended for outdoor use. Keep it in the house where it will be happy.</p>

Neato Vacuum cleaning smarts

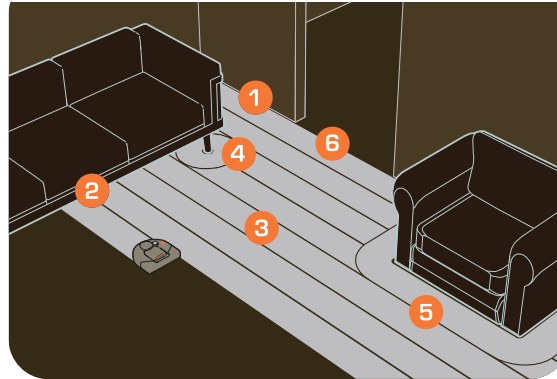

- 1- Rectangular front design allows vacuuming close to walls and into corners.***
- 2- Low profile allows cleaning under furniture.***
- 3- Always vacuums in straight lines.***
- 4 & 5- Cleans closely around obstacles.***
- 6- Automatic doorway recognition ensures complete cleaning of room before moving on to the next.***

(This page intentionally left blank.)

Using the Neato Vacuum

The Neato Vacuum is ready to start cleaning as soon as you charge up its battery.

- To charge the battery, see *Using the Charging Base* on page 16.
- To begin a quick-start cleaning, see *Quick-Start Your Robotic Vacuum* on page 22.
- To schedule regular cleanings, see *Scheduling a Cleaning* on page 30.

Using the Charging Base

Using the Charging Base

The Neato Vacuum has a preinstalled rechargeable battery that has to be fully charged before you can use it for the first time.

To use the charging base, follow these steps:

- 1 Plug the charging base into the wall and place it on the floor in a room that you want to vacuum frequently and which provides the vacuum a clear path to return to recharge itself.
- 2 When placing the charging base, ensure that:
 - the back of the charging base is against a wall
 - the charging base is least 3 feet from a corner of the room
 - the charging base is not tilted

NOTE: There are exit holes on either side of the charging base so that you can have the cable exit the charging base on the side closest to the wall plug. Refer to the illustration on page 9.

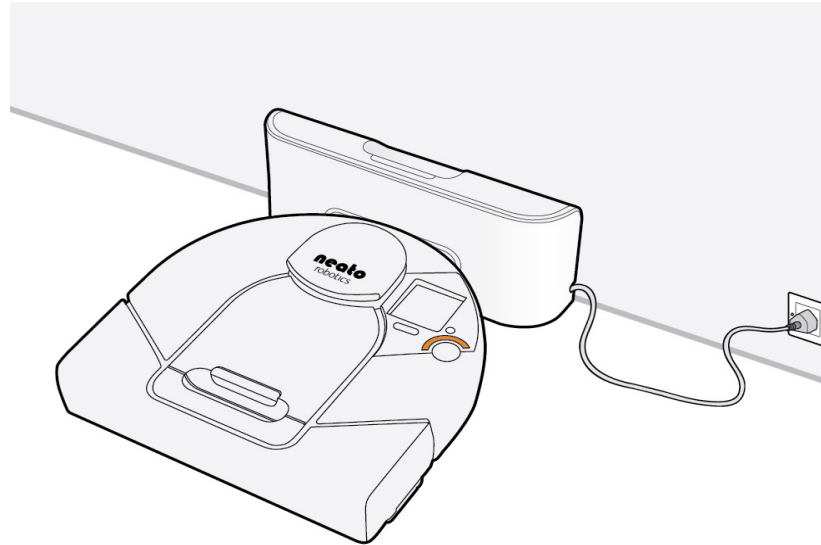

Connecting the Neato Vacuum to the charging base

Using the Charging Base

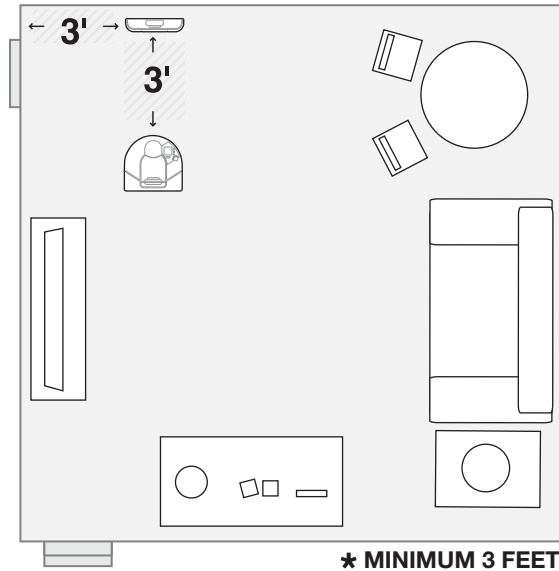

Giving the vacuum a clear path to its charger

- 3 Place the Neato Vacuum's curved edge up against the charging base so that the charging base's contact points make contact with the vacuum's charging contact points. The status light turns on to show you it is charging.

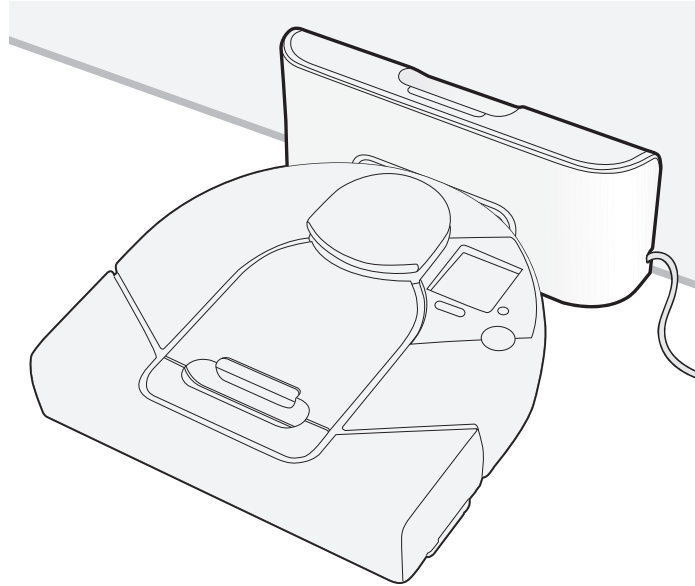

Neato Vacuum in its charging base

Charging Status

Charging Status

Recharging the battery takes about 2 to 3 hours. The status light lets you know the current charging state of your Neato Vacuum:

Status light color	Meaning
Solid green	Fully charged and ready to clean
Pulsing green	Charging, but ready to clean
Pulsing amber	Charging, can't clean yet
Solid amber	Vacuum has an error (see the LCD screen for details, and refer to <i>Communicating with Your Neato Vacuum</i> on page 42)

Optimal Charging

For optimal performance, we recommend that you charge your Neato Vacuum on the charging base whenever it is not cleaning. Not only will this make sure the vacuum will be ready for upcoming cleaning tasks, but it also ensures longer battery life.

Cleaning Mode

Your Neato Vacuum cleans using its powerful vacuum. Just press the START button and it will vacuum your floors, cleaning them one room at a time and then moving on to clean the next room. It will clean as many rooms as it can on one battery charge.

Suspended Cleaning Mode

In suspended cleaning mode, the Neato Vacuum cleans as much as it can on one battery charge, goes back to recharge, and returns to finish cleaning where it left off. While charging, it is in Suspended Cleaning mode. It keeps the room in its memory so that it can finish cleaning where it left off. Depending on how it was started, it will:

Started off of the Charging Base: If the Neato Vacuum was started off of its base and did not finish the cleaning job in one battery charge, it will return to base to recharge, and then start cleaning again where it left off. If it still hasn't finished the cleaning job, it will return to its charging base once more, recharge, and return to finish cleaning where it left off. The vacuum will clean for a maximum of 3 cleaning runs and then it will go back to its charging base to recharge.

Quick-Start Your Robotic Vacuum

Started Manually without Charging Base: If the Neato Vacuum was started manually off of its base and could not clean the space in one battery charge, it will go back to where it started and ask you to plug it in to recharge. It is in suspended cleaning mode while charging. When finished charging, place the Neato Vacuum within two feet of where it returned for charging, press START again, and it will return to where it left off to finish the cleaning job. It will repeat this one more time if it hasn't finished the cleaning job.

Quick-Start Your Robotic Vacuum

The Neato Vacuum works best when it performs regularly scheduled cleanings (see *Scheduling a Cleaning* on page 30), but you can quick-start the vacuum for immediate cleaning any time.

To start the Neato Vacuum:

- 1 Charge the vacuum (see *Using the Charging Base* on page 16). When the **START** button light is solid green, the vacuum is fully charged.
- 2 Remove any loose items (such as small toy pieces) that might get caught in the vacuum's brushes.

- 3 Place your Neato Vacuum on the floor.
- 4 Press the **START** button. If the vacuum is asleep, that will wake it up! Then press the button once more to clean your entire house.
- 5 The Neato Vacuum maps the room and cleans it automatically.
- 6 When finished, the vacuum returns to where it started—either to the charging base or to where you manually started it in the room and turns itself off.

Using the Control Center LCD screen

The Neato Vacuum's LCD Control Center screen is your interface to communicate with the vacuum. This is where you give the vacuum its cleaning schedule or pause its cleaning cycle, and it's also where the vacuum will give you information. For example, it may tell you that it is returning to its base to recharge. In addition, if your vacuum encounters a problem, it will tell you what is happening so you can correct the problem.

The Welcome screen looks like this:



The button (called a soft key) below the screen performs the action shown above it on the screen (in this case, **MENU**, which opens the main menu).

Using this screen, you can:

- Clean a smaller area using Spot mode (see page 26)
- Set the clock of the Neato Vacuum (see page 28)
- Program the Neato Vacuum to clean on a scheduled basis (see page 30)
- Get feedback from the vacuum on how it is doing and where it might need some help (see page 42)
- Change the language on the LCD display (see page 36)
- Pause the vacuum (see page 37)
- Turn off the lights on the vacuum (see page 37)
- Turn off power to the vacuum (see page 38)
- Cancel cleaning (see page 37)
- Return the Neato Vacuum to its charging base (see page 37)
- Get support information for Customer Service

Using Spot Mode for Cleaning Smaller Areas

Spot Mode will clean a small area approximately 4 feet by 6 feet.

To use Spot Mode:

- 1** Place the Neato Vacuum on the ground, centered, and facing the area to be cleaned, and press MENU.



- 2** Press the arrow buttons to select **Spot Clean** and then press **SELECT**.



- 3** The Neato Vacuum cleans the 4' by 6' area in front of it: first the outline of the area, and then the interior.

(This page left intentionally blank.)

Setting the Clock

Setting the Clock

Before you can schedule future cleanings, you must set the current day and time on the vacuum so it knows when to start the next cleaning.

To set the date and time:

- 1** Press **MENU**.



- 2** Press the arrow buttons to select **Set Clock** and then press **SELECT**.



- 3** Use the arrow buttons to select either **12-Hour Clock** or **24-Hour Clock** and then press **SELECT**.

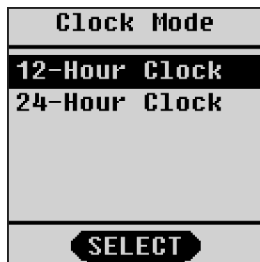

- 4** Use up and down arrows to select the current day of the week and press **ENTER**.

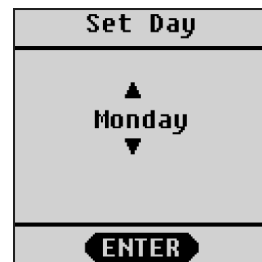

- 5** Use the arrow buttons to select the current hour and press **ENTER**. Cycle through the hours to select AM or PM.

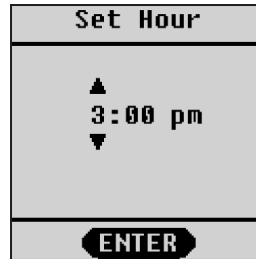

- 6** Use the arrow buttons to select the current minute and press **ENTER**.

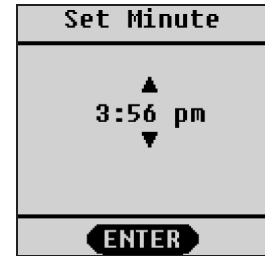

- 7** The current day and time are shown. Press the Back button  to make corrections; otherwise press **SAVE**.

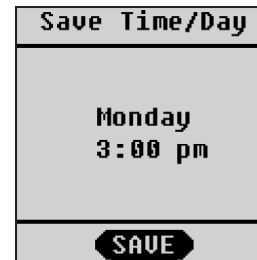

Scheduling a Cleaning

Scheduling a Cleaning

Before setting a schedule, set the clock as described in *Setting the Clock* on page 28.

To schedule a cleaning:

1 Press MENU.



2 Press the arrow buttons to select **Schedule** and then press **SELECT**.



3 Use the arrow buttons to select **Set or Change** and then press **SELECT**.

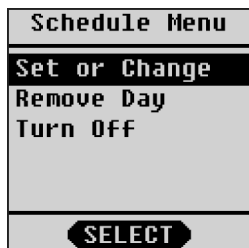

4 Use the arrow buttons to select the day you want your vacuum to clean and press **SELECT**.

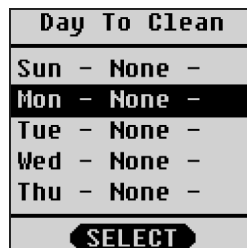

- 5** Use the arrow buttons to select the hour you want your vacuum to clean and then press **SELECT**.

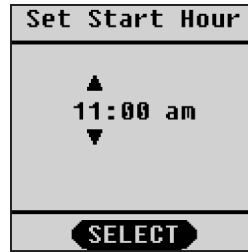

- 6** Use the arrow buttons to select the minute you want your vacuum to clean and then press **SELECT**.

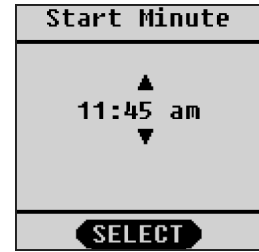

- 7** Confirm the day, time, and cleaning mode by pressing **ADD**. To make changes, press the Back button ⏪.

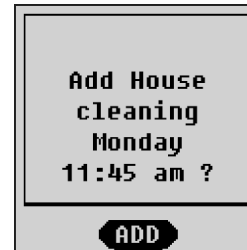

Future cleanings will occur at the times and dates you selected. At each scheduled time, the Neato Vacuum will come off of the charging base and start its scheduled cleaning. When finished cleaning, the vacuum returns to the charging base to recharge. If the battery runs low during the scheduled cleaning, the vacuum returns to its base, recharges, then returns one more time to clean where it left off.

To Get the Most of Scheduled Cleanings

If you are not using the charging base, you will need to put the Neato Vacuum out and it will start its scheduled cleaning when that is the actual time and day of the week. When you return, you will need to manually place the vacuum on its charging base or plug the charger directly into the vacuum.

To Get the Most of Scheduled Cleanings

- The charging base needs to be located within the area that you want to clean on a schedule.
- Make sure you empty the dirt bin (see *Emptying the Dirt Bin* on page 39) between scheduled cleanings for best results.
- If there is not enough battery power to complete the cleaning cycle, your Neato Vacuum returns to the charging base to recharge, and then will return to where it left off to finish its cleaning.

Ideas for Scheduled Cleanings

Some ways you can take advantage of scheduled cleanings include:

- Clean a specific high-traffic area on a regular basis. For example, you could set up a schedule to clean your kitchen and family room everyday at 10 a.m. Locating your charging base in the kitchen, the Neato Vacuum comes off its charging base, cleans the rooms, and returns to the charging base. Cleaning on an everyday basis helps to minimize dust build up and can result in a reduction in allergy symptoms.
- You could also have your charging base in your bedroom corridor and schedule it to clean every other day to keep your bedroom floors tidy. To keep the robot in that area of the house, just put out the Boundary Markers and then it will go out and clean as much as it can, return to charge, and then go back out to finish the cleaning where it left off if the area is large.

Removing a Scheduled Cleaning

If you need to remove a previously-scheduled cleaning, follow these steps.

1 Press MENU.



2 Press the arrow buttons to select Schedule and then press SELECT.



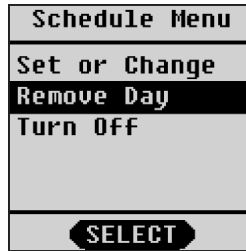

Removing a Scheduled Cleaning

- 3** Use the arrow buttons to select **Remove Day** and then press **SELECT**.

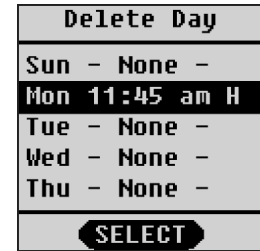

- 4** Use the arrow buttons to choose the cleaning event you want to remove and then press **SELECT**.



- 5** Press **DELETE** to confirm deletion. Use the Back button  if you made a mistake.

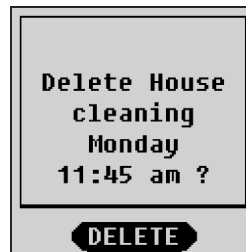

- 6** A confirmation message verifies the scheduled cleaning that you removed.

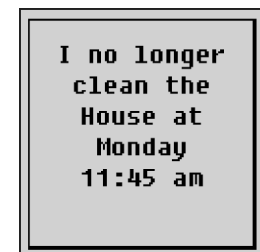

Changing the Language on the LCD Display

If you want to use a different language on the LCD display, follow these steps:

1 Press MENU.



2 Press the arrow buttons to select **Language** and then press **SELECT**.



3 Use the arrow buttons to select the language you want to use then press **SELECT**.



4 The LCD will now use the language you selected.

Pausing a Cleaning

If at any time you want to pause a cleaning, press any button on the Neato Vacuum and the vacuum will offer you a PAUSE menu. From the PAUSE menu, press the down arrows to make the vacuum:

- Pause its current cleaning
- Cancel its current cleaning
- Cancel and return to its charging base
- Resume its current cleaning

Use the up and down arrows and the SELECT button to tell your Neato Vacuum to do any of the above items.

Putting your Vacuum to Sleep

Press and hold the START button for 2 seconds and your Neato Vacuum's LCD screen light will go off. When the vacuum is turned on the next time, the lights will turn on again.

Turning off Your Vacuum

If you would like to turn off your vacuum for long term storage or if you are going away for vacation, you can turn off all power to your Neato Vacuum. Note that this will delete your clock settings.

To turn off your vacuum:

- 1 Select MENU from the LCD screen.
- 2 Select SUPPORT.
- 3 Select Shut Down.

To power your vacuum once you have done this, just press the START button and it will be fully powered again.

NOTE:Your Neato Vacuum cannot be on its charging base when you turn off all power to it.

NOTE:The robot will turn itself off automatically if the battery is extremely low. If your clock has been reset and the schedule is no longer available, it is because the battery became fully discharged. This is why we recommend that you keep the robot charging at all times when not in use for cleaning.

Emptying the Dirt Bin

For optimal performance, empty the Neato Vacuum's dirt bin after every use.

- 1 Remove the dirt bin.

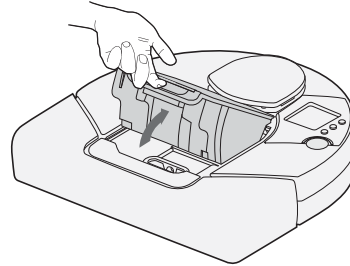

- 2 Remove the filter.

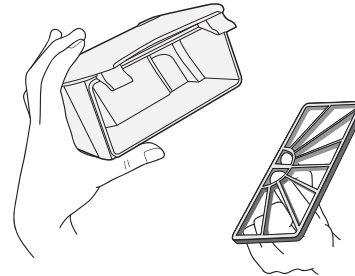

Emptying the Dirt Bin

- 3** Empty the contents of the dirt bin into a garbage can. Tap the filter against the garbage can to get rid of any excess dirt.

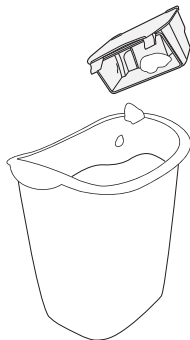

- 4** Replace the filter cover, then replace the dirt bin into the top of the Neato Vacuum.

Boundary Markers

Boundary Markers are useful tools that tell your Neato Vacuum where *not* to clean.

Boundary markers are most helpful when you want to:

- Create a boundary where one does not exist. You might have a large open plan house where you want to clean a subset of a large room like the shaded area shown here.
- Keep your Neato Vacuum away from any item that you don't want the vacuum to get near.

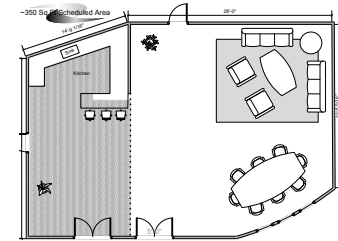

Using boundary markers

To use the markers, simply lay the boundary marker flat on the floor from one wall to the opposite wall to block off an area. The Neato Vacuum will clean the floor on the side of the boundary marker that it is started on. Place the vacuum within the bounded area and press START. The vacuum recognizes the boundary markers and will not cross them. You can use scissors to cut a shorter length of the boundary markers if needed.

When finished, the vacuum returns to its charging base or to where it started if it cannot find its base. (In this case, you need to start charging the vacuum as soon as you can.)

Communicating with Your Neato Vacuum

Communication is a two-way street, so be sure to listen when your Neato Vacuum is talking to you!

When it's charging, the status light around the START button will be GREEN to indicate your Neato Vacuum is ready for work.

If the status light is AMBER, the Neato Vacuum needs some assistance before going to work. Just read the LCD control center screen to see what your vacuum needs assistance with. The vacuum will tell you when to:

- Empty its dirt bin and filter
- Fix its stuck brush
- Unstick its bumper
- Clean its drop sensor windows

...and other feedback too.

Getting the Best Performance from Your Neato Vacuum

- 1 Empty your Dirt Bin after every cleaning
- 2 Clean your brush of debris frequently
- 3 Periodically dust off your drop sensors. Using a cotton swab, clean the two drop sensor windows on the bottom of your Neato Vacuum, located as shown below.

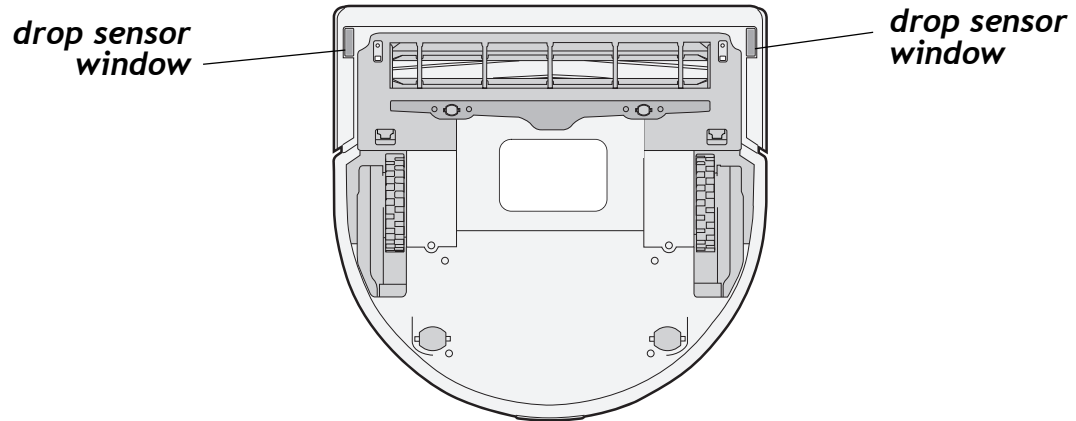

Cleaning the drop sensors

LCD Feedback Messages

Your vacuum is smart and will let you know when it needs help with anything. Just read the messages on the LCD to understand what it needs. Here are some specific tips.

LCD Message	Remedy
Dirt Bin Full	Empty dirt bin and replace into its slot.
Brush Stuck	Remove brush guard and clean all hair and debris from brush and brush shaft. Replace brush and guard and press START button to resume cleaning.
Bumper Stuck	Jiggle the bumper to loosen.
Time Not Set	If your battery runs very low, the Neato Vacuum loses its clock setting. Use the menus to reset the time and day as described in <i>Setting the Clock</i> on page 28.

LCD Message	Remedy
Cannot Charge	Make sure the charging cable is plugged into the base and wall. When vacuum is initially connected to the base, the status light will light up to let you know the power is on.

LCD Feedback Messages

LCD Message	Remedy
Vacuum Won't Dock	<p>If your vacuum is having difficulty docking on its charging base, ensure that:</p> <ul style="list-style-type: none">• the charging base is located at least 3 feet from a corner of a room• the charging base has clearance 3 feet in front of it• the charging base is not hidden behind a couch or other furniture• the charging base is solid against a wall and is not leaning backward or forward• if charging base is on carpet, try relocating to a hard floor surface <p>If you still have difficulties, please contact Neato Customer Care.</p>

Filters

To get the best results, we recommend emptying your dirt bin and cleaning the filter after every vacuum session as described in *Emptying the Dirt Bin* on page 39. To clean your filter, just tap the filter against a garbage can to loosen the debris off of it.

We also recommend changing your filter in your vacuum every three to six months (based on typical usage; if you use your vacuum more frequently, you may need to change your filter more often.)

You can purchase additional filters online at <http://www.neatorobotics.com>.

Customer Support

If you have any questions or comments, contact Neato Robotics, Inc.

- **Email** customer@neatorobotics.com
- **Visit** www.NeatoRobotics.com for additional support, accessories, and frequently asked questions.
- **Call** a customer care specialist:
 - **United States:** 1-877-29-NEATO

One Year Limited Warranty - North America

Neato Robotics, Inc. warrants to the original purchaser ("you" or "your") that your Neato Robotics hardware product shall be free from defects in material and workmanship for 365 days from the date of purchase from Neato Robotics or its authorized reseller. You may also find this information by selecting your product in the Support section of our website at www.neatorobotics.com. Except where prohibited by applicable law, this warranty is nontransferable, is limited to the original purchaser, and applies only to products purchased and used in North America. This warranty gives you specific legal rights, and you may also have other rights that vary under local laws.

Compliance Information

Room Positioning System: RPS Infrared Laser Distance Sensor

This Laser Product is designated as Class 1 during all procedures of operation.

Human Accessible Laser Parameters:

- Wavelength 785 nm
- Pulse Rep Frequency 1.8 kHz
- Pulse Duration 200 μ sec
- Peak Power 2.1 mW
- Beam Diameter 2.3 mm
- Beam Divergence -1.5 mrad

Caution: Use of controls or adjustments or performance of procedures other than those specified herein may result in hazardous radiation exposure.

Neato Robotics, Inc.
8100 Jarvis Avenue Suite 100
Newark, CA 94560

No service is allowed by the user. If there are any problems with the RPS laser distance sensor, the robot should be returned to the factory for any service or repair.

Declaration of Conformity

We declare under our sole responsibility that the,

Robotic Vacuum Cleaner

Model: XV Series and derivatives

to which this declaration relates, is in conformity with the following standards,

Council Directive 2006/95/EC – Low Voltage Directive

EN60335-1: 2002 + A1+ A2 +A11 +A12 +A13

IEC/ EN 60335-2-2:2003 + A1 + A2

EN 50366:2003 + A1

The last two digits of the year in which the CE marking was affixed are 10.

Council Directive 2004/108/EC – Electro Magnetic Compatibility Directive

EN55014-1:1997 w/ A1: 2001, and A2:2001, Class B,

EN 55014-2:1997

EN 61000-3-2: 2006 (AC Charger)

EN 61000-3-3: 2008 (AC Charger)

All technical documentation required to demonstrate that the products meet the requirement of the Low Voltage Equipment Directive has been compiled and is available for inspection by the relevant enforcement authorities. Details of these special measures and limitations to use are available upon request. The CE mark was first applied in 2010 and re-issued in 2012 due to new product variants.

April 2012

Date of Issue
Neato Robotics
Newark, CA
USA



FCC COMPLIANCE STATEMENT

This device complies with part 15 of the FCC rules. Operation is subject to the following two conditions:

- 1 this device may not cause harmful interference, and
- 2 this device must accept any interference received, including interference that may cause undesired operation

NOTE: This equipment has been tested and found to comply with the limits for a Class B digital device, pursuant to part 15 of the FCC Rules. These limits are designed to provide reasonable protection against harmful interference in a residential installation. This equipment generates, uses and can radiate radio frequency energy and, if not installed and used in accordance with the instructions, may cause harmful interference to radio communications. However, there is no guarantee that interference will not occur in a particular installation. If this equipment does cause harmful interference to radio or television reception, which can be determined by turning the equipment off and on, the user is encouraged to try to correct the interference by one or more of the following measures:

- Reorient or relocate the receiving antenna.
- Increase the separation between the equipment and receiver.
- Connect the equipment into an outlet on a circuit different from that to which the receiver is connected.
- Consult the dealer or an experienced radio/TV technician for help.



Trade Name: NEATO

Model Number: XV Series

Responsible Party: NEATO Robotics

Changes or modifications not expressly approved by Neato can void the user's authority to operate the equipment.

Disposal Notices

Neato Vacuum

If you ever dispose of your Neato Vacuum, follow these steps:

- 1 Unplug the Neato Vacuum from any power source, including removing it from its charging base and removing the power adapter plug from the Neato Vacuum power connector.
- 2 Unscrew the battery doors (shown in the bottom view illustration on page 8) and unplug and remove the batteries.
- 3 Take the vacuum to the nearest waste management electronics recycling center.
- 4 Take the batteries to a battery recycling program at your school, place of work, or your nearest waste management battery recycling center.

Batteries

If the batteries leak due to overheating or physical abuse, place them in a plastic bag and dispose of them in accordance with all applicable federal, state, and local regulations. Following battery removal, the battery compartments in the Neato Vacuum should be wiped with a damp cloth and allowed to dry before installing new batteries.

Linux Operating System

Some Neato products incorporate and rely upon the Linux operating system. Linux is licensed to the public under version 2 of the [GNU General Public License](http://www.gnu.org/licenses/gpl-2.0.html) (“GPLv2”), a copy of which is available at <http://www.gnu.org/licenses/gpl-2.0.html>. Neato has made modifications to Linux to improve the operating system’s functionality on Neato products. The source code for the Linux operating system, including Neato’s modifications, is available for download at <http://www.neatorobotics.com/lab/linux>.

Notwithstanding anything to the contrary in the Neato EULA, Linux installations included with Neato products and available for download from the Neato website are governed by the terms of the GPLv2. To the extent that any of the terms and conditions of the Neato EULA conflict with the GPLv2, such conflicting terms of the Neato EULA do not apply to the Linux installations. The licensors of the Linux operating system disclaim all warranties and liability, whether express or implied, relating to or resulting from use or distribution of the Linux operating system. Please consult the GPLv2 for additional licensing information relating to Linux.

NOTE: The Neato application, which provides functionality specific to the Neato products, such as the LCD menu and the robot’s navigation intelligence, is proprietary software developed by Neato Robotics, Inc. The Neato application has not been combined or distributed with the Linux operating system in a manner that would obligate Neato to license the application under the terms of

the GPLv2. Use of the Neato application is governed by the applicable Neato EULA (<http://www.neatorobotics.com/EULA>). For clarity, Neato has not placed the Neato application in the public domain, nor has Neato licensed the application under the terms GPLv2.

NOTE: If you are unable or unwilling to download our modifications from <http://www.neatorobotics.com/lab/linux>, you may instead request to receive a CD-R with our modifications. To do so, please send a written request to:

Neato Robotics, Inc.
Attention: Customer Care - GNU/Linux Source Code Request.
8100 Jarvis Ave. Suite 100
Newark, CA 94560

Please include a check in the amount of \$15.00 to cover reproduction, shipping, and handling costs. Please allow 3 weeks for shipping once we receive your request.