

# **ZOOMAX<sup>®</sup> AURORA HD**

## **Desktop Video Magnifier**



## **User's Guide**

**Version 3.0**

**ZOOMAX Technology Co., Limited**

ZOOMAX Technology Co., Limited

C-402, Hangzhou Digital Information Industrial Park, No.11

Xiyuan 8 Road, Xihu District, Hangzhou, China. 310030

Copyright© 2013 ZOOMAX Technology Co., Limited. All Rights Reserved. ZOOMAX® is a trademark of ZOOMAX Technology Co., Limited in the United States and other countries. Information in this document is subject to change without notice. No part of this publication may be reproduced or transmitted in any forms or by any means electronic or mechanical, for any purpose, without the express written permission of ZOOMAX.

To contact by e-mail, send questions to [sales@zoomax.co](mailto:sales@zoomax.co).

To search the knowledge base, visit [www.zoomax.co](http://www.zoomax.co) and choose the relative links.

# Table of Contents

1. Structure Components .....	3
2. Package .....	4
3. Setup .....	5
4. XY Table .....	7
5. Basic Operation.....	8
Power on/off .....	8
Magnification/ Auto Zoom (AZ).....	9
Color Mode .....	10
Brightness Adjustment.....	10
Find Function.....	11
Demo .....	11
6. Advanced Operation.....	11
Electronic Curtain .....	12
Focus Lock .....	13
Freeze Function/ Reset Factory Default Setting .....	14
Turn off the LED Light .....	15
Advanced Color Mode .....	15
Demo Mode .....	16
7. Specifications .....	16
8. Important Safety Instructions .....	17
9. Other products from ZOOMAX .....	19

# 1. Structure Components

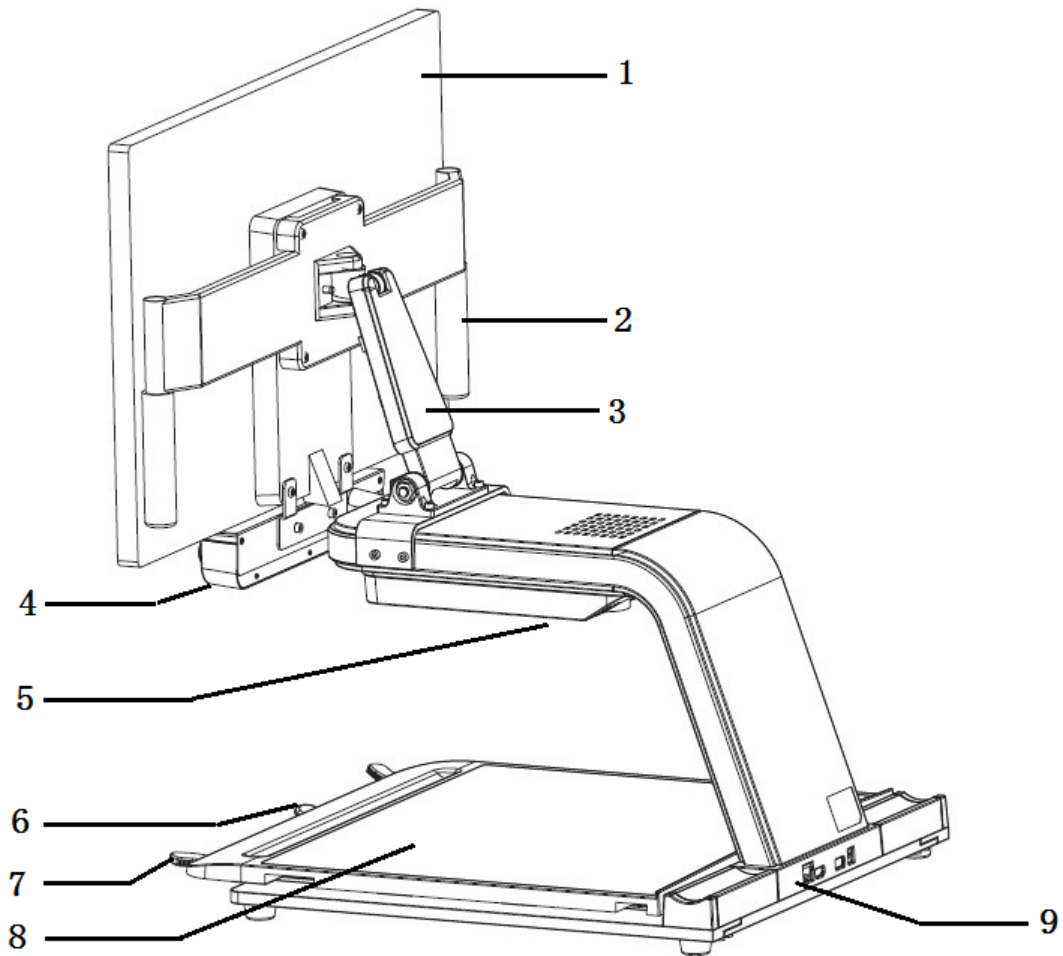

1. Monitor

2. Support Handle

3. Support Stand

4. Control Panel

5. LED Light

6. Brake

7. Tactile Handle

8. XY Table

9. Ports from Left to Right:

①KB: for Control Panel when connected to External Monitor

②HDMI: for Video Input when connected to External Monitor

③USB: for FW Update

④DC IN: for Power Input

## 2. Package



Figure 2

- In full package, the monitor screen is folded backwards on the Support Stand.

### 3. Setup



**Figure 3**

- After moving the unit out of the packing carton, hold on both sides of the monitor to pull up the monitor.



- Plug-and-play. Plug in the power and the monitor will be on automatically.

## Notes:



- Monitor Height : Adjustable.



- Display Orientation: Rotate to left and right (Max: 45°).

## 4. XY Table

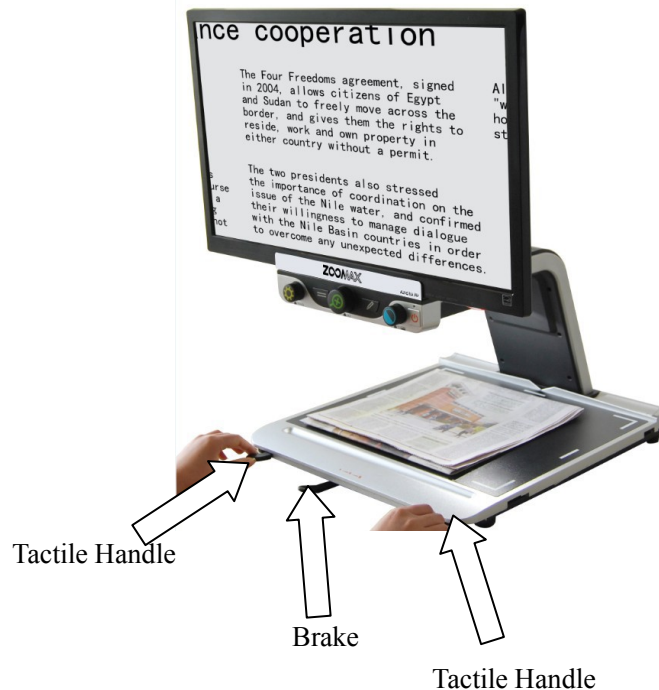

- Turn the Brake (the button in the middle of **XY Table**) to the right side to lock the **XY Table** if you need long time reading.
- Turn the Brake to the middle position to lock the Y axis, and then you can only move the **XY table** to left and right. Turn the Brake to the left side to unlock the **XY Table**. Then, you can shift the **XY Table** as you need.
- Please use the tactile handle to save your energy and help you comfortably move **XY Table**.



## 5. Basic Operation

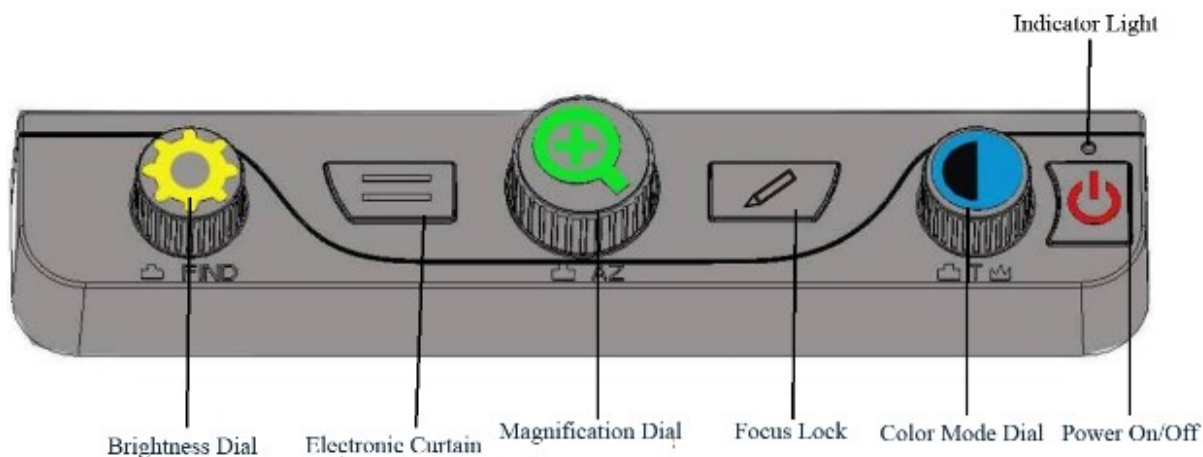

- In factory default, you are in Basic Operation.

### Power on/off

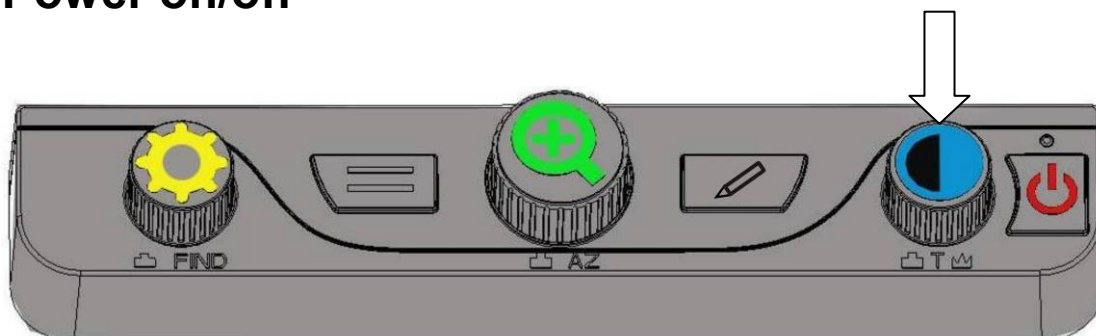

- Follow the arrow direction to short press the **Power On/Off** Button to turn on Aurora HD.
- Keep pressing the **Power On/Off** Button for 3 seconds to turn off Aurora HD.

### Note:

- You hear “beep” and the Indicator Light turns green shortly after you press the **Power On/Off** Button.

- If the LCD screen remains blank after you hear “beep”, please make sure the monitor cable is connected well and the monitor is turned on.

## Magnification/ Auto Zoom (AZ)

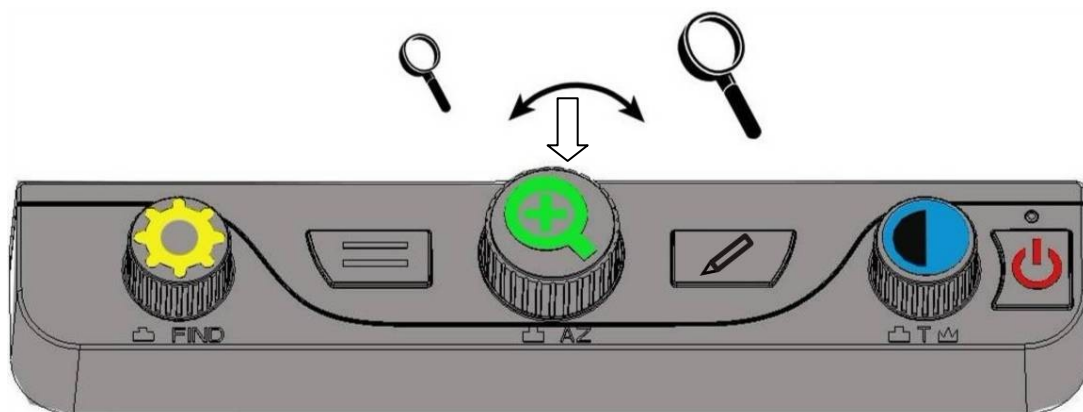

- Turn the **Magnification Dial** Button to adjust magnification. The magnification range is from 2X to 70X.
- Turn the **Magnification Dial** Button to get your preferred magnification. Keep pressing the **Magnification Dial** Button until you hear “beep” to save this preferred magnification. Whatever magnification view you are in, if you short press the **Magnification Dial** Button, it will return to your preferred magnification immediately.

## Color Mode

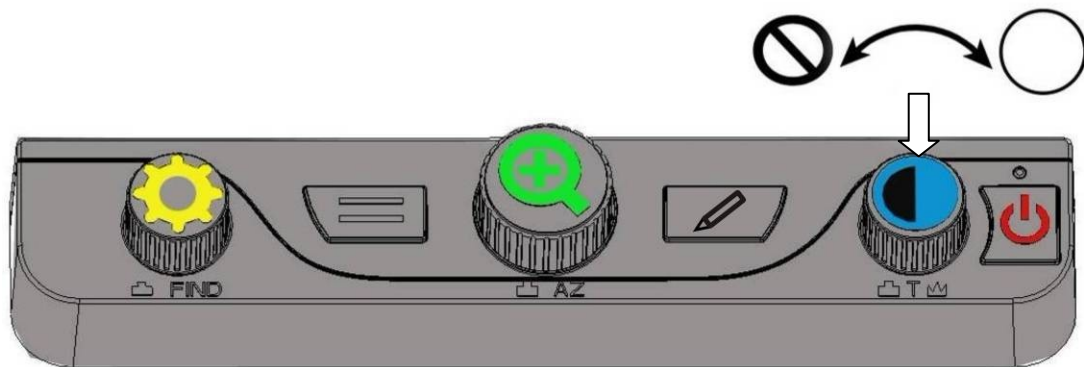

- Turn the **Color Mode Dial** Button to choose a color mode that best suits your vision needs. There are 5 color modes for your options (Full Color, Black on White, White on Black, Yellow on Blue and Yellow on Black).
- Short press the **Color Mode Dial** Button to switch between full color and your favorite high contrast color.

## Brightness Adjustment

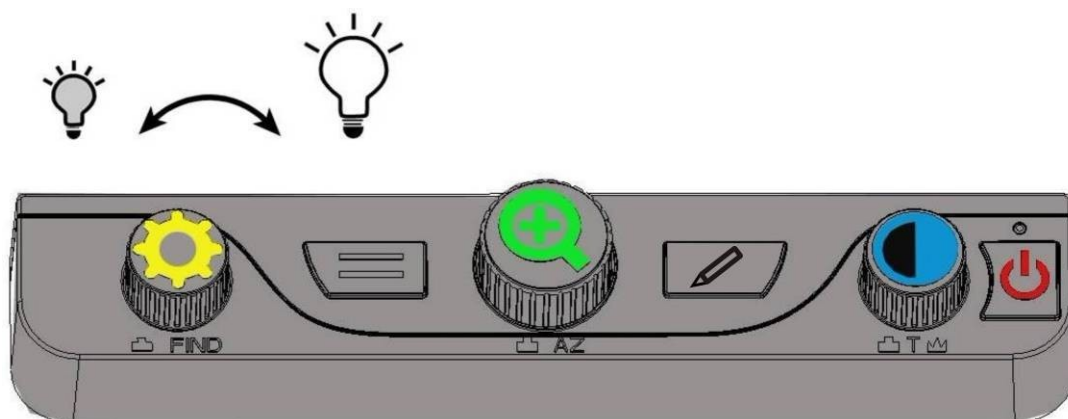

- Turn the **Brightness Dial** Button to adjust brightness you prefer. The default value is 50.

## Find Function

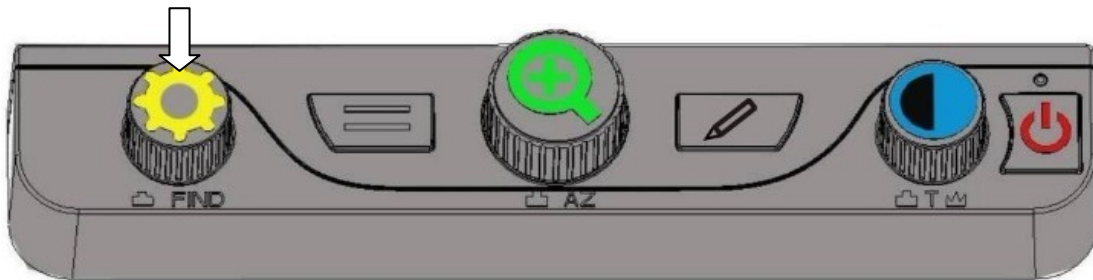

- Keep pressing and hold the **Brightness Dial** Button to zoom out, you will see a square frame appears on the LCD screen. Move the XY Table to make the Square Frame being centered on the reading material you need. Then, release the **Brightness Dial Button** to zoom in. The Square Frame disappears. You can view the part of the reading material you need easily now.

## Demo

- In Full Color mode, long press Electronic Curtain Button to start Demo function.

## 6. Advanced Operation

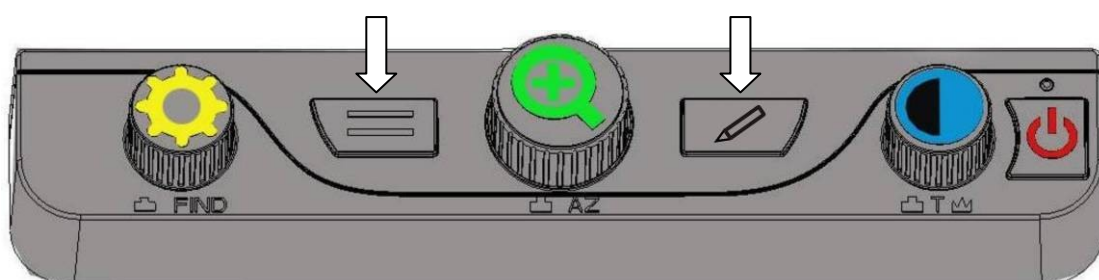

- Keep pressing the **Electronic Curtain** Button and

**Focus Lock** Button simultaneously until you hear “beep” to enter into Advanced Operation.

- Keep pressing the **Electronic Curtain Button** and **Focus Lock** Button simultaneously again until you hear “beep” to exist from Advanced Operation and go back to Basic Operation.

## Electronic Curtain

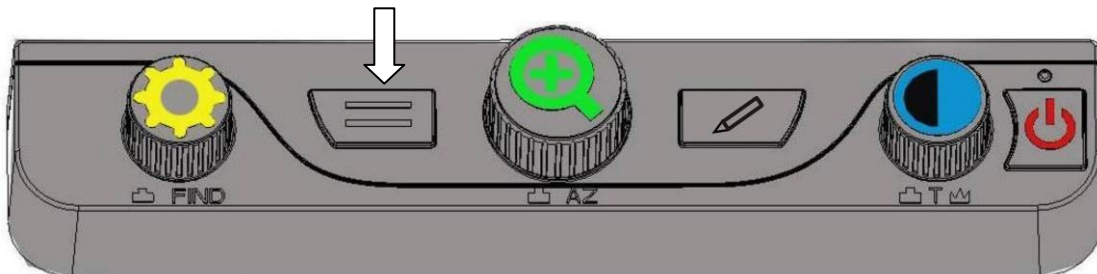

- Press the **Electronic Curtain** Button to shift among 6 electronic curtain modes.

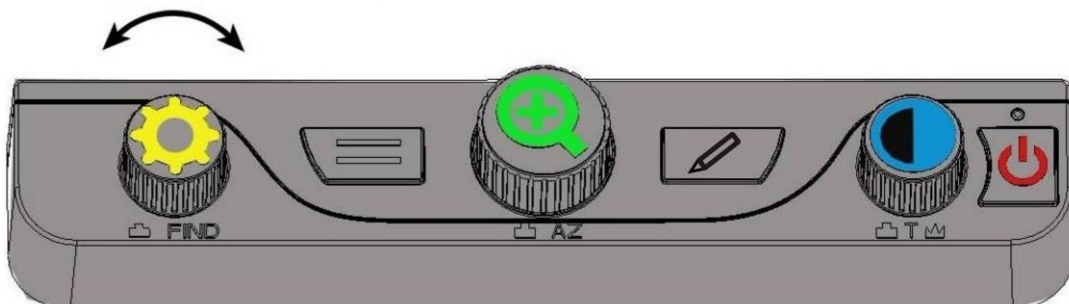

- Turn the **Brightness Dial** to shift the **Electronic Curtain** to the position you need.
- Keep pressing the **Electronic Curtain** Button until you hear “beep” . You see two lines on the screen. Turn the

**Brightness Dial** Button to adjust the distance between the lines as you desire.

- If you want to shift the Electronic Curtain to your desired position, please long press the **Electronic Curtain** Button until you hear “beep” and turn the **Brightness Dial** Button to make it.

## Focus Lock

- By default, the camera automatically focuses on the closest object in view. However, if you want to focus to remain on a specific object such as a document on the XY Table, you can turn on the Focus Lock feature. This prevents the camera from accidentally focusing on your hand or any other item that moves in front of the camera.
- During normal operation, it is recommended that you leave Focus Lock off. Please turn it on when writing or handwork.

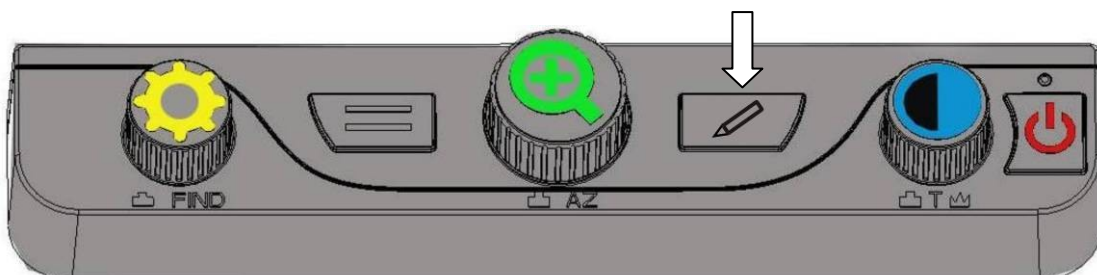

- Press the **Focus Lock** Button, the Focus Lock label “” appears on the screen. It means the Focus is locked.
- Press the **Focus Lock** Button again to exist from Focus Lock mode and go back to Auto Focus.

## Freeze Function/ Reset Factory Default Setting

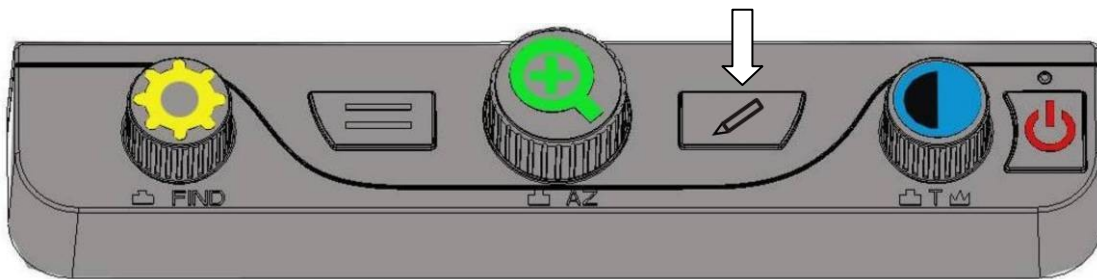

- Keep pressing the **Focus Lock** Button for 3 seconds until you hear “beep”. The text or image is captured temporarily. You can zoom in/ out or change color modes on the captured text/image. Short press the **Focus Lock** Button again to go back to normal text/ image viewing.
- Keep pressing the Focus Lock Button; you will hear two times of “beep”. Then, you see the Firmware Version Number indicated on the bottom of the screen. Please release your pressing. Now, Aurora HD turns to the factory default setting.

## Turn off the LED Light

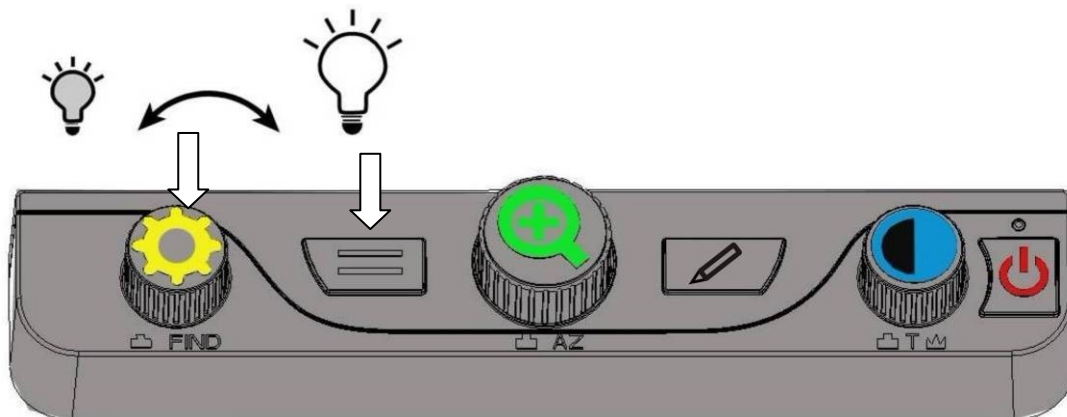

- Keep pressing the **Electronic Curtain Button**. Then turn the **Brightness Dial** to turn off the LED light or adjust the LED light brightness of LED light.

## Advanced Color Mode

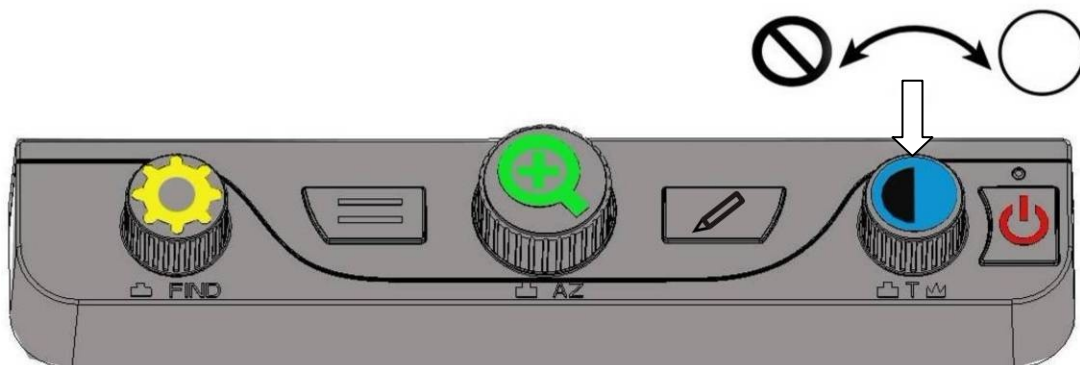

- Keep pressing the **Color Mode Dial** until you hear “beep” to enter into Advanced Color Mode. Turn the **Color Mode Dial** for 17 color mode options (Full Color, Black on White, Blue on White, Blue on Yellow, Black on Yellow, Black on Purple, Black on Light Blue, Black on Orange, Black on Green, White on Black, White on Blue,



Yellow on Blue, Yellow on Black, Purple on Black, Light Blue on Black, Orange on Black, Green on Black).

- Short press the **Color Mode Dial** Button to switch between full color and your favorite high contrast color.
- Keep pressing the **Color Mode Dial** Button again until you hear “beep” to go back to 5 Simplified Color Mode.

## Demo Mode

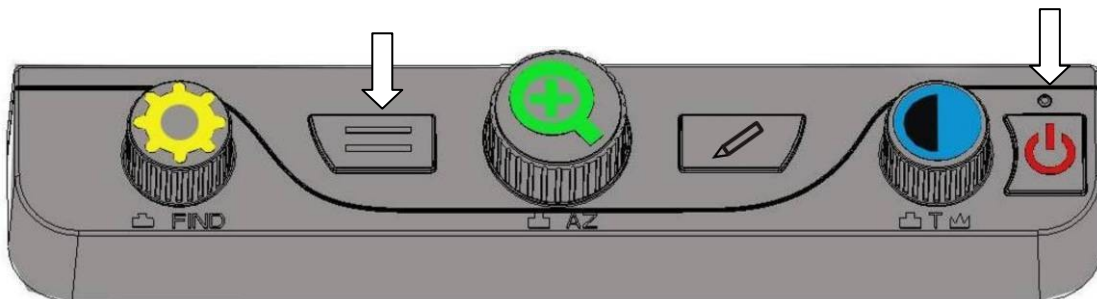

- In full color mode, keep pressing the **Electronic Curtain** Button until you hear “beep” to enter into Demo Mode. Then, Aurora HD demonstrates each function about itself automatically.
- Short press the **Power on/off** Button to exit from Demo Mode.

## 7. Specifications

- High Definition Camera, Resolution Ratio: 1280\*720;
- 18X Optical Focus;

- 24" LCD, Resolution Ratio: 1080 Full HD;
- Reading XY Table: A3 Size (290mm \* 420mm) ;
- Magnification Range: 2X – 70X;
- Image Refresh Rate: 1280\*720@60fps;
- Light Weight:14.8KG;
- Size: 540\*477\*360;
- Carton Size: 600\*480\*560;
- Power Adapter:
  - Put-in: 100-240V, 50/60HZ;
  - Put-out: 19V, 3A;
- Operation Conditions:
  - Temperature: +5° C~+40° C
  - Humidity: <70%;
- Storage Conditions:
  - Temperature: -10° C~+40° C
  - Humidity: <90%.



## **8. Important Safety Instructions**

- Read and follow all warning notices and instructions marked on the product or included in the manual.
- Slots and openings in the product are provided for

ventilation. To ensure reliable operation of the product and to protect it from overheating, these slots and openings must not be blocked or covered.

- Do not allow anything to rest on the power cord, and do not locate the product where people could trip over the power cord.
- Do not attempt to service this product yourself, as opening or removing covers may expose you to hazardous voltage or to other risks. Refer all servicing to qualified service personnel.
- When installed, the product must comply with the applicable Safety Standards and regulatory requirements of the country in which it is installed. If necessary, consult with the appropriate regulatory agencies and inspection authorities to ensure compliance.
- Always operate the product in a place where the temperature is between 10°C and 35°C.
- Keep it away from wet areas, rain, and other sources of liquids. Do not submerge the product.
- Do not stare directly at the light emitted by the reading lamp as the bright light may be harmful to the eyes.

## 9. Other Products from ZOOMAX

Item Name	Product Photo	Product Description
Snow 4.3"		<p>Snow is given the most advanced image technology and best camera. It offers sharp image even at the lowest magnification and under the fast movement. No learning but easy to use skillfully at the very beginning with the large button. You can read and write even when you are travelling.</p>
Capture 4.3"		<p>Capture can save up to 100 sharp pictures which keep your memory on the desired things no matter when and where you are. Compact and stylish wheel design expresses your unique character. Clearest image offers you an absolutely comfortable viewing experience.</p>
Butterfly 3.5"		<p>Pocketsize video magnifier, Butterfly is designed for the people's outdoor use. Because of its lightest weight and most compact size, Butterfly can be hung around the neck or kept in the pocket, handbag or even purse. You may use it to read price label, menu and see things around you anytime conveniently.</p>