

Programmable Logic Controller  
**MASTER-K120S Series**

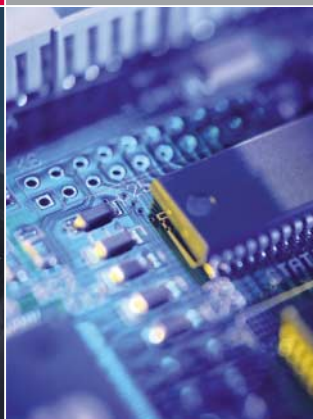

Automation Equipment



# Amazingly Powerful & Compact sized PLC

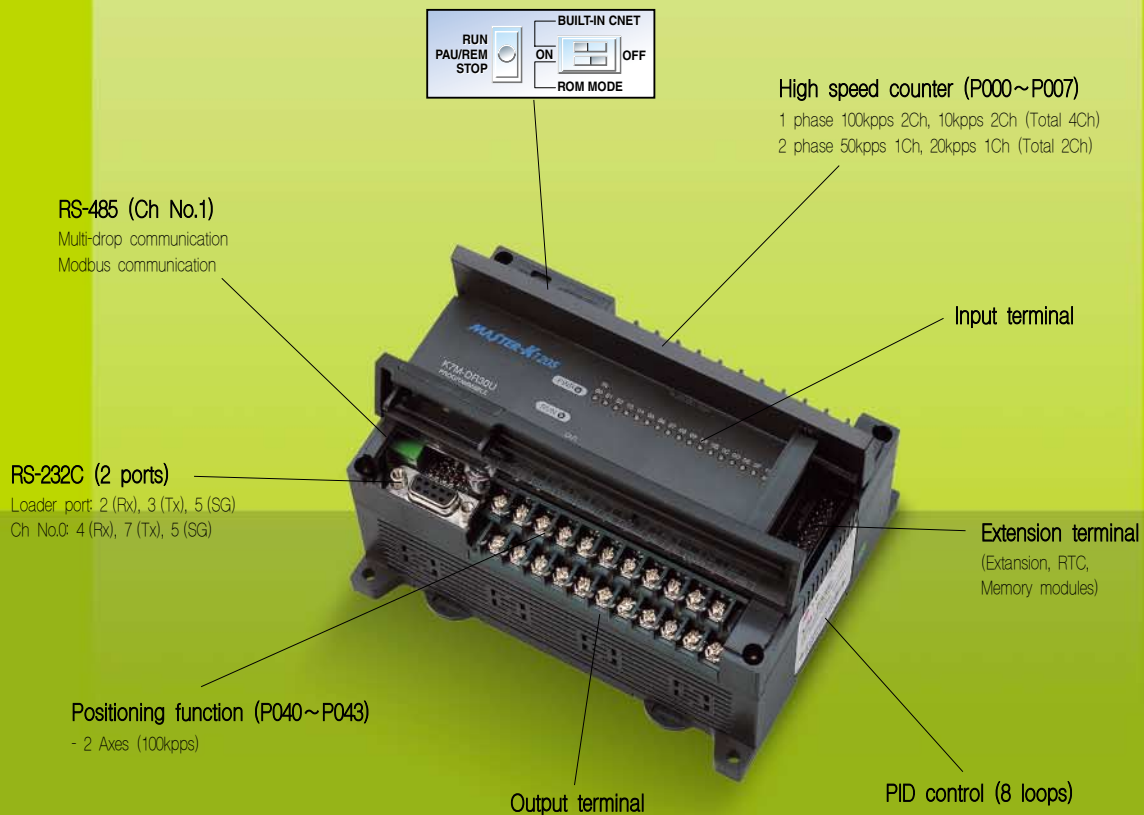

## CONTENTS

Features .....	4	Data register for special modules .....	23
System configuration .....	5	Communication interface .....	24
CPU specifications [Standard type] .....	6	Extension communication modules .....	25
CPU Specifications [Economic type] .....	8	Communication specifications .....	26
Digital I/O specifications (Relay) .....	9	Built-in/Communication module setting switch .....	26
Digital output specifications (TR output) .....	11	Network configuration .....	27
Wiring diagram .....	12	Cable connection .....	29
Built-in functions .....	14	Product list .....	30
Analog module .....	19	Dimensions .....	31
RTD module / Analog timer .....	22		

## ● Various base (main) units

Standard type	Economic type
• 20 points (I: 12, O: 8)	• 10 points (I: 6, O: 4)
• 30 points (I: 18, O: 12)	• 14 points (I: 8, O: 6)
• 40 points (I: 24, O: 16)	• 20 points (I: 12, O: 8)
• 60 points (I: 36, O: 24)	• 30 points (I: 18, O: 15)

## ● Processing speed

0.1 $\mu$ s / step  
(Economic type: 0.4 $\mu$ s / step)

## ● Program capacity

10 ksteps (Economic type: 2 ksteps)

## ● Battery-less backup

# MASTER-K120S

Dedicated basic function  
Powerful built-in functions  
Various extension  
modules



The best partner  
in price  
&  
performance



Digital I/O modules: 5 types



Special modules: 7 types  
(Analog I/O, Analog timer, Temperature)



Communication modules: 6 types

## ● Digital I/O modules

- G7E-DR10A (6/4)
- G7E-DR20A (12/8)
- G7E-TR10A (0/10)
- \* G7E-DC08A (8/0)
- \* G7E-RY08A (0/8)

## ● Special modules

- G7F-ADHA (AD: 2Ch / DA: 1Ch)
- \* G7F-ADHB (AD: 2Ch / DA: 2Ch)
- G7F-AD2A (AD: 4Ch)
- G7F-DA2I (DA: 4Ch, Current)
- \* G7F-DA2V (DA: 4Ch, Voltage)
- G7F-AT2A (4 points, 0 ~ 200)
- \* G7F-RD2A (4Ch)

## ● Communication modules

- G7L-CUEB: RS-232C 1Ch (Ch0)
- G7L-CUEC: RS-422 1Ch (Ch0)
- G7L-DBEA: DeviceNet slave (Ch0)
- G7L-PBEA: Profibus-DP slave (Ch0)
- G7L-FUEA: Fieldbus interface (Fnet, Ch0)
- G7L-RUEA: Fieldbus interface (Rnet, Ch0)

\*: Slim type

## Features

### ● Main unit

- Economic type: 10/14/20/30 points (10/14 points, built-in analog timer 2 points)
  - Total 70 points are available (up to 2 extension modules can be connected; only one communication module can be applied)
- Standard type: 20/30/40/60 points DR type, DRT type (DRT types have 4 transistor output points for positioning)
  - Total 120 points are available (up to 3 extension modules can be connected; only one communication module can be applied)
- Easy interface with SMART I/O (Rnet, Modbus) due to the increased P area (P000~P63F)

### ● High speed processing

- Basic commands: 0.1~0.9 $\mu$ s/step
- Application command: several  $\mu$ s~several tens of  $\mu$ s/step
- Special module processing: several hundreds of  $\mu$ s~1ms/module
  - \* Economic type: 0.4 $\mu$ s/step (Min.)

“Powerful  
built-in functions”

### ● Battery-less backup

- Program backup method: User program is automatically backed up in EEPROM (EEPROM backup while online editing)
- Data backup methods: Supercapacitor (over 2000hours at normal temperature)

### ● Compact extension modules

### ● Various input handling

- Input filter: Delay time can be set from 0ms to 1000ms (8 points unit)
- Pulse catch: 10 $\mu$ s (P0, P1), 50 $\mu$ s (P2~P7)
  - \* Economic type: 50 $\mu$ s (P0~P3)
- External interrupt: 10 $\mu$ s (P0, P1), 50 $\mu$ s (P2~P7)
  - \* Economic type: 50 $\mu$ s (P0~P3)

### ● Improved high speed counter function (32-bit signed counter)

- 1 Phase: 100kpps 2Ch, 20kpps 2Ch (Total 4Ch)
- 2 Phase: 50kpps 1Ch, 10kpps 1Ch (Total 2Ch)
- Additional functions: Ring counter, Comparison output, RPM, Latch counter, Preset function
  - \* Economic type → 1 phase: 20kpps (4Ch), 2 phase: 10kpps (2Ch)

### ● Positioning function (DRT type only)

- Control axis: 2 axes (100kpps)
- Operation mode: Single, Repeated, End, Keep, Cont
- Additional functions: Return to origin, JOG operation, Speed operation, PWM output

### ● Increased No. of communication channels and functions (Total 3 Channels)

- Supports built-in RS-232C/RS-485 (Total 2Ch)
- Supports no protocol mode and Communication monitoring for Ch0/1 (KGLWIN)
  - \* Economic type → K7M-DR10UE-14UE: 1 loader port and 1 RS-485 port (Total 2Ch)
  - K7M-DR20UE-30UE: 1 loader port and 1 RS-232C port (Pin No.: 4 (Rx), 7 (Tx), 5 (SG))

### ● Improved PID control function (Standard type only)

- Relay and PRC auto-tuning
- PWM output, Anti-derivative kick, Positioning/Velocity algorithm can be assigned





# System configuration

## System configuration

### Main modules

● Product type

- K7M-DR(T)20U: DC input 12 points / Relay 8 points / (Relay output 4 points / TR 4 points)
- K7M-DR(T)30U: DC input 18 points / Relay 12 points / (Relay output 8 points / TR 4 points)
- K7M-DR(T)40U: DC input 24 points / Relay 16 points / (Relay output 12 points / TR 4 points)
- K7M-DR(T)60U: DC input 36 points / Relay 24 points / (Relay output 20 points / TR 4 points)

### Number of available extension modules

- Digital I/O: 3 modules
- Special module: 3 modules
- Communication I/F: 1 module
- RTC module (1 module)
- Memory module (1 module)

- \* Standard type: Max. 3 extension modules are connectable
- \* Economic type: Max. 2 extension modules are connectable (RTC/Memory module and be added after extension modules)

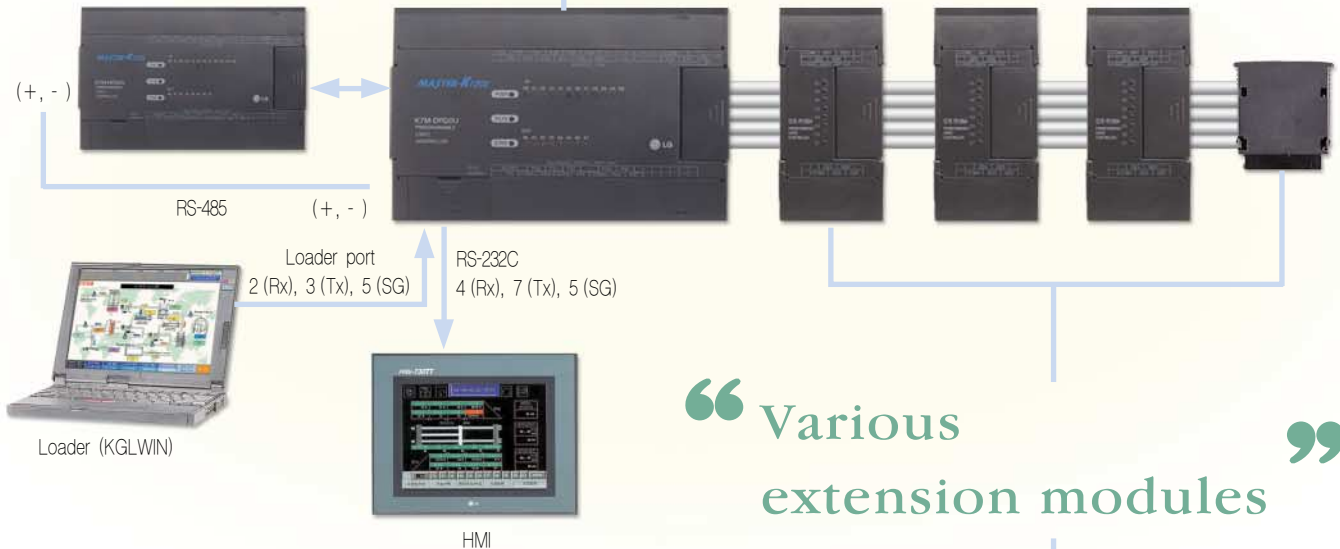

### Extension modules

● Digital input/output modules

- Input  
G7E-DC08A: DC input 8 points
- Output  
G7E-TR10A: TR output 10 points  
G7E-RY08A: Relay output 8 points
- Input/output hybrid module  
G7E-DR10A: DC 6 points / Relay 4 points  
G7E-DR20A: DC 12 points / Relay 8 points

● Special modules

- |              |                                |
|--------------|--------------------------------|
| A/D          | G7F-AD2A: 4Ch                  |
| D/A          | G7F-DA2V: 4Ch (Voltage output) |
|              | G7F-DA2I: 4Ch (Current output) |
| A/D, D/A     | G7F-ADHA: 2Ch/1Ch              |
|              | G7F-ADHB: 2Ch/2Ch              |
| RTD          | G7F-RD2A: 4Ch                  |
| Analog timer | G7F-AT2A: 4 points (0~200)     |

● Communication modules

- G7L-CUEB: RS-232C 1Ch
- G7L-CUEC: RS-422 1Ch
- G7L-FUEA: Fieldbus interface (Fnet)
- G7L-RUEA: Fieldbus interface (Rnet)
- G7L-DBEA: DeviceNet slave
- G7L-PBEA: Profibus-DP slave

● Other option modules

- G7E-RTCA: RTC module
- G7E-M256B: Memory module

# CPU specifications [Standard type]

## Specifications

Item	Specifications				Remark	
	K7M-DR20U	K7M-DR30U	K7M-DR40U	K7M-DR60U		
	K7M-DRT20U	K7M-DRT30U	K7M-DRT40U	K7M-DRT60U		
CPU operation method	Cyclic execution of stored program, Time-driven interrupt, Interrupt task operation					
I/O control method	Scan synchronized batch processing method (refresh method), Direct method by command					
Program language	Ladder Diagram, Instruction List					
Numbers of instruction	Basic	30				
	Application	277				
Processing speed	Basic command: 0.1μs/step					
Program capacity	10kstep					
I/O Points	20 points	30 points	40 points	60 points		
Memory device	P	P000~P63F			I/O relay	
	M	M000~M191F			Aux. relay	
	K	K000~K31F			Keep relay	
	L	L000~L63F			Link relay	
	F	F000~F63F			Special relay	
	T	100ms: T000~T191 10ms: T192~T250 1ms: T251~T255			Timer	
	C	C000~C255			Counter	
	S	S00.00~S99.99 (100×100 steps)			Step relay	
D	D0000~D4999			Data register		
Operation mode	RUN, STOP, PAUSE					
Self-diagnostic functions	Detect errors of scan time, Memory, I/O, Power supply					
Data backup method	Set by parameter					
Max. extension stage	3 (except RTC/Memory pack)					
Built-in functions	PID Control function	Control by command, Auto-tuning, PWM output Forced output, Set scan time anti-windup Delta MV function, SV-Lamp function				
	Cnet I/F Function	MASTER-K dedicated protocol support Modbus protocol support User-defined protocol support No protocol support			RS-232C 1 port RS-485 1 port	
	High speed counter	Capacity	1 Phase: 100kHz 2Ch / 20kHz 2Ch 2 Phase: 50kHz 1Ch / 10kHz 1Ch			
		Mode	It has 4 different counter functions • 1 phase, up-down by program • 1 phase, up-down by B-phase input • 2 phase, up-down by 1 phase • 2 phase, up-down by phase difference			
	Additional function	• Internal/External preset function • Latch counter function • Comparison output function • RPM function				

\* RTC/Memory module must be connected to the last extension terminal.

## ● Specification

Item		Specifications				Remark	
		K7M-DR20U	K7M-DR30U	K7M-DR40U	K7M-DR60U		
		K7M-DRT20U	K7M-DRT30U	K7M-DRT40U	K7M-DRT60U		
Built-in functions	Sitioning function	Basic function	No. of axis: 2 axes Control method: PTP/speed Control unit: Pulse Positioning data: 20 data per each axis (Step No: 1~20) Operation mode: End, Keep, Cont Control method: Single, Repeated, Operation				DRT Type only
		Positioning	Positioning method: Absolute method/Incremental method Address range: -2,147,483,648 ~ 2,147,483,647 Speed: Max. 100kpps (Speed: 5 ~ 100,000pps) Acceleration/Deceleration processing (Operation pattern: Trapezoidal method)				
		Return to origin	Origin detection when approximate origin turns off Origin detection after deceleration when approximate origin turns on				
		Jog	Speed setting range: 5 ~ 100,000pps (High/Low)				
	Pulse catch		Pulse width: 10 $\mu$ s 2 points (P0000~P0001) / 50 $\mu$ s 6 points (P0002~P0007)				
	External interrupt		8 points: 10 $\mu$ s 2 points (P0000~P0001) / 50 $\mu$ s 6 points (P0002~P0007)				
	Input filter		0, 1, 2, 5, 10, 20, 50, 100, 200, 500, 1000ms set by user				
	Weight (g)		520	540	660	850	

## ● CPU Operation mode

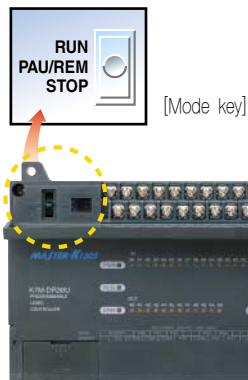

Mode key position	Operation mode
RUN	Local RUN
STOP	Local STOP
STOP → PAU/REM *	Remote STOP
PAU/REM → RUN	Local RUN
RUN → PAU/REM	Local PAUSE
PAU/REM → STOP	Local STOP

\* PLC operates continuously when changed from Remote RUN to Local RUN.  
Remote RUN/Remote STOP control is available in KGLWIN.

- **RUN Mode (Local RUN/Remote RUN):** operating mode; initialization of data area is executed when the first scan starts.
- **STOP Mode (Local STOP/Remote STOP):** program is not operated; program transferring in KGLWIN is available only in Remote STOP mode.
- **PAU (PAUSE):** program operation is temporarily stopped; if it returns to RUN mode, the operation will continue from the state before it stopped.
- **REM (Remote):** changeable mode to Remote RUN/STOP in KGLWIN

# CPU Specifications [Economic type]

## Specifications

Item	Specifications				Remark
	K7M-DR10UE	K7M-DR14UE	K7M-DR20UE	K7M-DR30UE	
CPU operation method	Cyclic execution of stored program, Time-driven interrupt, Interrupt task operation				
I/O control method	Scan synchronized batch processing method (refresh method), Direct method by command				
Program language	Ladder Diagram, Instruction List				
Numbers of instruction	Basic	30			
	Application	265			
Processing speed	Basic command: 0.4μs/step				
Program capacity	2kstep				
I/O points	10 points	14 points	20 points	30 points	
Memory device	P	P000~P63F			I/O relay
	M	M000~M191F			Aux relay
	K	K000~K31F			Keep relay
	L	L000~L63F			Link relay
	F	F000~F63F			Special relay
	T	100ms: T000~T191 10ms: T192~T250 1ms: T251~T255			Timer
	C	C000~C255			Counter
	S	S00.00~S99.99 (100×100 Steps)			Step relay
D	D0000~D4999			Data register	
Operation mode	RUN, STOP, PAUSE				
Self-diagnostic function	Detect errors of scan time, Memory, I/O, Power supply				
Data backup method	Set by parameter				
Max. extension stage	2 (except RTC/Memory pack)				
Built-in analog timer	2 points		None		
Input filter	0, 2, 5, 10, 20, 50, 100, 200, 500, 100ms set by user				
Interrupt	4 points (P0~P3), 50μs				
Pulse catch	4 points (P0~P3), 50μs				
Built-in function	Cnet I/F	Built-in RS-485		Built-in RS-232C	
		MASTER-K dedicated protocol (LG protocol)			
		Modbus protocol			
		User-defined protocol			
		No protocol support			
Weight (g)	520	540	660	850	

## Specifications

Type	Item	Specifications	Remark
Digital I/O module	G7E-DR10A	DC 24V input 6 points / Relay output 4 points	
	G7E-DR20A	DC 24V input 12 points / Relay output 8 points	
	G7E-TR10A	TR input 10 points	
	G7E-DC08A	DC 24V input 8 points	
	G7E-RY08A	Relay output 8 points	
Cnet interface module	G7L-CUEB	RS-232C 1Ch	
	G7L-CUEC	RS-422 1Ch	
RTC module	G7E-RTCA	RTC module	
Memory module	G7M-M256B	Memory module	

\* Special function modules are available after October, 2003.



# Digital I/O specifications (Relay)

## Digital input specifications

Specification	Model	Main unit				Extension module		
		K7M-DR20U	K7M-DR30U	K7M-DR40U	K7M-DR60U	G7E-DR10A	G7E-DC08A	G7E-DR20A
		K7M-DRT20U	K7M-DRT30U	K7M-DRT40U	K7M-DRT60U			
Input points		12 points	18 points	24 points	36 points	6 points	8 points	12 points
Insulation method	Photocoupler							
Rated input voltage	DC 24V							
Rated input current	7mA							
Operating voltage range	DC 20.4~28.8V (ripple rate < 5%)							
Max. simultaneous input points	100% Simultaneous on							
On Voltage/On current	DC 19V or higher / 5.7mA or higher							
Off Voltage/Off current	DC 6V or lower / 1.8mA or lower							
Input impedance	Approximate 3.3k $\Omega$							
Response time	Off $\rightarrow$ On	0, 1, 2, 5, 10, 20, 50, 100, 200, 500, 1000ms (default: 10ms), Set by user						
	On $\rightarrow$ Off	0, 1, 2, 5, 10, 20, 50, 100, 200, 500, 1000ms (default: 10ms)						
Common terminal		12 points/COM	18 points/COM	12 points/COM	18 points/COM	6 points/COM	4 points/COM	12 points/COM
Operating indicator	LED							

## Digital output specifications (Relay)

Specification	Model	Main unit				Extension module		
		K7M-DR20U	K7M-DR30U	K7M-DR40U	K7M-DR60U	G7E-DR10A	G7E-RY08A	G7E-DR20A
Output points		8	12	16	24	4	8	8
Insulation method	Relay insulation							
Rated load voltage/current	DC 24V/2A (Register load), AC 220V/2A (COS = 1)/1point 5A/COM							
Min. load voltage/current	DC 5V/1mA							
Max. load voltage/current	AC 250V, DC 110V							
Off leakage current	0.1mA (AC 220V, 60Hz)							
Max. on/off frequency	1,200/hr							
Surge absorber	None							
Service life	Mechanical	20 million times or more						
	Electrical	Rated load voltage/current: 100,000 or more AC 200V/1.5A, AC 240V/1A (COS = 0.7) 100,000 or more AC 200V/1A, AC 240V/0.5A (COS = 0.35) 100,000 or more DC 24V/1A, DC 100V/0.1A (L/R = 7ms) 100,000 or more						
Response time	Off $\rightarrow$ On	10ms or less						
	On $\rightarrow$ Off	12ms or less						
Operation indication	LED							

# Digital I/O specifications (Relay)

## Input circuit diagram

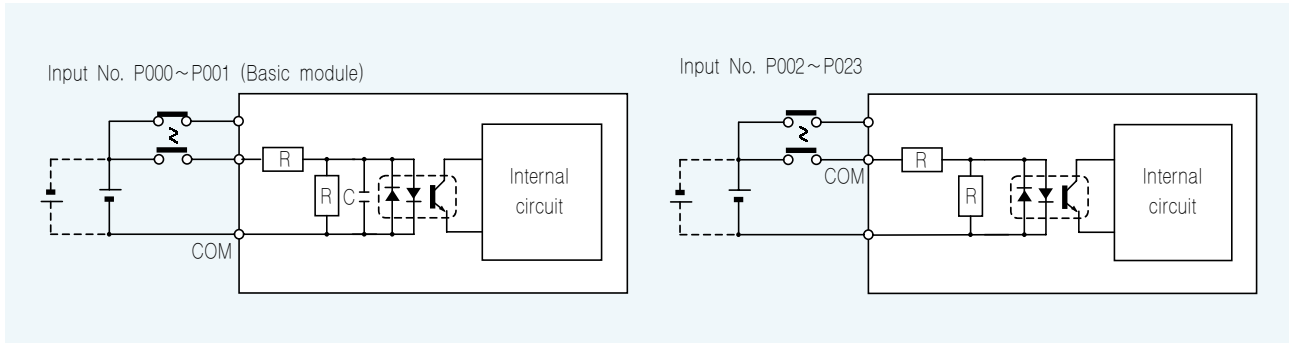

## Output circuit diagram

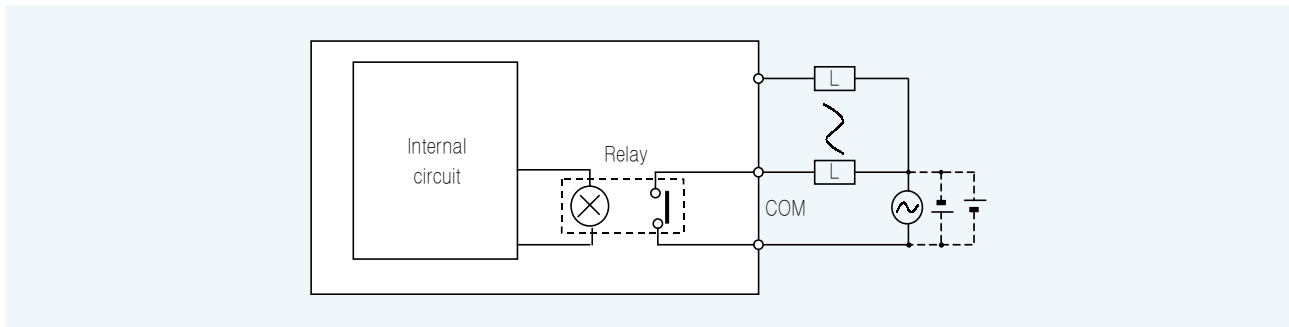

## Connection display of Digital input part

According to external equipment type, refer to the following connection between DC input part and external devices.

	External equipment (I/Os)	Input part		External equipment (I/Os)	Input part
Relay output type		IN CON	PNP Current output type		Uses the same power in input power and power for sensor IN CON-
NPN Open collector output type		IN CON+	Voltage output type		Uses the same power in input power and power for sensor CON+ IN
NPN Current output type		Uses the same power in input power and power for sensor IN CON+			

# Digital output specifications (TR output)

## Main module

Specification	Model	Main module				Extension unit
		K7M-DRT20U	K7M-DRT30U	K7M-DRT40U	K7M-DRT60U	G7E-TR10A
Relay output points		4 points	8 points	12 points	20 points	0 points
TR output points		4 points	4 points	4 points	4 points	0 points
Insulation method		Photocoupler				
Rated load voltage		DC 12/24V				
Input operation voltage range		DC 10.2~26.4V				
Max. load current		0.1A/point				0.5A/point, 4A/COM
Surge absorber		Zener diode				Clamp diode
Off leakage current		0.1mA or less				
Off voltage drop		DC 0.3V (0.1A) or less				DC 1.5A or less
Inrush current		4A, 10ms or less				
Response time	Off → On	0.2ms or less				2ms or less
	On → Off	0.2ms or less				2ms or less
Common method		1point/COM				10 points/COM
Operation indication		LED				

## Circuit diagram

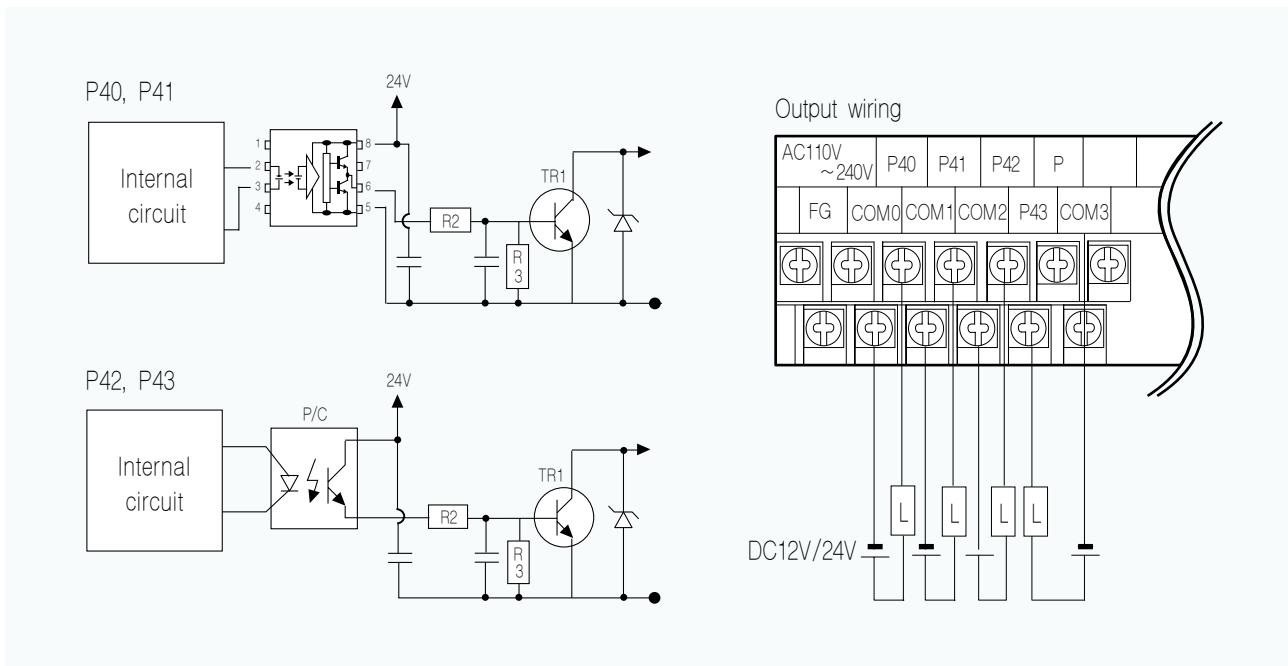

### Note

- P40~P43 of K7M-DRT□□U type are for positioning control TR output (These can be used as general TR output).
- TR parts would be damaged, when used for AC load.

**I/O Part (Main module)**

● K7M-DR20U

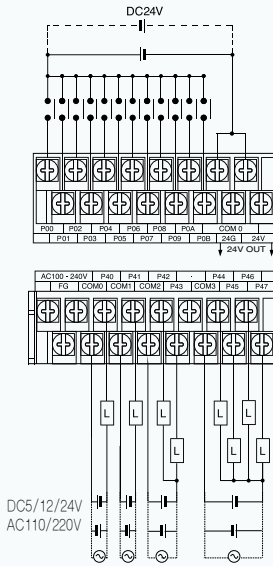

● K7M-DR30U

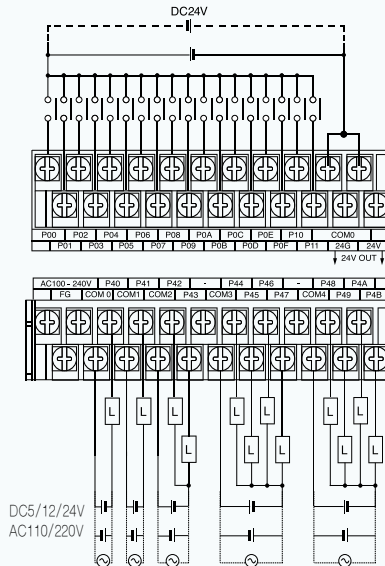

● K7M-DR40U

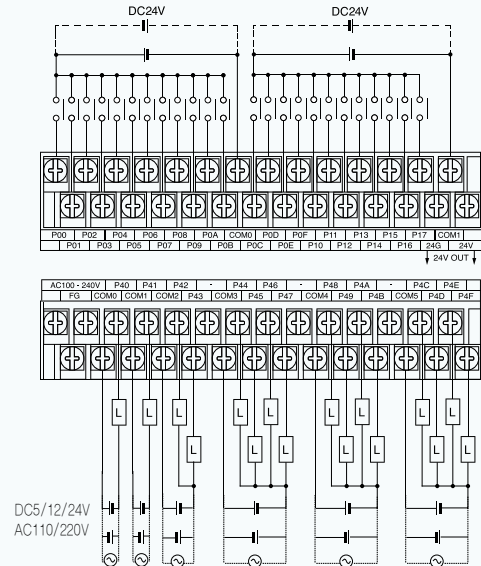

● K7M-DR60U

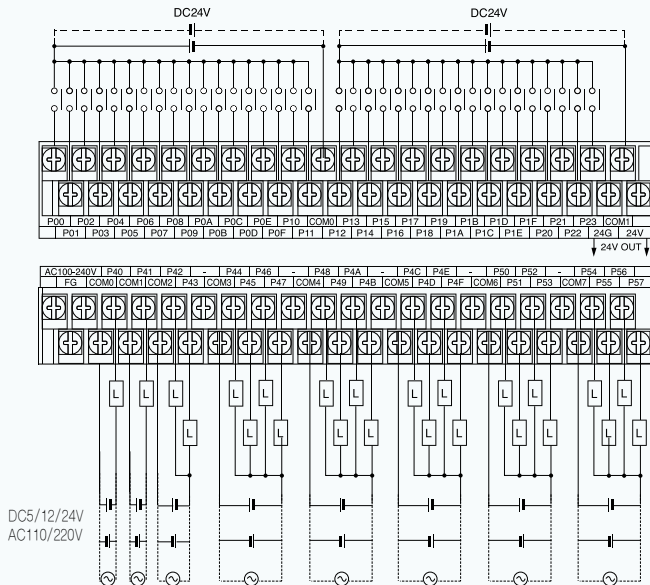

**I/O Part (Extension module)**

● G7E-DR10A

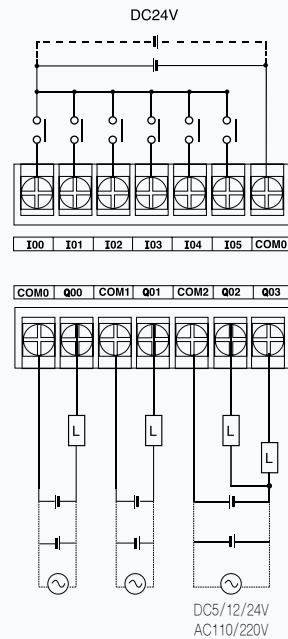

## I/O Part (Extension module)

- G7E-DR20A  
G7E-RY08A (Output)

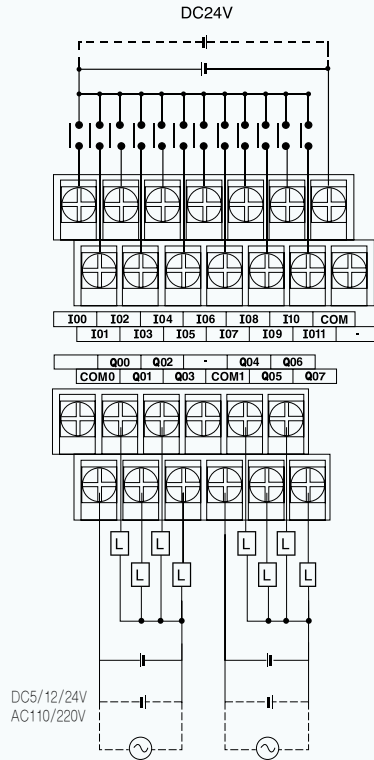

- G7E-TR10A

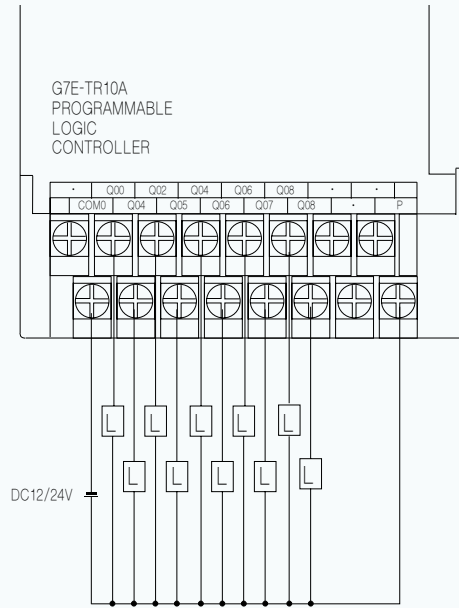

- G7E-DC08A

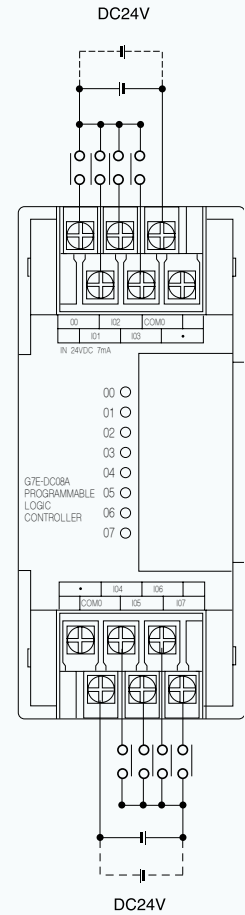

\* K7M-DRxxS/DC: PLC operating power is DC 24V.

### I/O allocation method

Addressing to each module for data output.

Items	Type	Area	Remark
Main	Input	P000~P03F	64 points
	Output	P040~P07F	64 points
Extension #1	Input	P080~P08F	16 points
	Output	P090~P09F	16 points
Extension #2	Input	P100~P10F	16 points
	Output	P110~P11F	16 points
Extension #3	Input	P120~P12F	16 points
	Output	P130~P13F	16 points
Special		-	A/D, A/T, Communication

Basically, I/O area is a fixed-point type. Special and communication modules have nothing to do with I/O allocation. Rest area can be used as internal relays.

Example)

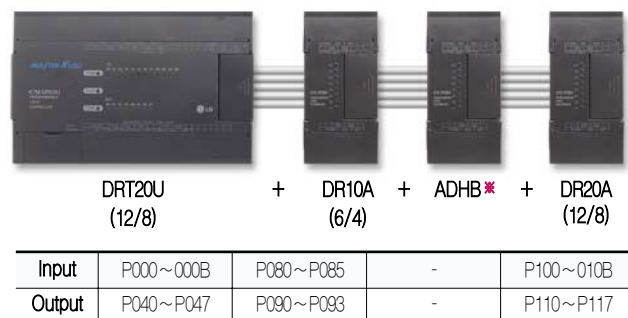

\* No allocation of I/O point



# Built-in functions

## Pulse catch function

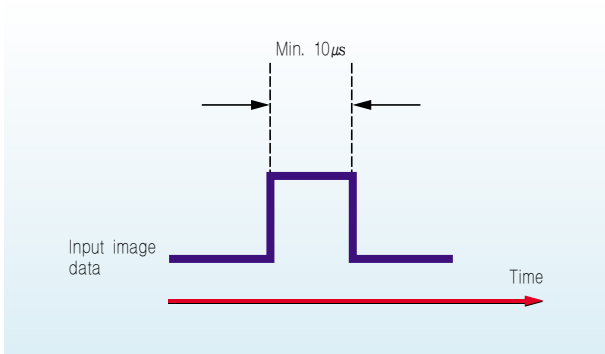

Using pulse catch function, a very short pulse signal can be taken as valid input signal which can't be executed by general digital input.

Pulse catch setting



- **Input point:**

- 8 points (P000 ~ P007)

- Input signal shorter than scan time can be detected.

## Input filter function

An input signal is valid after the setting time after an input filter signal becomes on.

The input image data turn off after the setting time after an input filter signal becomes off.

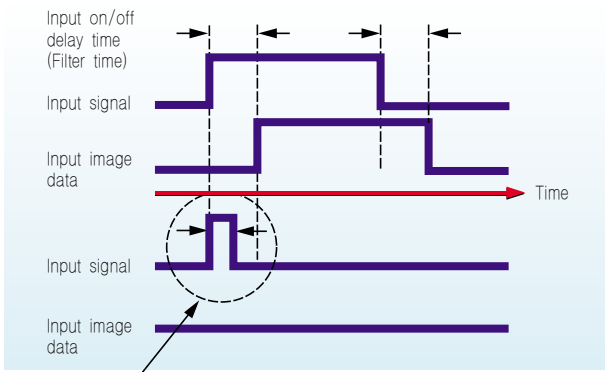

Setting

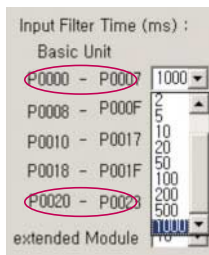

- **Useable input point:** All input points

- **Setting input filter time:** 8-point unit

- **Assignment by group** (Extension Input)

- **Setting range:** 0 ~ 1s

(0, 1, 2, 5, 10, 20, 50, 100, 200, 500, 1000ms)

Any input signal shorter than assigned on/off filter time from KGLWIN is ignored.

✳ Using input filter function, malfunction by noise can be prevented effectively.

## Interrupt function

MK120S can perform interrupt function using input points without any special interrupt module.

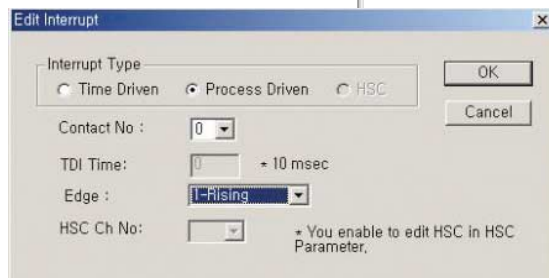
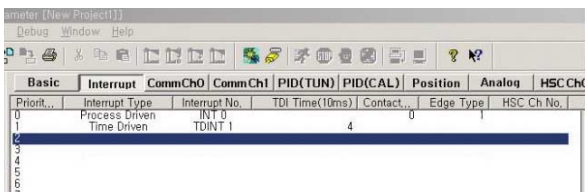

- **Input point:**

- Max. 8 points (P000 ~ P007)

- Rising, Falling, Rising & Falling

## High speed counter function

Using HSC function, High speed pulses which are generated from encoder of pulse generator can be counted.

### ● Function

Function	Description
Counter mode	4 counter modes are available as follows. • 1-phase operation mode: Increment count by program • 1-phase+ direction mode: Increment/decrement count by B-phase state • 2-phase CW/CCW mode: Increment/decrement count by input pulse • 2-phase multiplication mode: Increment/decrement count by phase difference
Latch counter	Counter latch function in power off or counter disable
Preset function	Change current value to preset value
Ring counter function	When counter value reaches set value, it rotates to 0
Comparison output	When counter value reaches set value, turns on output contact point of executes interrupt program.
RPM function	Calculates the RPM(Rotate per minute) of input pulse

### ● Specifications

Item	Specifications
Point	1-phase 4 points, 2-phase 2 points
Input signal	A-phase, B-phase, Preset input (P4 ~ P7)
Counting range	-2,147,483,648 ~ 2,147,483,647 (Binary 32 bit)
Counting speed	Ch0, Ch1(1-phase 100kpps / 2-phase 50kpps) Ch2, Ch3 (1-phase 20kpps / 2-phase 10kpps)
Additional function	Ring counter, Preset, Comparison output, RPM

### ● Input

#### 1) A/B-phase input

Item	Specifications
Rated input voltage/current	DC 24V (7mA)
On guaranteed voltage	20.4V ~ 28.8V
Off guaranteed voltage	Below 6V

#### 2) Preset input

Item	Specifications
Rated input voltage/current	DC 24V (7mA)
On guaranteed Voltage	20.4V ~ 28.8V
Off guaranteed Voltage	Below 6V
On delay time	Below 200μs
Off delay time	Below 200μs

### ● Input terminal diagram

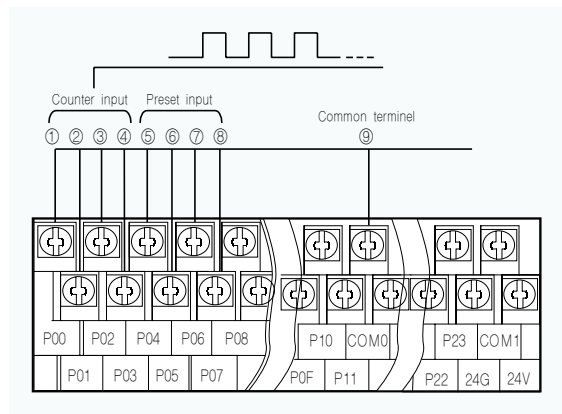

No.	Terminal No.	Name		Use	
		1 phase	2 phase	1 phase	2 phase
①	P000	Ch0 Counter input	Ch0 A-phase input	Counter input terminal	A-phase input terminal
②	P001	Ch1 Counter input	Ch0 B-phase input	Counter input terminal	B-phase input terminal
③	P002	Ch2 Counter input	Ch2 A-phase input	Counter input terminal	A-phase input terminal
④	P003	Ch3 Counter input	Ch2 B-phase input	Counter input terminal	B-phase input terminal
⑤	P004	Ch0 Preset 24V	Ch0 Preset 24V	Preset input terminal	Preset input terminal
⑥	P005	Ch1 Preset 24V			Preset input terminal
⑦	P006	Ch2 Preset 24V	Ch2 Preset 24V	Preset input terminal	Preset input terminal
⑧	P007	Ch3 Preset 24V			Preset input terminal
⑨	COM 0		Input Common	Common terminal	Common terminal

\* Refer to user's manual regarding detail specifications.

# Built-in functions

## ● Positioning control

The position of servo or stepping motor can be controlled by positioning function.

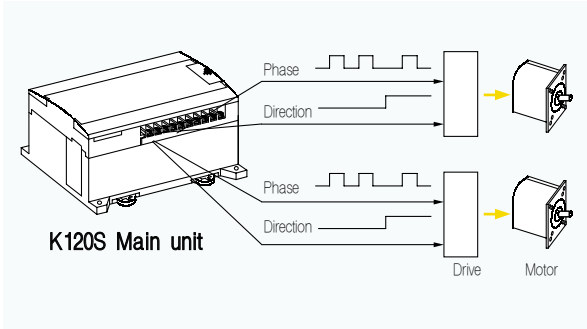

### ● Output

Signal name	Rated load voltage	Load voltage range	Max. loaded current	Max. voltage drop during On
Pulse output (forward pulse, reverse pulse)	DC 12/24V	DC 10.2~26.4V	100mA	≤ DC 0.3V
P40, P41				
P42, P43				

### ● Output terminal diagram

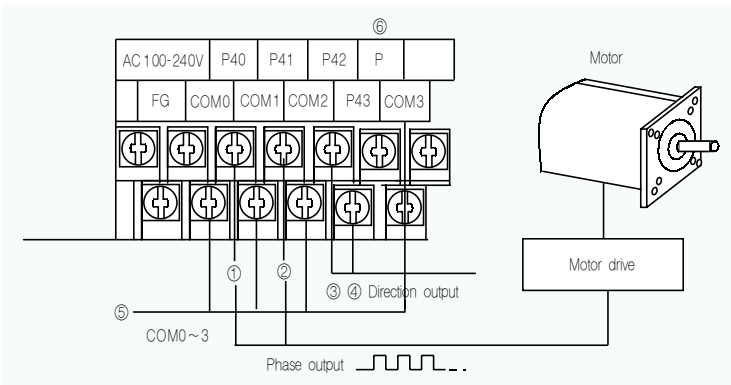

No.	Terminal No.	Name	Usage
①	P040	Positioning(Ch0)	Pulse output terminal
②	P041	Positioning(Ch1)	Pulse output terminal
③	P042	Direction pulse (Ch0)	Direction output terminal
④	P043	Direction pulse (Ch1)	Direction output terminal
⑤	COM	Common	Common terminal
⑥	P	24V	External 24V supply terminal

### ● Specifications

Item	Specifications		
No. of control axis	2 axes		
Control method	PTP (point-to-point), speed control		
Control unit	Pulse		
Positioning data	20 data per each axis (operation step number: 1~20)		
Positioning	Positioning method	absolute/incremental method	
	Address range	-2,147,483,648~2,147,483,647	
	Speed	Max. 100kpps, Speed range in setting: 5~100,000pps (unit of pulse)	
	Acceleration/Deceleration method	Operation pattern: Trapezoidal method Acceleration/deceleration time: 0~10,000ms (unit of 1ms)	
	Backlash compensation	0~1,000pulses	
	Bias speed	5~100,000pps	
	Speed limit	5~100,000pps	
Operation mode	End, Keep, Continuous operation		
Operation method	Single, Repeat operation		
Origin return	Speed	High/Low	Speed setting range: 5~100,000pps
	Dwell time		Setting range: 0~10,000ms
	Method	1	Origin detection when approximate origin turns off
		2	Origin detection after deceleration when approximate origin turns on
3		Origin detection by approximate origin	
JOG	Speed	High/Low	Speed setting range: 5~100,000pps
PWM output	Period setting range: 1~20,000ms		
	Duty setting range: 0~100%		

## Positioning control – wiring

### Wiring with DC5V

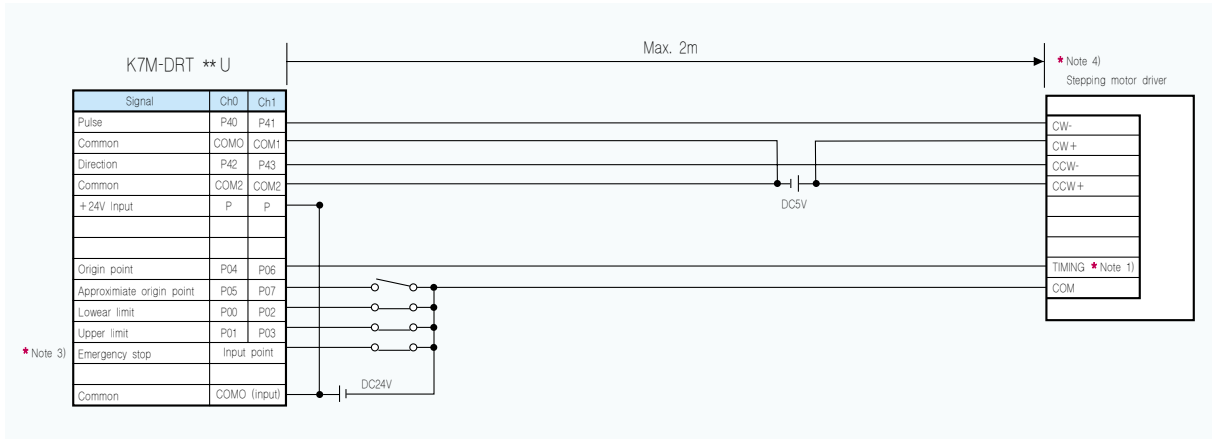

### Wiring with DC24V

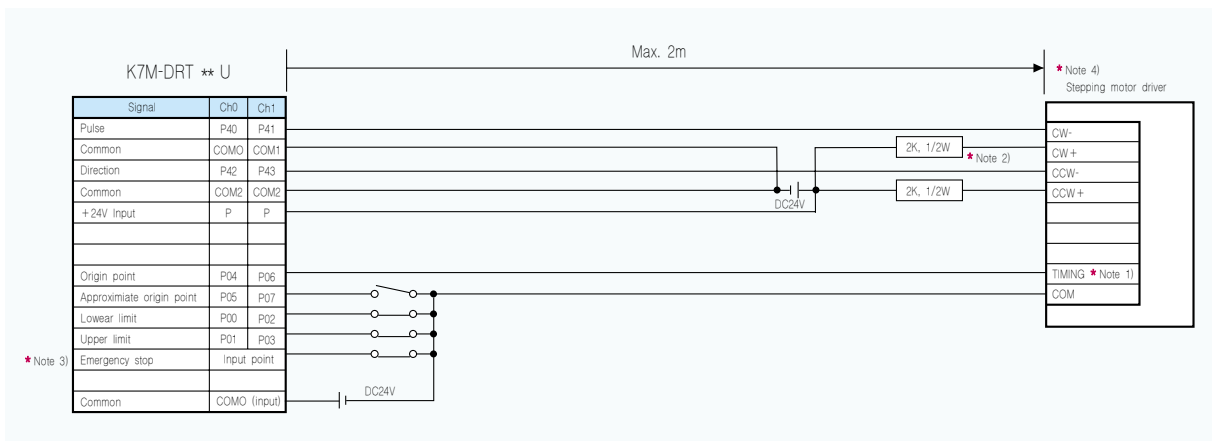

- \* Note 1) In case of VEXTA RK series, TIMING output turns on when a motor rotates at every 7.2 degree. For exact 'return to origin', we suggest you to configure 'AND' operation using TIMING output and the DOG sensor. It may be different to each system features to return to origin by the DOG sensor without TIMING output signal (The rated input for the origin of K120S is DC24V).
- 2. Using DC24V, wire a proper resistor to driver in series.
- 3. Input points for origin point, approximate origin point, and upper/lower limit signal are fixed but if they're not used, you are able to use them as general input points. You can use emergency stop with the command (POSCTR).
- 4. Positioning phase of K120S is as follows: Set the input mode of a step motor driver to 1 phase input mode because motor operation is determined by rotating direction input.

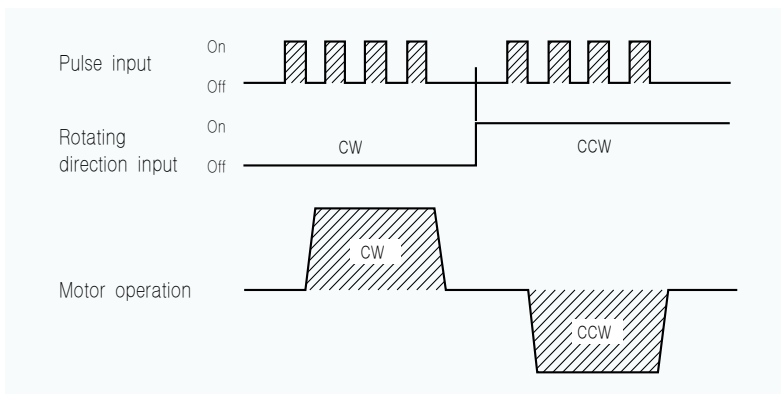

- \* The maximum connection cable between PLC and driver equipment is 2m. Please refer to user's manual for the connection with other servo drivers.

## Built-in functions

### PID Control

#### Features

- PID function is integrated into the main unit. And, all the PID functions can be performed with instruction (PID8, PID8AT).
- P operation, PI operation and on/off operation can be selected easily.
- Manual output (user-defined forced output) is available.
- By proper parameter setting, it can keep stable operation regardless of external disturbance.
- The operation scan time (the interval that PID controller gets sampling data from an actuator) is changeable for optimizing the system characteristics.
- PWM (pulse width modulation) output is available

\* P, I, and D value are automatically calculated by auto-tuning.

#### System

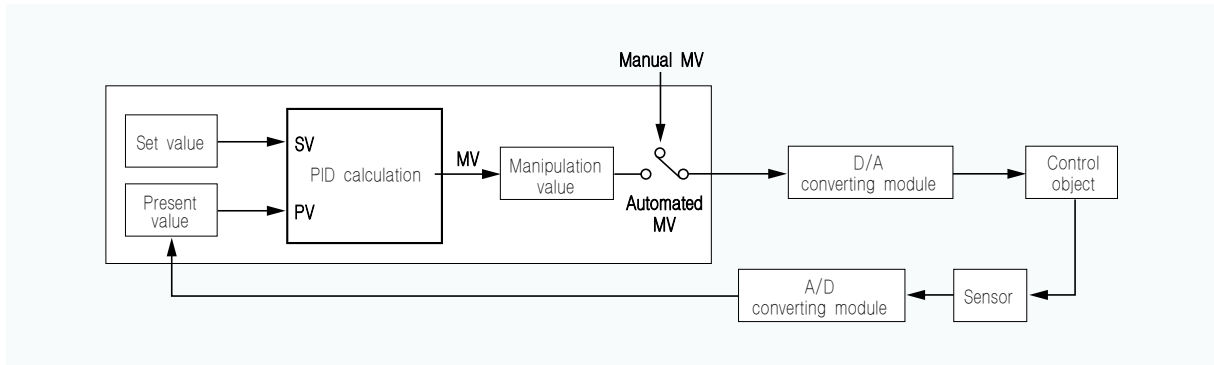

#### Specifications

Item	Specifications	
No. of PID loop	8 loops	
PID	Proportional value	1~10,000 (100-time scaled up), D area
	Integral value	1~20,000 (100-time scaled up), D area
	Differential value	1~20,000 (100-time scaled up), D area
Setting value	0~4,000, D area	
Present value	0~4,000, D area	
Manipulation value	0~4,000, D area	
Manual operation value	0~4,000, D area	
Control action	P, PI, PID, P_PWM, PI_PWM, PID_PWM, On-Off	
Scan time	1~100 (0.1 second unit), D area	
Processing type	Velocity type, Position type	

#### Example

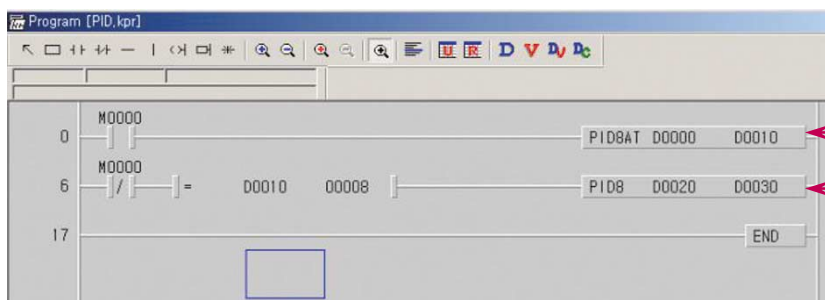

← Auto-tuning: P, I and D values calculated automatically

← PID operation



# Analog module

## Specifications

Item		A/D · D/A Hybrid module		A/D Module	D/A Module			
		G7F-ADHA	G7F-ADHB	G7F-AD2A	G7F-DA2I	G7F-DA2V		
Analog input	Input range	Voltage	DC 0~10V (input resistance: more than 1MΩ)					
		Current	DC 0~20mA (input resistance 250Ω) DC 4~20mA (input resistance 250Ω) Classified by parameter					
	Digital output	12 bits (0~4,000)						
	Voltage/current selection		Set by jumper pin for V/I selection upper part of product (Up: V, Down: I)	Set by dip S/W for V/I selection on left side of product (left: V, Right: I)	Set by input terminal (When current input is used, short the V and I terminal)			
		V/I selected by KGLWIN parameter Short the V and I terminal when current input is used.						
	No. of channel	2Ch/module		4Ch/module				
	Absolute max. Input	V	DC +12V		DC ±15V			
I		DC +24mA		DC +25mA				
Analog output	Output range	V	DC 0~10V (External load resistance 2KΩ~1MΩ)		DC 0~20mA (load resistance 510Ω) DC 4~20mA (load resistance 510Ω)	DC 0~10V (load resistance 2KΩ~1MΩ)		
		I	DC 0~20mA (External load resistance 510Ω) DC 4~20mA (External load resistance 510Ω) Classified by parameter					
	Digital input	12 bits (0~4,000)						
	Voltage/current selection	Separated from terminal						
	No. of channel	1Ch/module	2Ch/module	4Ch/module				
	Absolute max. output	V	DC +12V				DC +24mA	DC +12V
		I	DC +24mA					
Common	Max. resolution	V	DC 0~10V: 2.5mV (1/4000)		DC 0~20mA: 5μA (1/4000)	25mV (1/4000)		
			DC 0~20mA: 5μA (1/4000)					
		I	DC 4~20mA: 6.25μA (1/3200)		DC 4~20mA: 6.25μA (1/3200)			
	Accuracy	±0.5% (full scale)			0.5%			
	Max. conversion speed	1ms/Ch+scan time			500ms/Ch+scan time	1ms/Ch+scan time		
	Insulation	Photocoupler insulation between I/O terminal and PLC power supply (Non-insulation between channels).						
	Connect terminal	9 points 2 terminals	8 points 2 terminals	2 points/16 points terminals	16 points terminal	8 points 2 terminals		
	Internal current consumption	20mA	20mA	100mA	20mA	15mA		
	External power supply	V	DC 21.6~26.4V					
		I	80mA	95mA	100mA	80mA	90mA	
Weight	240g		180g	300g	280g	160g		

※ Caution for wiring

- 2-core, shielded twisted pair cable is recommended.

Size: AWG22 (0.3mm) or higher.

- Wiring with high voltage or generation line, it makes induction failure which may cause malfunction or be out of order.

# Analog module

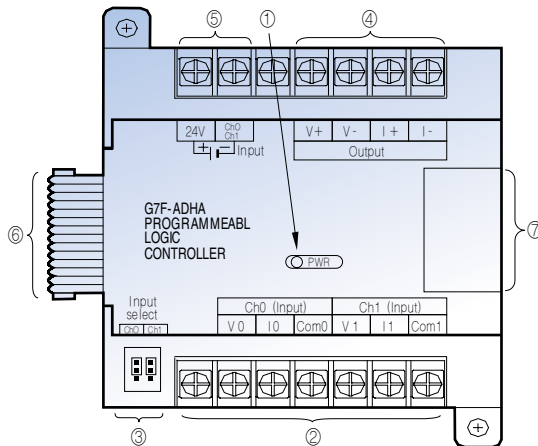

## Names of parts and functions

G7F-ADHA

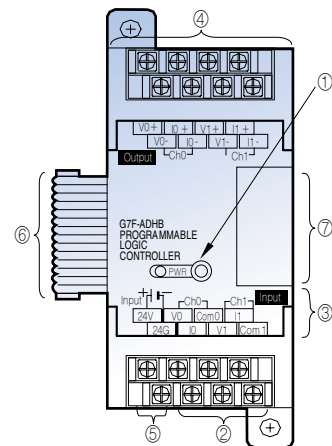

G7F-ADHB

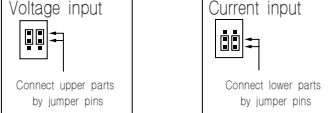
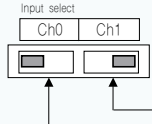
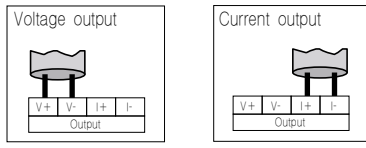

No.	Name	G7F-ADHA/G7F-ADHB
①	PWR LED	Indicate the operating status.
②	Analog input terminal	When current input is used, Short the V and I terminal. 
③	Jumper pin of analog input	Connect upper parts by jumper pins.  Right: Ch1 Left: Ch0  Connect upper parts by jumper pins Connect lower parts by jumper pins
③'	Dip switch of analog input	S/W to choose voltage or current.  Right: Current Left: Voltage
④	Analog Output terminal	Terminal to output analog signal.  Voltage output Current output G7F-ADHB has 2 output channels so it can select voltage/current respectively.
⑤	External power input terminal	External voltage 24VDC needs to this terminal.
⑥	Extension cable	The cable is used to connect while an analog mixture module is used.
⑦	Extension cable connector	The connector connects extension cable when an extension module is used.

● Names of parts and functions

G7F-AD2A

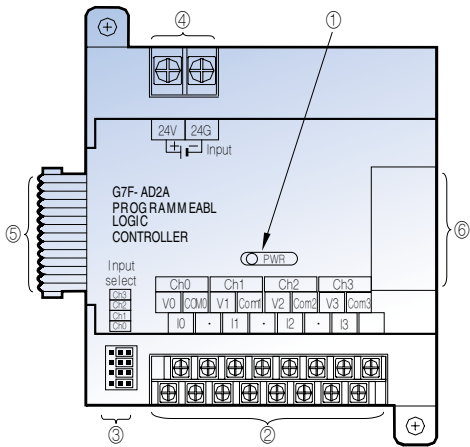

G7F-DA2I

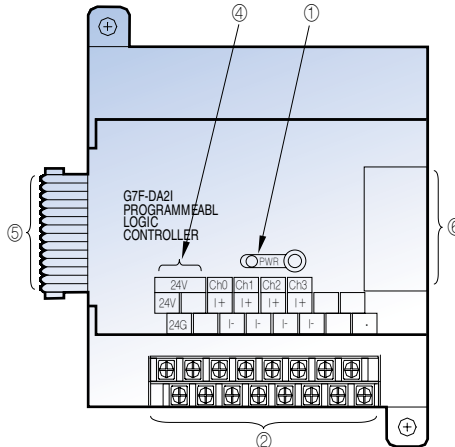

G7F-DA2V

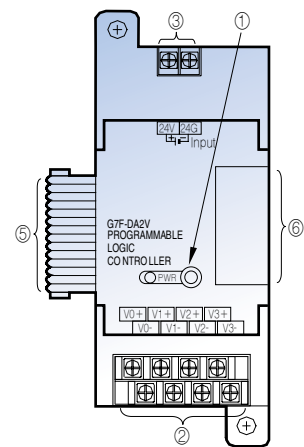

No.	Name	G7F-AD2A	G7F-DA2I/G7F-DA2V
①	PWR LED	Indicate the operating status.	
②	Analog input terminal	<p>Analog input terminal.</p> <p>• When current input is used, short the V and I terminal</p>	
③	Jumper pin of analog input	<p>Jumper pin of analog input (V/I).</p> <p>Connect left parts by jumper pin (Voltage input) Connect right parts by jumper pin (Current input)</p>	-
④	External power input terminal	External voltage 24VDC needs to this terminal.	
⑤	Extension cable	The cable is used to connect while an analog mixture module is used.	
⑥	Extension cable connector	The connector connects extension cable when an extension module is used.	

# RTD module / Analog timer

## Specifications (G7F-RD2A)

Item	Specifications
Connectable RTD	<ul style="list-style-type: none"> <li>• Pt100 (JIS C1640-1989, DIN 43760-1980)</li> <li>• JPt100 (KS C1603-1991, JIS C1604-1981)</li> </ul>
Temperature input range	<ul style="list-style-type: none"> <li>• Pt100: -200~600°C (18.48 to 313.59 ℚ)</li> <li>• JPt100: -200~600°C (17.14 to 317.28 ℚ)</li> </ul>
Digital output	<ul style="list-style-type: none"> <li>• Digital conversion value: 0~4,000</li> <li>• Detected temperature value: -2000~6000 (10-time scaled up value)</li> </ul>
Burnout detection	Each of three wires at every channel has detection function
Accuracy	±0.5% (Full scale)
Maximum conversion speed	40scan/module
Number of temperature input device points	4 channels/module
Insulation method	Photocoupler insulation between the input terminal and PLC power supply (Non-insulation between channels)
Connection terminal block	Two 8-point terminal blocks
Internal current consumption	25mA
External power supply	V DC 21.6~26.4V
	I 70mA
Weight	240g

## Names of parts and functions

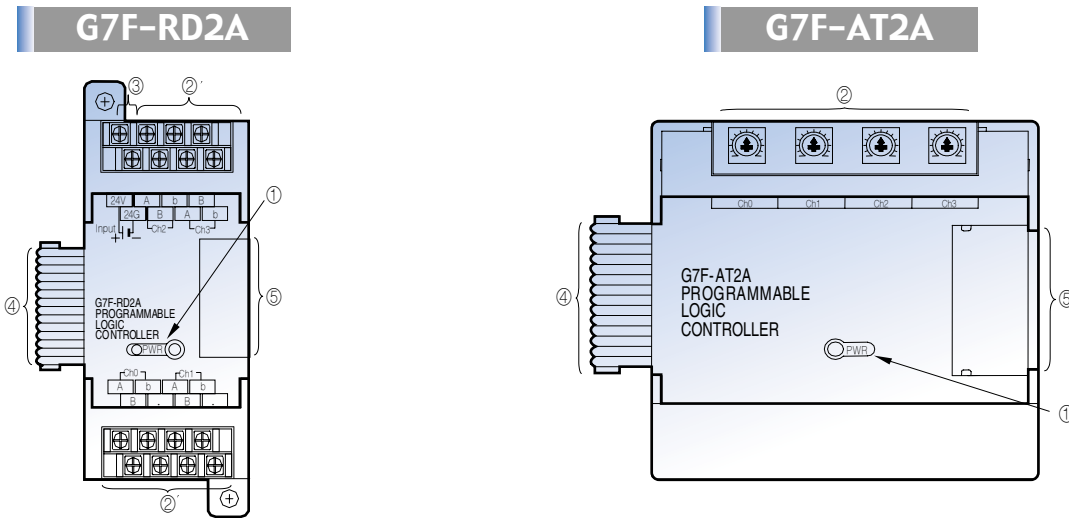

## Specifications (G7F-AT2A)

No.	Name	G7F-AT2A	G7F-RD2A
①	RUN LED		Indicate the operation status
②	Timer volume	Timer setting per channel by adjustment of variable resistor	-
②'	RTD input terminal	-	Terminal block which connects Pt100 ℚ or JPt 100 100 ℚ
③	External power input		External voltage 24VDC needs to this terminal
④	Extension cable	This cable is used to connect while an extension module is used	
⑤	Extension cable connector	This connector connects the extension cable when an extension module is used.	

Item	Specification
Channels	4
Output value range	8 bits (0 ~ 200)
Setting type	Setting by variable resistance
Accuracy of timer	±2.0% (Accuracy about max. value)
Internal current consumption	50mA
Weight	200g

# Data register for special modules

Data register for special extension modules.

Data register	Extension position	Hybrid module		A/D module	D/A module		Analog timer	RTD input module
		G7F-ADHA	G7F-ADHB	G7F-AD2A	G7F-DA2I	G7F-DA2V	G7F-AT2A	G7F-RD2A
D4980	Special Module #1	Ch0 A/D Conversion value	Ch0 A/D Conversion value	Ch0 A/D Conversion value	Ch0 D/A Conversion value	Ch0 D/A Conversion value	Ch0 A/T Conversion value	Ch0 Temp value
D4981		Ch1 A/D Conversion value	Ch1 A/D Conversion value	Ch1 A/D Conversion value	Ch1 D/A Conversion value	Ch1 D/A Conversion value	Ch1 A/T Conversion value	Ch1 Temp value
D4982		Ch0 D/A Conversion value	Ch0 D/A Conversion value	Ch2 A/D Conversion value	Ch2 D/A Conversion value	Ch2 D/A Conversion value	Ch2 A/T Conversion value	Ch2 Temp value
D4983		- Conversion value	Ch1 D/A Conversion value	Ch3 A/D Conversion value	Ch3 D/A Conversion value	Ch3 D/A Conversion value	Ch3 A/T Conversion value	Ch3 Temp value
D4984	Special Module #2	Ch0 A/D Conversion value	Ch0 A/D Conversion value	Ch0 A/D Conversion value	Ch0 D/A Conversion value	Ch0 D/A Conversion value	Ch0 A/T Conversion value	Ch0 Temp value
D4985		Ch1 A/D Conversion value	Ch1 A/D Conversion value	Ch1 A/D Conversion value	Ch1 D/A Conversion value	Ch1 D/A Conversion value	Ch1 A/T Conversion value	Ch1 Temp value
D4986		Ch0 D/A Conversion value	Ch0 D/A Conversion value	Ch2 A/D Conversion value	Ch2 D/A Conversion value	Ch2 D/A Conversion value	Ch2 A/T Conversion value	Ch2 Temp value
D4987		- Conversion value	Ch1 D/A Conversion value	Ch3 A/D Conversion value	Ch3 D/A Conversion value	Ch3 D/A Conversion value	Ch3 A/T Conversion value	Ch3 Temp value
D4988	Special Module #3	Ch0 A/D Conversion value	Ch0 A/D Conversion value	Ch0 A/D Conversion value	Ch0 D/A Conversion value	Ch0 D/A Conversion value	Ch0 A/T Conversion value	Ch0 Temp value
D4989		Ch1 A/D Conversion value	Ch1 A/D Conversion value	Ch1 A/D Conversion value	Ch1 D/A Conversion value	Ch1 D/A Conversion value	Ch1 A/T Conversion value	Ch1 Temp value
D4990		Ch0 D/A Conversion value	Ch0 D/A Conversion value	Ch2 A/D Conversion value	Ch2 D/A Conversion value	Ch2 D/A Conversion value	Ch2 A/T Conversion value	Ch2 Temp value
D4991		- Conversion value	Ch1 D/A Conversion value	Ch3 A/D Conversion value	Ch3 D/A Conversion value	Ch3 D/A Conversion value	Ch3 A/T Conversion value	Ch3 Temp value

In RTD module, following data register are allocated.

Extension position	Temp. value				Digital conversion			
	Ch0	Ch1	Ch2	Ch3	Ch0	Ch1	Ch2	Ch3
Special module #1	D4980	D4981	D4982	D4983	D4780	D4781	D4782	D4783
Special module #2	D4984	D4985	D4986	D4987	D4784	D4785	D4786	D4787
Special module #3	D4988	D4989	D4990	D4991	D4788	D4789	D4790	D4791

● Various ranges of input/output

Module	Channels	Range of Input/output
G7F-DA2V	4Ch	DC 0~10V
G7F-DA2I	4Ch	DC 4~20mA, DC 0~20mA
G7F-AD2A	4Ch	DC 0~10V, DC 4~20mA, DC 0~20mA
G7F-ADHA	Input: 2Ch Output: 1Ch	DC 0~10V, DC 4~20mA, DC 0~20mA
G7F-ADHB	Input: 2Ch Output: 2Ch	DC 0~10V, DC 4~20mA, DC 0~20mA
G7F-RD2A	4Ch	Pt100, JPt100

## Information

- Offset/Gain value is fixed and unchangeable.
- Analog input is set up to current initially.
- Max. 3 modules are extendible.



# Communication interface

## ● Provides three communication channels

: Built-in three communication channels

- ① Loader port: Pin No. 2 (Rx), 3 (Tx), 5 (SG)
- ② RS-232C port: Pin No. 4 (Rx), 7 (Tx), 5 (SG)
- ③ +, -: RS-485 port

## ● Provides various functions

: Various and easy communication interface with dedicated mode, Modbus, User-defined mode, No protocol mode

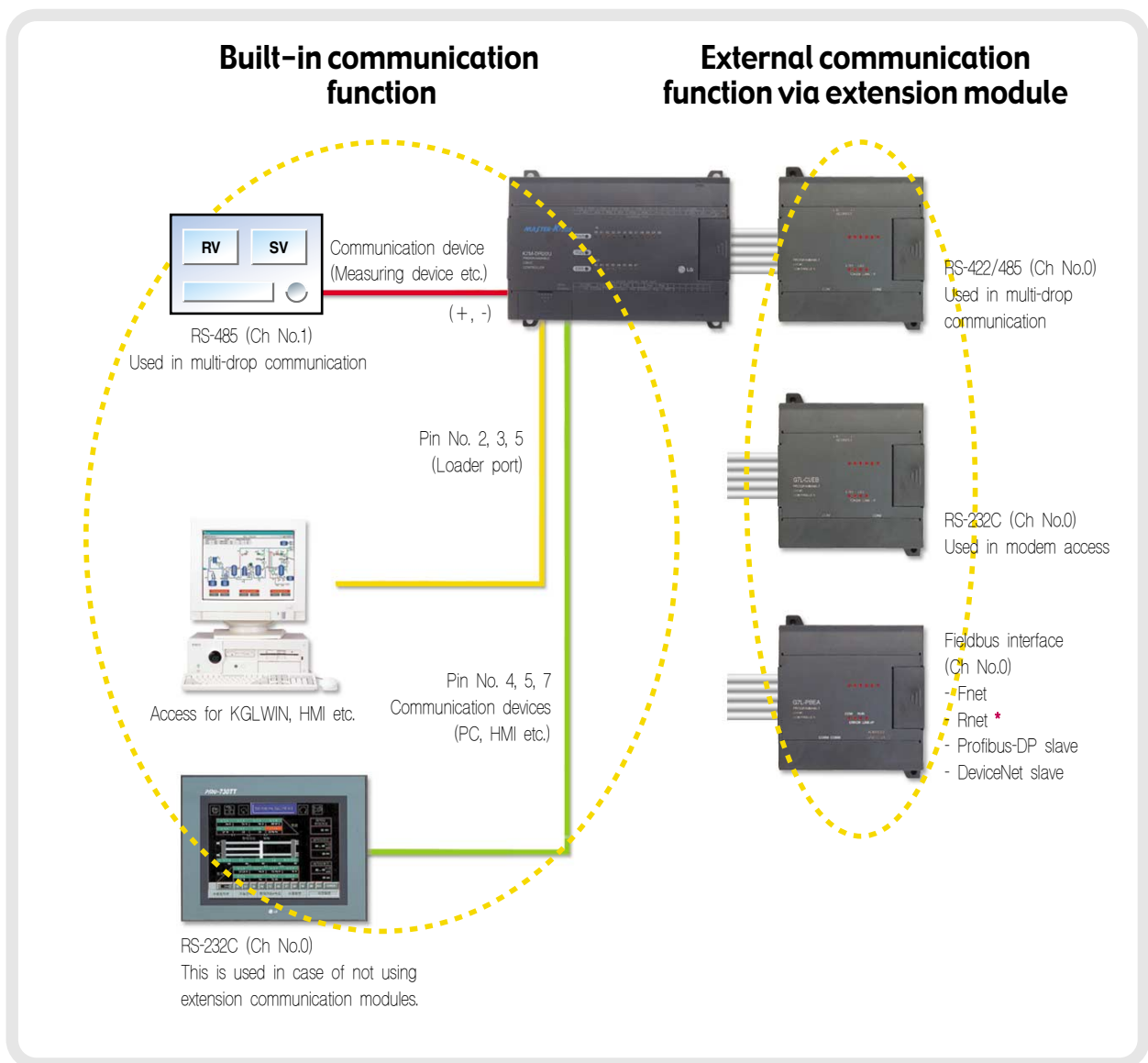

\* Rnet is a dedicated protocol for LGIS SMART I/Os.

## Extension communication modules

### Cnet modules (G7L-CUEB, G7L-CUEC)



Item		Specifications
Interface		G7L-CUEB: RS-232C (Modem)
		G7L-CUEC: RS-422/485
Communication mode	Dedicated mode	Supports 1-to-1, 1-to-N and high-speed link
	KGLWIN mode *	Supports remote programming and mounting via KGLWIN
	Modbus mode	Supports master and slave function with Modbus protocol (ASCII, RTU)
	User-defined mode	Supports user-defined communication
Data structure	Data bit	7 or 8
	Stop bit	1 or 2
	Start bit	1 or 2
	Parity bit	EVEN/ODD/NONE
Synchronization		Asynchronous method
Transmission speed		1,200 / 2,400 / 4,800 / 9,600 / 19,200 / 38,400 / 57,600bps
Setting method		Communication parameter setting in KGLWIN
Distance		Max. 15m (CUEB), Max. 500m (CUEC)
Max. number of stations		Max. 32 stations
Weight		180g

\* A dial-up modem is not available in KGLWIN mode.

### Fnet/Rnet module (G7L-FUEA/RUEA) \*



Item		Specifications
Transmission speed		1Mbps
Communication	Segment	Max. 750m
	Repeater (up to 6)	Max. 5.25km
Max. number of stations		Max. 64 stations
Setting method		Communication parameter setting in KGLWIN
Cable		Shielded twisted pair cable
Weight		220g

\* Rnet is a dedicated protocol for LGISSMART I/Os.

### Pnet module (G7L-PBEA)



Item		Specifications
Network type		Profibus-DP (Slave)
Protocol		EN50170/DIN19245
Media access		Token passing & Poll
Transmission and speed		1200m (9.6~187kbps) / 400m (500kbps) / 200m (1.5Mbps) / 100m (3~12Mbps)
Max. Node	Network	127 stations
	Segment	32 stations
Interface		RS-485 (electric)
Setting method		Communication parameter setting in KGLWIN
Cable		Shielded twisted pair cable
Weight		210g

### Dnet module (G7L-DBEA)



Item		Specifications			
Network structure		Trunk/drop line			
Protocol		Peer explicit message, Predefined explicit message			
		Predefined I/O message (poll, bit strobe, COS, cyclic)			
Max. extension & speed	Speed	Network distance	Drop cable	Total drop cable	
	500kbps	100m or less	6m or less	39m or less	
	250kbps	250m or less	6m or less	78m or less	
125kbps	500m or less	6m or less	156m or less		
Channel		64 stations			
Diagnosis function		CRC error check/Scan list			
Setting method		Communication parameter setting in KGLWIN			
Cable		5 lines (signal 2 lines, power 2 lines, shield 1 line)			

\* Only 1 communication module is available and the built-in Cnet is not available with it.  
RS-485 communication (Ch No.1) is available.

# Communication specifications

## Specifications

Item	Specifications	Remarks	
Built-in (Ch0, Ch1)	Dedicated	It is LGIS dedicated protocol for easy communication with LG products. (Supports high-speed link)	* Please refer to K120S user's manual regarding LG protocol.
	Modbus	It supports Modbus, Modicon PLC's communication protocol. (It supports ASCII mode and RTU mode)	
	User-defined	User-defined protocol allows users to communicate with other devices.	
	No protocol	No protocol communication is useful when communication between K120S and other devices which do not have protocol (It communicates with other devices by frames which are set by total size of communication bytes or user-defined code).	
Communi- cation module (Ch0)	Cnet	RS-232C: Communication using a modem RS-422/485: Support all the built-in functions	In case of using the built-in communication Ch No.0 (4, 5, 7), a communication module is not available and vice versa.
	Fnet	LGIS dedicated network between LGIS PLCs for high speed link	
	Rnet	LGIS dedicated network with SMART I/Os	
	Dnet	DeviceNet interface (slave)	
	Pnet	Profibus-DP interface (slave)	
Loader port	- KGLWIN connection - HMI connection		

## Built-in/Communication module setting switch

### Structure

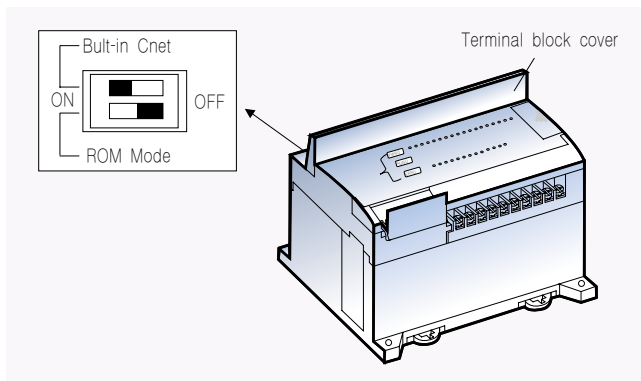

### Information

- \* ROM mode function  
ROM mode on: when power on, the program saved in the flash memory operates  
ROM mode off: when power on, it starts to drive a program saved in RAM

### Built-in Cnet

Dip switch	Contents
<p>Built-in/Communication module setting switch</p>	Set for using built-in RS-232C (Using pin No. 4, 7, 5 of loader port)
<p>Built-in/Communication module setting switch</p>	Can't use the built-in RS-232C (Set for communication module)

- \* Ch0: No. 4, 5, 7 of 9 Pin (communication module is not available in case of using the built-in Ch0 of Cnet)  
Ch1: RS-485 (communication module available simultaneously)

# Network configuration

## Remote communication using a modem

- Extension communication module (G7L-CUEB)

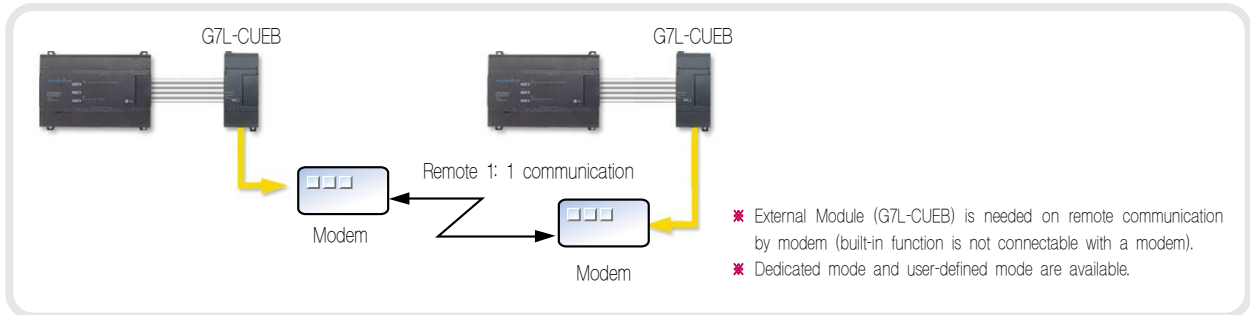

## Multi-drop communication (2 Ways)

- Built-in function / Communication module (G7L-CUEC)



Networking is available by DeviceNet / Profibus-DP slave

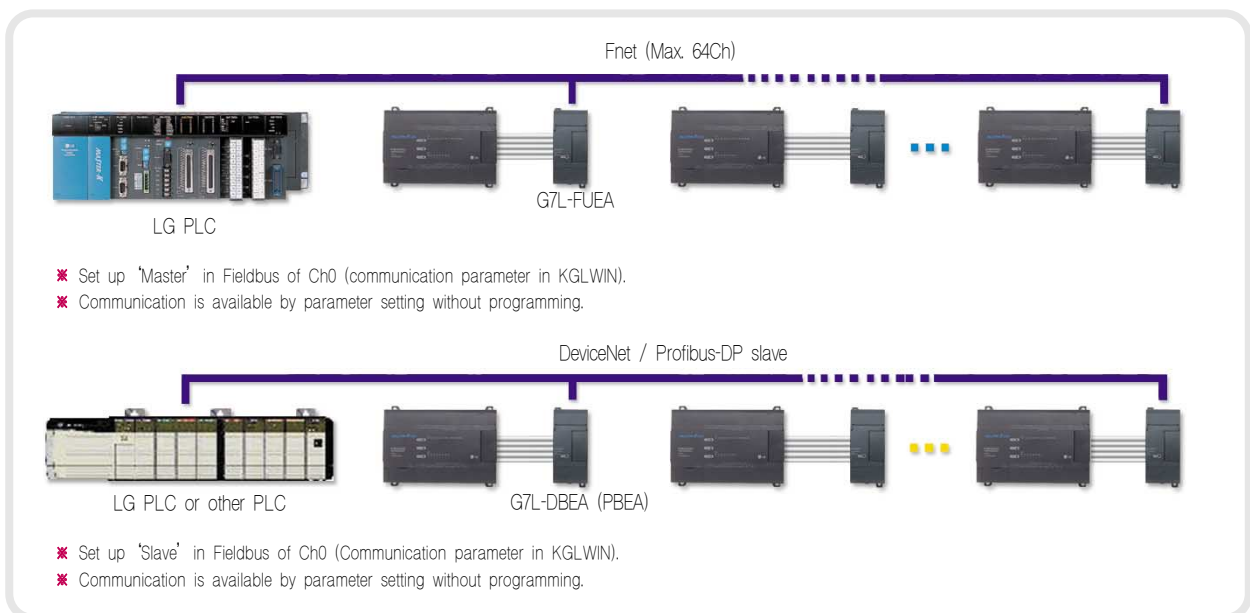

# Network configuration

1,024 points control is available in networking with SMART I/O

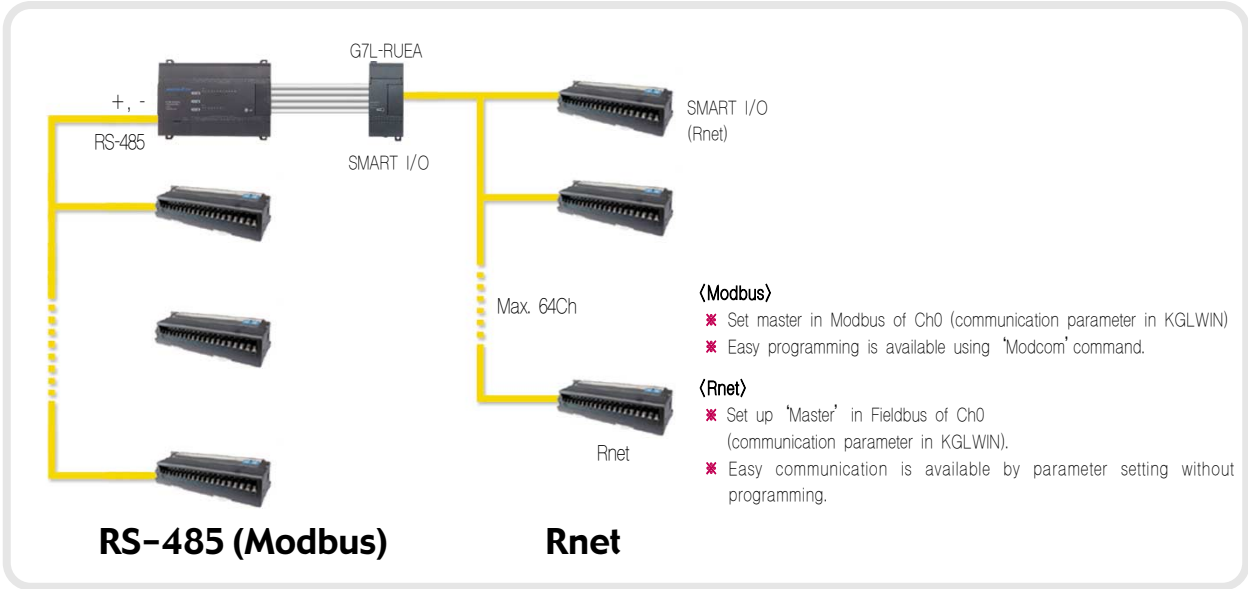

## Remote connection in KGLWIN

: Remote connection in KGLWIN is available in both built-in communication and communication module (dedicated protocol).  
 KGLWIN is connectable to any channel in network (program unload/download/monitoring are usable).  
 You can connect to any channel using KGLWIN (program upload/download/monitor, etc).

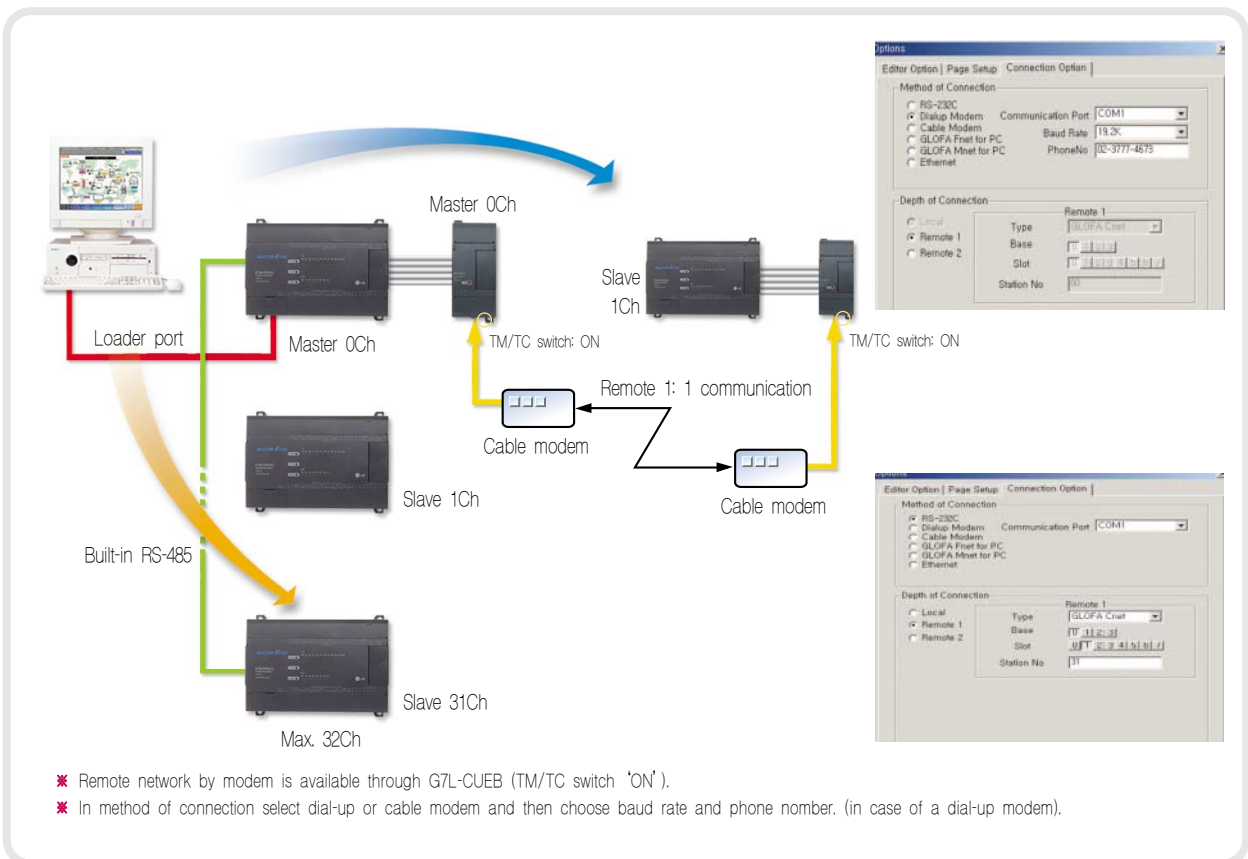

- ✖ Remote network by modem is available through G7L-CUEB (TM/TC switch 'ON').
- ✖ In method of connection select dial-up or cable modem and then choose baud rate and phone number. (in case of a dial-up modem).



# Cable connection

## Diagram

### Loader cable (Download cable)

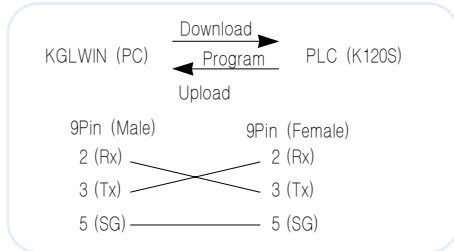

### Cnet (Built-in)

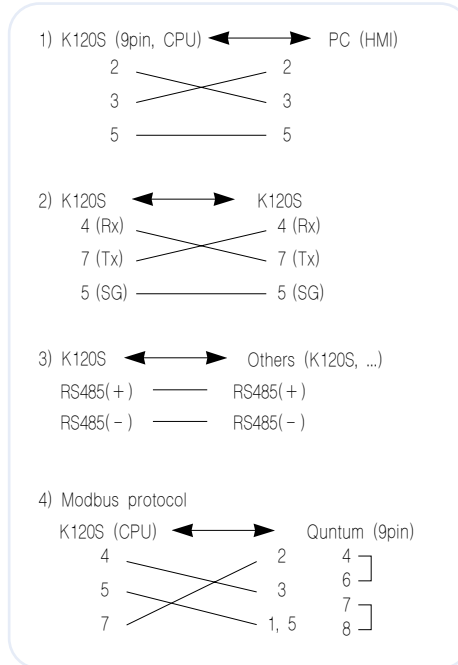

### Cnet (External)

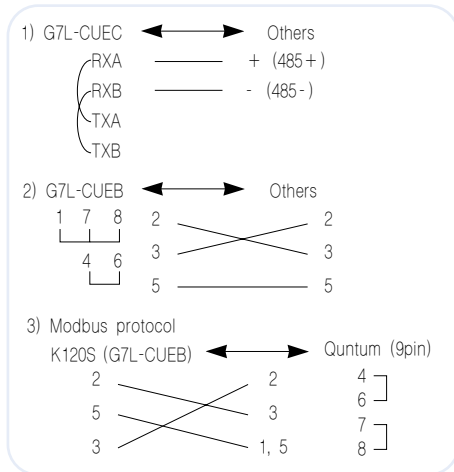

### Modbus (RS-232) ↔ SMART I/O (9pin, Male)

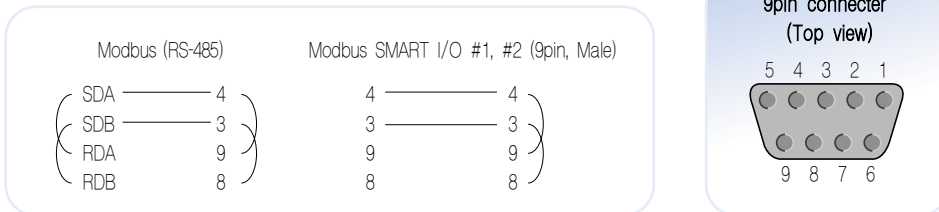

### Rnet Cable

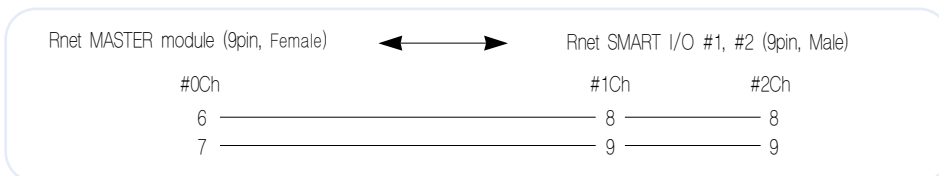

### Pnet Cable

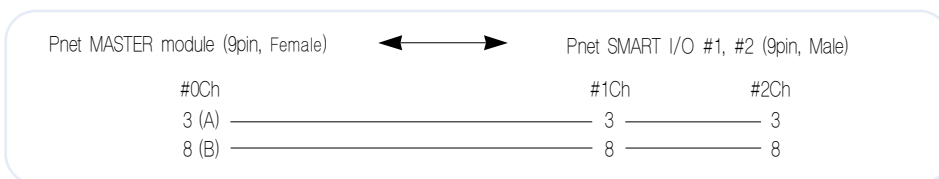

## Product list

### ● K120S

Type	Item	Specifications	Remarks	
Basic	Economic	K7M-DR10JE	AC 110/220V, DC 24V Input 6 points/Relay output 4 points	
		K7M-DR14JE	AC 110/220V, DC 24V Input 8 points/Relay output 6 points	
		K7M-DR20JE	AC 110/220V, DC 24V Input 12 points/Relay output 8 points	
		K7M-DR30JE	AC 110/220V, DC 24V Input 18 points/Relay output 12 points	
	Standard	K7M-DR20U	AC 110/220V, DC 24V Input 12 points/Relay output 8 points	
		K7M-DR30U	AC 110/220V, DC 24V Input 18 points/Relay output 12 points	
		K7M-DR40U	AC 110/220V, DC 24V Input 24 points/Relay output 16 points	
		K7M-DR60U	AC 110/220V, DC 24V Input 36 points/Relay output 24 points	
		K7M-DRT20U	AC 110/220V, DC 24V Input 12 points/Relay output 4 points/TR output 4 points	Position control
		K7M-DRT30U	AC 110/220V, DC 24V Input 18 points/Relay output 8 points/TR output 4 points	
		K7M-DRT40U	AC 110/220V, DC 24V Input 24 points/Relay output 12 points/TR output 4 points	
		K7M-DRT60U	AC 110/220V, DC 24V Input 36 points/Relay output 20 points/TR output 4 points	
		K7M-DT20U *	AC 110/220V, DC 24V Input 12 points/TR output 8 points	
		K7M-DT30U *	AC 110/220V, DC 24V Input 18 points/TR output 12 points	
		K7M-DT40U *	AC 110/220V, DC 24V Input 24 points/TR output 16 points	
		K7M-DT60U *	AC 110/220V, DC 24V Input 36 points/TR output 24 points	
Extension	Input / output	G7E-DR10A	DC 24V Input 6 points/Relay input 4 points	
		G7E-DR20A	DC 24V Input 12 points/Relay input 8 points	
		G7E-TR10A	TR output 10 points	
		G7E-DC08A *	DC 24V Input 8 points	Slim type
		G7E-RY08A *	Relay input 8 points	
		G7E-DR08A *	DC 24V input 4 points/Relay output 4 points	
	G7F-ADHA	A/D: 2Ch D/A: 1Ch		
	G7F-ADHB	A/D: 2Ch D/A: 1Ch	Slim type	
	G7F-AD2A	A/D: 4Ch		
	G7F-AD2B *	A/D: 4Ch	Slim type	
	G7F-DA2I	D/A: 4Ch (Current output)		
	G7F-DA2IA *	D/A: 4Ch (Current output)	Slim type	
	G7F-DA2V	D/A: 4Ch (Voltage output)		
	G7F-AT2A	4 points (0~200)		
	G7F-RD2A	4Ch	Slim type	
	Communi- cation	G7L-CUEB	RS-232C 1Ch	
		G7L-CUEC	RS-422C 1Ch	
		G7L-DBEA	DeviceNet slave interface module	
		G7L-PBEA	Profibus-DP slave interface module	
		G7L-FUEA	Fieldbus interface module (Fnet)	
		G7L-RUEA	Fieldbus interface module (Rnet)	
	RTC	G7E-RTCA	RTC module	
Memory	G7M-M256B	Memory module (256K)	Program back-up	

\* Due on the market soon.

# Dimensions

## Main unit

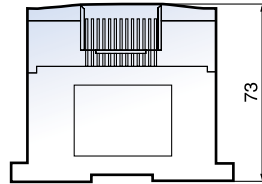
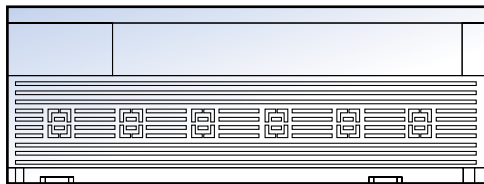
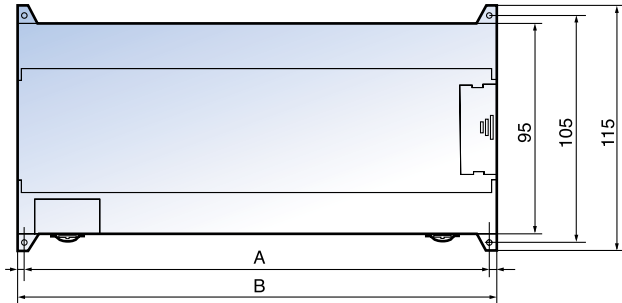

Unit	10/14 points	20/30 points	40 points	60 points
A	85	135	165	215
B	95	145	175	225

## Extension unit

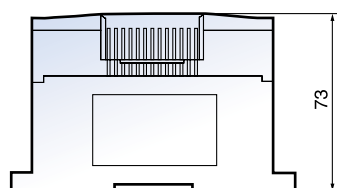
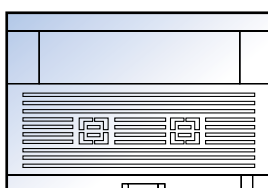
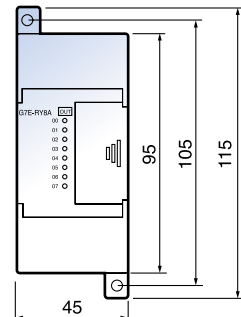
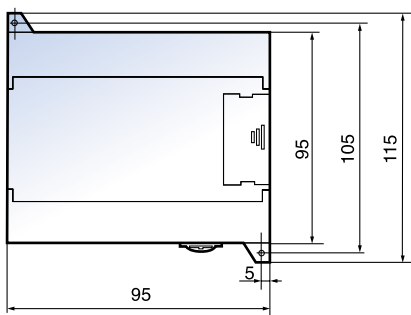

Standard

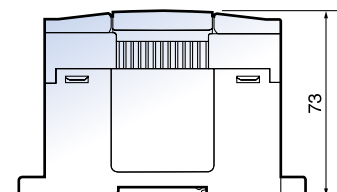
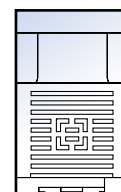

Slim

## Leader in Electrics & Automation



### Safety Instructions

- For your safety, please read user's manual thoroughly before operating.
- Contact the nearest authorized service facility for examination, repair, or adjustment.
- Please contact qualified service technician when you need maintenance.  
Do not disassemble or repair by yourself!
- Any maintenance and inspection shall be performed by the personnel having expertise concerned.

LS Industrial Systems Co., Ltd.

[www.lsis.biz](http://www.lsis.biz)

### ■ HEAD OFFICE

Yonsei Jaedan Severance Bldg., 84-11, Namdaemunno 5ga,  
Jung-gu, Seoul, 100-753, Korea

Tel. (82-2)2034-4870

Fax. (82-2)2034-4713

### ■ Global Network

- **LS Industrial Systems (Middle East) FZE >> Dubai, U.A.E.**  
Address: P.O.Box-114216, API World Tower, 303B, Sheikh Zayed Road, Dubai, U.A.E.  
Tel: 971-4-332-8289 Fax: 971-4-332-9444 e-mail: hwyim@lsis.biz
- **Dalian LS Industrial Systems Co., Ltd. >> Dalian, China**  
Address: No.15, Liaohexi 3-Road, Economic and Technical Development zone, Dalian 116600, China  
Tel: 86-411-8273-7777 Fax: 86-411-8730-7560 e-mail: lixk@lsis.com.cn
- **LS Industrial Systems (Wuxi) Co., Ltd. >> Wuxi, china**  
Address: 102-A, National High & New Tech Industrial Development Area, Wuxi, Jiangsu,214028, P.R.China  
Tel: 86-510-8534-6666 Fax: 86-510-522-4078 e-mail: xuhg@lsis.com.cn
- **LS-VINA Industrial Systems Co., Ltd. >> Hanoi, Vietnam**  
Address: Nguyen Khe - Dong Anh - Ha Noi - Viet Nam  
Tel: 84-4-882-0222 Fax: 84-4-882-0220 e-mail: sjjo@hn.vnn.vn
- **LS Industrial Systems Tokyo Office >> Tokyo, Japan**  
Address: 16FL, Higashi-Kan, Akasaka Twin Tower 17-22, 2-chome, Akasaka, Minato-ku Tokyo 107-8470, Japan  
Tel: 81-3-3582-9128 Fax: 81-3-3582-2667 e-mail: jschuna@lsis.biz
- **LS Industrial Systems Shanghai Office >> Shanghai, China**  
Address: Room E-G, 12th Floor Huamin Empire Plaza, No.726, West Yan'an Road Shanghai 200050, P.R. China  
Tel: 86-21-5237-9977 (609) Fax: 89-21-5237-7191 e-mail: jinhk@lsis.com.cn
- **LS Industrial Systems Beijing Office >> Beijing, China**  
Address: B-Tower 17FL, Beijing Global Trade Center B/D. No.36, BeiSanHuanDong-Lu, DongCheng-District, Beijing 100013, P.R. China  
Tel: 86-10-5825-6025,7 Fax: 86-10-5825-6026 e-mail: cuixiaorong@lsis.com.cn
- **LS Industrial Systems Guangzhou Office >> Guangzhou, China**  
Address: Room 1403,14F,New Poly Tower,2 Zhongshan Liu Road,Guangzhou, P.R. China  
Tel: 86-20-8326-6764 Fax: 86-20-8326-6287 e-mail: linsz@lsis.biz
- **LS Industrial Systems Chengdu Office >> Chengdu, China**  
Address: 12Floor, Guodong Building, No52 Jindun Road Chengdu, 610041, P.R. China  
Tel: 86-28-8612-9151 Fax: 86-28-8612-9236 e-mail: yanggf@lsis.com.cn
- **LS Industrial Systems Qingdao Office >> Qingdao, China**  
Address: 7B40,Haixin Guangchang Shenye Building B, No.9, Shandong Road Qingdao 26600, P.R. China  
Tel: 86-532-8501-6568 Fax: 86-532-583-3793 e-mail: lirj@lsis.com.cn

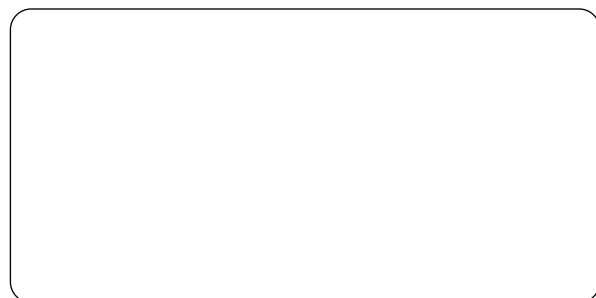

Specifications in this catalog are subject to change without notice due to continuous product development and improvement.