

# RCA

## Lyra Jukebox User's Guide

Changing Entertainment. Again.



### RD2800/RD2820

6th Review • 5/10/2002

# Important Information

## WARNING

To reduce the risk of fire or electric shock, do not expose this product or AC charger to rain or moisture.

## CAUTION

RISK OF ELECTRIC SHOCK DO NOT OPEN

To reduce the risk of electric shock, do not remove cover (or back). No user serviceable parts inside. Refer servicing to qualified service personnel.



This symbol indicates "dangerous voltage" inside the product that presents a risk of electric shock or personal injury.



This symbol indicates important instructions accompanying the product.

To reduce risk of injury, charge only rechargeable batteries recommended by the manufacturer for this product. Other types of batteries may burst causing damage and personal injury.

FCC Regulations state that unauthorized changes or modifications to this equipment may void the user's authority to operate it.

### FEDERAL COMMUNICATIONS COMMISSION INFORMATION

This device complies with Part 15 of the FCC Rules. Operation is subject to the following two conditions: (1) This device may not cause harmful interference, and (2) This device must accept any interference received, including interference that may cause undesired operation.

Note: This equipment has been tested and found to comply with the limits for a Class B digital device, pursuant to part 15 of the FCC rules. These limits are designed to provide reasonable protection against harmful interference in a residential installation. This equipment generates, uses and can radiate radio frequency energy and, if not installed and used in accordance with the instructions, may cause harmful interference to radio communications. However, there is no guarantee that interference will not occur in a particular installation. If this equipment does cause harmful interference to radio or television reception, which can be determined by turning the equipment off or on, the user is encouraged to try to correct the interference by one or more of the following measures:

- Reorient or relocate the receiving antenna.
- Increase the separation between the equipment and the receiver.
- Connect the equipment into an outlet on a circuit different from that to which the receiver is connected.
- Consult the dealer or an experienced Radio/TV technician for help.

This Class B digital apparatus complies with Canadian ICES-003.

### SERVICE

This product should be serviced only by those specially trained in appropriate servicing techniques. For instructions on how to obtain service, refer to the warranty in this guide.

## Product Registration

Please fill out the product registration card and return it immediately. Returning this card allows us to contact you if needed.

## Product Information

Keep your sales receipt for proof of purchase to obtain warranty parts and service and attach it here. Record the serial number and model numbers — both numbers are located on the product.

Model No. \_\_\_\_\_

Serial No. \_\_\_\_\_

Purchase Date \_\_\_\_\_

Place of purchase \_\_\_\_\_

## Chapter 1: Getting Started

<b>Things to consider before you get started...</b>	<b>4</b>
Computer System Requirements	4
Warning	4
Caution	4
Caution While Driving	4
Back up your data	4
<b>What you want to know &amp; where to go</b>	<b>5</b>
<b>Unpack the box and check your parts</b>	<b>6</b>
<b>Overview of buttons and the display</b>	<b>7</b>
<b>Basic Operation</b>	<b>10</b>
Playback operation	11
<b>Operation: Step-by-Step Examples</b>	<b>12</b>
Sort by Artist	13
Sort by Album	14
Sort by Title	15
Sort by Genre	16
Sort by User Playlists	18
Sort by Audio Files	19
Sort by All Files	20
<b>LCD Screen During Playback</b>	<b>21</b>
<b>Setup Information – the details</b>	<b>22</b>
Step 1: Install software in your computer	22
Step 2: Launch the MusicMatch software	25
Set up the Recorder Settings	26
Save CD tracks to play on your PC or in your Lyra Jukebox	28
Download music from the Internet	29
Organizing Your Music	29
Creating Personalized Playlists	30
Step 3: Transfer files to your Lyra Jukebox	31

# Table of Contents

---

## Chapter 2: Lyra Jukebox Menus and Features

Using the Play Modes .....	34
How to access the play modes .....	35
Repeat A-B .....	35
Adjusting DSP Settings .....	36
Personalizing DSP Output (GRAPHIC EQ menu item) .....	37
Setting LCD Preferences (SYSTEM SETTINGS menu) .....	38
Connecting your Lyra Jukebox to your car stereo .....	40
Connecting your Lyra Jukebox to your stereo system .....	41
Portable hard drive capability .....	42

## Chapter 3: Additional Information

Tips and Troubleshooting .....	44
FAQ (Frequently Asked Questions) .....	45
Specifications & System Requirements .....	45
Limited Warranty .....	48
Index .....	51

## Getting Started

### Chapter Overview:

- Things to consider before you get started
- What's where — what you want to know and where to go
- Parts checklist
- Overview of Lyra Jukebox buttons
- Basic operation (how to play music on your Lyra Jukebox)
- Setup details
- How to use MusicMatch to transfer files to your Lyra Jukebox

Changing Entertainment. Again.



## Things to consider before you get started...

### Computer System Requirements

- Pentium 233MHz or higher (Pentium II 300 MHz or higher recommended)
- Windows® 98SE, Me, 2000, or XP
- Internet Explorer 4.0 or higher
- Internet access
- 4 MB free hard disk space for the software plus 1 MB for every minute of CD quality music you store on your hard drive.
- 32MB RAM (64 MB recommended)
- CD-ROM drive capable of digital audio extraction
- USB port
- Installed sound card
- 16-bit color video card

### Warning

Use of this product is for your personal use only. Unauthorized recording or duplication of copyrighted material may infringe upon the rights of third parties and may be contrary to copyright laws.

### Caution

Exposure to direct sunlight or extreme heat (such as inside a parked car) may cause damage or malfunction.

### Caution While Driving

Use of headphones while operating an automobile or moving vehicle is not recommended and is unlawful in some states and areas. Be careful and attentive on the road. Stop operation of the unit if you find it disruptive or distracting while driving.

### Back up your data

As with any device that has a hard drive, you must back up the drive. RCA and Thomson multimedia are not responsible for lost data.

## What you want to know

## Go to page ...



### Parts checklist —

everything that was in the Lyra box

6



### Buttons —

where they are and what they do

7



### Operation — the details

If the information on the printed QuickStart guide wasn't enough, this section gives you a little more detail about the basics of sorting and playing music on your Lyra Jukebox.

10



### Setup information — Step-by-Step instructions

The Lyra QuickStart Guide (the printed foldout that came with your Lyra Jukebox) stepped you through the basics of installing software and downloading files.

If you need more detail, you're in the right place — go to page 22 for step-by-step instructions.

22



### Answers...

to questions and solutions to problems  
— FAQ and Troubleshooting

Chapter 3 (p. 43)

# Getting Started

---

## Unpack the box and check your parts

Your Lyra Jukebox came with everything you need to make music portable — all of the items shown below should have been packed in the box with your Lyra Jukebox.

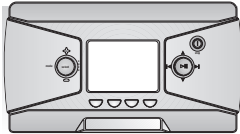

**Lyra Jukebox**



**AC/DC adapter charger**  
part number: 5-4130



**Music Management CD**  
contains the Lyra Jukebox  
Applications & MusicMatch  
Jukebox software



**Headphones**  
part number: 5-4139

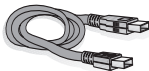

**Mini USB cable**  
Part number: 5-4140  
Plug the small end into your Lyra Jukebox (next to the Headphones jack), and plug the other end into your computer's USB port. Go to page 24 for connection details.

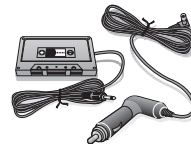

**Car adapter kit**  
Part numbers  
car cord adapter: 5-4129  
cassette adapter: 5-4097  
Go to page 40 for instructions.

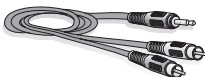

**Line out cable** — connects Lyra Jukebox to your audio system.  
Part number: 5-4138  
For details, go to page 41.

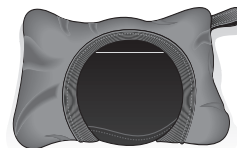

**Carrying case**  
Part number: 5-4141



## Overview of buttons and the display

The following pages explain what each button does — some of the buttons have more than one function depending upon whether you're playing music or not.

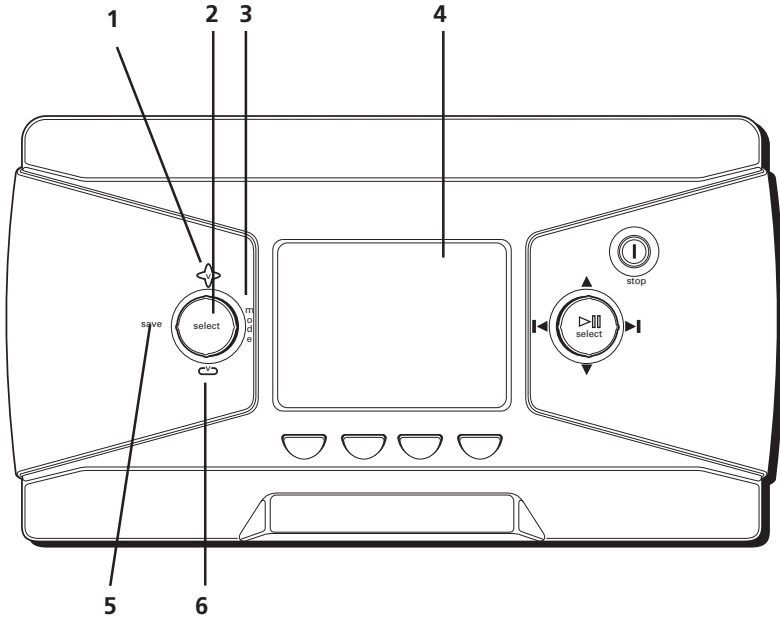

- 1 Volume up** – Increases the volume level.
- 2 SELECT**– When using the Lyra Jukebox menu, selects a highlighted item. When you're creating a User Playlist and you've highlighted a title, SELECT tags a song to be included in a User Playlist.
- 3 MODE** – Accesses the mode menu where you can choose the following playback modes: *NORMAL*, *REPEAT*, *REPEAT 1*, *REPEAT ALL*, *SHUFFLE*, and *REPEAT ALL SHUFFLE*. For details about playback modes, go to page 34.
- 4 LCD (Liquid Crystal Display)** – This is where the Lyra's user interface appears (go to page 21 for an explanation of the items that appear on the LCD during playback).
- 5 SAVE** – Saves a User Playlist that consists of the songs you've tagged. You can create a new playlist or add songs to an existing User Playlist.
- 6 Volume down** – Decreases the volume level.

**continued on next page**

# Getting Started

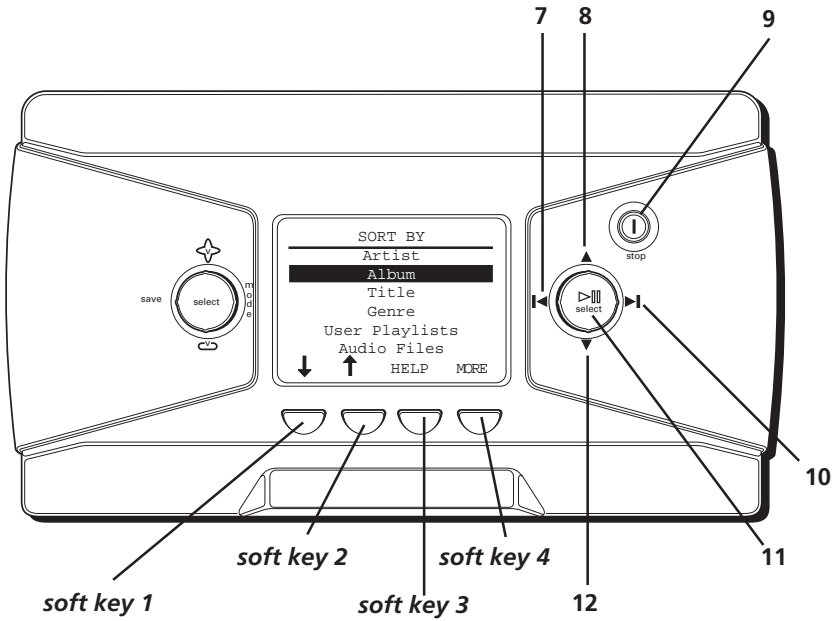

- 7 **Left arrow button** – When you're playing music, press and release to skip back to the previous song (to scan backwards in the song that's playing, press and hold). When you're using the Lyra Jukebox menu, moves highlight left.
- 8 **Up arrow button** – When using the Lyra Jukebox menu, moves the highlight up.
- 9 **STOP/power** – Turns on your Lyra Jukebox. To turn off the Lyra Jukebox, press and hold the stop/power button. When you're playing music, stops playback.
- 10 **Right arrow button** – When you're playing music, press and release to skip forward to the next song (to scan forwards in the current song, press and hold). When you're using the Lyra Jukebox menu, moves highlight right.
- 11 **PLAY/PAUSE** – Press to play. During playback, press to pause music.
- 12 **Down arrow button** – When using the Lyra Jukebox menu, moves the highlight down.

**Soft keys 1, 2, 3, and 4** – These buttons provide quick access to the menu items that appear at the bottom of the screen (the LCD). You'll notice the items on the screen change based on the features you're using — these are called adaptive navigation keys.

In the illustration above, if you pressed soft key 1 the highlight would move down (*Title* would be highlighted); press soft key 2 to move up (*Artist* would be highlighted); soft key 3 (*HELP*) takes you to the Lyra Jukebox's on-screen help information; soft key 4 (*MORE*) takes you to additional menu items.

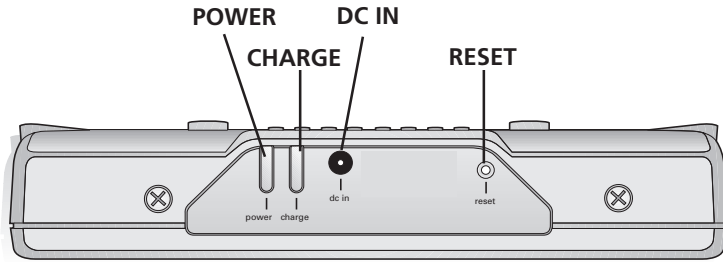

## **Back view**

**POWER indicator** – Lights when the Lyra Jukebox is on (receiving power from the DC IN jack).

**CHARGE indicator** – Lights when the battery is charging and when the Lyra Jukebox is receiving power from the DC IN jack. Flashes when there is an error.

**DC IN jack** – Plug in the AC power adapter here. When you plug in the AC adapter, the battery inside of the Lyra Jukebox automatically starts charging.

**RESET button** – If your Lyra Jukebox appears to be locked up, press the RESET button (the memory will be cleared and settings will return to the factory defaults).

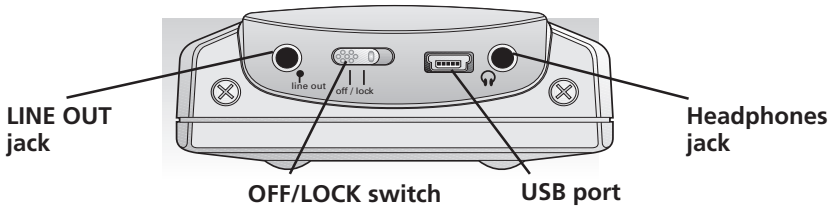

## **Right side view**

**LINE OUT** – Attach the line out cable here when you're connecting the Lyra Jukebox to an audio system.

**OFF/LOCK switch** – To make the buttons inactive, slide the switch to the lock position (the  key icon appears in the display to remind you that you've locked the buttons). Slide the switch to the OFF position for normal operation (button lock off).

**USB port** – Attach the small end (Type mini-B) of the mini-USB cable here. Attach the large end (Type A) to your computer.

**Headphones jack** – Insert the headphones plug here.

## Basic Operation

The information in this section presumes you've successfully transferred files to your Lyra Jukebox, and you're ready to play some music.

If you need specific set-up information (downloading music, transferring files, installing software), go to page 22.

If you want more detailed information about the Lyra Jukebox's features, go to page 34.

Understanding how to navigate through the Lyra Jukebox's menu system, combined with how the buttons operate, will give you the information you need for basic functionality.

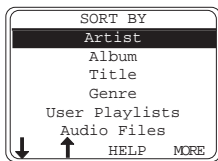

The *SORT BY* menu is the main menu. The navigation scheme is the same no matter how many menus you access:

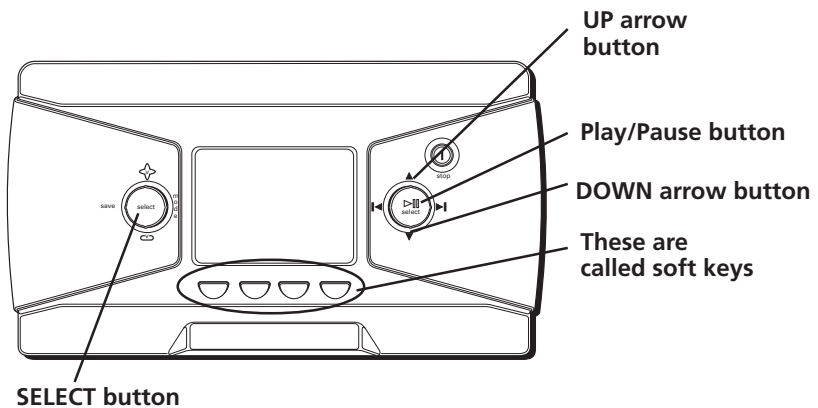

1. Press the arrow up or down buttons (▲ or ▼) to highlight different items on the screen.
2. To see the submenu, press the SELECT button.
3. Use the soft keys (if necessary) to highlight the song title you want to hear.

*Note: If you need more explanation, go to page 11.*

4. Once the song you want to play is on the screen, press ►|| (play/pause) to play the track. Press it again to pause playback.

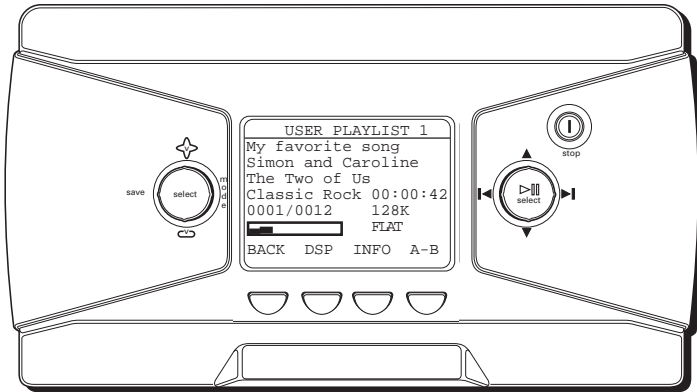

## Playback operation

- To scan backwards in the track that's playing, press and hold ◀ (the left arrow button).
- To scan forwards in the track that's playing, press and hold ▶ (the right arrow button).
- To go to the next track, press and release ▶ (the right arrow button).
- To go to the previous track, press and release ◀ (the left arrow button).
- To stop playback, press ⏹ (the STOP button). The display returns to the previous menu location.
- To turn up the volume, press ⬆ (the volume up button). The volume display bar updates to show the increase in volume level.
- To turn down the volume, press ⬇ (the volume down button). The volume display bar updates to show the decrease in volume level.
- To change the play mode setting, press the MODE button (for details about the different play modes go to page 34)

## Operation: Step-by-Step Examples

The following example illustrates (with more detail than the previous information) how you find the song you want to play.

1. These instructions presume you've already done the following:
  - Installed the MusicMatch Jukebox software and the Lyra MP3/Personal Jukebox profiler application (go to page 22 for detailed instructions).
  - Transferred music from your computer to the Lyra Jukebox (page 31 has detailed instructions) and profiled the contents of the Lyra Jukebox through MusicMatch Jukebox or the Profiler software.

*Note: The music you're transferring could be from a CD you put in your computer, the internet, or music you already had loaded onto your computer.*

2. If you haven't already unplugged the Lyra Jukebox from your computer, disconnect the USB cable from the Lyra Jukebox.

*Note: If you're running Windows 2000, XP, or Me, you must stop the device before unplugging it. Click the  icon (the Unplug or Eject hardware icon) from the system tray and select the USB Mass Storage device for the drive letter associated with the Lyra Jukebox, and click STOP. See the Windows Help for details about the Unplug or Eject Hardware topic.*

3. If you've fully charged the battery (the Lyra Jukebox needs to be plugged in for about 4 hours before the battery is fully charged), disconnect the AC adapter from the outlet and then from your Lyra Jukebox.

*Note: If the battery isn't fully charged, keep the Lyra Jukebox plugged in while you listen to the music you've transferred from your computer.*

4. Connect the headphones to your Lyra Jukebox (insert the end of the headphones connector into the phones jack on the side of the Lyra).
5. If your Lyra Jukebox isn't already on, turn it on (press and hold the  button for two seconds). The RCA Lyra logo flashes on the screen, and then the main menu appears the *SORT BY* menu.

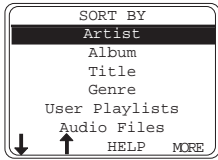

## Sort by Artist

1. Highlight *Artist* (press the up or down arrow button).

*Note: You can also highlight items on the screen by pressing the soft keys when they have arrows above them. In this example soft key 1 would move the highlight down and soft key 2 would move the highlight up.*

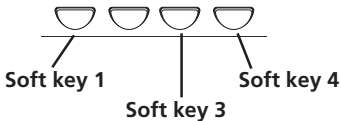
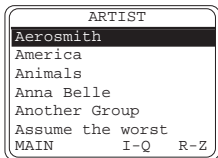

2. Press the SELECT button (the *ARTIST* menu appears with the artists stored on your Lyra Jukebox listed in alphabetical order).

- To see the list of artists whose names start with I - Q, press soft key 3.
- To see artists from R - Z, press soft key 4.
- To return to the *SORT BY* menu, press soft key 1 (labeled *MAIN*).

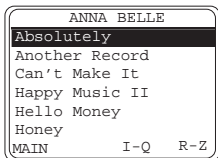

3. To see the albums for the artist highlighted, press SELECT (the album titles for that artist appear in alphabetical order).

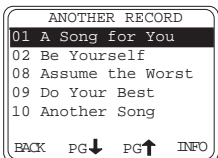

4. To see the songs on the album you've highlighted, press SELECT (the songs for that album appear).

*The SELECT button may be used alternately to select and de-select titles that you want to save in the programmable playlist.*

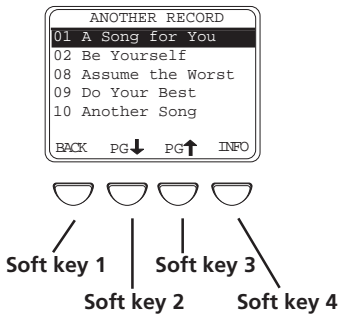

Highlight the desired song.

- To play the song, press  (the play/pause button).
- To go to the previous menu, press soft key 1 (*BACK*).
- To scroll down the list 5 songs at a time, press soft key 2 (*PG down*).
- To scroll up the list 5 songs at a time, press soft key 3 (*PG up*).
- To get more info about the song, press soft key 4 (*INFO*).

*Note: The information provided in the INFO screen depends upon the ID3 tags that have been set up for the song.*

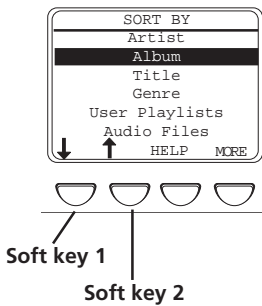

## Sort by Album

1. Highlight *Album* (press the up or down arrow button, or the first or second soft key).

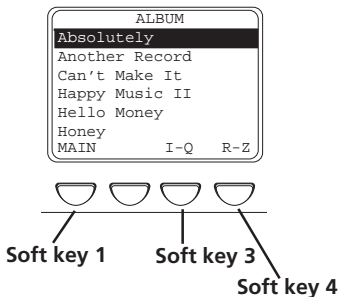

2. Press SELECT (the *ALBUM* menu appears with the titles of the albums stored on your Lyra Jukebox listed in alphabetical order).
  - To see the list of albums with names starting with I - Q, press soft key 3.
  - To see albums from R - Z, press soft key 4.
  - To return to the *SORT BY* menu, press soft key 1 (labeled *MAIN*).



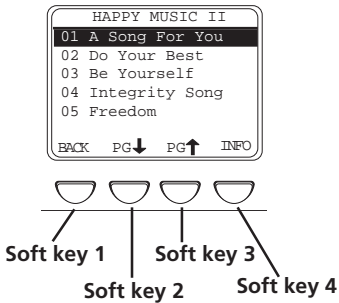

3. To see the songs for the album highlighted, press SELECT (the songs on that album appear).

*The SELECT button may be used alternately to select and de-select titles that you want to save in the programmable playlist.*

4. Highlight the song you want to play.
  - To play the song, press ▷||| (the play/pause button).
  - To go to the previous menu, press soft key 1 (BACK).
  - To scroll down the list 5 songs at a time, press soft key 2 (PG down).
  - To scroll up the list 5 songs at a time, press soft key 3 (PG up).
  - To get more info about the song, press soft key 4 (INFO).

*Note: The information provided in the INFO screen depends upon the ID3 tags that have been set up for the song.*

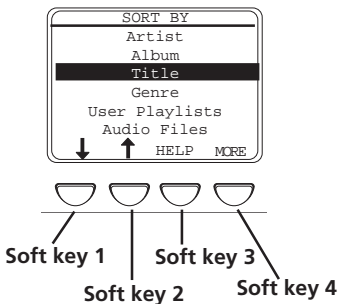

## Sort by Title

1. Highlight *Title* (press the up or down arrow buttons, or the first or second soft key).
2. Press SELECT (the *TITLE* menu appears that lists all of the song titles in alphabetical order that are stored on your Lyra Jukebox).
  - To play the first song, press ▷||| (the play/pause button).
  - To highlight a different song on the list, press the up or down arrow button.
  - To see the titles with names that start with I - Q, press soft key 3.

# Getting Started

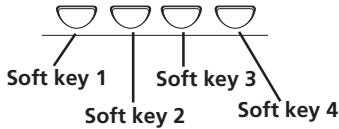
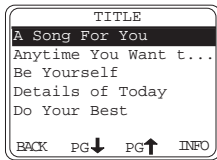

- To see the titles from R - Z, press soft key 4.
- To return to the *SORT BY* menu, press soft key 1 (labeled *MAIN*).
- To get more info about the song, press soft key 4 (*INFO*).

*Note: The information provided in the INFO screen depends upon the ID tags that have been set up for the song.*

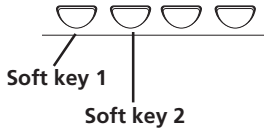
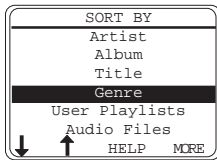

## Sort by Genre

1. Highlight *Genre* (press the up or down arrow button, or the first or second soft key).

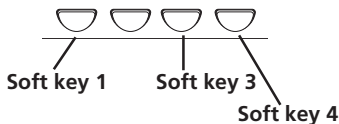
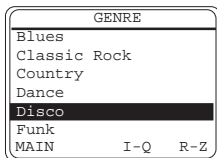

2. Press SELECT (the *GENRE* menu appears).
  - To highlight different genres, press the up or down arrow button.
  - To see the list of genres starting with I - Q, press soft key 3.
  - To see the list of genres starting with R - Z, press soft key 4.
  - To return to the *SORT BY* menu, press soft key 1 (labeled *MAIN*).

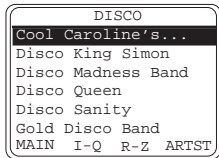

Soft key 4

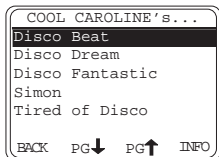

Soft key 1

Soft key 2

Soft key 3

Soft key 4

- To see a list of artists for the genre you've highlighted, press SELECT (a list of artists for that genre appears). To jump to the complete Artist listing, press soft key 4 (*ARTST*).

- To see the songs for the artist that you've highlighted within this genre, press SELECT (the songs appear in alphabetical order).

*The SELECT button may be used alternately to select and de-select titles that you want to save in the programmable playlist.*

- Highlight the song you want to play.
  - To play the song, press  (the play/pause button).
  - To go to the previous menu, press soft key 1 (*BACK*).
  - To scroll down the list 5 songs at a time, press soft key 2 (*PG down*).
  - To scroll up the list 5 songs at a time, press soft key 3 (*PG up*).
  - To get more info about the song, press soft key 4 (*INFO*).

*Note: The information provided in the INFO screen depends upon the ID3 tags that have been set up for the song.*

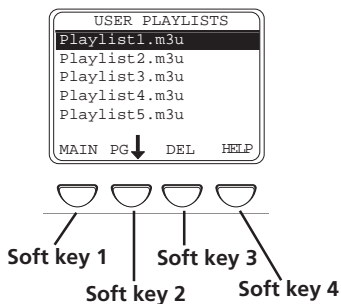
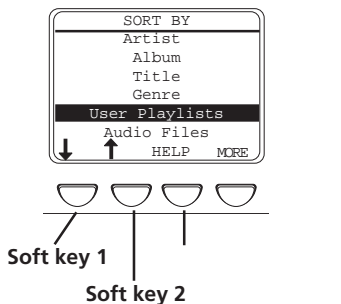

---

## How to Create User Playlists

If you need information about Creating User Playlists, go to page 30.

---

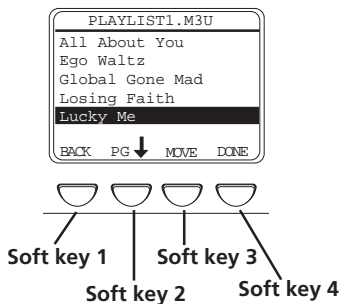

## Sort by User Playlists

1. Highlight *User Playlists* (press the up or down arrow button, or soft key 1 or soft key 2).
  - To see contents of the playlist that's highlighted, press SELECT (skip to step 3 for more information).
  - To play the first song in the User Playlist that is highlighted, press (the play/pause button).
  - To go back to the *SORT BY* menu, press soft key 1 (*MAIN*).
  - To scroll down to the next 5 User Playlists, press soft key 2 (*PG down*).
  - To delete the playlist that's highlighted, press soft key 3 (*DEL*). A screen appears asking you to confirm that you want to delete the playlist.
  - For on-screen help, press soft key 4 (*HELP*).
3. When the individual songs of the playlist are on the screen:
  - Play the song that you've highlighted, by pressing (play/pause button).
  - Scroll through the songs in the playlist by pressing the up or down arrow button.To scroll a page at a time, press soft key 2 (*PG down*).

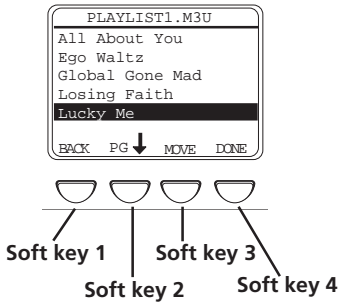

- Delete a song from the playlist by DEL (delete) — soft key 3 — (a screen appears asking you to confirm that you want to delete this item).
- Rearrange the order of the songs in the playlist by pressing soft key 4 (*MOVE*) — go to instructions below for more information.

## How to rearrange the order of the songs

1. When the individual songs of the playlist are on the screen, press the up or down arrow button to highlight a song you want move and press soft key 4 (*MOVE*) – explained in previous section.

- To move the song down one position, press soft key 2 (*MOVE* down).
- To move the song up one position, press soft key 3 (*MOVE* up).

*Note: If you want to keep the playlist order the same, just press soft key 4 (CANCEL) — the previous screen appears and the original order of this playlist is restored.*

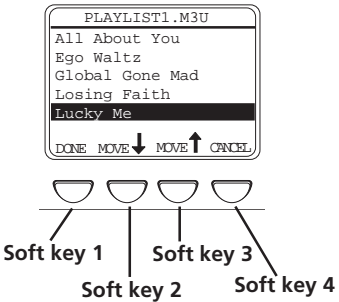

2. When you have the songs in the playlist arranged in the order you want, press soft key 1 (*DONE*).

## Sort by Audio Files

1. Highlight *Audio Files* (press the up or down arrow button, or the first or second soft key).
2. Press SELECT (the *AUDIO FILES* menu appears). It lists all supported audio files that are stored on your Lyra Jukebox by file name in alphabetical order.
  - To play the first song, press ▷||| (the play/pause button).
  - To highlight a different song on the list, press the up or down arrow button.
  - To see the audio files with file names that start with I - Q, press soft key 3.
  - To see the audio files from R - Z, press soft key 4.
  - To return to the *SORT BY* menu, press soft key 1 (labeled *MAIN*).

**continued on next page**

- To get more info about the song, press soft key 4 (*INFO*).

*Note: The information provided in the INFO screen depends upon the ID3 tags that have been set up for the song.*

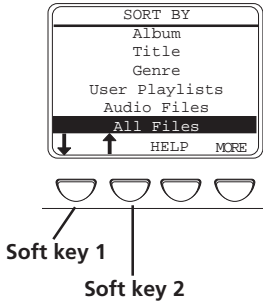

## Sort by All Files

Since your Lyra Jukebox has a hard drive with 10 Gigabytes of storage space, it can be used to store and transport files . To see all of the files that are stored on your Lyra Jukebox:

1. Highlight *All Files* (press the up or down arrow buttons, or the first or second soft key).

*Note: the All Files category doesn't appear on initial Sort By menu (it's below Audio Files).*

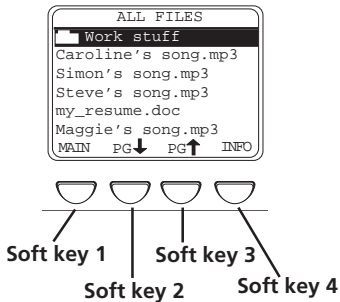

2. Press SELECT (the *ALL FILES* menu appears). Folders are listed first and individual files are listed next.

*Note: The folders and files are sorted in the order they were transferred to the Lyra Jukebox (the folder you transferred most recently appears last in the list of folders and the file you transferred most recently would be the last on the list since file names follow folder names).*

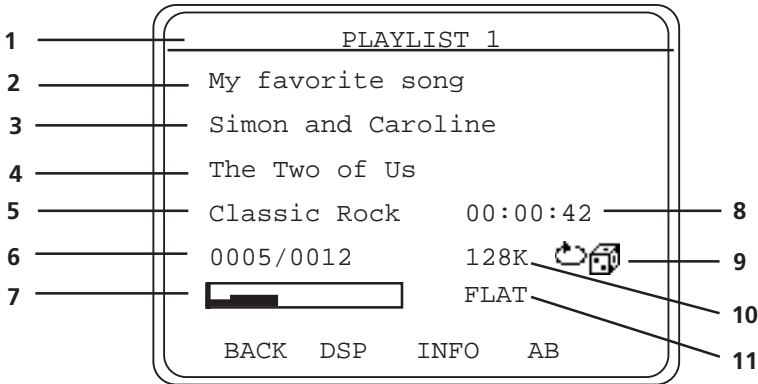

- To see the folders/files stored in a folder, highlight the folder and press SELECT.
- To scroll down 5 files/folders at a time, press soft key 2 (*PG* down).
- To scroll up 5 files/folders at a time, press soft key 3 (*PG* up).
- To see information about the file, press soft key 4 (*INFO*).
- To return to the main menu (*SORT BY* menu), press soft key 1 (*MAIN*).

## LCD Screen During Playback



This picture illustrates what you'll see on your Lyra Jukebox LCD screen when you're playing music.

### LCD Screen during Playback

- 1 Playlist name, or path of file**
- 2 Song title or file name** – Based on ID3 tag information, if it is available. If no ID3 tag information is available, it will be blank.
- 3 Artist name** – Based on ID3 tag information, if it is available. If no ID3 tag information is available, it will be blank.
- 4 Album title** – Based on ID3 tag information, if it is available. If no ID3 tag information is available, it will be blank.
- 5 Genre** – Based on ID3 tag information, if it is available. If no ID3 tag information is available, it will be blank.
- 6 Current item** – Current track being played/out of total files being played (varies depending on the playback mode setting).
- 7 Volume level indicator** – There are 50 steps in the volume control. Press the volume up/down buttons to change the volume.
- 8 Elapsed time of track or pause indicator**– When you're playing music, the amount of time that the track has played appears; when you pause playback, the pause icon appears.
- 9 Playback mode indicator**  – Displays current playback mode (Normal, Repeat, Shuffle, etc.). The icon that appears in the picture above is the Repeat Shuffle icon (.
- 10 Bit-rate format (Recording Quality Level)** – The setting you chose in the *Recorder* menu (tab) that dictates the bit-rate value that's used when you convert (record) the song using the MusicMatch Jukebox software. Go to page 27 for more information.
- 11 DSP setting (FLAT)** – The DSP (Digital Signal Processing) setting (Flat, Rock, Bass, etc.). For more information about DSP settings, go to page 36.

## Setup Information – the details

### Install software in your computer

The Music Management CD that came with your Lyra Jukebox contains all of the necessary software components you need to make your Lyra Jukebox work properly. These components do the following:

- enable you to transfer files from your computer to your Lyra Jukebox
- profile and sort the contents, update the system and help files
- use the MusicMatch Jukebox software to organize your music collection and transfer the music to your Lyra Jukebox
- install the User's Guide and documentation for the Lyra Jukebox

The MusicMatch Jukebox™ software compresses audio files (from music CDs) to the MP3 format so you can play them on your Lyra Jukebox. The MusicMatch software also enables you to download files from the internet that are already compressed and then transfer those files to your Lyra Jukebox (or play the music on your computer).

1. Turn on your computer and place the Music Management CD that came with your Lyra Jukebox into your computer.

**IMPORTANT:** Don't connect the USB cable to the PC or Lyra Jukebox before or during the driver installation.

*If you're running Windows 2000, XP, or Me, no additional drivers are required. If you're running Windows 98SE, you **must** install the device drivers from the CD-ROM in order for the Lyra Jukebox to function properly.*

2. If the setup screen does not appear, double click *My Computer*, double click your CD-ROM drive icon, and double click *Quickstart.exe*. You can also click, *Run*, then type D:\QuickStart.exe (where D is the letter of your CD-ROM drive).

The Lyra Jukebox and MusicMatch Jukebox quick start program runs.



3. Select the *Install Lyra MP3 Jukebox Applications* option to run the Lyra Jukebox System Applications setup program.
4. Click *Yes* to agree to the License Agreement.
5. Click the software components you're going to install (a list follows):



*Note: This book only discusses the MusicMatch features that directly apply to your Lyra Jukebox. For additional information about MusicMatch Jukebox features such as MusicMatch radio MX, creating Music CDs, Music Library features, go to:*

*MusicMatch tutorial on the Music Management CD*

*Getting Started tips*

*On-line help ([www.musicmatch.com](http://www.musicmatch.com))*

*Help that's available within the software*



- **The System Profiler Application** component must be installed in order for the Lyra Jukebox to function properly. This application allows you to sort and profile the music that you've transferred to your Lyra Jukebox, and update the system files and the help files that are stored on the Lyra Jukebox.
- **Universal Serial Bus Drivers (Windows 98SE only)** must be installed in order for the Lyra Jukebox to be recognized by your computer's operating system and appear as a drive letter.
- **User's Guide and Documentation** installs all necessary Lyra Jukebox documentation and help files.

6. Click *Next* to select the destination location of the installed files.
7. Click *Next* to install all necessary files.
8. Click *Finish* to complete installation and return to the Quickstart program.

*Note: If you're running Windows 98SE, rebooting your computer will be required.*

9. Click *Install MusicMatch Jukebox Software* to run the MusicMatch setup program.

*Note: It is recommended to uninstall any previous installations of the MusicMatch Jukebox software before proceeding.*

*After the uninstall process has been completed, delete the C:\Program Files\MusicMatch folder from Windows and where C:\Program Files is the path where the software was installed.*

10. Click *Next* to dismiss the *Welcome Screen* (the *License Agreement* appears).
11. After you've read the license agreement, click *Yes* to accept (to continue, you must click *Yes*), or *No* to decline. If you click *Yes*, the *User Registration Information* screen appears.

# Getting Started

---

12. Enter your name, e-mail address, postal code, country, year of birth, and sex (male or female).

*Note: You must enter an e-mail address to proceed. If you don't have an e-mail address, enter yourname@home.com*

13. Click *Next* (the *Personalize Music Recommendation* screen appears). Read the screen to determine if you want to use this feature or not — you can always change the setting later. Select *Yes* or *No*.
14. Click *Next* (the *Installation Options* dialog screen appears). Select *Express Setup* and click *Next* to continue (the installation starts).
15. After the installation is complete, click *Finish*.
16. If necessary, close the main setup screen.
17. Some computers might request that you reboot your computer (a dialog box will appear on the computer screen if this is necessary).

*Note: As with any device that has a hard drive, you must back up the drive. RCA and Thomson are not responsible for lost data.*

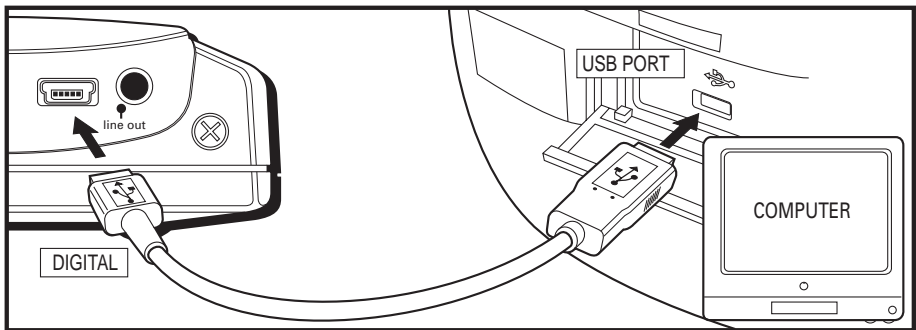

## Transfer the files to your Lyra Jukebox via Windows Explorer (Drag and Drop)

1. Connect the Lyra Jukebox to your computer with the mini USB cable provided. The Lyra Jukebox will appear as a Removable Disk drive letter.

*Note: It might take several seconds for the device (the Lyra Jukebox) to be detected, especially in Windows 2000. Click Refresh in My Computer or Explorer to make sure the device has been detected.*

2. From Explorer, highlight all of the files/folders you want to transfer to your Lyra Jukebox and drag them to the drive letter that is associated with it.



*Profiler application icon found in your computer's system tray.*

---

### Tip: Multiple Devices

*If more than one Lyra Jukebox device is connected to the system, a submenu appears listing the drive letters of the Lyra Jukebox devices. Select the desired drive letter to Profile and Update.*

---

**Note: As with any device that has a hard drive, you must back up the drive. RCA and Thomson are not responsible for lost data.**

---

3. Select the *Profile Lyra MP3/Personal Jukebox Device* menu from the **Lyra** icon (the Lyra Jukebox profiler application icon that's in your PC's system tray, at the bottom right of your computer screen). The Lyra Jukebox/Personal Jukebox Profiler Application appears.
4. The application will profile and sort all supported audio files so you can sort them and play them properly. Press *Done* to dismiss the application when profiling is finished.
5. Select the *Update Lyra MP3/Personal Jukebox System files* menu item to update all system files and help files.

*Caution: Don't unplug the USB cable until all data are transferred to the Lyra Jukebox.*

*If you're running Windows 2000, XP, or Me, you must stop the device before unplugging it. Click the  icon (the Unplug or Eject hardware icon) from the system tray and select the USB Mass Storage device for the drive letter associated with the Lyra Jukebox, and click STOP. See the Windows Help for details about the Unplug or Eject Hardware topic.*

## Launch the MusicMatch software

The MusicMatch software converts audio files to the MP3 format so you can play them on your Lyra Jukebox. This section describes some basic MusicMatch features and explains how to convert music to the MP3 format. For more information about MusicMatch, see the tutorial or go to [www.musicmatch.com](http://www.musicmatch.com).



*The MusicMatch icon found in your computer's system tray.*

1. Remove the Music Management CD from your computer.
2. Start the MusicMatch Jukebox software (click on the MusicMatch icon in your system tray or on your desktop).

**continued on next page**

# Getting Started



3. The first time you launch MusicMatch, a *Getting Started* screen appears providing information about MusicMatch and the software.
4. Detailed information, Getting Started tips, and troubleshooting are available through the Help menu and the MusicMatch internet site (accessed from the Help and Site menus). We recommend you familiarize yourself with the MusicMatch Welcome Tips and view the On-line FAQs before using and recording files.

*Note: Logging onto the internet while using MusicMatch Jukebox takes advantage of all its features.*

5. Choose *Settings* under the *Options* menu to customize the MusicMatch Jukebox functionality.

*Note: You can access the Options menu at almost any time by pressing the right mouse button.*

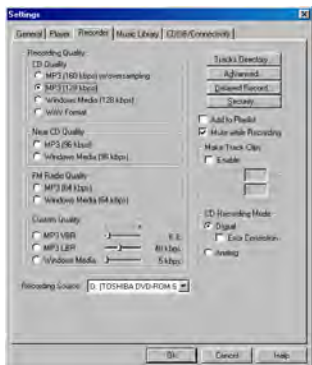

## Set up the Recorder Settings

Click the *Recorder* tab to display the *Recorder* settings.

*Note: Recorder settings are used when you're using the MusicMatch software to convert (record) music files to the compressed format that your Lyra Jukebox can play.*

*Note: This book only discusses the MusicMatch features that directly apply to your Lyra Jukebox. For additional information about MusicMatch Jukebox features, go to [www.musicmatch.com](http://www.musicmatch.com)*

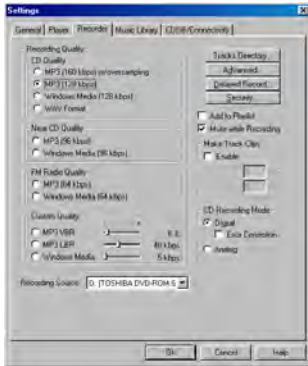

## Select the Recording Quality level – **CD Quality MP3 (128Kbps)** is recommended

- MP3 audio is MPEG Layer-3 Audio available at various encoding bit rates. The highest bit rate has the best quality sound, but uses the most disk space.
- WAV audio is unencoded music that is not compressed. This format has the best quality sound but requires the largest file size, as much as 650MB per CD. WAV audio files are much larger than MP3 audio files.
- Windows Media™ audio is a compression format created by Microsoft. This audio format incorporates digital rights management.

### Notes:

*Custom Quality settings are for advanced users only.*

*Lyra Jukebox currently only supports MP3 audio format.*

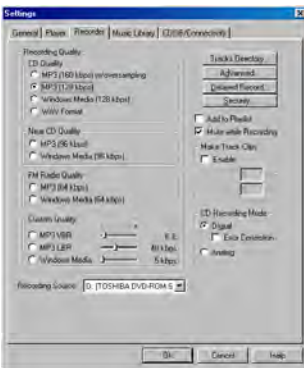

## Select a CD Recording Mode

1. Check *Digital and Error Correction* for the best results. Error checking and correction will be performed while you are recording (if your computer doesn't support this setting, you will get a message prompting you to change to *Analog*).

*Note: Choosing Digital and Error Correction will slow down your recording speed.*

2. Check *Analog* if your CD-ROM drive doesn't support digital audio extraction.
3. Select a default *Recording Source*. If you have more than one recording source, select the source you record from the most.
4. *Mute while Recording* (this is not recommended as it will decrease the recording speed). This feature allows you to mute the audio while it is being recorded. Uncheck this box to hear the audio as it is recorded.

# Getting Started

## Save CD tracks to play on your PC or in your Lyra Jukebox

1. Insert a CD into your CD-ROM drive. If you are connected to the internet, MusicMatch Jukebox will retrieve information about the CD in the CD-ROM drive.





*Note: If you are on a LAN system and the titling feature does not work, contact your administrator.*

2. If you're able to connect to the internet, make sure the *Enable CDDB CD* lookup service is selected on the *CDDB Preferences* page. Choose *CDDB Preferences* from *Settings* in the *Options* menu. (The information from the internet appears).

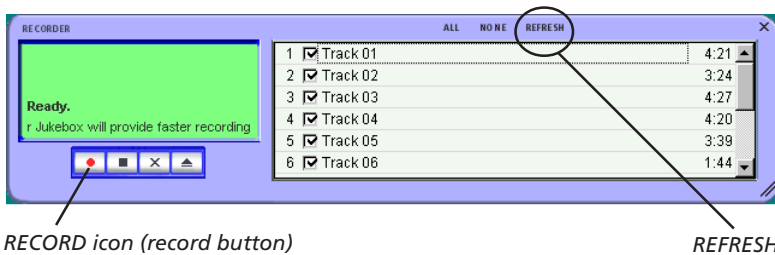
**Notes:** *If the information cannot be retrieved from the Internet, enter it manually. You can enter information or edit existing information by clicking in the desired box and typing the information.*

*If the information is not entered before recording, default song names and information will be used.*



3. If the *RECORDER* window (shown above) isn't open, press the  icon (the record button). If the songs aren't listed, press *REFRESH*.
4. Select the tracks you want to record (recording the tracks enables the MusicMatch software to convert the songs to the selected audio format that the Lyra Jukebox plays).
  - To start recording, click  (record).
  - To stop recording the current track, click  (stop).
  - To cancel the entire recording session for all selected tracks, click  (cancel).
  - To eject the CD, click  (eject).
  - To select all songs, click *ALL*.
  - To deselect all songs, click *NONE*.
  - To refresh the track title information or to attempt detection again, click *REFRESH*.
5. After recording is completed, the songs will be stored in the Music Library.

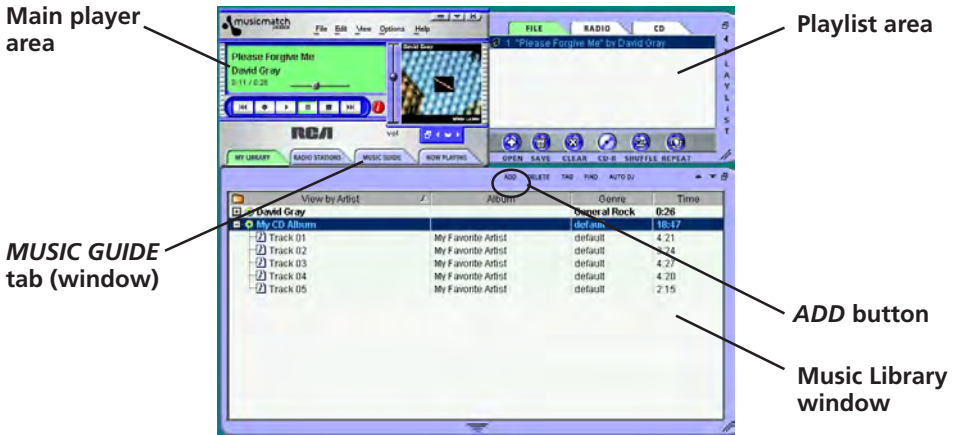

## Download music from the Internet

1. Make sure you're connected to the internet.
2. Click *MUSIC GUIDE* to connect to the MusicMatch download site.

*Note: You can also select Show MusicMatch Guide from View in the Options menu to display this window. If you have not established an Internet connection, MusicMatch Jukebox will attempt but fail to connect.*

Music you download from the *MUSIC GUIDE* window will automatically be placed in the Music Library.

You can download files using your regular browser. Be sure to import (and/or move) them into MusicMatch Jukebox.

You can also select *Show MusicMatch Radio* from *View* in the *Options* menu to display this window.

## Organizing Your Music

The Music Library now displays your selections. To sort by categories click on the folder icon (sort/view button) in the Music Library window.

## Adding Tracks

1. Click *ADD* button from the Music Library window (the *Add Tracks to Music Library* screen appears).
2. Select the folder location on your system that you would like to import music from and select OK (all supported music tracks will be imported into the Music Library).





## Step 3: Transfer audio files to your Lyra Jukebox

Once you've created the current playlist that contains all of the songs you want to transfer to your Lyra Jukebox, follow the steps below:

1. If your Lyra Jukebox isn't already connected to your computer, use the mini-USB cable that came with your LyraJukebox to connect the LyraJukebox to the computer. Go to page 24 for instructions.

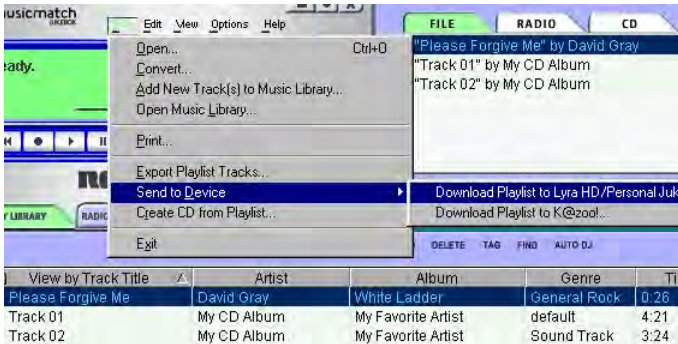

2. From the *File* menu, select the *Send to Device* option, and select *Download to Lyra MP3/Personal Jukebox* item (the Download dialog appears).

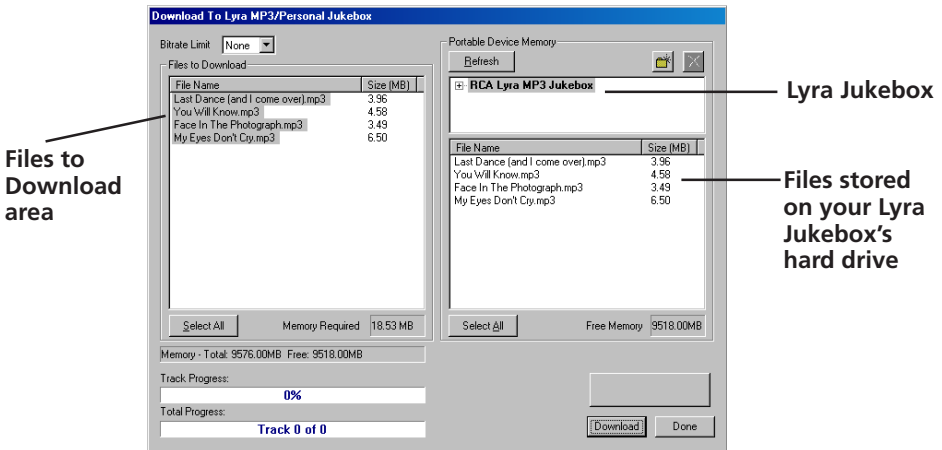

3. Highlight the tracks you want to download (transfer) to your Lyra Jukebox in the *Files To Download* area.

**continued on next page**

# Getting Started

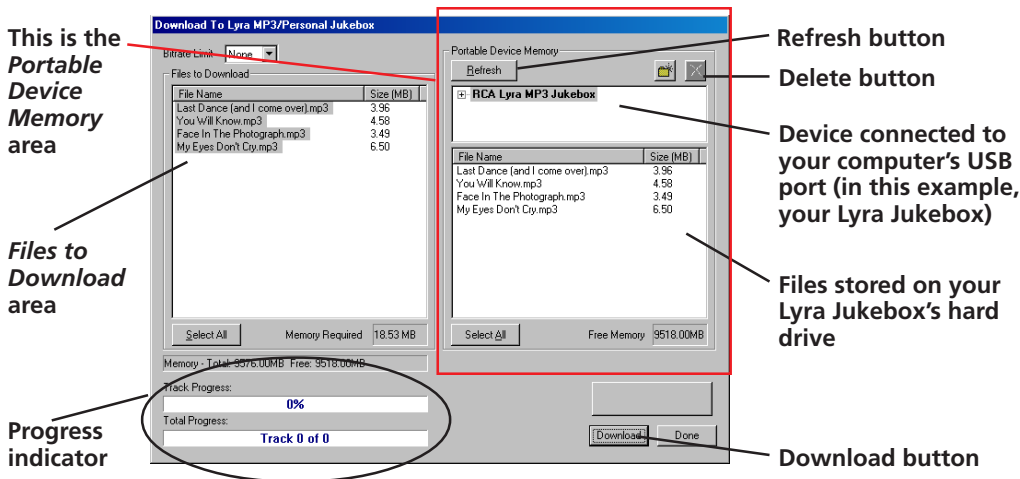

4. After you have selected all of the music you want to transfer to your Lyra Jukebox, click the *Download* button on the bottom of the screen.

**IMPORTANT:** If your Lyra Jukebox doesn't appear in the *Portable Device Memory* area, click the *REFRESH* button.

During transfer a progress indicator appears in the *Download to Lyra MP3/Personal Jukebox* screen (shown above), and *Transfer in progress* appears in the Lyra Jukebox's LCD.

When the transfer is finished, the Lyra MP3/Personal Jukebox Profiler application automatically runs so it can sort/profile the newly transferred files.

**Caution:** Make sure all data are transferred to the Lyra Jukebox before unplugging the USB cable.

If you're running Windows 2000, XP, or Me, you must stop the device before unplugging it. Click the  icon (the *Unplug* or *Eject* hardware icon) from the system tray and select the USB Mass Storage device for the drive letter associated with the Lyra Jukebox, and click *STOP*. See the Windows Help for details about the *Unplug* or *Eject Hardware* topic.

## Deleting Files

To delete files from the Lyra Jukebox:

1. Select the Jukebox device item from the *Portable Device Memory* area.
2. Select the files to be deleted.
3. Press the *DELETE* button on the screen.

**Note:** For information about the drag and drop method for transferring files, go to page 24.

# Features & Menus

## Chapter Overview:

- Play modes (Repeat, A-B Repeat, Shuffle, etc.)
- Adjusting DSP settings (flat, rock, jazz, etc.)
- Setting LCD preferences (contrast, backlight, etc)
- Connecting your Lyra Jukebox to your car stereo
- Connecting your Lyra Jukebox to your stereo system
- Portable hard drive capability

Changing Entertainment. Again.



## Using the Play Modes

Once you have music transferred to your Lyra Jukebox you can use the **MODE** button to access different play modes that are used in other audio equipment: Shuffle, Repeat 1, Repeat, Repeat All, Repeat Shuffle.

*Note: The REPEAT A-B play mode can only be accessed when you're playing music, go to page 35 for more information.*

You can choose a play mode before you start playing a song (via the **MODE SETTINGS** menu appears) or you can cycle through the play modes during playback by pressing the **MODE** button (the play mode icons appear in the LCD).

**No icon in LCD**

**Normal:** Plays the songs in the order they appear (no icon appears in the LCD).



**Repeat 1:** Plays the current song repeatedly.



**Repeat:** Plays a series of songs repeatedly, based on option you selected in the *SORT BY* menu (main menu) when you started playback.



**Repeat All:** Plays all songs repeatedly, based on option you selected in the *SORT BY* menu (main menu) when you started playback.



**Shuffle:** Plays the songs in random order, based on option you selected in the *SORT BY* menu (main menu) when you started playback.



**Repeat Shuffle:** Plays selected songs in random order, repeatedly based on option you selected in the *SORT BY* menu (main menu) when you started playback.



**Repeat All Shuffle:** Continually plays all songs in random order based on option you selected in the *SORT BY* menu (main menu) when you started playback.

## How to access the play modes

**During navigation mode (you've turned on your Lyra Jukebox, but you are using the menu system and not playing music)**

1. Press the MODE button (the *MODE SETTINGS* menu appears).
2. Press the arrow down button (or soft key 2) or the arrow up button (soft key 3) until the play mode you want to use is highlighted.
3. Press *BACK* (soft key 1) to return to the previous screen and the mode selection will be updated to reflect the choice you made in step 2.
4. To change the current play mode, just press the MODE button during playback.

### During playback



1. Press the MODE button to cycle through the choices (the play mode icons are updated on the LCD).

*Note: No icon appears in the LCD for the Normal playback mode.*

## Repeat A-B

Repeat A-B enables you to mark a starting point and an ending point during playback — the Repeat A-B playback mode will only play the segment that you marked. When the end of the segment (the B point) is reached during playback, the Lyra will start playback again from the beginning (the A point).

*Note: Unlike other playback modes, Repeat A-B is only available during playback (you can't access it from the MODE SETTINGS menu).*

1. To set up Repeat A-B, start playback – press  (play/pause).
2. When the song you're playing reaches the place that you want to be the starting point, press A -B (soft key 4). You'll notice that the  icon appears in the LCD where the other mode icons are displayed.
3. Continue to let the music play. When you reach the end of the segment you want to repeat, press A-B again (soft key 4). The  icon appears in the LCD.

*Note: You can only mark A and B points within the same song or track.*

4. The Lyra Jukebox will repeatedly play the segment of music you marked. To cancel A-B repeat and return to normal playback, just press the MODE button.

## Adjusting DSP Settings

DSP Settings (Digital Signal Processor settings) adjust the the various levels of the audio output for different types of songs. For example, the DSP setting for BASS makes the bass sounds more prominent. You can also personalize the levels via the *GRAPHIC EQ* menu item. The default DSP setting for your Lyra Jukebox is *FLAT*.

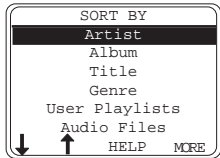

Soft key 4

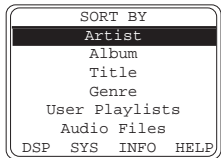

Soft key 1

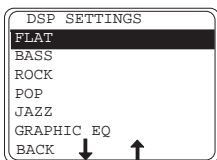

Soft key 3  
Soft key 2

1. From the main menu, press *MORE* (soft key 4).

2. Select *DSP* (press soft key 1). The *DSP SETTINGS* menu appears.

3. Press the arrow down (or soft key 2) or arrow up (soft key 3) to highlight the DSP setting you want to use.

- FLAT
- BASS
- ROCK
- POP
- JAZZ
- GRAPHIC EQ: enables you to personalize audio output settings. Go to the next section for instructions.

*Note: When the Lyra Jukebox is playing, you can cycle through the DSP settings by pressing DSP (soft key 2). The new DSP setting will take effect immediately and the DSP display text will be updated.*

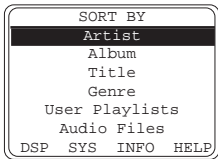

Soft key 1

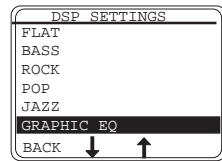

Soft key 2

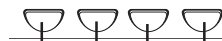
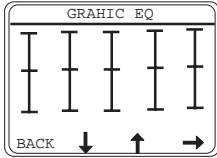

Soft key 1

Soft key 2

Soft key 3

Soft key 4

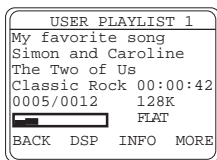

## Personalizing DSP Output (GRAPHIC EQ menu item)

1. During navigation, press soft key 1 (DSP).
2. Press soft key 2 (arrow down) until *GRAPHIC EQ* is highlighted (the *GRAPHIC EQ* submenu appears automatically after *GRAPHIC EQ* has been highlighted for a second or two).
3. Press soft key 2 (down arrow) to decrease the level for the first equalizer band. Press soft key 3 (up arrow) to increase the level of the first equalizer band.
4. When you have the level for this first equalizer band where you want it, press soft key 4 (right arrow) to go to the next equalizer band.
5. Repeat steps 3 and 4 until you have all of the equalizer bands where you want them.
6. Press *BACK* (soft key 1) when all EQ settings are set, or let the display timeout and return to navigation.

*Note: When you're playing music, you can access GRAPHIC EQ by pressing soft key 2 (DSP) until the EQ selection appears. After a few seconds, the GRAPHIC EQ submenu automatically appears.*

## Setting LCD Preferences (SYSTEM SETTINGS menu)

You can personalize the setting of your LCD (Liquid Crystal Display).

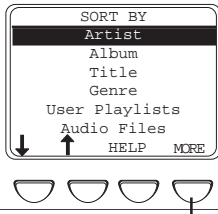

1. From the *SORT BY* menu (the main menu), press soft key 4 (*MORE*). Four new menu items appear at the bottom of the LCD screen.

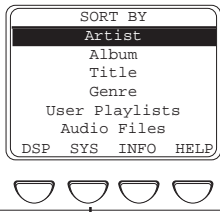

3. Highlight *SYS* (press soft key 2). The *SYSTEM SETTINGS* menu appears.

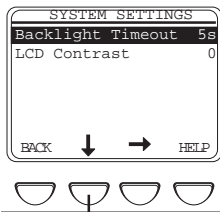
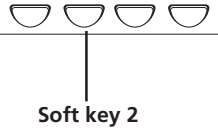

4. Highlight the setting you want to adjust (to highlight LCD Contrast press soft key 2 – the down arrow). Instructions for adjusting *LCD Contrast* and *Backlight Timeout* follow:

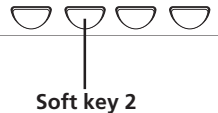



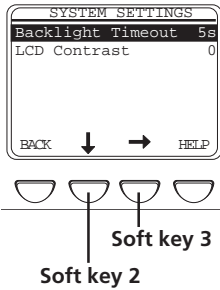

- **Backlight Timeout:** you can adjust the amount of time that the backlight stays on by highlighting *Backlight Timeout*. Press ► (the right arrow button on your Lyra Jukebox) to increase the amount of time. Press ◀ (the left arrow button) to decrease the amount of time.

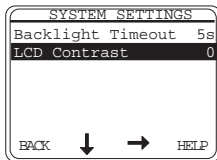

- **LCD Contrast:** to increase the contrast (make the letters darker and the background lighter), press ► (the right arrow button). To decrease the contrast, press ◀ the left arrow button.

## Playing Your Lyra Jukebox in your car stereo

The cassette adapter lets you listen to the Lyra in an automobile or RV safely without having to wear headphones.

The car kit is included with your Lyra Jukebox. This accessory kit includes a car cord adapter (#54095) and a cassette adapter (#54097). The car cord adapter lets you power your Lyra from the cigarette lighter socket of a car, truck, or RV. It converts 12-volts to a 4.5-volt output.

1. Insert the plug on the cassette adapter into the headphone jack on the player. If the headphones are attached, remove them.
2. Set your cassette player to your normal listening level.
3. Insert the cassette (Side A up) into your cassette player making sure the cord is placed in the correct position for your type of player.
4. Attach the end of the car cord adapter to the DC IN jack on your Lyra Jukebox (the POWER light comes on).
5. Remove the cigarette lighter from the socket, and insert the car cord into the socket.
6. Turn on your Lyra Jukebox, and operate the Lyra Jukebox to play music as described in Chapter 1.
7. Control the volume with the cassette player.
8. When you're finished,
  - A. Remove the cassette adapter from the cassette player.
  - B. Turn off the Lyra Jukebox.
  - C. Remove the car cord's plug from the cigarette lighter socket.

*Cautions: Make sure to place the wire securely into the slot on the cassette in the correct direction for the type of player you have. The car cord adapter is designed to be used only with vehicles having negative ground electrical systems. Use of any other car cord adapter may damage your Lyra Jukebox and void your warranty.*

### Playing Your Lyra Jukebox on your stereo system

Your Lyra Jukebox came with a Line Out Cable that you can use to connect your Lyra to your audio system.

1. Make sure your Lyra Jukebox is off.
2. Connect the black end of the cable to the LINE OUT jack on your Lyra Jukebox player.
3. Connect the red (audio left) and white (audio right) cables to the corresponding left and right audio jacks on your stereo system.
4. Turn on the power to your audio system, and select the proper input setting on the audio system that corresponds with the way you've connected the Lyra Jukebox to the audio system.
5. Turn on your Lyra Jukebox – press and hold  for 2 seconds.
6. Operate the Lyra Jukebox to play music as described in Chapter 1.

## Portable Hard Drive Capability

Thus far, this User's Guide has discussed your RD 2800 Lyra Jukebox player's music functions. However, this is the first Lyra model that has a hard drive (other models required a compact flash card). Since it has a 10-gigabyte hard drive, you can use it to transport files — any files, not just music files. Some possible uses for this feature follow:

- Create back-ups/archive files
- Connect to other computers — at work, for example.
- Transport digital photo albums.
- Transport files from one computer to another computer. For example, instead of putting files at work on a zip or accessing them on your home computer via e-mail or remote access, you can put the files on your Lyra Jukebox.
- Capture internet downloads.
- Share information.

## Connecting your Lyra Jukebox to your Computer

You connect the Lyra Jukebox to your computer via the USB mini-cable (provided).

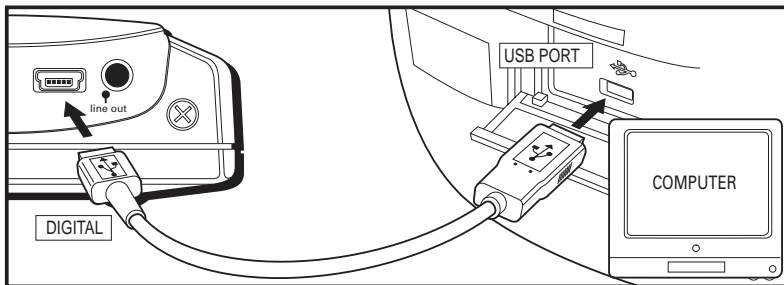

1. Connect the Lyra Jukebox to your computer with the mini USB cable provided. The Lyra Jukebox will appear as a Removable Disk drive letter.

*Note: It might take several seconds for the device (the Lyra Jukebox) to be detected, especially in Windows 2000. Click Refresh in My Computer or Explorer to make sure the device has been detected.*

2. From Windows Explorer, highlight all of the files/folders you want to transfer to your Lyra Jukebox and drag them to the drive letter that is associated with it
3. Go to page 31 for more information about transferring files.

# Additional Information

## Chapter Overview:

- Tips & Troubleshooting
- FAQ (Frequently Asked Questions)
- Specifications & System Requirements
- Limited Warranty
- Index

Changing Entertainment. Again.



## Tips and Troubleshooting

### Problem: Player repeats same tracks or all tracks.

- Repeat play is turned on. Press the MODE button to change the play mode.

### Problem: Audio distorted at high volume.

- In DSP mode, reduce the *BASS* gain.
- Select another DSP setting.
- Turn down the volume.

### Problem: The audio tracks on my Lyra keep skipping or popping.

- You'll need to re-record the audio track – make sure you close all other applications on your PC when you record.

### Problem: Player turns itself off.

- Your Lyra Jukebox turns itself off if you leave it in pause mode for an inordinate amount of time.

### Problem: Songs aren't listed in any of the sort modes (Album, Genre, Title, Audio Files).

- The contents of the Lyra Jukebox haven't been profiled (sorted) since the last file transfer. Select the *Profile Lyra MP3/Personal Jukebox Device* menu item from the Lyra Jukebox profiler system tray application on your PC to profile (sort) the contents of the device. The icon in the system tray looks like this .

### Problem: Bad or missing file error message displayed on the Lyra Jukebox.

- The Lyra Jukebox system files are corrupted or missing. Select the *Update Lyra Jukebox System Files* menu item from the Lyra Jukebox profiler system tray application on your PC to update the necessary system files.

### Problem: Lyra Jukebox Profiler application icon – – doesn't appear in the system tray.

- You can restart Windows to auto-launch the application, or you can double-click the Lyra Jukebox Profiler sub-folder of the installation directory that was specified during the setup process (Example Directory: C:\Program Files\Thomson multimedia\Lyra MP3 Jukebox\Profiler\LYRAHDDProfilerTrayApp.exe)

If the problem persists, you might need to reinstall the Lyra Jukebox software.

## FAQ (Frequently Asked Questions)

### Question: What is MP3?

MP3 is an abbreviation for MPEG-1, Layer 3 Audio (MPEG = Motion Picture Experts Group). This is a digital sound encoding and compression process that was developed by the Fraunhofer Institut für Integrierte Schaltungen and Thomson multimedia. MP3 is an international standard and is well suited for the transfer of high quality audio files over telephone or ISDN lines, and over the internet.

## Specifications & System Requirements

### Hardware

- Dimensions: 1.1" D, 5.1" W, 3.0" H
- Unit Weight: 11.0 Ounces
- 10 Giga Byte Storage (RD2800) / 20 Giga Byte Storage (RD2820)
- Stereo Headphone Jack
- Adaptive Navigation Softkeys
- Mini USB Connection Jack
- Stereo Line Out Jack
- External 5V DC Jack
- Battery Operated: Up to 12 hours of playback with internal rechargeable Lithium ion battery.

## Hard Disc

- External Hard Disc Drive: When connected to a computer via USB, the Lyra Hard Disc player is capable of storing any file type allowing the user a fast, convenient method of storing, retrieving, and transferring files. Including word processing files, presentations, spreadsheets and any other computer files.
- Capacity: 10GB (RD2800) / 20GB (RD2820)
- Rotational Speed: 4200 RPM
- Average Access Time: 12 MS
- Connection: USB 1.1

## Software

- Includes Music Management software with the Lyra Jukebox applications and the MusicMatch Jukebox software.

MusicMatch Jukebox software lets the user organize all tracks in a digital music library, create custom playlists through drag and drop interface.

- Encodes MP3 files.
- Auto DJ creates automatic Playlists based on the user's sorting preferences. Scans the entire Music Library for specific search results.
- Integrated CD Player.
- Export to WAV
- MP3 Equalizer



## PC Hardware Requirements

- 233MHz or higher (Pentium II 300 MHz or higher recommended)
- Windows® 98SE, Me, XP or 2000
- Internet Explorer 4.0 or better with Internet access
- 32 MB RAM (64 MB recommended)
- Free hard disk space (4 MB for the software plus 1 MB for every minute of CD quality audio that will be stored on the PC).
- CD-ROM drive capable of digital audio extraction
- USB port
- Installed sound card
- 16-bit color video card

## Accessories

- CD-ROM Music Management Software
- USB Connection Cable
- AC/DC Adapter
- X-Phone™ Stereo Headphones
- Audio Line-Out Cable
- Car DC Adapter: Supplies power to Lyra Jukebox player from car battery via cigarette lighter plug.
- Car Cassette Audio Output Adapter

## Miscellaneous Specifications

- Signal to Noise Ratio (>85dB)
- THD (<0.1%)

1 MusicMatch and MusicMatch Jukebox are registered trademarks of MusicMatch Corp.

2 Warning – This product is not intended for the unauthorized recording or duplication of copyrighted material.

## Limited Warranty

### What your warranty covers:

- Defects in materials or workmanship.

### For how long after your purchase:

- 90 days from date of purchase - Unit repair or exchange, which includes parts and labor.
- 91 days to 1 year from date of purchase - Unit repair or exchange, which includes parts only; you pay the labor.
- The warranty for rental units begins with the first rental or 45 days from date of shipment to the rental firm, whichever comes first.

### What we will do:

- **During the initial 90 days:**

Repair or exchange the defective portion of your Hard Drive. If the unit is replaced it will be with a new or, at our option, refurbished unit.

- **After the 90 days and within one year:**

Repair or exchange the defective portion of your Hard Drive. If the unit is replaced it will be with a new or, at our option, refurbished unit.

We will charge you a flat rate to repair or replace a defective Hard Drive. This charge covers the labor cost for its repair.

### How you get service:

- Contact us on the Internet at [www.lyrazone.com](http://www.lyrazone.com) and have your unit's date of purchase and model/serial number ready. The model/serial number information is on your unit.
- Self diagnostic screens will allow you to troubleshoot your problem over the Internet.
- If after going through the troubleshooting screens, you determine that your player requires service, contact us at 317-415-4391. You must contact us to obtain a Service Request Number (SR) for a service repair or exchange. No returns will be accepted without the SR number.
- Proof of purchase in the form of a bill of sale or receipted invoice which is evidence that the product is within the warranty period must be presented to obtain warranty service. For rental firms, proof of first rental is also required.

- Write the SR number on the outside of the carton used to return the unit. Make sure you insure your shipment in case of damage or loss.
- Carefully pack the unit using the original box and packing material if possible. Please retain all non-defective accessories that were included with your unit such as the headphones.
- Include with the shipment:
  1. Evidence of purchase date such as a bill of sale.
  2. A brief note describing your unit's problem.
  3. Your name, address and phone number.
- After we receive your product, it will be repaired, or a new, or at our option, refurbished unit will be shipped to you.
- Please retain a copy of all items loaded into your Hard Drive. Thomson multimedia will not be responsible for your software, firmware, information, or memory data contained in, stored on, or integrated with any products returned to Thomson for repair or exchange whether in or out of warranty.

### **What your warranty *does not* cover:**

- Acts of nature, such as but not limited to lightning damage.
- Adjustment of customer controls.
- Damage from misuse or neglect.
- A unit that has been modified or incorporated into other products or is used for institutional or other commercial purposes.
- Batteries.
- Units purchased, serviced or operated outside the U.S.A.
- Loss of customer's software, firmware, information, or memory data.
- Installation.
- Shipping damage if the unit was not packed and shipped in the manner prescribed by Thomson.

### **Product Registration:**

- Please complete and mail the Product Registration Card packed with your Hard Drive. It will make it easier to contact you should it ever be necessary. The return of the card is not required for warranty coverage.

# Additional Information

---

## Limitation of Warranty:

- **THE WARRANTY STATED ABOVE IS THE ONLY WARRANTY APPLICABLE TO THIS PRODUCT. ALL OTHER WARRANTIES, EXPRESS OR IMPLIED (INCLUDING ALL IMPLIED WARRANTIES OF MERCHANTABILITY OR FITNESS FOR A PARTICULAR PURPOSE) ARE HEREBY DISCLAIMED. NO VERBAL OR WRITTEN INFORMATION GIVEN BY THOMSON MULTIMEDIA INC., ITS AGENTS OR EMPLOYEES SHALL CREATE A WARRANTY OR IN ANY WAY INCREASE THE SCOPE OF THIS WARRANTY.**
- **REPAIR OR REPLACEMENT AS PROVIDED UNDER THIS WARRANTY IS THE EXCLUSIVE REMEDY OF THE CONSUMER. THOMSON MULTIMEDIA INC. SHALL NOT BE LIABLE FOR INCIDENTAL OR CONSEQUENTIAL DAMAGES RESULTING FROM THE USE OF THIS PRODUCT OR ARISING OUT OF ANY BREACH OF ANY EXPRESS OR IMPLIED WARRANTY ON THIS PRODUCT. THIS DISCLAIMER OF WARRANTIES AND LIMITED WARRANTY ARE GOVERNED BY THE LAWS OF THE STATE OF INDIANA. EXCEPT TO THE EXTENT PROHIBITED BY APPLICABLE LAW, ANY IMPLIED WARRANTY OF MERCHANTABILITY OR FITNESS FOR A PARTICULAR PURPOSE ON THIS PRODUCT IS LIMITED TO THE APPLICABLE WARRANTY PERIOD SET FORTH ABOVE.**

## How state law relates to warranty:

- Some states do not allow the exclusion nor limitation of incidental or consequential damages, or limitations on how long an implied warranty lasts, so the above limitations or exclusions may not apply to you.
- This warranty gives you specific legal rights, and you also may have other rights that vary from state to state.

## If you purchased your product outside the United States:

- This warranty does not apply. See your dealer for warranty information.

# Index

## A

- A-B Repeat 35
- AC/DC adapter charger 6
- Adapter
  - AC/DC 6
  - car 6, 40
- ADD button 29
- Album menu 14
- All Files menu 20
- Analog setting 27
- Arrow button 8
- Arrow buttons
  - left 11
  - right 11
- Artist menu 13
- Assistance 4, 26, 34, 44, 48
- Audio Files menu 19
- Audio problems 44

## B

- Backlight Timeout, changing 39
- Backup data 4
- Bad file message 44
- Basic operation 10
- Bass 36
- Battery, charging 12
- Box, what's in the 6
- Buttons
  - down arrow 8
  - explanation 7
  - left arrow 8, 11
  - MODE 7, 11
  - play/pause 8
  - RESET 9
  - right arrow 8, 11
  - SAVE 7
  - SELECT 7
  - Soft 8
  - STOP 11

- STOP/power 8
- up arrow 8
- volume down 7, 11
- volume up 7, 11

## C

- Cables
  - line out 6, 9
  - USB 6
- Car
  - adapter 6, 40
  - play the Lyra in 40
- Case 6
- CD 6, 22
  - contents 23
- CD quality setting 27
- CD recording mode 27
- CDDDB Preferences 28
- Changing play modes 35
- Changing the order of songs 19
- CHARGE light 9
- Charger 6
- Computer requirements 4
- Connecting
  - car adapter 40
  - to stereo system 41
  - to your computer 24
- Creating a playlist 30
- Customer service 48

## D

- Data 4
- DC IN jack 9
- Digital and Error Correction setting 27
- Display 7
- Down arrow button 8
- Download music from the internet 29
- Drivers 22, 23
- DSP Output 37
- DSP Settings menu 36

## E

- Eject hardware icon *12*
- Error messages *44*

## F

- Flat *36*

## G

- Genre menu *16*
- Graphic EQ *36*
- GRAPHIC EQ menu *37*

## H

- Headphones *4, 6*
- Headphones jack *9*
- Help *26, 48*

## I

- Icon
  - MusicMatch *25*
- Icons
  - eject hardware *12*
  - key *9*
  - lock *9*
  - Lyra Jukebox profiler application *25*
  - play mode *34*
  - playback *21*
  - unplug *12*
- ID3 tags *15*
- Important information *2*
- Installing software *22*
- Instruction book *23*
- Instructions
  - setup *22*
  - step-by-step *12*

- Internet *29*

## J

- Jack
  - DC IN *9*
  - Headphones *9*
  - LINE OUT *9*
- Jazz *36*

## K

- Key icon *9*

## L

- L.E.D.
  - CHARGE *9*
  - POWER *9*
- LAN system *28*
- LCD *7*
  - adjusting contrast *39*
  - Backlight Timeout: *39*
  - changing appearance *38*
- LCD Contrast *39*
- LCD Screen *21*
- Left arrow button *8, 11*
- Light
  - CHARGE *9*
  - POWER *9*
- Limited Warranty *48*
- Line Out cable *6*
- Line out cable *41*
- LINE OUT jack *9*
- LOCK switch *9*
- Logo, RCA *12*
- Loss of data *4*
- Lyra Jukebox profiler application icon *25*

## M

### Menus

- Album *14*
- All Files *20*
- Artist *13*
- Audio Files *19*
- DSP Settings *36*
- Genre *16*
- Graphic EQ *37*
- Profile Lyra MP3/Personal Jukebox Device *25*
- Sort By *10*
- System Settings *38*
- Title *15*
- Update Lyra MP3/Personal Jukebox System *25*
- User Playlists *18*

- Mini USB cable *6, 24*
- Missing file message *44*
- MODE button *7, 11*
- MP3 *27*
- Music Guide *29*
- Music Library *29*
- Music Management CD *6*
- MusicMatch icon *25*
- MusicMatch Radio *29*
- Mute while Recording setting *27*

## O

- OFF/LOCK switch *9*
- Operation, playback *11*
- Options menu *26*

## P

- Parts checklist *6, 44, 45*
- PC Requirements *4*
- Play modes *34*
- Play/pause button *8*
- Playback operation *11*
- Playback problems *44*
- Playing music *11*
- Playlists *18, 30*
- Pop *36*
- POWER light *9*
- Power adapter *9*
- Power button *8*
- Problems, solving *44*
- Product registration *2*
- Profile Lyra MP3/Personal Jukebox Device menu *25*

## R

- RCA Lyra logo *12*
- Rearranging the order of the songs *19*
- Recorder settings *26*
- Recording quality level *27*
- Repeat A-B *35*
- Requirements
  - computer *4, 47*
- RESET button *9*
- Right arrow button *8, 11*
- Rock *36*

## S

- SAVE button 7
- SELECT button 7
- Settings menu 26
- Setup instructions 22
- Soft keys 8
- Software 22
- SORT BY menu 10
- Sorting
  - by Album 14
  - by All Files 20
  - by Artist 13
  - by Audio Files 19
  - by Genre 16
  - by Title 15
  - by User Playlists 18
- Sorting problems 44
- Specifications
  - accessories 47
  - hard disc 46
  - hardware 45
  - software 46
- Step-by-step instructions 12
- STOP button 8, 11
- Storage space 20
- Stuff packed with the player 6
- System Profiler Application 23
- System Settings menu 38
- System tray 25

## T

- Title menu 15
- Troubleshooting 44

## U

- Unplug icon 12
- Up arrow button 8
- Update Lyra MP3/Personal Jukebox System menu 25
- USB 23
- USB cable 6, 24
- USB port 9
- User Playlists 30
- User Playlists menu 18
- User's Guide 23

## V

- Volume down button 7, 11
- Volume level indicator 21
- Volume up button 7, 11

## W

- Warranty 48
- WAV audio 27
- Windows Media 27



**(This page intentionally left blank.)**

**visit us at [www.rca.com](http://www.rca.com) or [www.lyrazone.com](http://www.lyrazone.com)**

---

Please do not send any products to the Indianapolis address listed in this manual or on the carton. This will only add delays in service for your product.

**Thomson multimedia Inc.**

P.O. Box 1976

Indianapolis, IN 46206-1976

©2002 Thomson multimedia Inc.

Trademark(s)® Registered

Marca(s) Registrada(s)

  
**THOMSON**

**THOMSON** 

**TOCOM**