

# 638 Series



## Digital Servo Drive



**Product  
Manual**

# Additional Supporting Documentation

---

UL: CD



**EASYRIDER® Windows - Software**

---

UL: 07-02-09-02



**HIPERFACE® Feedback System**

---

UL: 07-05-02-03



**Product Manual - Bus Interface SUCOnet K**

---

UL: 07-05-03-02



**Product Manual Bus Interface CAN**

---

UL: 07-05-04-02



**Product Manual - Bus Interface Profi Bus DP**

---

UL: 07-05-05-02



**Product Manual - Bus Interface Interbus S**

---

UL: 07-05-07-02



**Product Manual - I/O Interface**

---

UL: 07-05-08-02



**Product Manual - Bus Interface DeviceNet**

---

UL 07-09-04-02



**Product Manual - Suppression Aids EH**

---

UL: 10-06-03



**Product Manual – Serial Transfer Protocol EASY-Serial**

---

# Additional Supporting Documentation

---

UL: 10-06-05



**Product Manual - BIAS® Commands**

---

UL: 12-01



**Product Manual - Plugs**

---

UL: 12-02



**Product Manual - Cables**

---

UL: 12-03



**Product Manual - Ballast Resistors**

---

©Parker Hannifin GmbH Co. KG

All rights reserved. No portion of this description may be produced or processed in any form without the consent of the company.

Changes are subject to change without notice.

**Parker Hannifin** has registered in part trademark protection and legal protection of designs. The handing over of the descriptions may not be construed as the transfer of any rights.

Made in Germany, 2008

# Table of Contents

	Page
<b>The Most Important Thing First .....</b>	<b>8</b>
<b>Safety Precautions .....</b>	<b>9</b>
<b>1 General Information.....</b>	<b>11</b>
1.1 System Description .....	11
• Special Features of the 638 Servo Drive .....	11
• Overview of Standard Digital Communication .....	11
• Determining Criteria for the Utilization of the 638 Drive.....	12
• Operation Configuration .....	12
1.2 Model Code .....	13
• Combination Possibilities for the Various Communication / I/O - Modules.....	14
• Module Slots Layout.....	15
• Module Design .....	15
1.3 Dimensions.....	16
• 638A Series.....	16
• 638B Series.....	17
<b>2 Connection Assignments and Functions .....</b>	<b>18</b>
2.1 Insulation Concept .....	18
2.2 Overview of Compact Unit Connections .....	19
• <u>638A01.. to 638A06..</u> .....	19
• <u>638B03.. to 638B15..</u> .....	20
2.3 Assignments Power Connections .....	21
• Power, Ballast, DC Bus - Connection <u>X60</u> .....	21
• 24V - Control Supply Voltage <u>X01</u> .....	21
• Motor - Connection <u>X61</u> .....	21
• Brake / Thermo - Connection <u>X62</u> .....	22
2.4 Feedback Sensor X30.....	23
• Feedback - Module X300 .....	23
• Feedback Connection X30 (SUB D 09 Socket) .....	24
• Feedback - Module X300 with Memory 638A.....	25
2.5 Service-Interface COM1 (RS232).....	26
2.6 Safe Torque Off.....	27
• Connection Safe Torque Off X11 .....	27
• Connection WITHOUT the utilization of the Safe Torque Off, (STO), function.....	27
2.7 Signal Connection .....	28
• Control Signal Plug X10 (SUB D25 Socket) .....	28
2.8 Multi-Function X40 .....	29
• Incremental - <u>Output</u> .....	30
• Incremental - <u>Input</u> .....	30
• Stepper Motor <u>Input</u> .....	31
• SSI-Encoder Interface .....	32
2.9 Fieldbus Interface <u>COM2</u> .....	33
• Pinning for RS232 .....	33
• Pinning for RS422/485 .....	33
• Pinning for CAN or DeviceNet.....	34
• Pinning for Profibus DP .....	34
• Pinning for SUCOnet K .....	34
• Pinning for EA5 I/O-Interface (Digital In and Outputs).....	35
2.10 Fieldbus Interface <u>COM2</u> in Combination with <u>COM3</u> (OPTION SLOT A/B) .....	36
• Pinning for Interbus S (RP IBS) .....	36
2.11 Fieldbus Interface RP 2CA, 2C8.....	37
• Pinning CAN1-BUS and CAN2-BUS.....	37
• Pinning RP 2C8 X120 (with I/O's).....	37
– DIP Switch Position for Option Module RP 2CA and RP 2C8 .....	38
2.12 Fieldbus Interface RP CCA, CC8.....	39
• Pinning CAN1-BUS, CAN2-BUS and RS485.....	39
• Pinning RP CC8 X120 (with I/O's) .....	39
– DIP Switch Position for Option Module RP CCA and RP CC8 .....	40

# Table of Contents

	Page
<b>Connection Assignments and Functions</b>	
2.13	Fieldbus Interface RP PCA, PC8 .....41
•	Pinning Profibus DP and CAN2-BUS and RS485 .....41
•	Pinning RP PC8 / X120 (with I/O's).....41
–	DIP Switch Position for Option Module RP PCA, PC8 .....42
2.14	Overview of the Terminal Cross Section.....43
<b>3</b>	<b>Operating Mode ..... 44</b>
3.1	Operating Mode General.....44
3.2	Operating Modes and Pin Functions.....45
3.3	Configurable Pin Functions (Operating Mode Dependent).....46
3.4	Functions Diagrams with Protection Mode “Switch Off” .....47
<b>4</b>	<b>Mechanical Installation ..... 49</b>
4.1	Mounting.....49
4.2	Control Cabinet Mounting .....49
4.3	Cooling and Ventilation .....49
<b>5</b>	<b>Electrical Installation ..... 50</b>
5.1	Installation General .....50
•	Safety .....50
•	Danger of Electric Shock.....50
•	Dangerous Areas .....50
•	Grounding - Safety Grounding .....50
•	Ground Connections .....50
•	Short-Circuit Capacity and Discharge Currents.....50
5.2	Power Mains Connection .....51
•	Types of power mains .....51
•	Mains supply voltage range 638A.....51
•	Mains supply voltage range 638B/C .....51
•	Protective Ground Connection (PE).....51
–	Cable cross section.....51
•	Dimensioning of power mains cable and the over-current protection.....51
5.3	DC Link Parallel Connection .....54
•	General.....54
•	Variation 1; Servo Drives without DC LINK protection.....54
•	Variation 2; Servo Drives with DC LINK protection.....55
•	Function Softstart.....56
•	Installation Instructions and Warnings .....56
•	Layout of the Ballast Capacity.....57
5.4	Fuses , Contactors .....58
•	638A .....58
•	638B .....58
•	638C .....58
5.5	Brake Resistor.....59
•	Selection of the Brake Resistor .....59
•	Configuration of the Brake Resistor .....60
<b>6</b>	<b>Wiring Instructions ..... 62</b>
6.1	General Wiring Instructions.....62
•	General Information .....62
•	Control Cabling.....62
•	Power Cabling.....62
•	Analog Setpoint.....62
•	Safety Rules .....62
6.1	Electromagnetic Compatibility (EMC) .....63
•	Hints for Mounting .....63
•	Example for Mounting .....64

# Table of Contents

---

	Page
<b>7</b>	<b>Hardware Configuration..... 65</b>
7.1	Jumpers.....65
•	Power Board Layout Plan 638A.....66
•	Power Board Layout Plan 638B/C .....66
<b>8</b>	<b>Commissioning..... 67</b>
8.1	Commissioning Preparation.....67
8.2	Step 1 : Wiring and Communications Test.....68
8.3	Step 2 :Feedback Test and Motor Selection.....69
•	Step 2.2 Motor Selection .....70
•	Step 2.3 Motor with Resolver Feedback .....71
•	Step 2.4 Motor with HIPERFACE Feedback.....71
•	Step 2.5 Motor with SIN-COS Feedback Linear Motor.....71
8.4	Step 3 : Power Up and Drive Activation .....72
•	Step 3.1 Power Up .....72
•	Step 3.2 Drive Activation .....72
8.5	Step 4 : Control Loop Optimization .....73
•	Step 4.1 Control Loop Optimization with Rotary Motors.....73
•	Step 4.2 Control Loop Optimization with Linear Motors .....74
8.6	Step 5 : Operation Mode Selection .....75
8.7	Step 6 : Fieldbus Interface .....76
8.8	Step 7 : Data Save .....77
<b>9</b>	<b>Safe Torque Off (STO)..... 79</b>
9.1	General Introduction.....79
•	Important Technical Terms and Explanations.....79
•	Stop Category according to EN 60204-1 (Chapter. 9.2.2).....80
•	Applications in Accordance with the Regulations .....81
•	Trained Personnel.....81
•	Benefits with the Employment of the Safe Torque Off Function .....81
•	Safety Instructions and Limitations .....82
9.2	Safe Torque Off Function, (STO) .....83
•	Block Circuit Diagram.....83
•	Status Diagram and Function of Terminals STO1# und STO2# .....84
9.3	Configuration and Parameter Settings.....85
9.4	Application Example of STO (Safe Torque Off) .....90
•	Application Example 1.....91
•	Application Example 2.....92
•	Application Example 3.....93
•	Application Example 4.....94
9.5	STO Function Test .....95
9.6	Signal Inputs Technical Data - Terminal Connection X11 .....97
<b>10</b>	<b>Diagnosis and Trouble-Shooting ..... 98</b>
10.1	7-Segment-Display.....98
10.2	Reset of a Drive Trouble .....103
10.3	Trouble-Shooting.....104
<b>11</b>	<b>Standards and Certifications..... 105</b>
11.1	Compliance with Regulations, Limitations and Basic Conditions .....105

# Table of Contents

	Page
<b>12</b>	<b>Technical Data ..... 107</b>
12.1	General Technical Data ..... 107
•	Power Circuit ..... 107
•	Control Circuit ..... 107
•	Signal Inputs and Outputs - Connection X10 ..... 107
•	Thermo-Control X30 ..... 107
•	Thermo-Control X62 ..... 108
•	Brake-Control X62 ..... 108
•	Signal Inputs and Outputs - Connection X120B resp. 120C ..... 108
•	Digital Control ..... 109
•	Digital Communication ..... 109
•	Resolver Evaluation / Transmitter Principles ..... 109
•	Controller System ..... 110
•	Mechanical Data ..... 110
12.2	Technical Unit Data ..... 111
•	638A ..... 111
•	Output Power 638A ..... 112
•	Singlephase and Threephase supply ..... 112
•	638B ..... 113
•	Output Power 638B ..... 114
<b>13</b>	<b>Software ..... 115</b>
13.1	EASYRIDER® Windows - Software ..... 115
13.2	Introduction ..... 116
•	Program layout ..... 117
•	Execute a BIAS program ..... 117
•	Execute a PLC program ..... 118
•	Execute a Mathematics program ..... 118
13.3	BIAS - Commands ..... 119
<b>14</b>	<b>Appendix ..... 120</b>
14.1	STO - Safety - Parameter - Report - Proposal ..... 120
<b>15</b>	<b>Memo ..... 121</b>
<b>16</b>	<b>Modification Record ..... 122</b>

# The Most Important Thing First



---

**Thank you for your confidence in choosing our products.**

These operating instructions are intended to provide an overview of the technical data and features of our products.

**Please read the operating instructions completely before operating the product.**

Should you have any questions, please contact your nearest service representative.

	<b>Improper application of this product in combination with dangerous high voltage can lead to serious injury or death.</b>
	<b>Damage can also occur to motors or other products. Therefore, we request that you strictly observe our safety and installation instructions.</b>

## Safety Precautions

We assume that as an expert, you are familiar with and will observe all of the relevant safety regulations, especially in accordance with VDE 0100, VDE 0113, VDE 0160, EN 50178, the accident prevention regulations of the employer's liability insurance company and the DIN regulations.

Additionally, it is imperative that all relevant European Union Safety Directives be observed.

Depending on the type and location of the installation, additional regulations, e.g. UL, DIN, must also be fully observed.

If our products are operated in connection with components from other manufacturers, their operating instructions are also subject to be strictly observed.





### Attention !

Digital servo drives, corresponding to EN 61800-5-1/VDE 0160, are electronic power components utilized for the regulation of the flow of energy in high-voltage electrical power installations. They are exclusively designed, configured and approved to supply our servo motors. Handling, installation, operation, and maintenance are only permitted under the conditions of and in keeping with the effective and/or legal regulations, regulation publications and this technical document.

**The operator must make sure that these regulations are strictly followed.**

#### **The Concept of Galvanic Separation and Insulation:**

Galvanic separation and insulation corresponding to EN 61800-5-1/VDE 0160, provides for additional insulation protection.

**In addition**, all digital signal inputs and outputs are provided with a galvanic separation utilizing either a relay or an optical coupler. In this way, an increased level of protection against potential interference and a limitation of potential damage due to incorrect connections are provided.

The voltage level must not exceed the designated low safety voltage of 60V DC or 25V AC, respectively, in accordance with EN 61800-5-1/VDE 0160.

The operator must make sure that these regulations are strictly followed.



### Danger !

**High Voltage!  
Danger of Electrocution!  
Life Threatening Danger!**

**Certain parts of the servo drive are supplied with dangerous electrical current. Physical contact with these components can cause death, life threatening injuries and/or serious damage to equipment and property.**



### Caution !

**Due to safety considerations and product guarantees, the operator is prohibited from opening the servo drive case. Service, maintenance and repair of our products should only be carried out by specified representatives of the company. Expert configuration and professional installation, as described by this document, are the best way to insure problem-free operation of our servo drives!**

## Safety Precautions

---

**Please  
Observe !**

**Pay Special Attention to the Following:**

Permissible Protection Class: Protective Grounding - operation is only permitted when the protective conductor is connected according to regulations.

Operation of the servo drive when employing a residual current operated protective device as the sole protection against indirect touching, is not permissible.

**The servo drive may only be used in conjunction with machines or electrical systems when placed in control cabinets which comply with EEC- Directive 98/37/EEC (Machine Directive) and EEC Directive 89/336/EEC (EMC – Directive).**

Work on or with the servo drive may only be carried out with insulated tools. Installation work may only be done in a de-energized state. When working on the

drive, one should not only block the active input, but also separate the drive completely from the main power connection.

**CAUTION - Risk of Electrical Shock:**

Wait 3 minutes after switching the component off to allow the capacitors to discharge.

Screws sealed with varnish fulfill an important protection function and may not be tampered with or removed.

It is prohibited to penetrate the inside of the unit with objects of any kind. Protect the unit from falling parts, pieces of wire, metal parts, etc., during installation or other work in the control cabinet. Metal parts can lead to a short-circuit in the servo drive.

Before putting the unit back into operation, remove any additional covers so that the unit does not overheat. When conducting measurements on the servo drive it is imperative to pay attention to the electrical isolation.



**Stop !**

**We are not liable for damage which may occur when the product instructions and/or the applicable regulations are not explicitly observed!**

## 1.1 System Description

### ● Special Features of the 638 Servo Drive

- The digital 638 servo drive provides for the electrical connection, rotational speed and position control of the **AC servo motor**.
- All of the functions and system controls are digitally regulated, employing a **sampling rate of 105µs**.
- The 638 servo drive supports the safety function "Safe Torque Off", STO, providing for a definitive system shut-down, for protection against an unanticipated start-up, in accordance with the requirements as stated in EN 13489-1, Category 4, Performance Level e and EN1037.
- The feedback generated from the braking energy is dissipated through the employment of internal ballast resistance and when required through the employment of additional external ballast resistance.
- The AC supply voltage can be directly connected or it can be connected through a transformer, as required. (**Important:** only operated on networks which are grounded at the centre point (TN networks))
- The servo drive additionally requires a **24 V DC control supply voltage connection**.
- The **built-in internal EMC filter** corresponds to the requirements regarding susceptibility to interference for industrial systems as described in EN50081-1.
- By employing various option modules, through **2 additional plug-in receptacles**, it is possible to increase the potential connections to the **field bus system** and/or the input/output terminals.
- Various motor feedback loop systems can be supported by employing the flexible feedback module X300.
- Through the employment of additional 638 drives it is optionally possible to couple the DC link.
- Minimal Housing Dimension is provided through the intelligent compact design of the unit.

### ● Overview of Standard Digital Communication

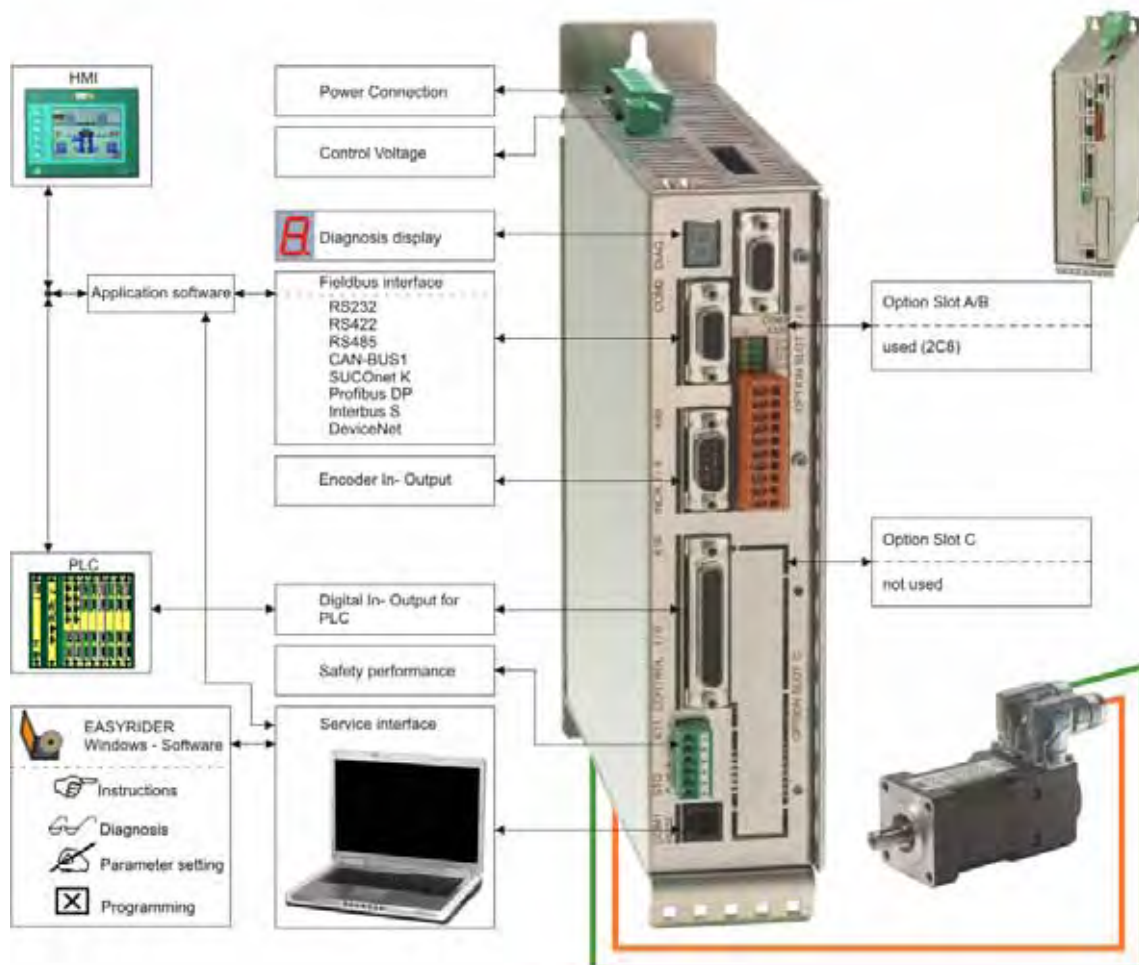

# 1 General Information

- **Determining Criteria for the Utilization of the 638 Drive**

Decisions relating to the appropriate selection of the motor type, feedback system and drive type, as well as the system layout and option modules required, are dependant upon the specific application and the anticipated operating mode of the system.

There are 6 operating modes to choose from:

- 0 Seed / Current control switchable via Input X10.24
- 1 Speed control
- 2 Current control
- 3 Speed / Position control switchable via Input X10.24
- 4 Position control without BIAS – execution
- 5 Position control with BIAS - execution

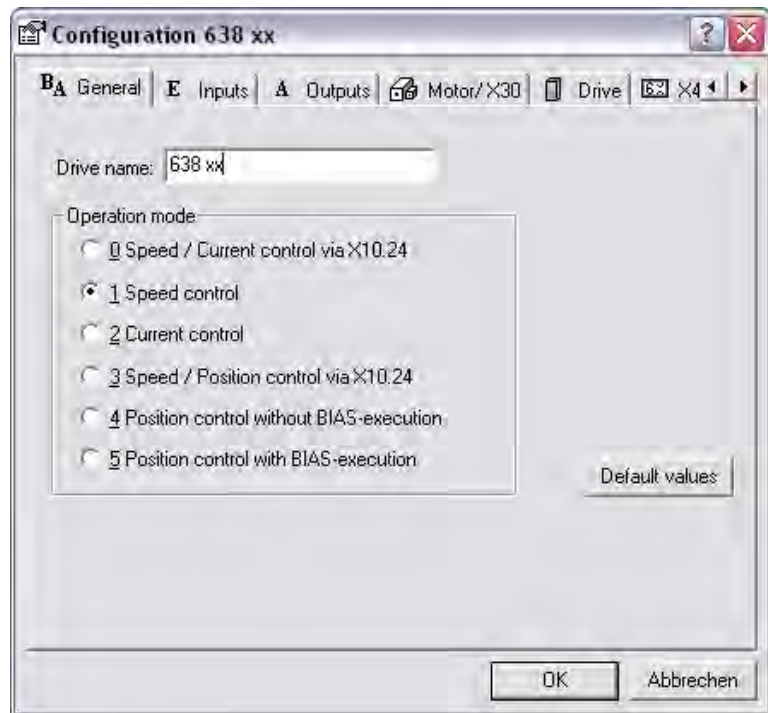

- **Operation Configuration**

There are opportunities ranging from simple current and speed control to programmable position control processes (PLC), supported by the 1500 BIAS command blocks.

"BIAS" User shell for intelligent drive controls:

See Chapters: "[■ Operation Modes](#)" and "[■ Software](#)"

## 1.2 Model Code

											Special		
Marking	a	b	c	d	e	f	g	h	h1	i	j		
Type:	638	X	XX	X	F	X	STO	XXX	XXX	XXX	XXX		
Marking	Description												
a	638 = 6th. Generation Digital Servo Drive												
b	Size:												
	A	= Size A			B	= Size B			C	= Size C			
c	Rated Current:			Rated Current:			being prepared						
	01	= 1,0 amps			03	= 2,5 amps							
	02	= 2,0 amps			05	= 5,0 amps							
	04	= 4,0 amps			08	= 7,5 amps							
	06	= 6,0 amps			10	= 10,0 amps							
					15	= 15,0 amps							
d	Intermediate Voltage:												
	638A			638B									
	3	= 325 VDC / 230 VAC			3	= 325 VDC / 230 VAC							
					6	= 565 VDC / 400 VAC							
					7	= 678 VDC / 480 VAC							
e	F	= With Integrated Filter					= Standard						
	A	= less leakage current (AC-side Y-capacitors deactivated; JP600 open)											
f	0	= Without EMC - Clip					= Standard						
g	Safety Performance:												
	STO	= <b>Safe Torque Off</b>					= Standard						
h	Additional option-module RP -XXX on the drive for communication via <b>COM2</b>												
	000	= No Option											
	232	= RS 232 interface								≙ slot A (A, B)			
	422	= RS 422 interface								≙ slot A (B)			
	485	= RS 485 interface								≙ slot A (B)			
	CAN	= CAN – Bus								≙ slot A (B)			
	2CA	= 2 x CAN (without I/O's)								≙ slot B (A) / [C*]			
	2C8	= 2 x CAN + 4 outputs and 4 inputs								≙ slot B (A) / [C*]			
	CCA	= 2 x CAN + RS 485								≙ slot B (A)			
	PC8	= 2 x CAN2 + 4 outputs and 4 inputs + RS 485								≙ slot B (A)			
	DEV	= CAN - Bus / DeviceNet								≙ slot B (A)			
	SUC	= SUCOnet K								≙ slot B (A)			
	PDP	= Profibus DP								≙ slot B (A)			
	IBS	= Interbus S								≙ slot B (A)			
	PC8	= Profibus DP + CAN2 + 4 outputs and 4 inputs + RS 485								≙ slot B (A)			
	PCA	= Profibus DP + CAN2 + RS 485								≙ slot B (A)			
	EA5	= I/O - Interface (5 inputs, 2 outputs)								≙ slot B (A)			
h1	Additional Options Module on the drive via <b>X200</b>												
	000	= No Option											
	EAE	= I/O - Interface (14 inputs, 10 outputs)								≙ slot C			
i	X300 – Functions Module												
	RD2	= Standard X30 Resolver – Module 2nd Version					= Standard		≙ slot D				
	HF2	= HIPERFACE® – Module 2nd Version											
	SC2	= Sine / Cosine - Module 2nd Version											
		<b>with Memorychip as of firmware V 8.35</b>											
	RM1	= Resolver + Memory- Module 2nd Version								≙ slot D			
	HM1	= HIPERFACE® + Memory- Module 2nd Version								≙ slot D			
	SM1	= Sine/Cosine + Memory- Module 2nd Version								≙ slot D			
j	Enter only when used												
	X7x	= Broad-band contact X10.7 - X10.8											
	BSx	= Moisture/Condensation Protection											

\*Only CAN2 can be employed when utilizing the option module located at slot [C], (internal BUS / COM3 B).

# 1 General Information

- Combination Possibilities for the Various Communication / I/O - Modules

Slot →	A				B										C			
Option Module →	2	4	4	C	2	2	C	C	D	S	P	I	E	P	P	E	*2	*2
Model Code ↓	3	2	8	A	C	C	C	E	U	D	B	A	C	C	A	A	C	C
	2	2	5	N	A	8	A	8	V	C	P	S	5	8	A	E	A	8
638xxxxFxSTO232000xxx	●	-	-	-	-	-	-	-	-	-	-	-	-	-	-	-	-	-
638xxxxFxSTO232EAExxx	●	-	-	-	-	-	-	-	-	-	-	-	-	-	-	●	-	-
638xxxxFxSTO2322CAxxx	●	-	-	-	-	-	-	-	-	-	-	-	-	-	-	-	●	-
638xxxxFxSTO2322C8xxx	●	-	-	-	-	-	-	-	-	-	-	-	-	-	-	-	-	●
638xxxxFxSTO422000xxx	-	●	-	-	-	-	-	-	-	-	-	-	-	-	-	-	-	-
638xxxxFxSTO422EAExxx	-	●	-	-	-	-	-	-	-	-	-	-	-	-	-	●	-	-
638xxxxFxSTO4222CAxxx	-	●	-	-	-	-	-	-	-	-	-	-	-	-	-	-	●	-
638xxxxFxSTO4222C8xxx	-	●	-	-	-	-	-	-	-	-	-	-	-	-	-	-	-	●
638xxxxFxSTO485000xxx	-	-	●	-	-	-	-	-	-	-	-	-	-	-	-	-	-	-
638xxxxFxSTO485EAExxx	-	-	●	-	-	-	-	-	-	-	-	-	-	-	-	●	-	-
638xxxxFxSTO4852CAxxx	-	-	●	-	-	-	-	-	-	-	-	-	-	-	-	-	●	-
638xxxxFxSTO4852C8xxx	-	-	●	-	-	-	-	-	-	-	-	-	-	-	-	-	-	●
638xxxxFxSTOCAN000xxx	-	-	-	●	-	-	-	-	-	-	-	-	-	-	-	-	-	-
638xxxxFxSTOCANEAExxx	-	-	-	●	-	-	-	-	-	-	-	-	-	-	-	●	-	-
638xxxxFxSTO2CA000xxx	-	-	-	-	●	-	-	-	-	-	-	-	-	-	-	-	-	-
638xxxxFxSTO2CAEAExxx	-	-	-	-	●	-	-	-	-	-	-	-	-	-	-	●	-	-
638xxxxFxSTO2C8000xxx	-	-	-	-	-	●	-	-	-	-	-	-	-	-	-	-	-	-
638xxxxFxSTO2C8EAExxx	-	-	-	-	-	●	-	-	-	-	-	-	-	-	-	●	-	-
638xxxxFxSTOCCA000xxx	-	-	-	-	-	-	●	-	-	-	-	-	-	-	-	-	-	-
638xxxxFxSTOCCAEAExxx	-	-	-	-	-	-	●	-	-	-	-	-	-	-	-	●	-	-
638xxxxFxSTOCC8000xxx	-	-	-	-	-	-	-	●	-	-	-	-	-	-	-	-	-	-
638xxxxFxSTOCC8EAE xxx	-	-	-	-	-	-	-	●	-	-	-	-	-	-	-	●	-	-
638xxxxFxSTODEV000xxx	-	-	-	-	-	-	-	-	●	-	-	-	-	-	-	-	-	-
638xxxxFxSTODEVEAExxx	-	-	-	-	-	-	-	-	●	-	-	-	-	-	-	●	-	-
638xxxxFxSTOSUC000xxx	-	-	-	-	-	-	-	-	-	●	-	-	-	-	-	●	-	-
638xxxxFxSTOSUCEAExxx	-	-	-	-	-	-	-	-	-	●	-	-	-	-	-	●	-	-
638xxxxFxSTOPDP000xxx	-	-	-	-	-	-	-	-	-	-	●	-	-	-	-	-	-	-
638xxxxFxSTOPDPEAExxx	-	-	-	-	-	-	-	-	-	-	●	-	-	-	-	●	-	-
638xxxxFxSTOPDP2CAxxx	-	-	-	-	-	-	-	-	-	-	●	-	-	-	-	-	●	-
638xxxxFxSTOPDP2C8xxx	-	-	-	-	-	-	-	-	-	-	●	-	-	-	-	-	-	●
638xxxxFxSTOIBS000xxx	-	-	-	-	-	-	-	-	-	-	-	●	-	-	-	-	-	-
638xxxxFxSTOIBSEAExxx	-	-	-	-	-	-	-	-	-	-	-	●	-	-	-	●	-	-
638xxxxFxSTOIBS2CAxxx	-	-	-	-	-	-	-	-	-	-	-	●	-	-	-	-	●	-
638xxxxFxSTOIBS2C8xxx	-	-	-	-	-	-	-	-	-	-	-	●	-	-	-	-	-	●
638xxxxFxSTOEA5000xxx	-	-	-	-	-	-	-	-	-	-	-	-	●	-	-	-	-	-
638xxxxFxSTOEA5EAExxx	-	-	-	-	-	-	-	-	-	-	-	-	●	-	-	-	-	-
638xxxxFxSTOPC8000xxx	-	-	-	-	-	-	-	-	-	-	-	-	-	●	-	●	-	-
638xxxxFxSTOPC8EAExxx	-	-	-	-	-	-	-	-	-	-	-	-	-	●	-	●	-	-
638xxxxFxSTOPCA000xxx	-	-	-	-	-	-	-	-	-	-	-	-	-	-	●	-	-	-
638xxxxFxSTOPCAEAExxx	-	-	-	-	-	-	-	-	-	-	-	-	-	-	●	●	-	-
638xxxxFxSTO000EAExxx	-	-	-	-	-	-	-	-	-	-	-	-	-	-	-	●	-	-

000 = No Option    ● Possible Combination

\* Only CAN2 can be employed when utilizing the option module located at slot [C], (internal BUS / COM3 B)

**Example:**

638A043F0STO232EAERD2

- 638 = 6th. Generation Digital Servo Drive
- A = Size A
- 04 = 4 Amps Rated Current
- 3 = 325 VDC (230 VAC)
- F = With Integrated Filter
- 0 = Without EMC - Clip
- STO = Safe Torque Off
- 232 = RS 232 Interface    ≙ on slot A
- EAE = I/O Interface 14/10    ≙ on slot C
- RD2 = Standard X30 Resolver    ≙ on slot D (Motor - Feedback system)





● **Module Slots Layout**

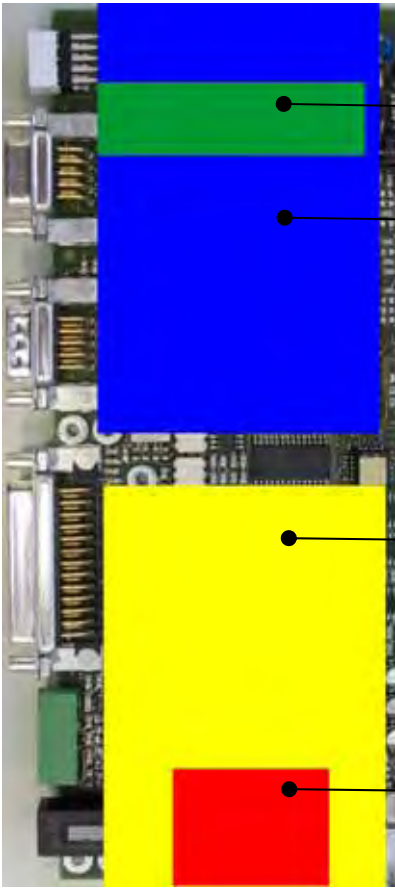

**Module Slots:**

**A** 232  
422  
485  
CAN

**B** 2CA  
2C8  
CCA  
CC8  
DEV  
SUC

PDP  
IBS  
EA5  
PCA  
PC8

**C** EAE  
\*2CA  
\*2C8

**Motor - Feedback System:**

**RD2:** Standard Resolver  
**HF2:** Option HIPERFACE®  
**SC2:** Option Sine / Cosine  
**with Memorychip as of FW V8.35**  
**RM2:** Resolver + Memory  
**HM2:** HIPERFACE® + Memory  
**SM2:** Sine/Cosine + Memory

● **Module Design**

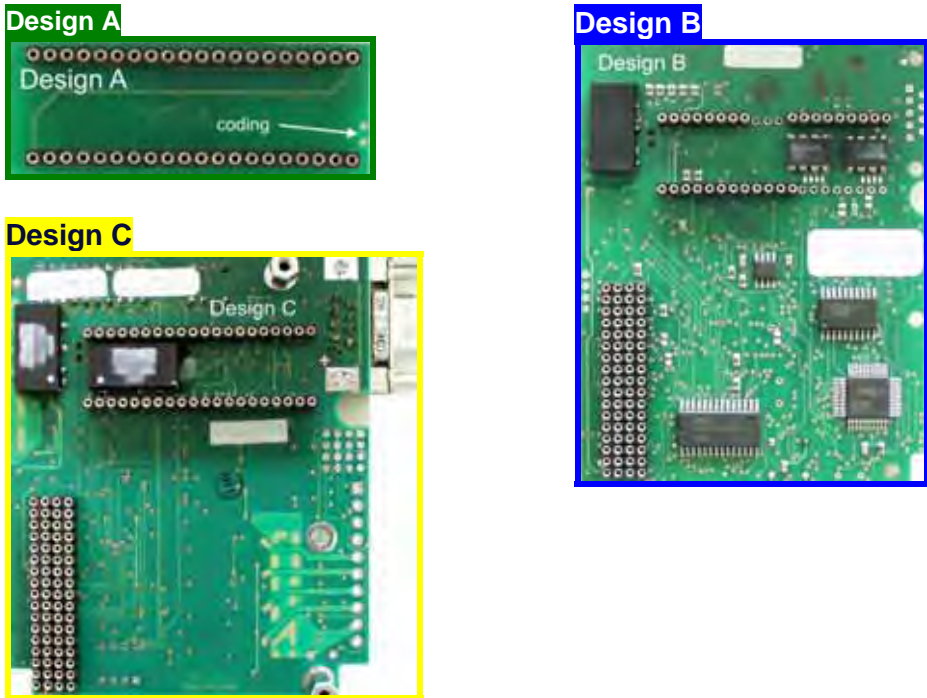

**Design A**

Design A  
coding

**Design B**

Design B

**Design C**

Design C

# 1 General Information

## 1.3 Dimensions

- 638A Series

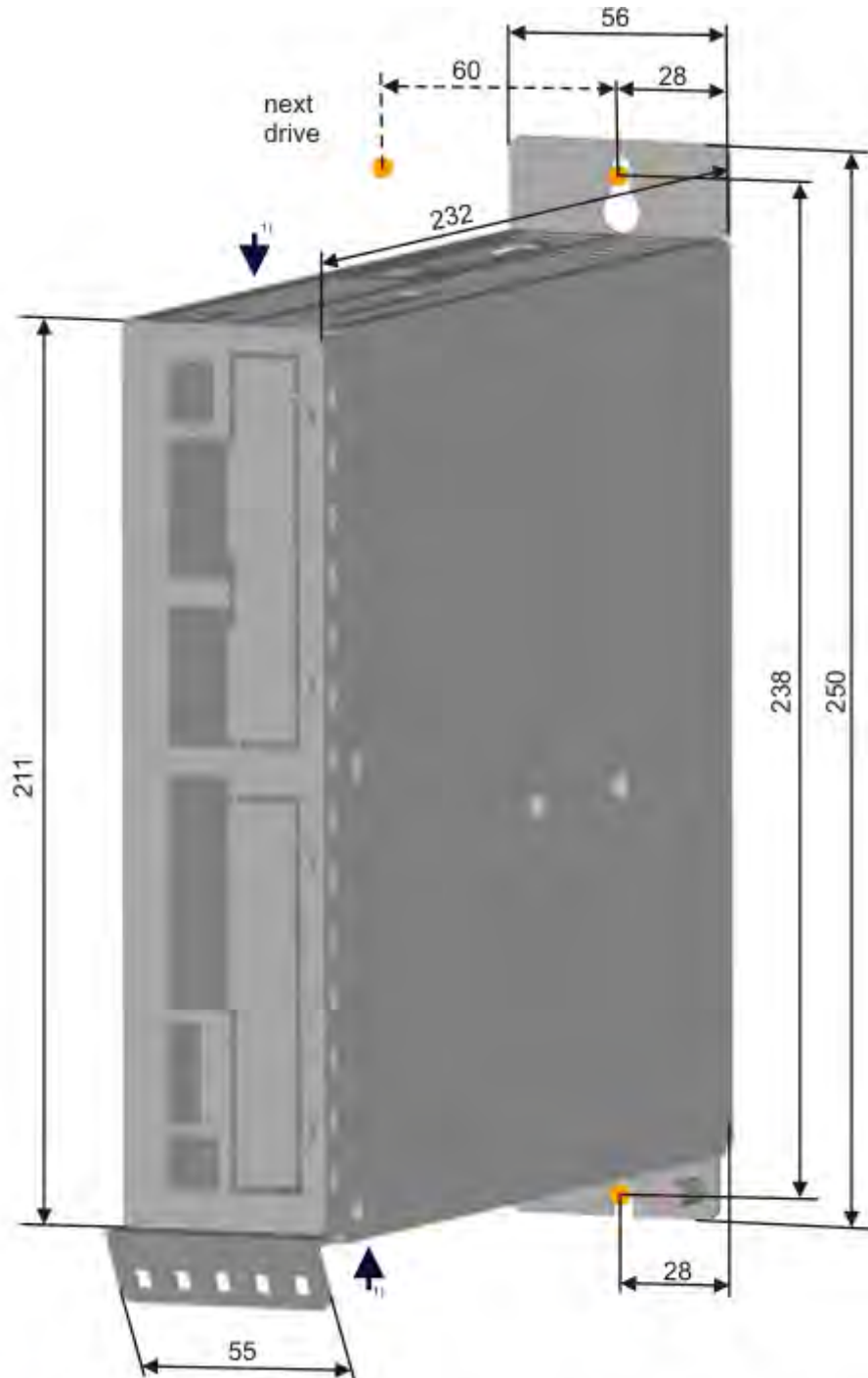

● 2 x M5 mounting screw

▲ For sufficient air circulation you must have an expansion space of 100 mm on the inlet- and outlet-cooling

### **Important:**

- Please note that on the front side of the unit, approximately 70 mm of additional space is required for the signal mating plugs!
- When installing multiple servo drives, there is minimum space on the side.
- The unit should only be mounted vertically as shown.



- 638B Series

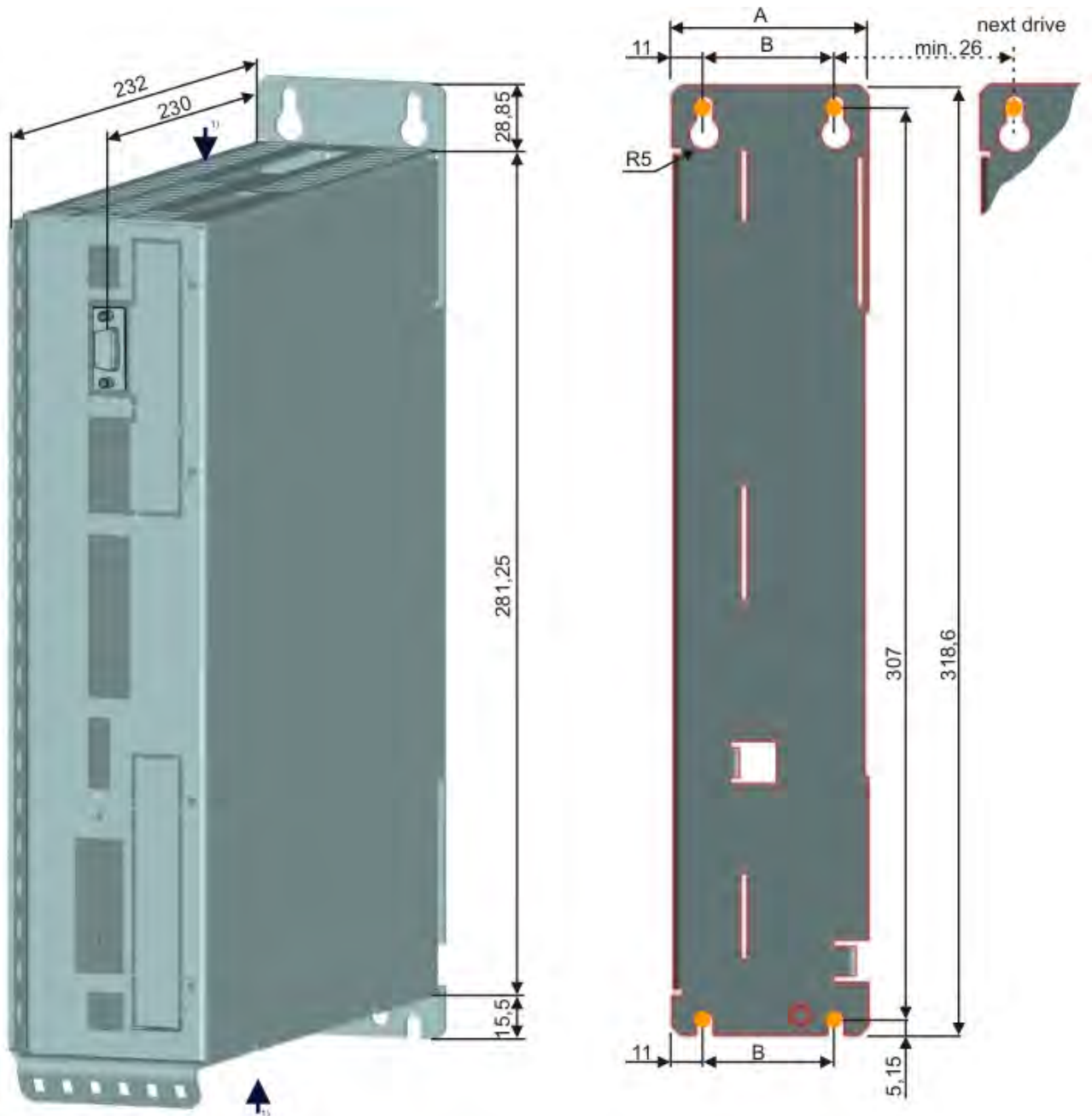

● 4 x M5 mounting screw

▲ For sufficient air circulation you must have an expansion space from 100mm minimum on the inlet- and outlet-cooling

A = 66mm for 638B03.. and 638B05..  
= 86mm for 638B08.. ; 638B10.. and 638B15..

B = 44mm for 638B03.. and 638B05..  
= 64mm for 638B08.. ; 638B10.. and 638B15..

**Important:**

- Please note that on the front side of the unit, approximately 70 mm of additional space is required for the signal mating plugs!
- When installing multiple servo drives, there is minimum space on the side.
- The unit should only be mounted vertically as shown.

## 2 Connection Assignments and Functions

### 2.1 Insulation Concept

The insulation of the 638 units is achieved in various insulation classes or groups.

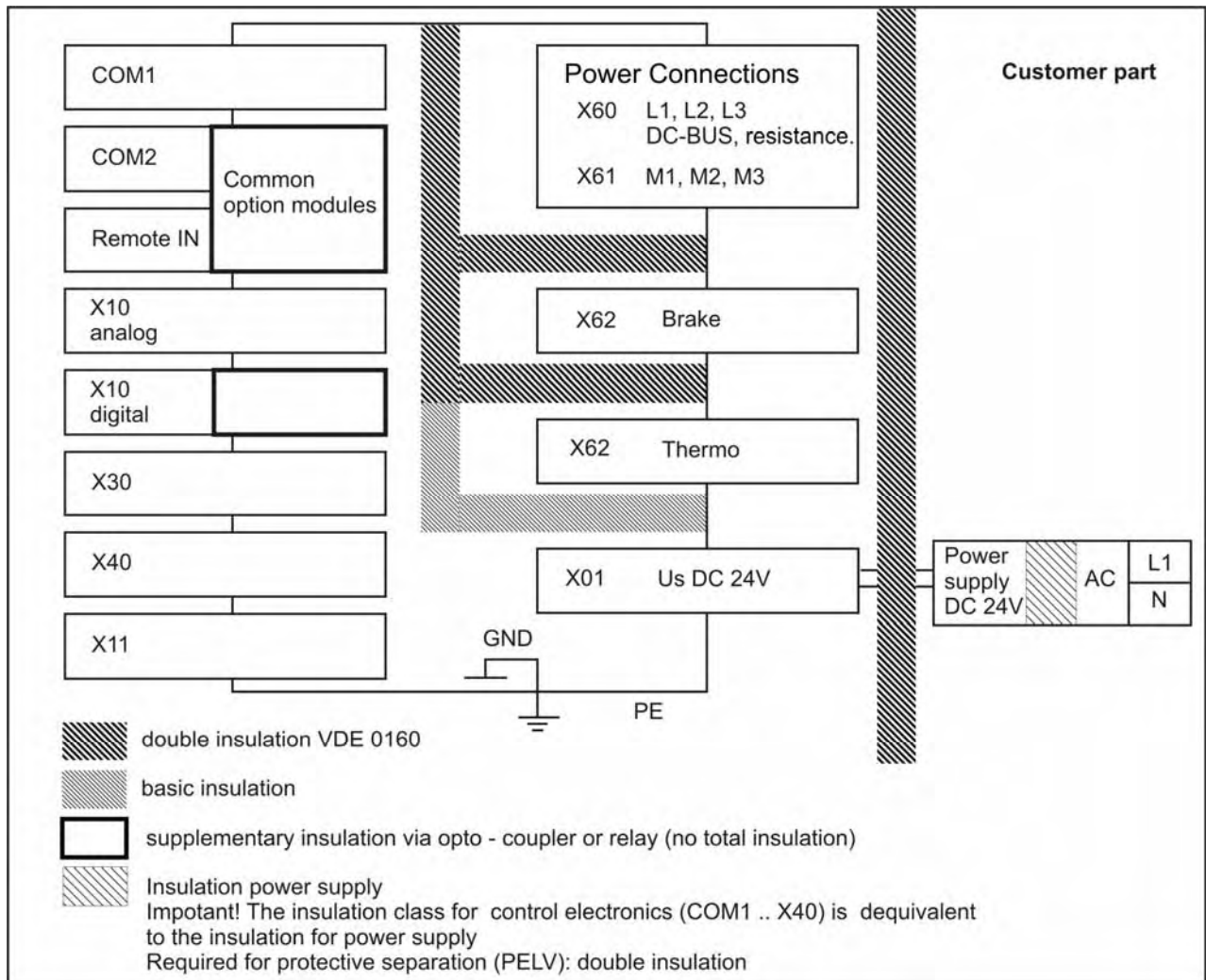

## 2

# Connection Assignments and Functions

## 2.2 Overview of Compact Unit Connections

- 638A01.. to 638A06..

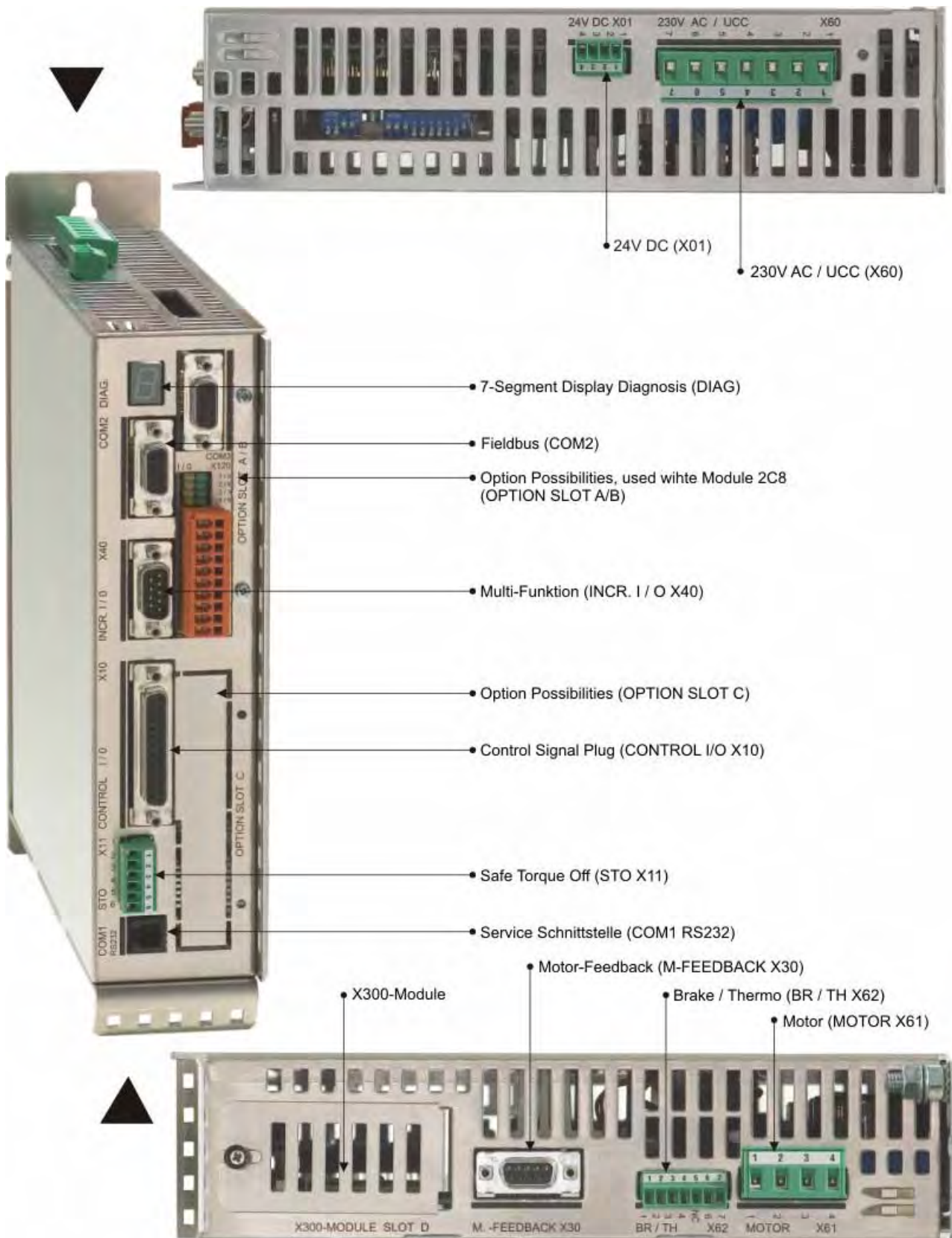



## 2 Connection Assignments and Functions

- 638B03.. to 638B15..

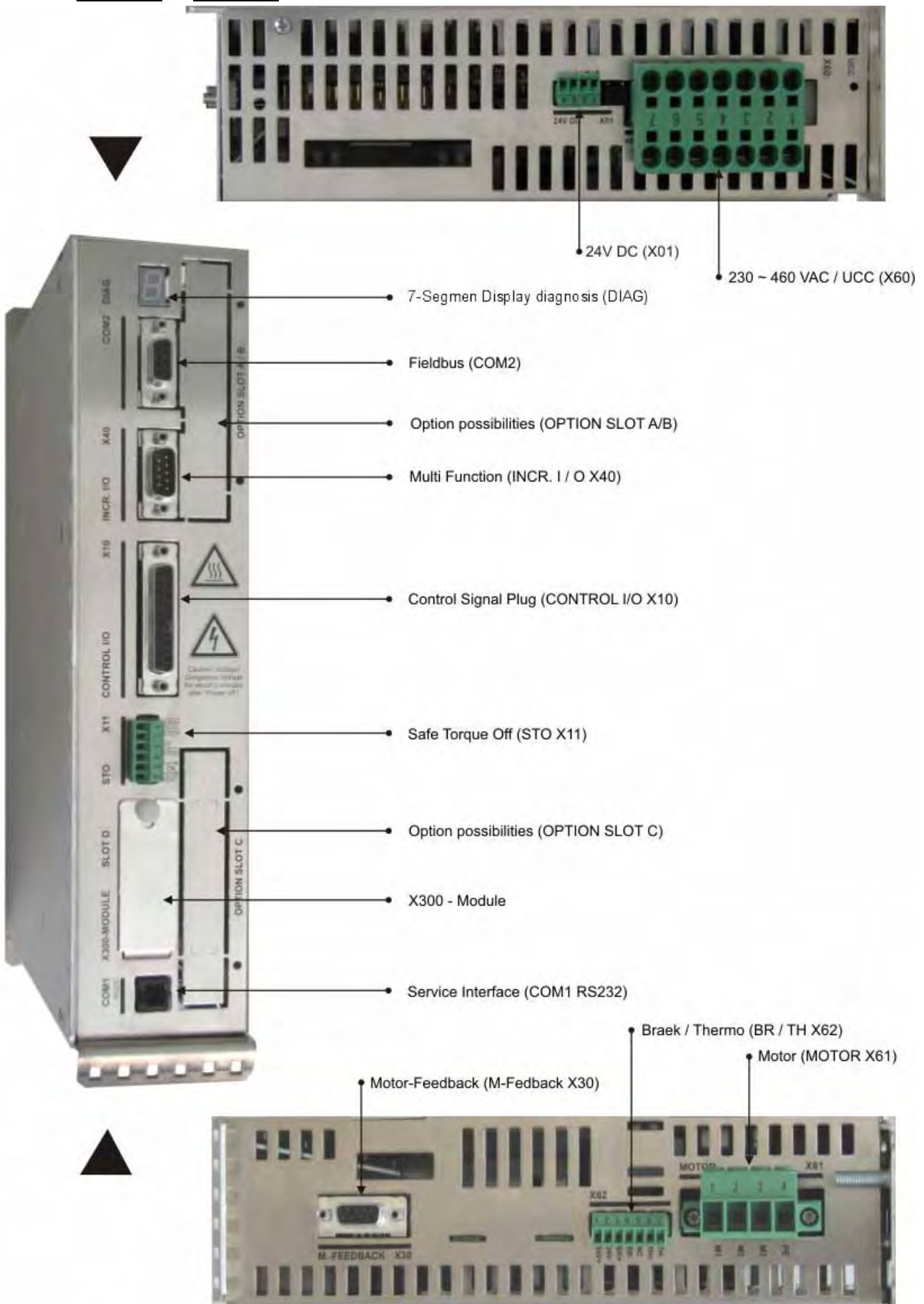

## 2

# Connection Assignments and Functions

### 2.3 Assignments Power Connections

- **Power, Ballast, DC Bus - Connection X60**

638A Plug - X60		
PIN	Designation	Function
1	0VP	0 Volt DC Bus
2	RB1/+UCC	External – Ballast Resistor / + DC - Bus
3	RB2	External – Ballast Resistor
4	L1	Power Connection 1, 230V AC
5	L2	Power Connection 2, 230V AC
6	L3 / N	Power Connection 3, 230V AC / Ground
7	PE	Protective Ground



638B Plug - X60		
PIN	Designation	Function
1	0VP	0 Volt DC Bus
2	RB1/+UCC	External – Ballast Resistor / + DC - Bus
3	RB2	External – Ballast Resistor
4	L1	Power Connection 1, 400V AC
5	L2	Power Connection 2, 400V AC
6	L3	Power Connection 3, 400V AC / Ground
7	PE	Protective Ground

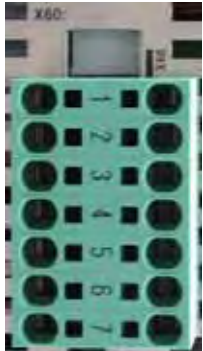

- **24V - Control Supply Voltage X01**

Plug - X01		
PIN	Designation	Function
1	+24V	Supply Us (Input)
2	+24V	Supply Us (Output with PIN 1 jumpered)
3	0V	Reference Potential 0V
4	0V	Reference Potential 0V



[Setup and Wiring example](#)

- **Motor - Connection X61**

Plug - X61		
PIN	Designation	Function
1	M1 / U	Motor Supply
2	M2 / V	Motor Supply
3	M3 / W	Motor Supply
4	PE	Protective Ground

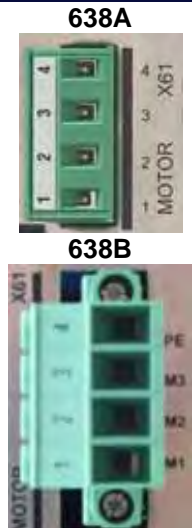

## 2 Connection Assignments and Functions

- Brake / Thermo - Connection **X62**

Stecker - X62			
PIN	Bezeichnung	Funktion	
1	+24V	Input; Supply Voltage Mechanical Brake	
2	0V	Input; Refer. Potential Supply Voltage Mechanical Brake	
3	BR+	Control Mechanical Brake	
4	BR-	Control Mechanical Brake	
5	-	Not assigned	
6	TH+	Thermo PTC <sup>1)</sup> /NTC	<a href="#">Setup and Wiring example</a>
7	TH-	Thermo PTC <sup>1)</sup> /NTC	



- <sup>1)</sup> With parameter setting PTC can you temperature sensor Typ KTY (note poling) or thermo switch used.  
 EASYRIDER Menu „Configuration Motor / X30 **Switch off at:**“ use resistor value in Ohm.  
 For thermo switch is the value 1000 Ohm in the EASYRIDER Menu „Configuration Motor / X30 **Switch off at:**“

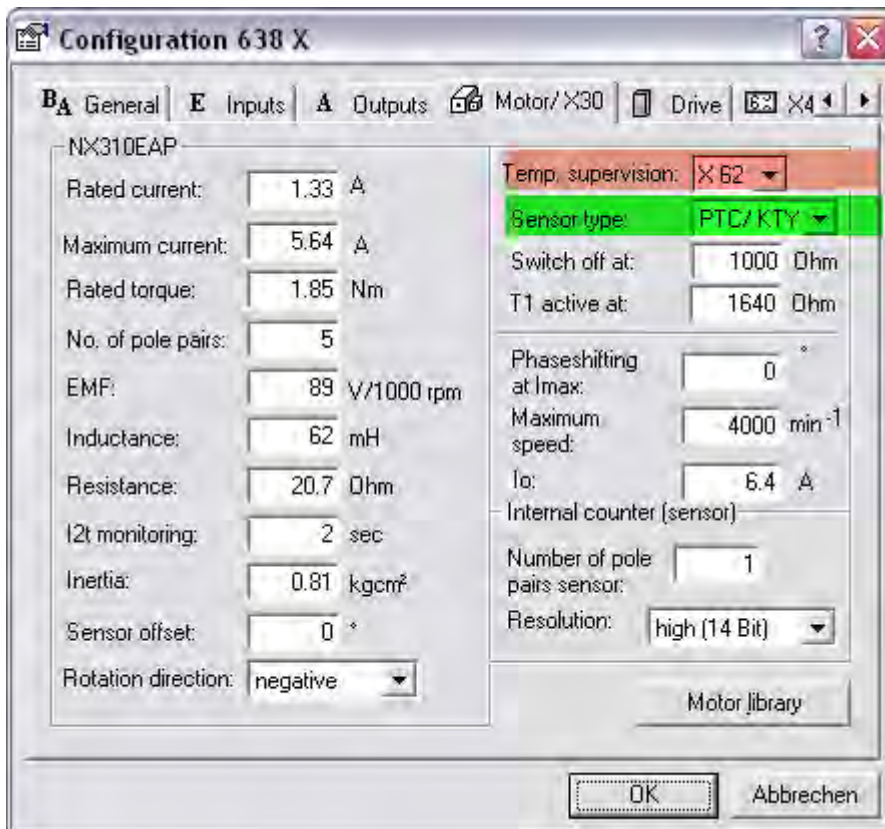

2.4 Feedback Sensor X30

The feedback system creates a digital value from the feedback position sensor.

**From this value the following is derived:**

- Commutation according to the pole division
- Actual rotational speed value
- Position value for the position controller

● **Feedback - Module X300**

The X30 connection is directly connected to the Feedback - Module X300. The mode of operation of the feedback system is specified by this plug-in module. (see: ● [Layout Module Slots](#)) The 638 – Drive system therefore offers a built-in flexibility and provides for the possibility of future modification.

638A



638B

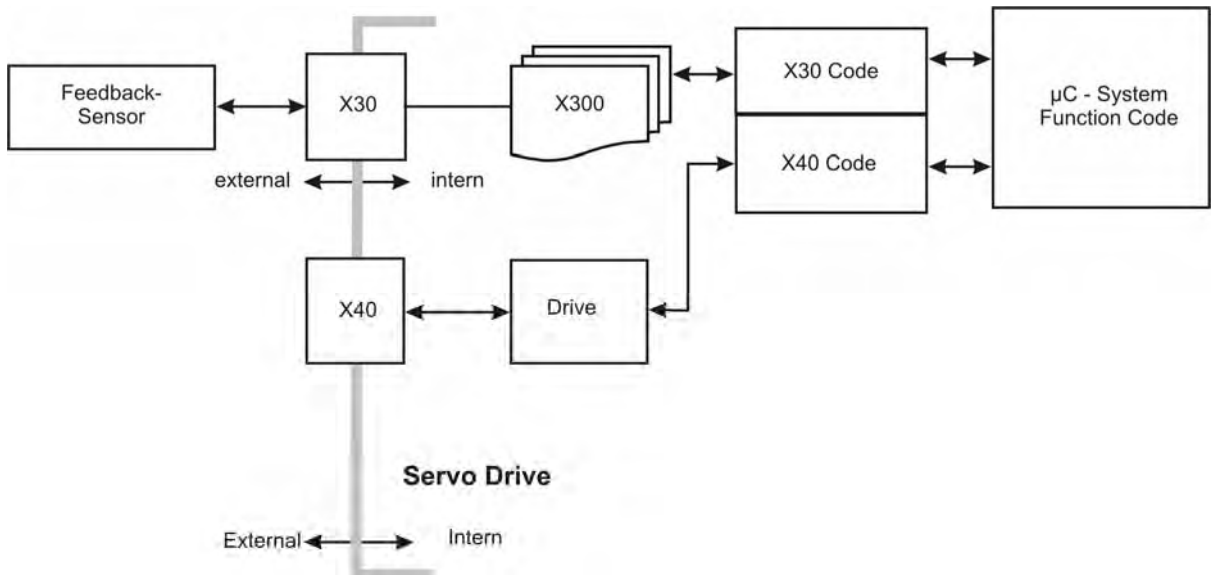

Model Type X300	Description	
X300_RD2	Resolver	Standard
X300_HF2	HIPERFACE®	Option
X300_SC2	Sine/Cosine	Option
X300_RM1	Resolver + Memory	Option as of Firmware V 8.35
X300_HM1	HIPERFACE® + Memory	Option as of Firmware V 8.35
X300_SM1	Sine/Cosine + Memory	Option as of Firmware V 8.35
Additional types available upon request.		

**Plug and Play**

The 638 Servo Drive is able to identify the type of X300 Module employed. The EASYRIDER® Windows – Software loads the correct function code. You follow the instructions in the EASYRIDER® Windows – Software. For feedback module RD2 the function code is already pre-set (factory default).

**Note**

When employing the Feedback Module X300\_HF2 (HIPERFACE®), please pay attention to documentation 07-02-09-02-E-Vxx.



## 2 Connection Assignments and Functions

- **Feedback Connection X30 (SUB D 09 Socket)**  
Pinning for the Motor - Feedback - Socket X30 when employed with:

Resolver Module X300\_RD2 or X300-RM1(Standard Module)

Module: X300_RD2 / X300_RM1	
PIN X30	Function
1	-
2	PTC <sup>1)</sup> / NTC optional
3	cos +
4	sin +
5	carrier +
6	PTC <sup>1)</sup> / NTC optional
7	cos -
8	sin -
9	carrier -



[Setup and Wiring example](#)

- <sup>1)</sup> With parameter setting PTC can you temperature sensor Typ KTY (note poling) or thermo switch used.  
EASYSRIDER Menu „Configuration Motor / X30 **Switch off at:**“ use resistor value in Ohm. For thermo switch is the value 1000 Ohm in the EASYSRIDER Menu „Configuration Motor / X30 **Switch off at:**“

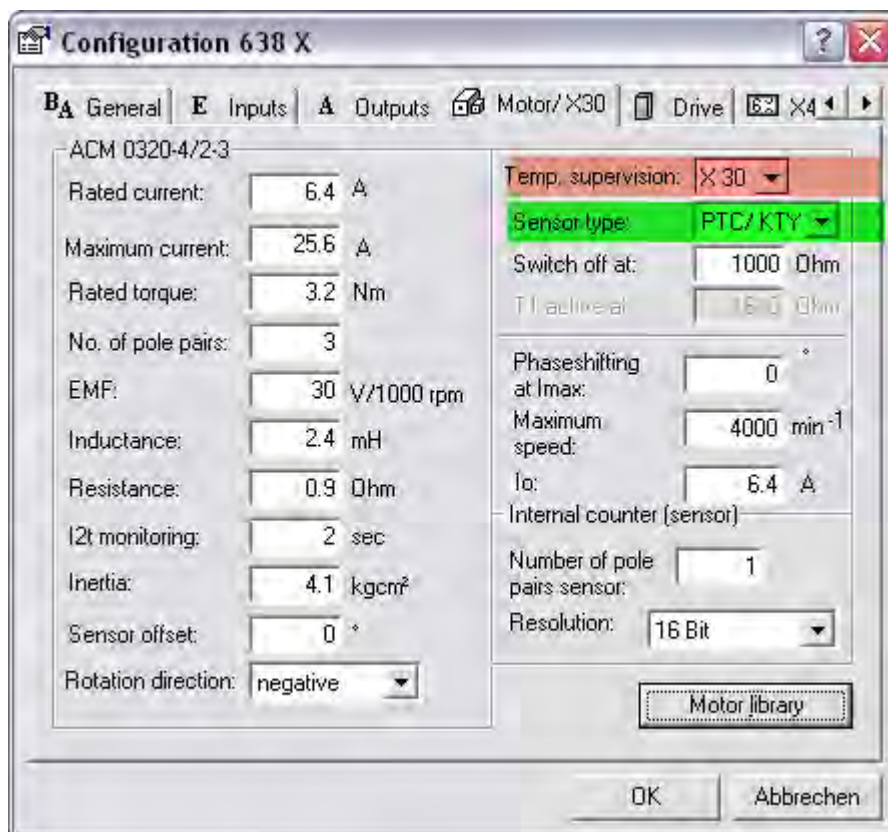



HIPERFACE® - Module X300\_HF2 or X300\_HM1

Module: X300_HF2 / X300_HM1	
PIN X30	Function
1	GND
2	10 VDC
3	cos +
4	sin +
5	data -
6	-
7	ref cos
8	ref sin
9	data +



Sine / Cosine - Module X300\_SC2 or X300\_SM1

Module: X300_SC2 / X300_SM1	
PIN X30	Function
1	GND
2	5,5 V
3	cos +
4	sin +
5	zero pulse -
6	-
7	ref cos
8	ref sin
9	zero pulse +



● **Feedback - Module X300 with Memory**

As of firmware version V8.35 the 638 Drive supports the X300-xM-Modules.  
 This module has an additional memory chip (Flash).  
 This flash stores the complete drive data. (firmware, function code, parameters, application program)  
 When a drive is defect the X300-memory module can be replaced with the complete drive data in the new drive.  
 You need no additional configuration work or software tools.  
 Requirement: The drive type must be equal (same current)!

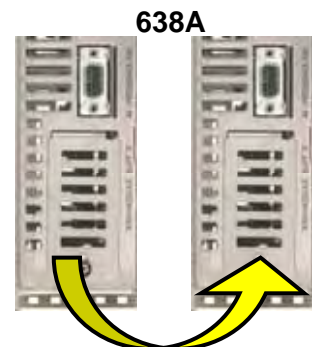

	<p><b>Attention during the 1.st switch on of the control voltage after the X300 module replacement!</b>                  After the replacement of the X300 module, make sure that the 1st switch on of the 24V control voltage has no interruption during 60 seconds.                  (It is necessary that the copy program for Firmware and X300 Feedback function code are not interrupted.)</p>
---	--



	<p><b>Applications in Accordance with the Regulations</b>                  When the 638A Drive supports the safety function "Safe Torque Off", in the sense of providing a definitive stopping of the equipment, with protection against unanticipated start-up, in accordance with regulations EN954-1, Category 3 and EN, after the X300 module change one must follow the instructions completely as stated in the validation report.</p>
---	--

## 2 Connection Assignments and Functions

### 2.5 Service-Interface COM1 (RS232)

**Functions:**

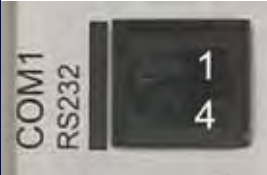
- Supports all diagnostic and parameter configuration activities
- PC connection utilizing our communications cable KnPC/D
- Communication utilizing our operational program software (EASYRIDER® Windows - Software)

Com 1 RS232	PIN	Function Drive Side	PIN	RS232 on PC
4-Pin Modular Plug 				
RXD	1	Receive Serial Data	3	TXD
TXD	2	Send Serial Data	2	RXD
	3	Do Not Connect		
GND	4	Ground	5	GND

Order code	Length	Description
KnPC637+/631-03.0	3 m	PC-Side Sub D 09-Plug
KnPC637+/631-05.0	5 m	Drive-Side 4-Pin RJ 10-Plug



**Note:**

The service interface port is not galvanically separated and should therefore not be used as the operations interface port (fixed wiring)!  
 The network connection with the PC must be located near the Drive in order to receive the reference potentials of the units together.

## 2

# Connection Assignments and Functions

## 2.6 Safe Torque Off

- **Connection Safe Torque Off X11**

Plug - X11		
PIN	Description	Function
1	STO1 #	Channel 1 (ACTIVE_STO1)
2	STO1 #	Channel 1 (ACTIVE_STO1) Parallel to PIN 1
3	0V / PE	Reference Potential 0V
4	STO2 #	Channel 2 (ACTIVE_STO2)
5	-	Ready potential-free contact assembly
6	-	Ready potential-free contact assembly



Further description of this function can be found in Chapter **“Safe Torque Off” (STO)**

- **Connection WITHOUT the utilization of the Safe Torque Off, (STO), function**

	PIN	Description
Input ACTIVE (24V)	1	STO1 #
	2	STO1 #
0VSPS	3	0V / PE
	4	STO2 #
	5	-
	6	-

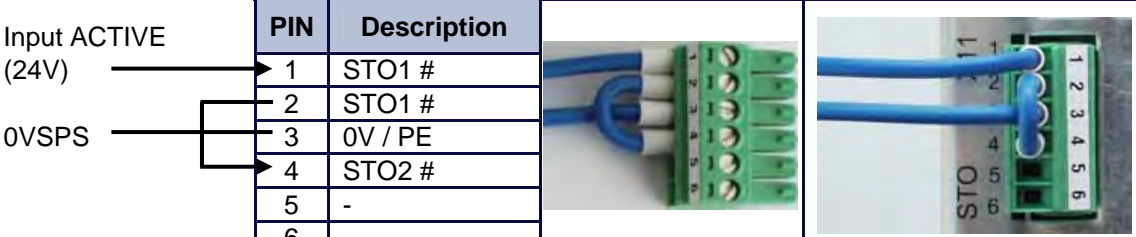

The control supply voltage must be definitively separated, in accordance to regulation EN 1578

## 2 Connection Assignments and Functions

### 2.7 Signal Connection

- Control Signal Plug X10 (SUB D25 Socket)

#### Inputs / Outputs

Control Signal Plug X10			
PIN X10	Function	Type	Description
1	Shielding Connection		Screen
2	Configurable (Operating Mode)	OPTO	Input
3	Stabilized Auxiliary Supply Voltage -12VDC; max. 80 mA		Output Auxiliary Supply Voltage
4	Configurable (Operating Mode)	OPTO	Input
5	Reference Point to X10.18		Input Analog 0...+/-10V / Ri = 10 kOhm
6	Configurable	-	Output Analog
7	Through JP100 (soldered jumper) assignable as a free and loopable potential for the READY Contacts		Optional
8	ON: Drive trouble free OFF: Drive problem or power supply interruption	Relays	Output Constant: Ready
9	Reference Point for Digital Input		Reference Point for Digital Inputs
10	Ground for Analog Signal		Ground
11	Configurable (Operating Mode)	OPTO	Input
12	Configurable (Operating Mode)	OPTO	Output
13	Configurable (Operating Mode)	OPTO	Output
14	Configurable (Operating Mode)	OPTO	Input
15	Configurable (Operating Mode)	OPTO	Input
16	Stabilized Auxiliary Supply Voltage +12V DC; max 80 mA		Output Auxiliary Supply Voltage
17	Configurable	-	Output Analog
18	Rotational Speed Setpoint; Scaleable differential with respect to X10.5		Input Analog 0...+/-10V / Ri = 10 kOhm
19	Specifications for the Power Limits - can be activated and are scaleable (0..+10V for 0.. I <sub>max</sub> )		Input Analog 0..+10V Ri = 10 kOhm
20	Configurable (Operating Mode)	OPTO	Output
21	Nominal: 24VDC		Supply for Outputs
22	Configurable (Safety Functions)	OPTO	Input
23	-	-	-
24	Configurable (Operating Mode)	OPTO	Input
25	Configurable (Operating Mode)	OPTO	Input

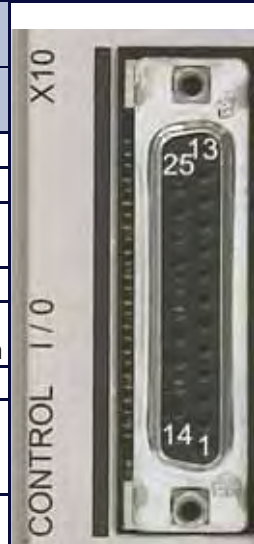

Data for the digital in and outputs: See Chapter. “[General Technical Data](#)“

### 2.8 Multi-Function X40

#### Description of the X40:

Via a programmable I/O processor, the X40 connection can be configured differently.

EASYSRIDER® Windows - Software

Standard functions:

- Incremental output
- Incremental input
- Stepper motor - pulse inputs
- SSI interface

The unobstructed configurability provides ideal conditions for synchronous applications.

General Data	X40
Plug Type:	SUB D 09 male plug
Maximum Input or Output Frequency:	312 kHz
Maximum Cable Length - connected to galvanically insulated terminals (Encoder, controls)	25 m; For extended distances please contact our engineer
Maximum Cable Length - connected to ground related terminals (other drives, controls)	2 m, Pay attention to provide for good common grounding !
Maximum Number of Signal Inputs - to one as incremental output configured device	8
Output Signals:	Driver Model MAX483 or compatible, RS422
Differential Logic Level:	L $\leq$ 0,5V      H $\geq$ 2,5V
Nominal Range:	0,0 ... 5,0V      150mA max.
Input Signals:	Receiver Model MAX481 or compatible, RS422
Differential Input Level:	Diff min = 0,2V
Nominal Signal Difference:	1,0V
Current Consumption:	1...4 mA (depending on the frequency)

#### Notice:

Master / Slave Operation

1 Master, Maximum 8 Slaves

Condition: Devices must be located directly side by side!

## 2 Connection Assignments and Functions

- **Incremental - Output**

EASYRIDER® Windows - X40 Connection: Mode = Incremental Output

Incremental encoder simulation for processing in positioning modules

Standard: 1024 increments with Pulse Duty Cycle

Additional selectable pulse settings: 16384, 8192, 4096, 2048, 512, 256, 128, 64

Inc. I/O X40		
PIN X40	Function	Designation
1	Channel B	B
2	Channel B - Inverted	/B
3	Shield Connector	Shield
4	Channel A	A
5	Channel A - Inverted	/A
6	Reference *	GND
7	Channel Z - Inverted Zero Impulse	/Z
8	Channel Z, zero impulse	Z
9	Supply Voltage Output Max. 150 mA	+ 5 VDC



Pulse resolution	Max. permissible speed
≥1024 Incr./rpm	12000 rpm
2048 Incr./rpm	7600 rpm
4096 Incr./rpm	3800 rpm
8192 Incr./rpm	1900 rpm
16384 Incr./rpm	950 rpm

**Design Rule:**

The input frequency range of the connected control must equal at least the value of the pulse output frequency on the X40.

n = max. speed (rpm)  
 x = increments e.g. 1024  
 f = output frequency at X40.1,2,4,5

**Formula:**  $f = \frac{1,2 * (n * x)}{60} = [\text{Hz}]$

**Example:** n = 4000 1/min

$f = \frac{1,2 * (4000 * 1024)}{60} = 81920 \text{ Hz}$

- **Incremental - Input**

EASYRIDER® Windows - Software X40 Connection: Mode = Incremental Input

Parameter range of the input signals: 10...1000000 increments

**Figure:**

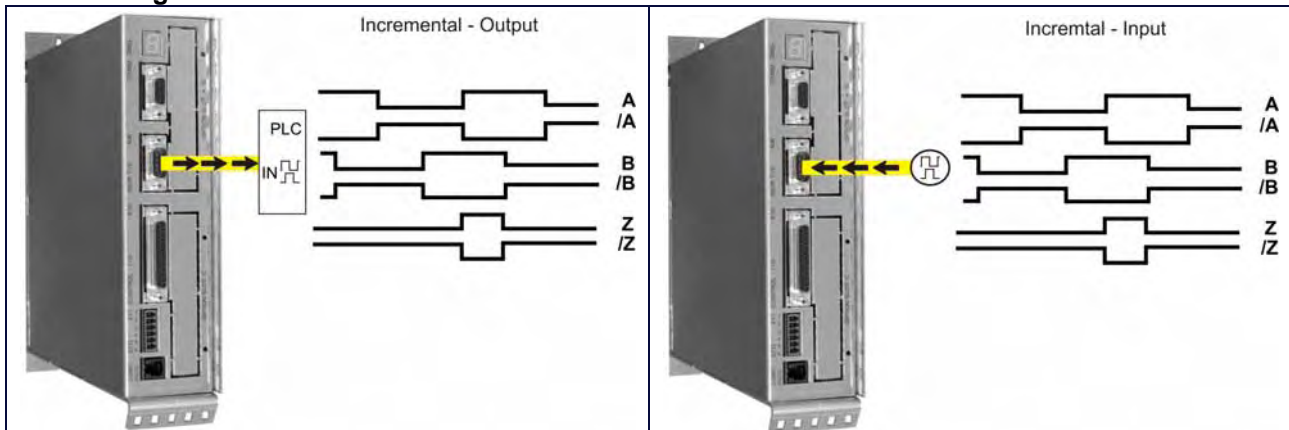

**Note:**

The operation of incremental encoders via long cables may cause a voltage drop of the encoder power supply. We recommend the use of a separate voltage supply if necessary.



- Stepper Motor Input**

Two different modes are available

EASYRIDER® Windows - Software X40 Connection: Mode = Stepper Motor (Pulse+Direction)

EASYRIDER® Windows - Software X40 Connection: Mode = Stepper Motor (2\*Pulse)

INCR. I/O X40			
PIN X40	Function		Designation
	Mode: Pulse+Direction	Mode: 2*Pulse	
1	Output: Drive Active - Inverted		/READY
2	Output: Drive Active		READY
3	Shield Connector		Shield
4	Pulse Inverted	Pulse - Inverted	-
5	Pulse	Pulse -	-
6	Reference Potential (generally to connect)		GND
7	Direction Inverted	Pulse + Inverted	-
8	Direction	Pulse +	-
9	Supply Voltage Output Max. 150 mA		+5 VDC



**Figure: Pulse+Direction**

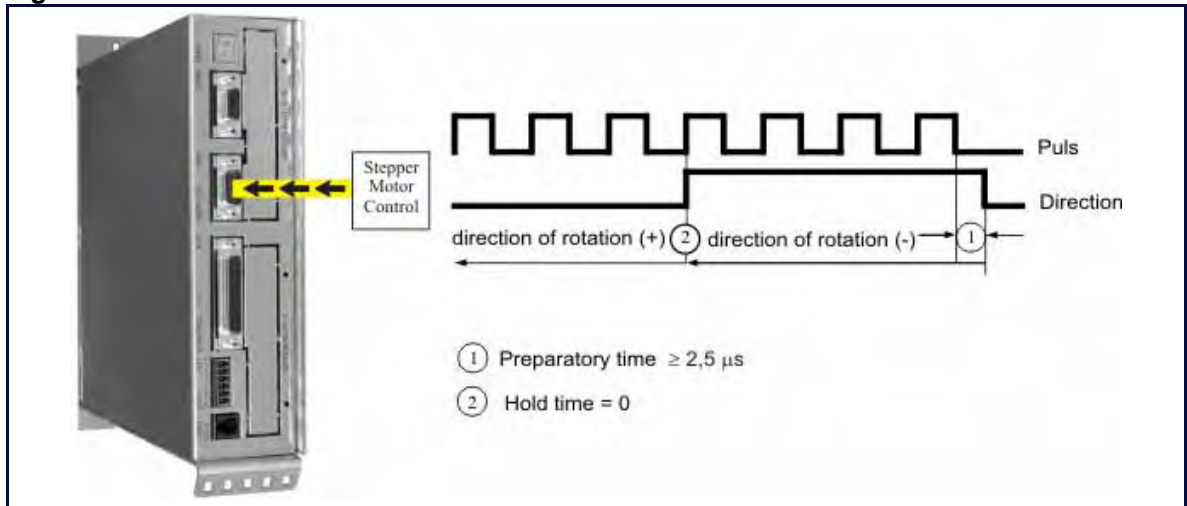

**Figure: 2\*Pulse**

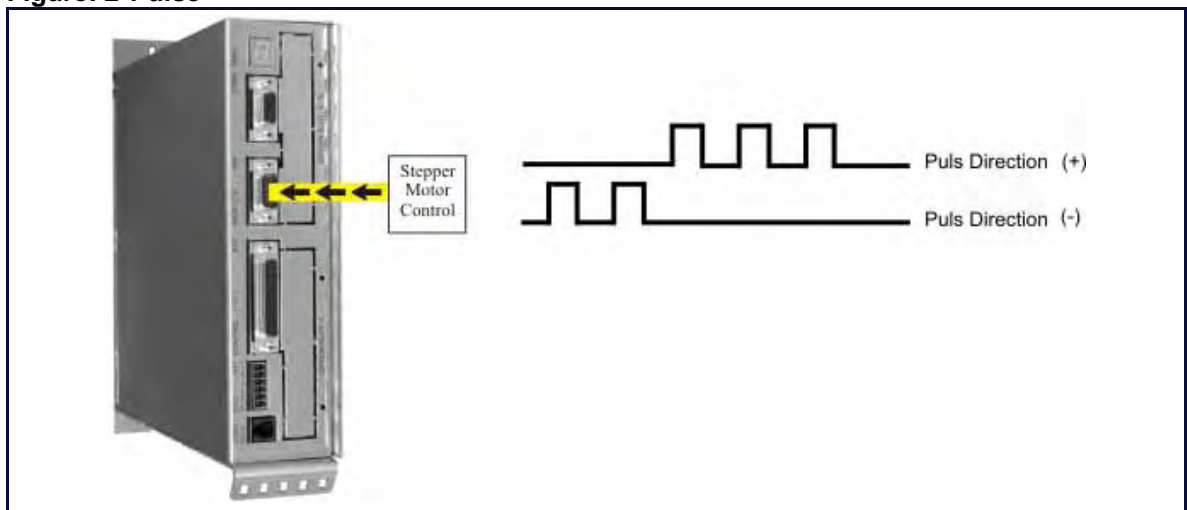

## 2 Connection Assignments and Functions

- **SSI-Encoder Interface**

EASYSRIDER® Windows – Software

- X40 Connection: Modus = SSI\_13 Bit Singleturn Input
- X40 Connection: Modus = SSI\_14 Bit Singleturn Input
- X40 Connection: Modus = SSI\_25 Bit Multiturn Input / (13 Bit Single- / 12 Bit Multiturn)
- X40 Connection: Modus = SSI\_26 Bit Multiturn Input / (14 Bit Single- / 12 Bit Multiturn)
- X40 Connection: Modus = SSI\_18 Bit Multiturn Input / (16 Bit Single- / 2 Bit Multiturn)

Incr. I/O X40		
PIN X40	Function	Designation
1	Serial Data from SSI Encoder, GRAY Code up to 26 Bit - Inverted	/DATA
2	Serial Data from SSI Encoder, GRAY Code up to 26 Bit	DATA
3	Shield Connector	Shield
4	Clock Output - Inverted Standard Frequency: 179 kHz	/TAKT
5	Clock Output Standard Frequency: 179 kHz	TAKT
6	Reference Potential	GND
7	Do Not Connect	
8	Do Not Connect	
9	Supply Voltage Output Max. 150 mA <b>If other data required:</b> a) Use of X300 Module b) External Supply	+5 VDC



TAKT and /TAKT twisted pairs  
 DATA and /DATA twisted pairs  
 Cable Shielded - shielding grounded at both ends,  
 Max. Cable Length: 200m

**Note:**

For further information about SSI (Synchronous Serial Interface), please refer to the documentation of the appropriate suppliers. (e.g.: Comp. Sick or Hengstler)

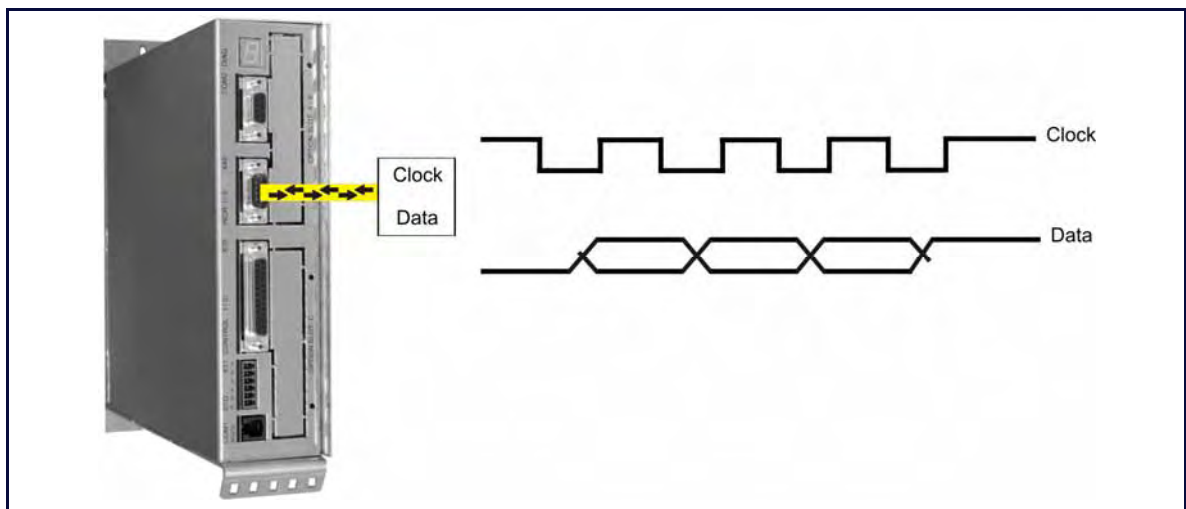



## 2.9 Fieldbus Interface COM2

Additional functions can be realized through the optional employment of the **Options Modules**

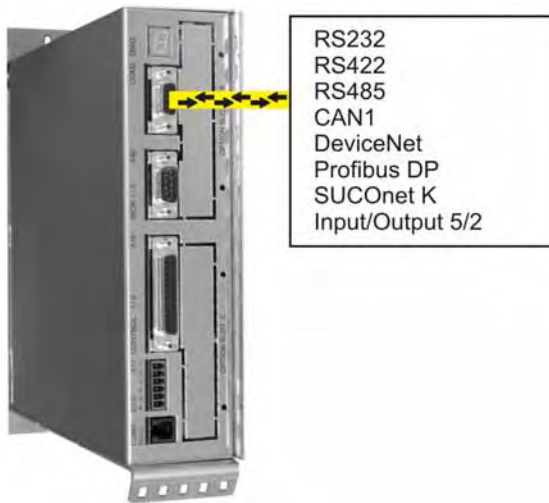

- **Pinning for RS232**

Module: RP 232	
PIN	Function
1	-
2	RXD
3	TXD
4	-
5	GND / 485-GND
6	-
7	-
8	-
9	-



- **Pinning for RS422/485**

Module: RP 422 oder RP 485	
PIN	Function
1	-
2	-
3	-
4	Data In
5	GND
6	Data In - Inverted
7	Data Out - Inverted
8	Data Out
9	-



Options module **RP 422**, without galvanic separation  
 Options module **RP 485**, with galvanic separation  
 Parallel wiring for up to 16 units. (Full - Duplex, 4-Wire)

## 2 Connection Assignments and Functions

- **Pinning for CAN or DeviceNet**

Module: RP CAN (CAN BUS1) or RP DEV		
PIN	Function	Designation
1	-	-
2	CAN_L Bus Line (dominant low)	CAN_L
3	Ground	CAN-GND
4	-	-
5	-	-
6	Optional Ground	CAN-GND
7	CAN_H Bus Line (dominant high)	CAN_H
8	-	-
9	-	-



with galvanic separation

- **Pinning for Profibus DP**

Module: RP DP		
PIN	Function	Designation
1	-	-
2	-	-
3	Line B	B
4	Request to Send	RTS
5	Ground	PDP-GND
6	Potential +5V	+5V
7	-	-
8	Line A	A
9	-	-



with galvanic separation

- **Pinning for SUConet K**

Module: RP SUC		
PIN	Function	Designation
1	-	-
2	-	-
3	Data Line +	TA/RA
4	-	-
5	Signal Ground	SGND
6	-	-
7	Data Line -	TB/RB
8	-	-
9	-	-



with galvanic separation

## 2

# Connection Assignments and Functions

- **Pinning for EA5 I/O-Interface (Digital In and Outputs)**

Module: RP EA5			
PIN	Function	Designation	Status
1	BIAS Input 101	Standard	Input
2	BIAS Input 102	Standard	Input
3	BIAS Input 107	Standard	Input
4	BIAS Input 108	Standard	Input
5	0VSPS	Ground reference 0VSPS	B
6	BIAS Input 106	Standard	Input
7	BIAS Output 109	Standard	Output
8	BIAS Output 110	Standard	A
9	+24VSPS	Ext. +24V feed-in	UB



with galvanic separation

**Notice !**

The inputs with the internal numbers 107 and 108 must be connected to pin numbers 3 and 4.  
The outputs with the internal numbers 109 and 110 must be connected to pin numbers 7 and 8.

## 2 Connection Assignments and Functions

### 2.10 Fieldbus Interface **COM2** in Combination with **COM3** (OPTION SLOT A/B)

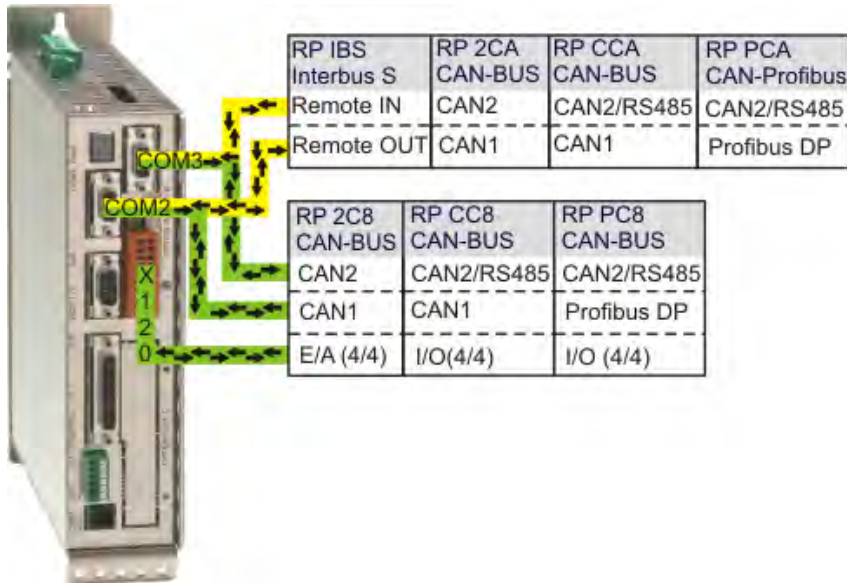

- **Pinning for Interbus S (RP IBS)**

Remote OUT - Outgoing Interface (SUB D09 Socket)

Module: RP IBS		
PIN	Function	Designation
1	Data Line OUT Forward (error voltage A)	DO2
2	Data Line IN Backward (error voltage A)	DI2
3	Reference Potential	IBS-GND
4	-	-
5	VCCI	+5V
6	Data Line OUT Forward (error voltage B)	/DO2
7	Data Line IN Backward (error voltage B)	/DI2
8	-	-
9	Reporting Input *	RBST



\* for additional Interbus S - Interfaces

Remote IN - Incoming Interface (SUB D09 Plug)

Module: RP IBS		
PIN	Function	Designation
1	Data Line IN Forward (error voltage A)	DO1
2	Data Line OUT Backward (error voltage A)	DI1
3	Reference Potential	IBS-GND
4	-	-
5	-	-
6	Data Line IN Forward (error voltage B)	/DO1
7	Data Line OUT Backward (error voltage B)	/DI1
8	-	-
9	-	-





with galvanic isolation

## 2

# Connection Assignments and Functions

### 2.11 Fieldbus Interface RP 2CA, 2C8

- Pinning CAN1-BUS and CAN2-BUS

Module: RP 2CA, 2C8			CAN1	CAN2
PIN	Function	Designation		
1	-	-		
2	CAN_L Bus Line (dominant low)	CAN_L		
3	Ground	CAN-GND		
4	-	-		
5	-	-		
6	Optional Ground	CAN-GND		
7	CAN_H Bus Line (dominant high)	CAN_H		
8	-	-		
9	-	-		

with galvanic isolation

- Pinning RP 2C8 X120 (with I/O's)

X120	Function		BIAS PIN	Status	
	0	1			
1	BIAS	Reset Drive Fault	Input 121	Input	
2	BIAS	Limit Switch +	Input 122	Input	
3	BIAS	Limit Switch -	Input 123	Input	
4	BIAS	Reference Switch	Input 124	Input	
5	BIAS	Cam 1	Output 125	Output	
6	BIAS	Cam 2	Output 126	Output	
7	BIAS	Cam 3	Output 127	Output	
8	BIAS	Cam 4	Output 128	Output	
9	Ext. +24 V Supply		-	Ub	
10	Ground Reference 0 V		-	B	

The signal status of the I/O's is shown with a 2mm LED  
 LED on I/O = high / LED off I/O = low.  
 (min./max. cable cross-section: 0,08mm<sup>2</sup> / 1,5mm<sup>2</sup>)



## 2 Connection Assignments and Functions

- **DIP Switch Position for Option Module RP 2CA and RP 2C8**  
DIP – Switch Position **CAN**

Default = alle off

2<sup>0</sup> . . . . . 2<sup>8</sup>  
Note numbers  
0 - 127

1 . . . . 4  
Bus-termination

2<sup>0</sup> . . 2<sup>2</sup>  
Baud rate  
CAN1

2 <sup>2</sup>	2 <sup>1</sup>	2 <sup>0</sup>		
0	0	0	0	20 kbaud
0	0	1	1	50 kbaud
0	1	0	2	100 kbaud
0	1	1	3	125 kbaud
1	0	0	4	250 kbaud
1	0	1	5	500 kbaud
1	1	0	6	800 kbaud
1	1	1	7	1000 kbaud (1Mbaud)

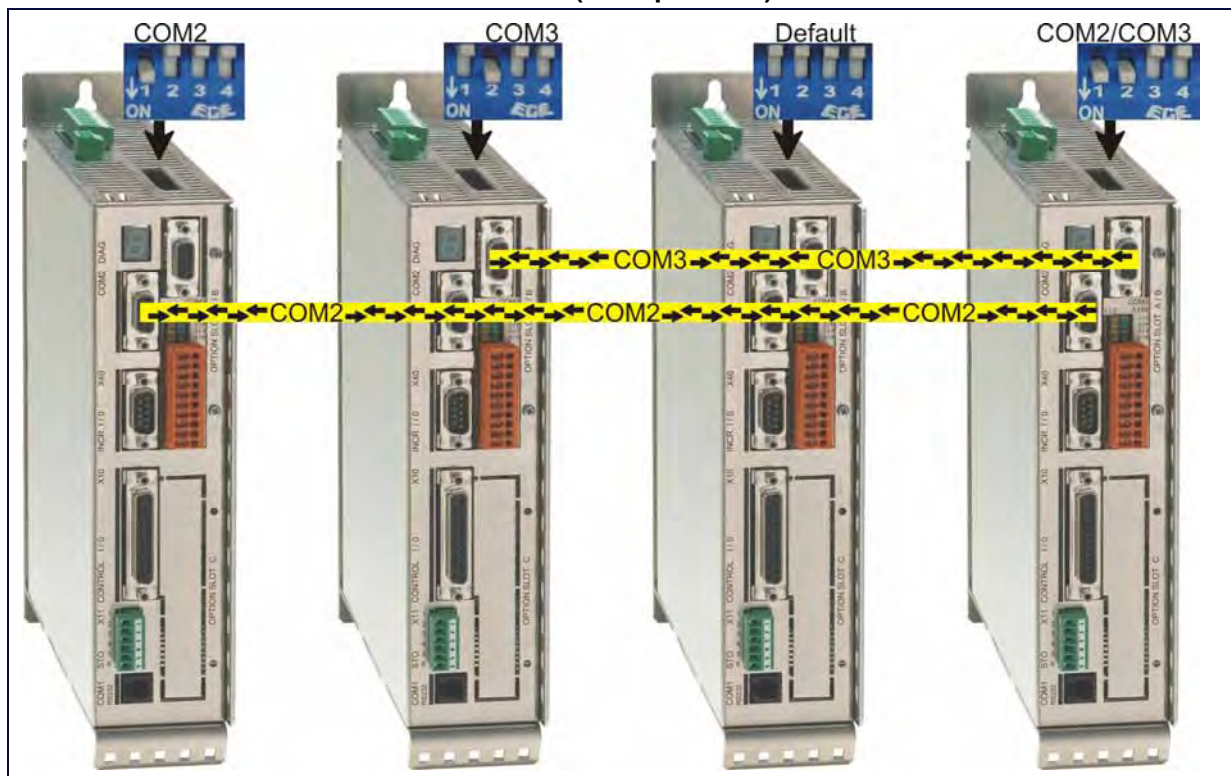

**Example:** Note number 5 / 1Mbaud

DIP – Switch Position **BUS – Termination (Example 638A)**



## 2.12 Fieldbus Interface RP CCA, CC8

- Pinning CAN1-BUS, CAN2-BUS and RS485

Module: RP CCA, CC8			CAN1	
PIN	Function	Designation		
1	-	-		
2	CAN_L Bus Line (dominant low)	CAN_L		
3	Ground	CAN-GND		
4	-	-		
5	-	-		
6	Optional Ground	CAN-GND		
7	CAN_H Bus Line (dominant high)	CAN_H		
8	-	-		
9	-	-		
CAN2		RS485	CAN2-BUS / RS485	
1	-	Data-IN inv.		
2	CAN_L Bus Line (dominant low)	-		
3	Ground	485-/CAN-GND		
4	-	DATA-IN		
5	-	GND (optional)		
6	Ground	485-/CAN-GND		
7	CAN_H Bus Line (dominant high)	-		
8	-	Data-OUT		
9	-	Data-OUT inv.		

with galvanic isolation

- Pinning RP CC8 X120 (with I/O's)

X120	Function		BIAS PIN	Status	
	0	1			
1	BIAS	Reset Drive Fault	Input 121	Input	
2	BIAS	Limit Switch +	Input 122	Input	
3	BIAS	Limit Switch -	Input 123	Input	
4	BIAS	Reference Switch	Input 124	Input	
5	BIAS	Cam 1	Output 125	Output	
6	BIAS	Cam 2	Output 126	Output	
7	BIAS	Cam 3	Output 127	Output	
8	BIAS	Cam 4	Output 128	Output	
9	Ext. +24 V Supply		-	Ub	
10	Ground Reference 0 V		-	B	

The signal status of the I/O's is shown with a 2mm LED  
 LED on I/O = high / LED off I/O = low.  
 (min./max. cable cross-section: 0,08mm<sup>2</sup> / 1,5mm<sup>2</sup>)

## 2 Connection Assignments and Functions

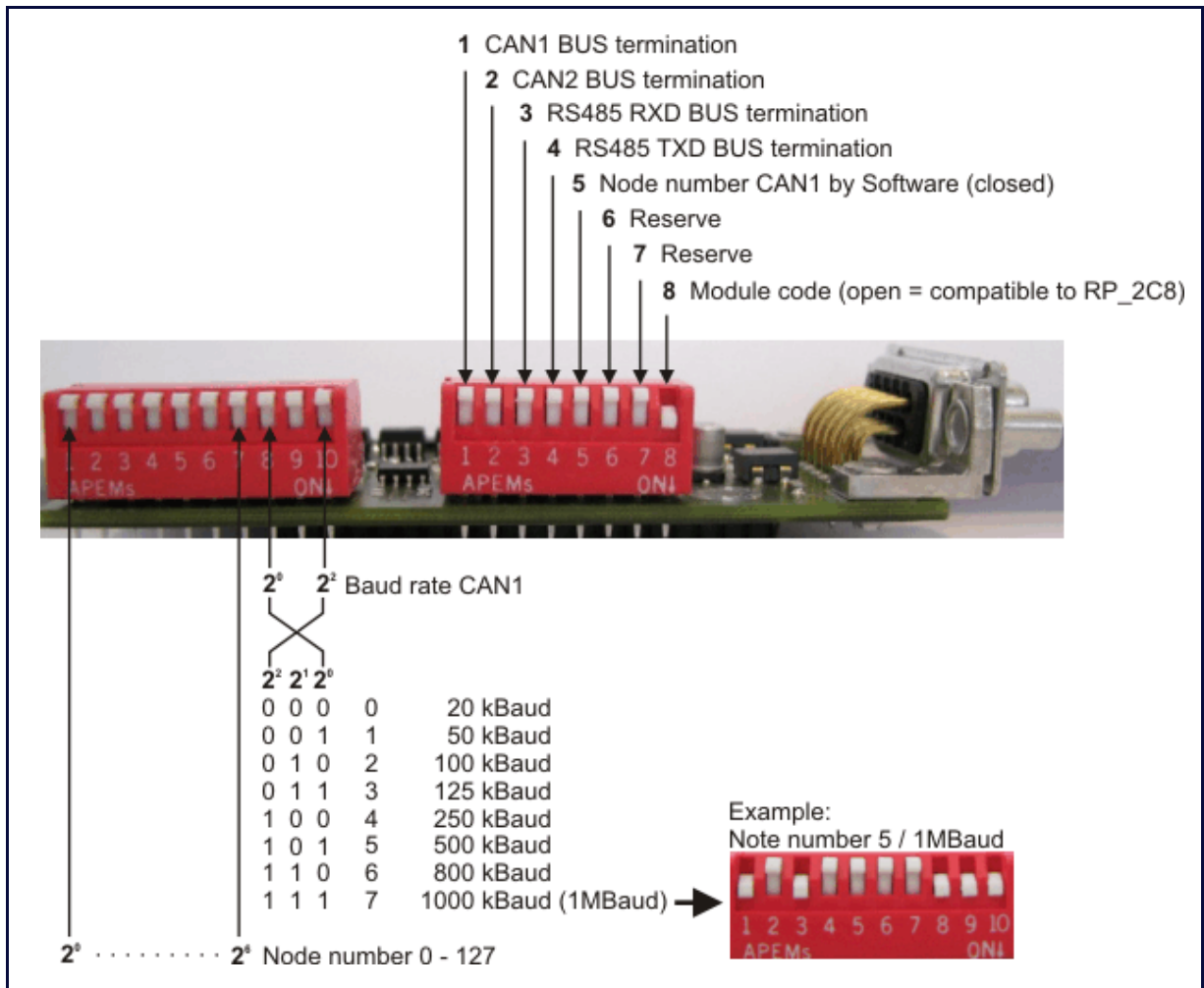

- **DIP Switch Position for Option Module RP CCA and RP CC8**  
DIP – Switch Position **CAN**





### 2.13 Fieldbus Interface RP PCA, PC8

- Pinning Profibus DP and CAN2-BUS and RS485

Module: RP PCA, PC8			Profibus DP	
PIN	Function	Designation		
1	-	-		
2	-	-		
3	Line B	B		
4	Request to Send	RTS		
5	Ground	PDP-GND		
6	Potential +5V	+5V		
7	-	-		
8	Line A	A		
9	-	-		
CAN2			CAN2-BUS / RS485	
RS485		Designation		
1	-	Data-IN inv.		
2	CAN_L Bus Line (dominant low)	-		
3	Ground	485-/CAN-GND		
4	-	DATA-IN		
5	-	GND (optional)		
6	Ground	485-/CAN-GND		
7	CAN_H Bus Line (dominant high)	-		
8	-	Data-OUT		
9	-	Data-OUT inv.		

- Pinning RP PC8 / X120 (with I/O's)

X120	Function		BIAS PIN	Status	I/O's
	0	1			
1	BIAS	Reset Drive Fault	Input 121	Input	
2	BIAS	Limit Switch +	Input 122	Input	
3	BIAS	Limit Switch -	Input 123	Input	
4	BIAS	Reference Switch	Input 124	Input	
5	BIAS	Cam 1	Output 125	Output	
6	BIAS	Cam 2	Output 126	Output	
7	BIAS	Cam 3	Output 127	Output	
8	BIAS	Cam 4	Output 128	Output	
9	Ext. +24 V Supply		-	Ub	
10	Ground Reference 0 V		-	B	

The signal status of the I/O's is shown with a 2mm LED  
 LED on I/O = high / LED off I/O = low.  
 (min./max. cable cross-section: 0,08mm<sup>2</sup> / 1,5mm<sup>2</sup>)

## 2 Connection Assignments and Functions

- **DIP Switch Position for Option Module RP PCA, PC8**  
DIP – Switch Position **CAN2 / RS485** and **Profibus DP**

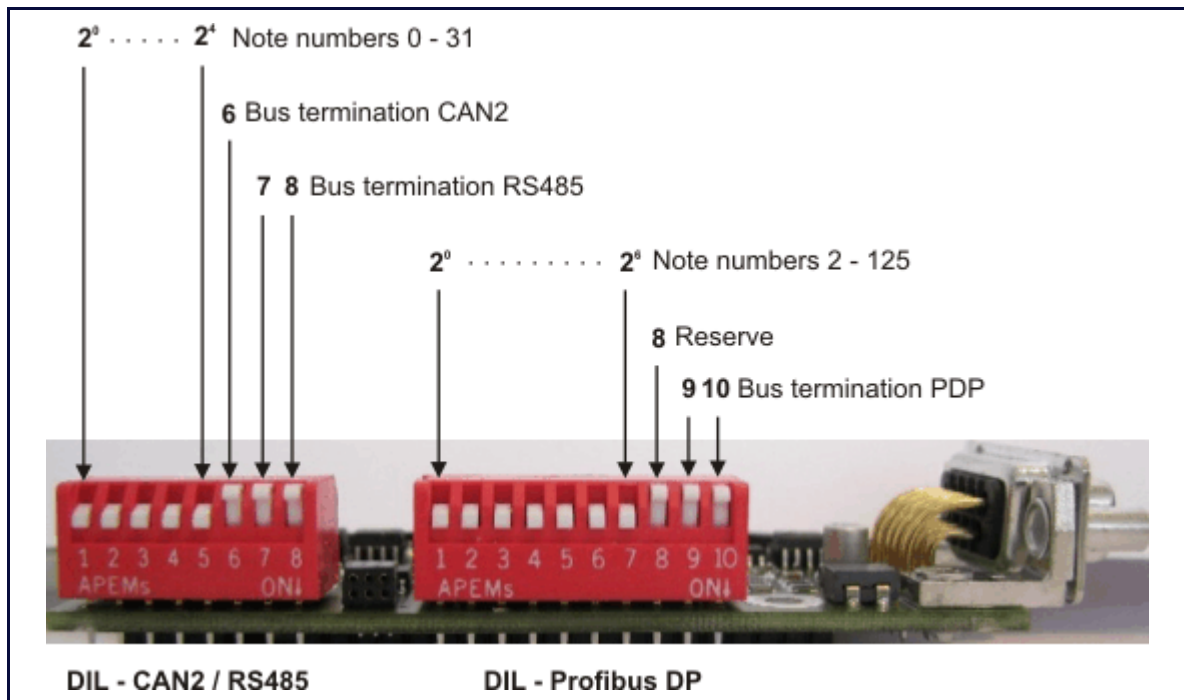

Further information for the Profibus DP: See Documentation 07-05-04-02-E-Vxxxx.

### 2.14 Overview of the Terminal Cross Section

Cross Section		638A	638B	638C
		[mm <sup>2</sup> ]	[mm <sup>2</sup> ]	[mm <sup>2</sup> ]
<b>X60</b> Line, Brakeresistor , DC-Link	Solid Core / Multiple conductor line	0,2-2,5	0,2-10 0,2-6	0,75-16 0,75-16
	Flexible with ferrule without plastic sleeve	0,25-2,5	0,25-6	0,5-16
	Flexible with ferrule with plastic sleeve	0,25-2,5	0,25-4	0,5-16
	Flexible with TWIN- ferrule with plastic sleeve	0,5-1	0,25-1,5	0,5-6
	Approbation Data UL/C-UL-US CSA	[AWG] 30-12 28-12		[AWG] 20-6
Stud Torque [Nm]		0,5-0,6	Spring tension	1,7-1,8
<b>X01</b> Control Voltage <b>X11</b> STO, Active <b>X62</b> Brake, Thermo	Solid Core and Multiple conductor line	0,14-1,5	0,14-1,5	0,14-1,5
	Flexible with ferrule without plastic sleeve	0,25-1,5	0,25-1,5	0,25-1,5
	Flexible with ferrule with plastic sleeve	0,25-0,5	0,25-0,5	0,25-0,5
	Flexible with TWIN- ferrule with plastic sleeve	0,5-1	0,25-1	0,25-1
	Approbation Data UL/C-UL-US CSA	[AWG] 30-14 30-14	[AWG] 30-14 30-14	[AWG] 30-14 30-14
Stud Torque [Nm]		0,2-0,22	0,2-0,22	0,2-0,22
<b>X61</b> Motor	Solid Core / Multiple conductor line	0,2-2,5 0,2-2,5	0,2-10 0,2-6	0,2-10 0,2-6
	Flexible with ferrule without plastic sleeve	0,25-2,5	0,25-6	0,25-6
	Flexible with ferrule with plastic sleeve	0,25-2,5	0,25-4	0,25-4
	Approbation Data UL/C-UL-US CSA	[AWG] 30-12 28-12	[AWG] 28-8 28-8	[AWG] 28-8 28-8
	Stud Torque [Nm]		0,5-0,6	0,7-0,8
<b>X120</b> Option 2C8, PC8, CC8	Solid Core and Multiple conductor line	0,08-1,5	0,08-1,5	0,08-1,5
	Approbation Data UL/C-UL-US CSA	[AWG] 28-14 28-14	[AWG] 28-14 28-14	[AWG] 28-14 28-14

# 3 Operating Mode

## 3.1 Operating Mode General

The preselection of the device functions are carried out by choosing the operating modes 0...5 according to the following table, see: ■ [Operating modes and pin functions](#), (EASYSRIDER® Windows - Software).

Each operating mode allows for the assignment of different in and output functions (F0..F6).

Operating Mode	Reference Source	Hints for Selecting the Operating Mode
0 1 2	Analog (X10.5/18)	Switching the operating modes 1 and 2 through input X10.24 Speed control analog Torque controller analog
3	Analog (X10.5/18) / Digital	Simple applications with the requirement of switching between position and speed control position controller (input X10.24). Handling like operating mode 4
4	Digital or Analog in acc. to parameter settings	General position controlled systems - Up to 10 positions can be stored under identifier-numbers and activated as shown.
pos. selection (Nr. 0...9)      function F2 data $2^0...2^4$ input start                      function F2 X10.2 axis move to selected position-number output position reached      function F0 X10.12 t1= 2ms minimum                  t2= 2ms minimum		<p>The diagram shows a timing sequence for a position-controlled system. It features several digital signals: 'pos. selection' (a pulse), 'input start' (a pulse), and 'output position reached' (a pulse). A shaded rectangular area represents the 'axis move to selected position-number'. Time intervals t1 and t2 are indicated at the bottom, corresponding to the duration of the start and reached signals respectively.</p>
5	Digital or Analog in acc. to programming or via digital communication (e.g. fieldbus)	Simple to complex systems using BIAS instructions - (up to 1500 command blocks) PLC Functions

## 3.2 Operating Modes and Pin Functions

Available Contact Numbers	Operating Modes					
	0 Torque / Speed- Control	1 Speed Control	2 Torque Control	3 Position / Speed Control	4 Position Control	5 Position Control + BIAS Functions
Input X10.14	F0, F1	F0, F1	F0, F1	F0, F1, F2, F3	F0, F1, F2, F3, F6	F0, F1, F2, F6
Input X10.15	F0, F1	F0, F1	F0, F1	F0, F1, F2, F3	F0, F1, F2, F3, F6	F0, F1, F2, F6
Input X10.4	---	---	---	---	F2, F6	F0, F2, F3, F6
Input X10.25	---	---	---	---	F2, F6	F0, F2, F3, F6
Input X10.11	F1	F1	F1	F1	F1, F2, F6	F0, F1, F2, F3, F6
Input X10.24	F0 L = torque- H = speed control	---	---	F0 L = torque- H = speed control	F1, F2, F6	F1, F2, F3, F6
Input X10.2	---	---	---	---	F0	F2, F3
Output X10.12	F0, F2, F5	F0, F2, F5	F0, F2, F5	F0, F1, F3, F5	F0, F1, F3, F5	F0, F1, F2, F3, F4, F5
Output X10.13	F0, F2, F5	F0, F2, F5	F0, F2, F5	F0, F1, F3, F5	F0, F1, F3, F5	F0, F1, F2, F3, F4, F5
Output X10.20	F0, F2, F5	F0, F2, F5	F0, F2, F5	F0, F1, F3, F5	F0, F1, F3, F5	F0, F1, F2, F3, F4, F5
Output X62.3 X62.4	F0, F2, F5	F0, F2, F5	F0, F2, F5	F0, F1, F3, F5	F0, F1, F3, F5	F0, F1, F2, F3, F4, F5

## 3 Operating Mode

### 3.3 Configurable Pin Functions (Operating Mode Dependent)

Input Nr.	Input Functions (Operating Mode Dependent)							Function F6 <sup>2)</sup>
	Function F0	Function F1	Function F2	Function F3	Function F4	Function F5		
Input X10.14	☒	3) limit switch +	1) set selection data 2 <sup>0</sup>	move manually +	☒	☒	CAN Node no. 2 <sup>0</sup>	
Input X10.15	☒	3) limit switch -	1) set selection data 2 <sup>a</sup>	move manually -	☒	☒	CAN Node no. 2 <sup>a</sup>	
Input X10.4	latch input 1 ⏏	extended latch	1) set selection data 2 <sup>b</sup>	☒	☒	☒	CAN Node no. 2 <sup>b</sup>	
Input X10.25	latch input 2 ⏏	☒	1) set selection data 2 <sup>c</sup>	☒	☒	☒	CAN Node no. 2 <sup>c</sup>	
Input X10.11	start (slope 0->1) for BIAS - move commands	3) regulator trouble reset	1) set selection data 2 <sup>d</sup>	☒	☒	☒	CAN Node no. 2 <sup>d</sup>	
Input X10.24	operating mode selection (0) – 1 or 2 (3) – 1 or 4	3) reference sensor	1) set selection data 2 <sup>max</sup>	☒	☒	☒	CAN Node no. 2 <sup>max</sup>	
Input X10.2	start (slope 0->1) with position set selection in position control (4)	☒	strobe (slope 0->1) for BIAS-set selection	☒	☒	☒	☒	

Output X10.12	position reached	reference output	☒	tracking window exceeded	synchron-format trigger	no drive trouble	-
Output X10.13	temperature monitoring	reference output	☒	tracking window exceeded	start offset trigger	no regulator trouble	-
Output X10.20	warning	reference output	☒	tracking window exceeded	☒	no drive trouble	-
Output X62.3 X62.4	active ok (motor brake)	reference output	☒	tracking window exceeded	☒	no drive trouble	-

☒ BIAS function is freely programmable in operating mode 5. - No function in operating modes 0 to 4.

⏏ Fast input for optimal timing.

- 1) With every row (from the top to the bottom) in which the function F2 is assigned to an input, the binary value (2<sup>n</sup>) increases by 1. (See example)  
Operating mode 4: Only numbers 0 - 9 are allowed to be set!
- 2) Only possible with module RP-CAN.
- 3) If the Option RP 2C8 / PC8 (See: [Fieldbus - interface - COM2-COM3](#)) is inserted, the contact functions as described for the X10-plug are not valid. The inputs are freely programmable utilizing the BIAS program.

3.4 Functions Diagrams with Protection Mode “Switch Off”

In accordance with EASYRIDER® Windows – Software “Commissioning / Motor / Motor/30”

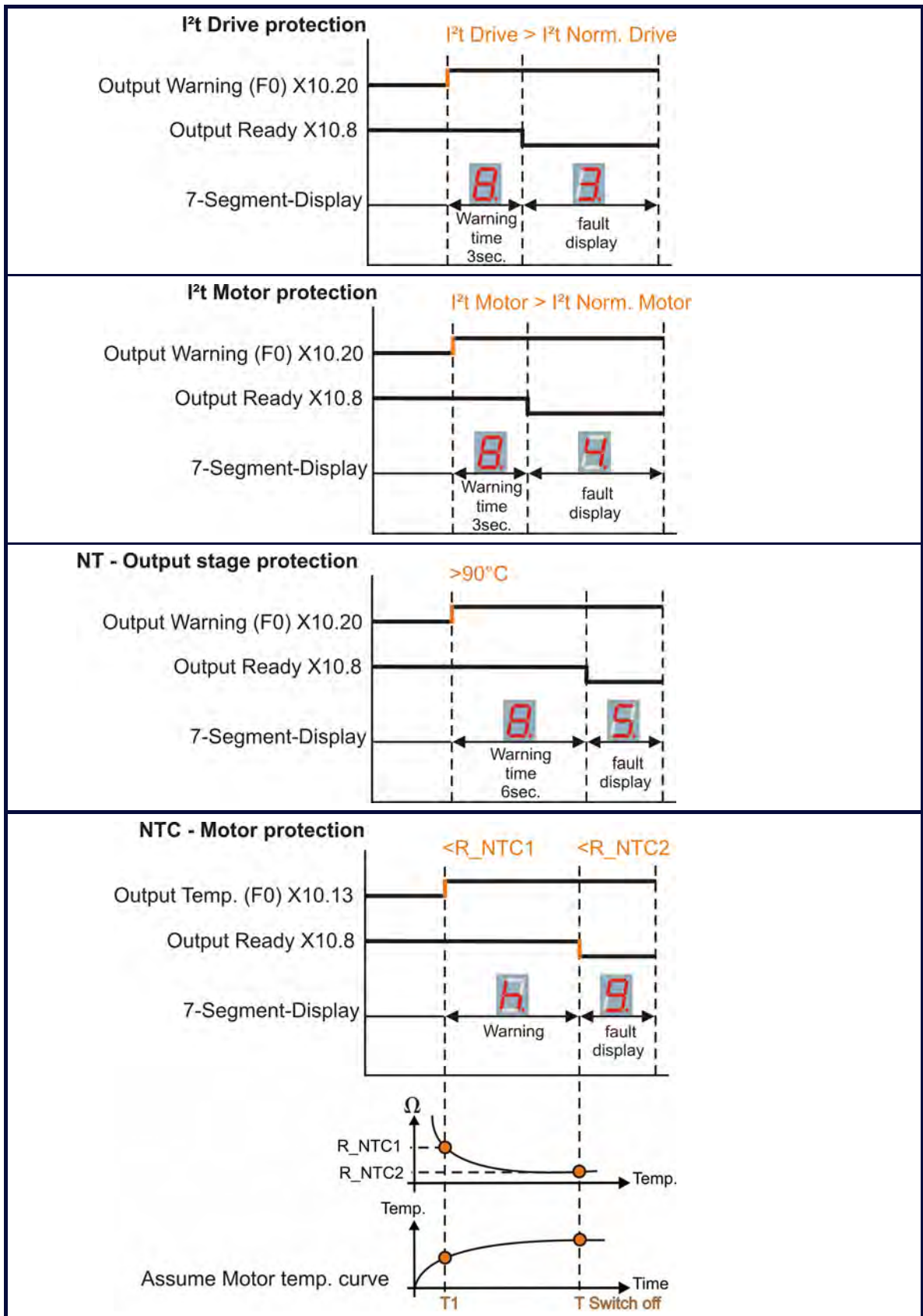



### 3 Operating Mode

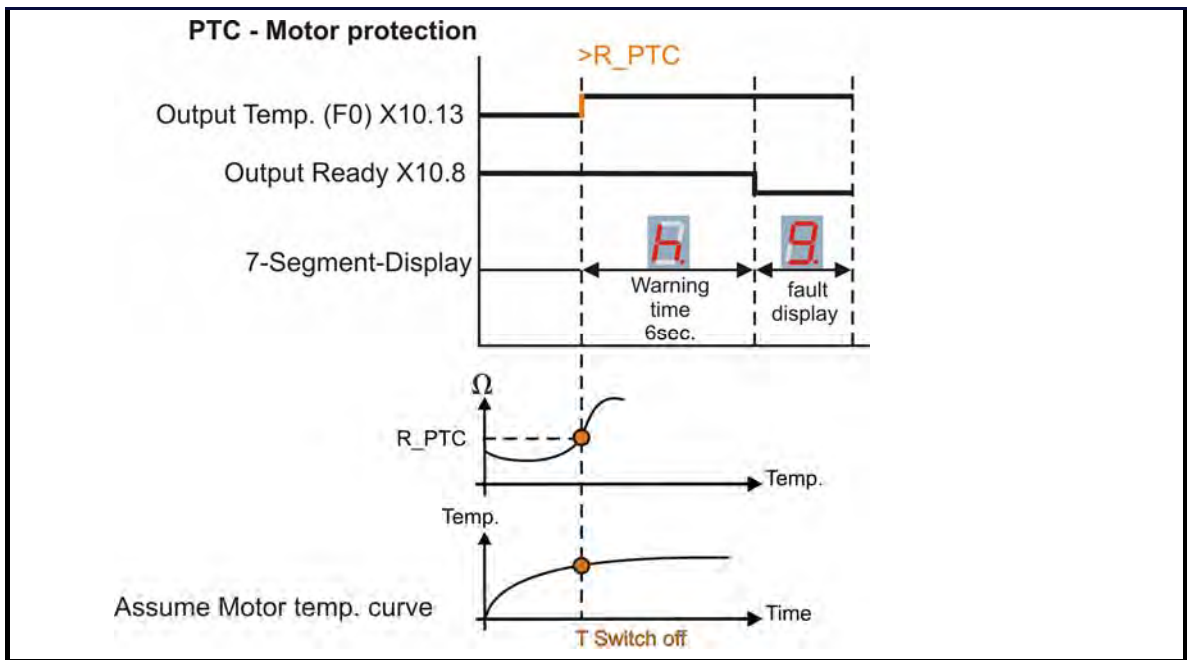

### 4.1 Mounting

In order to guarantee the best possible air circulation for the cooling unit, the servo drive should only be installed in a vertical position. The vertical installation above other systems or heat producing units can cause overheating.

### 4.2 Control Cabinet Mounting

Installation should be carried out only in a control cabinet in which the inside is free from dust, corrosive fumes, gases and liquids.

Make absolutely sure that the condensing of evaporating liquids including atmospheric moisture is avoided. Should the digital servo drive be installed in a place where condensation is likely, a suitable anti-condensation heater must be installed. The heater must be SWITCHED OFF during normal operation.

Automatic switch off is recommended

The servo drives should not be installed in areas which have been classified as dangerous, unless they have been installed in an approved enclosure and in accordance with applicable regulations. In such an application double check all aspects of the installation.

Please pay attention during installation of the unit to provide for adequate space and ventilation! (See: "■ Dimensions")

#### **General Rule:**

It is better to place heat-producing devices low in an enclosure to support internal convection and to spread out the heat. If placing such devices up high is unavoidable, enlarging the upper dimensions at the expense of height or the installation of fans should be considered.

### 4.3 Cooling and Ventilation

The digital servo drives are inherently designed to protect against damage which may be caused due to overheating. A temperature sensor is mounted on the heat sink. When the temperature reaches a level above >95°C, the unit will be automatically shut-down. This setting can not be altered.

The cooling of the power module will be assisted as much as possible with an internal fan. Depending upon the temperature the fan unit will operate at one of two levels, in order to limit unnecessary wear and potential pollution.

Make sure a cabinet of proper size is selected for adequate air circulation.

**If the device is placed and operated in a non-ventilated environment, the case volume of the specified control cabinet must be calculated in accordance with the following table!**

Unit	Volume / Cabinet
638A01..- 638A06..	0,12 m <sup>3</sup>
638B03..- 638B05	0,15 m <sup>3</sup>
638B08..- 638B15	0,25 m <sup>3</sup>
638C	0,35 m <sup>3</sup>

**For more specific information, please refer to the information provided by the manufacturer of the cabinet.**

# 5 Electrical Installation

## 5.1 Installation General

- **Safety**

The voltages carried by power supply cables, motor cables, connectors, and certain parts of the drive can cause serious electric shock and even death

- **Danger of Electric Shock**



**Caution !**

Risk of electrical shock, wait 3 minutes after switching off, for discharging of the capacitors.

Disconnect the drive unit from the mains before working on it. A period of **three minutes must** pass after switching off so that the internal capacitors can discharge completely. Until the discharge

time is over, there can be dangerous voltage stored in the module !

Persons, who monitor or carry out electrical installation and maintenance must be adequately qualified and schooled in these activities.

- **Dangerous Areas**

The use of variable speed drives of all kinds can invalidate the certification for dangerous areas (apparatus group and/or temperature class) of explosion-protected motors. Inspection and certification for the complete installation of servo motors and electronic components **must** be obtained.

- **Grounding - Safety Grounding**

The grounding impedance must meet the requirements of local industrial safety regulations and should be inspected and checked at appropriate and regular intervals

- **Ground Connections**

It is recommended to attach a ground bus, made of high conductivity copper, as near as possible to

the servo-rack or regulator modules in order to minimize the length of the cable run connections.

The recommended dimensions are:

**Thickness:  $d = 5$  to  $6$  mm**

Length (m)	Width (mm)	
< 0,5	20	
0,5 < 1,0	40	
1,0 < 1,5	50	

Due to increased discharge currents > DC 10mA resp. > AC 3,5mA the grounding connection of the drive has to be connected 2 times. At power supply connector X60.7 and at the housing grounding screw!

- **Short-Circuit Capacity and Discharge Currents**

Due to the working principles of servo drives, there may discharge currents to the ground exceeding DC 10mA resp. AC 3,5mA.

Suitable for use in a system capable of delivering not more than 5000 RMS symmetrical amperes 240V (638A) or 480V (638B/C) maximum. (Note according to UL508C)

## 5.2 Power Mains Connection

- **Types of power mains**

The 638 servo drives can be directly connected to TT- and TN-Systems (TT- and TN-Systems are three-phase systems with grounded neutral).

When using the servo drive in IT mains (three-phase systems without grounded neutral), isolation transformers must be used.

The secondary neutral must be grounded and connected to the 638 protective ground conductor.

General is valid, that with a phase-earth voltage (rated isolation voltage) > 300V AC the isolation requirements (necessary clearance- and creepage distance, Test voltage, etc.)

Concerning the EC Low Voltage Guideline is not filled anymore and so that the CE conformity is not given.

- **Mains supply voltage range 638A**

The nominal supply voltage range is 1/3\*230V AC +/-10%.

Respective intermediate transformers must be used for higher supply voltages.

With grounded power mains, autotransformers can also be used to adjust the voltage.

Neutral does not have to be connected for this type of transformer.

It is possible to use a lower supply voltage range. Note: In this case the internal DC-BUS capacity may be not high enough (specially in 1 phase mains supply) and the user has to adjust the undervoltage monitoring parameter of the drive.

- **Mains supply voltage range 638B/C**

The nominal supply voltage range is 3\*400 / 480 AC +/-10%.

It is possible to use a lower supply voltage range. Note: In this case the internal DC-BUS capacity may be not high enough and the user has to adjust the undervoltage monitoring parameter of the drive.

- **Protective Ground Connection (PE)**

The following information concerning the protective ground connection corresponds to EN 61800-5-1 Item 4.2.5.4.1 and 4.2.5.4.2.

- **Cable cross section**

The cross section for the protective ground conductor at X60 corresponds to the external conductor.

The 638 servo drive is a devices with increased leakage current (larger than 3,5 mA AC or 10mA DC). Therefore a second protective ground conductor must be connected at the case-groundbolt. (with the same cross-section as the first protective ground conductor on X60).

- **Dimensioning of power mains cable and the over-current protection**

The cross-section from the power main cable and the rated current for the over-current protection should be dimensioned for the average current load to be expected.

In the supply line a protection about a protective circuit breaker or fuse shall be provided.

Circuit breakers with tripping-characteristic C or fuses with tripping-characteristic gM are to be used.

One determines the load to be expected on the average as follows:

$$\text{1-phase supply: } I_{mains}[A] = \frac{S[VA]}{U_{Netz}[V]} \quad \text{3-phase supply: } I_{mains}[A] = \frac{S[VA]}{\sqrt{3} \times U_{Netz}[V]}$$

The apparent power S can be calculated to that as follows:

$$S[VA] = M_{eff}[Nm] \times k \times \frac{2 \times \pi \times n_{average}[\text{min}^{-1}]}{60}$$

The constant k for the different servo drives can be taken from the following table:

## 5 Electrical Installation

Type	638A-1A	638A-2A	638A-4A	638A-6A
constant k	1,4	1,22	1,22	1,2

Type	638B-03	638B-05	638B-08	638B-10	638B-15
constant k	1,29	1,13	1,13	1,11	1,08

When information about load torque, Inertia and the friction-situation be there, the effective momentum is calculated with following formula:  
(in case of correct motor dimensioning also the rated torque of the employed motor can be used):

$$M_{eff} [Nm] = \sqrt{\frac{1}{T_{cycle} [s]} \times \sum_i M_i [Nm]^2 \times t_i [s]}$$

For the determination of  $n_{average}$  there must be corresponding information about the positioning-cycle.

$$n_{average} [\text{min}^{-1}] = \frac{1}{T_{cycle} [s]} \times \sum_i n_i [\text{min}^{-1}] \times t_i [s]$$

The cross section of the power main cable and the rated current of the used fuse are chosen in accordance with table "Current-carrying capacity of PVC isolated three-phase cable or single conductors" so, that the permissible current-carrying capacity of the chosen cross section larger or alike to the calculated main current. With drive groups this is the sum of the main currents.

$$I_{\text{current-carrying capacity}} \geq I_{\text{main}} \quad I_{\text{current-carrying capacity}} \geq \sum I_{\text{main}}$$

The rated current of the fuse must be equal to or less than the permissible current-carrying capacity of the chosen cross sectional cable.

$$I_R \leq I_{\text{current-carrying capacity}} \quad I_R \leq \sum I_{\text{current-carrying capacity}}$$

The following table show the maximum current load of PVC insulated three-phase cables (or conducting wires) according to IEC60204-1 at 40°C environmental temperature and 70°C maximum conductor temperature.

Line cross section	Individual wires in insulating conduit or cable duct B1	Cable in insulating conduit or cable duct B2	Cable on walls C	Cable in a cable tray E
[mm <sup>2</sup> ]	[A <sub>eff</sub> ]	[A <sub>eff</sub> ]	[A <sub>eff</sub> ]	[A <sub>eff</sub> ]
0,75	7,6			
1,0	10,4	9,6	11,7	11,5
1,5	13,5	12,2	15,2	16,1
2,5	18,3	16,5	21	22
4,0	25	23	28	30
6,0	32	40	36	37
10	44	40	50	52
16	60	53	66	70

When determinating the cross section for he power mains, make sure that the cross section selected is within the range that can be used with power mains terminal X60. See Assignments Power Connections.

### – Dimensioning the Line Contactor

The rated current of the line conductor is oriented to the over-current for the power mains connection.

The line contactor is set up so that nominal operating current specified by the manufacturer of the line contactor for category AC-1 is approximately 1.3 times the rated current of the over current protection.

- Fault Current Protection  
 Servo Drive of the 638series can cause a DC current in protective grounding.  
 Where for the protection in case of a direct or indirect contact residual current device (RCD) is used, only a RCD of the type B (AC-DC sensitive) is permissible on the current supply side. If is permissible for application should types with increased trip current (300mA) and/or. short time-delayed to be used.  
 A another preventive measure must be used, e.g. separation from the environment by double or reinforced insulation or separation from the public supply system by a transformer.

– **Rated Fault Current**

Line filters have high discharge currents due to intern capacities.  
 In the servo drive of the series 638 an intern line filter is integrated.  
 Additional discharge currents are caused by the capacities of the Motor cable and the motor winding.  
 Through the PWM frequency of the Inverter the leakage current have high frequently rates.  
 The suitability of the RCD is to test for the respective application.  
 Generally we do not recommend the operation with RCD's.  
 The value of the leakage current depends on the following points:

- Lenght and characteristic of the motorcable
- PWM-Frequency
- Operation with or without shielding
- How and where is the motor housing grounded

**Comment:**

High fault currents can occur:

- Extreme unbalance factor of the three phase system.
- When connecting to the power mains (short-term single- or two-phase operation because of contact chatter on the line contactor)

**Estimation:**

Single-phase or two-phase operation (as intermediate state when switching on the line contactor):

$$I_A[A] = \frac{U_{Netz}[V] \times 2 \times \pi \times f_{Netz}[Hz] \times C_A[F]}{\sqrt{3}}$$

Single-phase operation with neutral line:

$$I_A[A] = \frac{U_{Netz}[V] \times 2 \times \pi \times f_{Netz}[Hz] \times C_A[F]}{2 \times \sqrt{3}}$$

The discharge capacitance C<sub>A</sub> the various 638 Servo Drives can be taken from the following table:

	638A-01..06 1phase	Servo Drives 638A-01..06 3phase	638A-01..06A 1/3phase (JP 600 open)	Filter LNF RA-230/12 1phasig
Discharge capacitance	230nF	277nF	136nF	10nF
	-	Servo Drives 638B03..15 3phasig	638B03..15 x A 3phasig	
Discharge capacitance	-	1610nF	200nF	

**Recommendation:**

For less leakage current operation with 1phase supply it can be recommended the following combination. Use a Servo Drive with the optional Version 638Axx-3-A<sup>1)</sup> and a low leakage line-filter Typ LNF RA \*230/12.

<sup>1)</sup> AC-sided Y-Capacitance deactive (JP600 open, see chapter Jumper)

When several 638A servo drives operates with 1phase supply and 3 phase are available in the machine, the drives should be divided similar on the 3 phases so that the charging currents obliterate mutually when the system is powered up.

	<p><b>Note:</b>          It only allowed, to connect the DC-Link Voltage between drives which are connected to the same phase or which have 3 phase supply.</p>
---	---

## 5 Electrical Installation

### 5.3 DC Link Parallel Connection

- **General**

With the operation of a group of drives it is possible to couple the DC link circuit of the 638 Drives.

**Advantages:**

- Positive energy balancing - utilization of braking energy, with energy equalization achieved through the DC link
- Smaller load on the ballast resistors
- Increased DC link capacity through smaller residual rippling, specifically with single phase applications
- Increase of the internal ballast peak performance
- Increase of the internal ballast continuous power rating
- Internal unit balancing resistance provides for a uniform rectifier load sharing with a parallel incoming power supply

- **Variation 1; Servo Drives without DC LINK protection**

**Block Diagram 1**

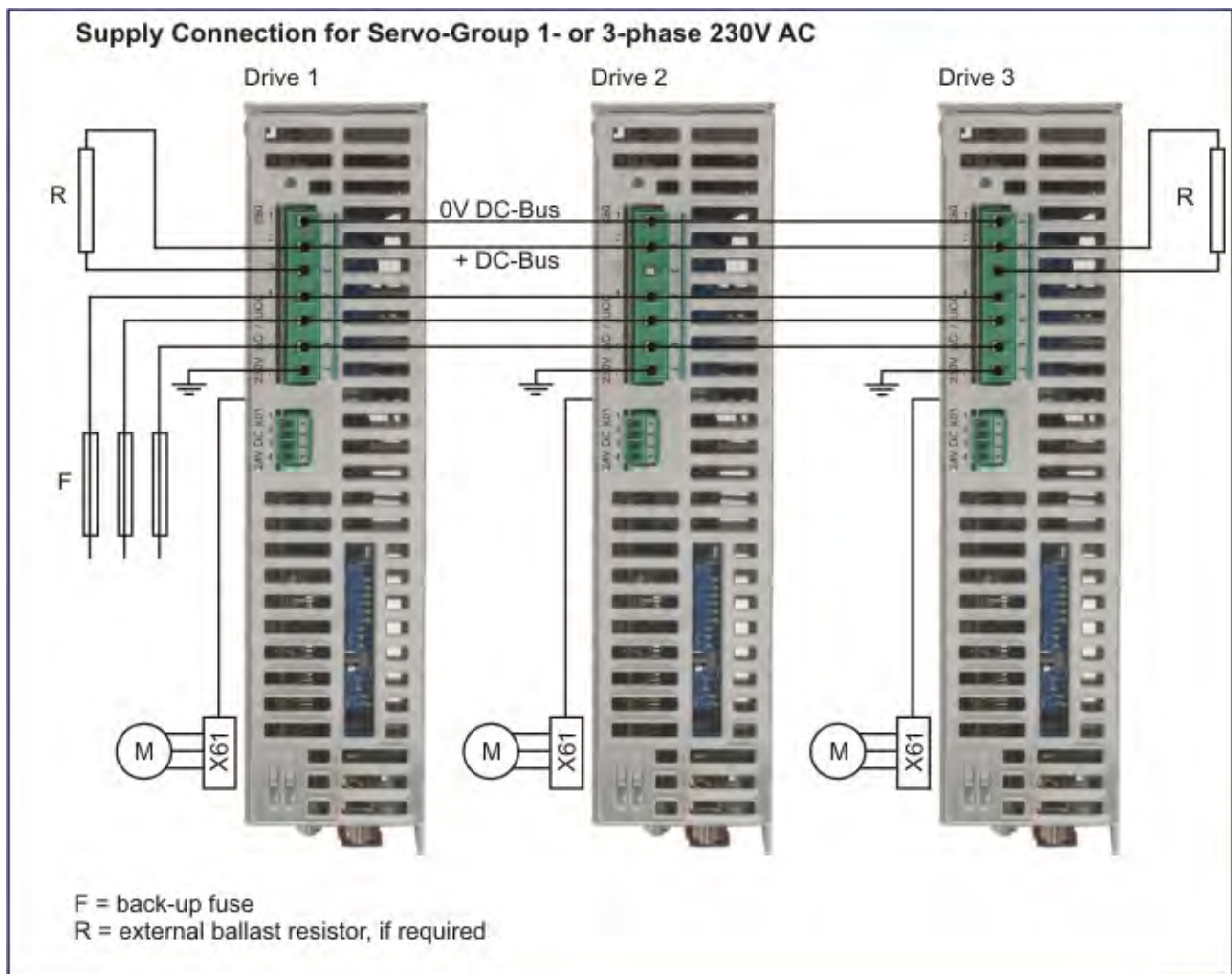

**Advantage:**

- no DC-fuses necessary.

**Disadvantage:**

- Sum of power limited by line fuse.



- Variation 2; Servo Drives with DC LINK protection

**Block Diagram 2**

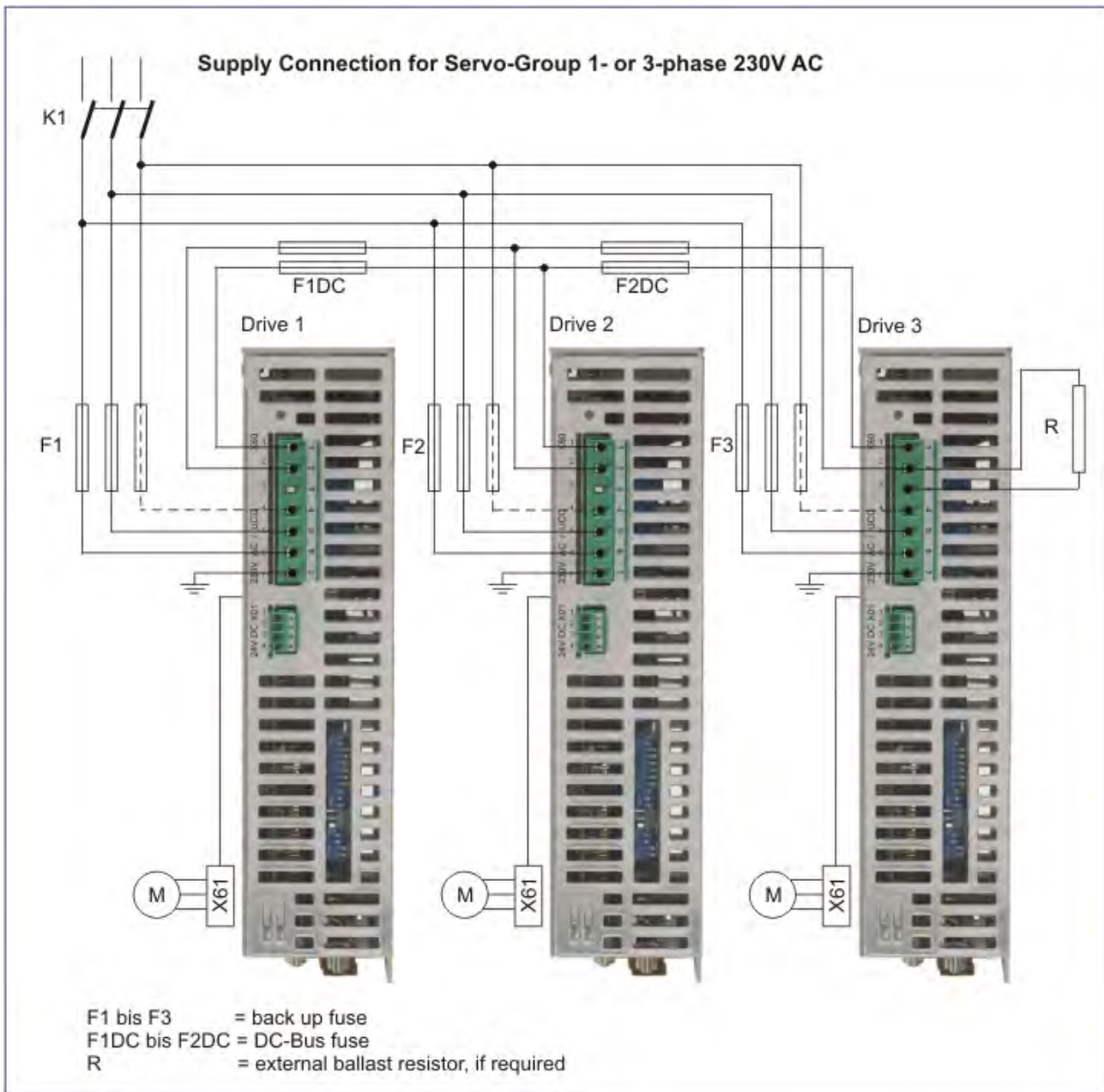

**Advantage:**

- Sum of power not limited by line fuse.

**Disadvantage:**

- DC-fuses necessary.

## 5 Electrical Installation

- **Function Softstart**

When switch on the supply voltage the DC link capacities become over a resistance loaded. Attain the undervoltage threshold + constant waiting period (2,4s) that becomes charging resistor by

a relay bridges. The operating status „undervoltage “changes at the same time in „ready“.

When switching the supply voltage off the soft starting function becomes only after falling below undervoltage threshold again actively. It is therefore particularly with intermediate circuit-coupled Drives importantly before restarting the supply voltage to wait to those under voltage threshold is reached.





Up to standard undervoltage threshold of 160V the unchargeing time for the 6A-Drives is approx. 30 seconds.

**Uncharging time to undervoltage threshold (160V) see table:**

Typ	638A01..06	638B03..05	638B08..15	638C
time	max. 30sec.	max. 28sec.	max.42sec.	being prepared

- **Installation Instructions and Warnings**

- The DC-Link connections of the Series 638 are not short circuit - and earth fault proof and not protected against polarity reversal. A short circuit on the DC-Bus wires can be damage the rectifier in the Device.  
In order to protect the rectifier also in the circuit variant 1, mains fuses of the class gRL must be set in. These are fuses with combined protection for wires and semiconductors.
- With a common DC link bus, one should employ the 638A Series of Servo Drives exclusively.
- Drives which are located immediately next to each other, within the same control cabinet, should be carefully arranged with the DC links being made employing a short wire connection.

	<b>Note:</b> Connect maximum 4 Servo drives together.
	<b>Note:</b> Units should be turned on together as shown. (Contactor K1) Switching delays can endanger the function of the rectifier and the “soft-power-up-circuitry”, (wear effect).
	<b>Note:</b> The failure of individual AC fuses can go unnoticed as the power continues to be delivered through the DC-bus of the units connected in parallel. Regular checks of the fuses are therefore strongly recommended.
	<b>Note:</b> Careful planning and wiring are imperative! A short-circuit on DC bus link connections can cause serious damage to the rectifiers and drives.
	<b>Note:</b> With single phase power-supply at 638A Devices it is recommended that only the same phase is used for all coupled drives. The connection of different phases generates a DC-Link voltage of 565V DC! This can damage the devices.

- **Layout of the Ballast Capacity**

Energy, which is produced by the electrical brake motor, will be fed into the DC link and then through the DC link coupling to serve other motors within the sequence. Only a portion of the energy which is produced in this manner leads to an increase in the DC link voltage and will then, at a specified voltage threshold, be converted to heat and released through the units' internal or external ballast. Therefore, an energy exchange occurs between the units, creating a positive energy balancing and overall work load balance of the ballast switches. A significant reduction factor in the load can be anticipated, depending upon the specifics of the installation.

Layout Step by Step (without reduction factors)	Remarks
<ul style="list-style-type: none"> <li>➤ Addition of all internal unit ballast continuous ratings</li> <li>➤ Addition of all internal unit ballast peak performance ratings</li> <li>➤ For information concerning the required data and design layout of the ballast resistance: See Chapter -  <a href="#">“● Layout of the Ballast Resistance“</a></li> <li>➤ Arrange the external ballast resistance with regard for the braking power occurrence, if possible.</li> </ul>	<p>The load on the internal ballast will be evenly divided between all of the units connected in parallel.</p>

v

## 5 Electrical Installation

### 5.4 Fuses , Contactors

- 638A

Servo - Driver			638A01..	638A02..	638A04..	638A06..
<b>Fuse, Contactor</b>						
FI – Switch			Not recommended			
Input Supply Current 1 phase	1)	[A]	2, 8	4,7	9,4	11
Input Supply Current 3 phase	1)	[A]	1,6	2,7	5,4	7,8
Fusible cut-out VDE		Type	6..16A gG	6..16A gG	10..16A gG	16A gG
Automatic circuit breaker VDE		Type	B6A..16A	B6A..16A	B10A..16A	B16A
Fusible cut-out UL	2)	Type	6A..15A	6A..15A	10..15A	15A
Line contactor	3)	Type	DILM7	DILM7	DILM7	DILM7
Fusible cut-out DC-link resp. AC-supply variant 1	4)	Type	10A..16A gRL	10A..16A gRL	10A..16A gRL	10A..16A gRL

- 638B

Servo - Driver			638B03..	638B05..	638B08..	638B10..	638B15..
<b>Fuse, Contactor</b>							
FI – Switch			Not recommended.				
Input Supply Current 3 phase	1)	[A]	3,2	5,6	8,5	8,9	11,4
Fusible cut-out VDE		Type	6..16A gG	6..16A gG	10..16A gG	16A gG	16A gG
Automatic circuit breaker VDE		Type	B6A..16A	B6A..16A	B10A..16A	B16A	B16A
Fusible cut-out UL	2)	Type	6A..15A	6A..15A	10..15A	15A	15A
Line contactor	3)	Type	DILM7	DILM7	DILM12	DILM15	DILM15
Fusible cut-out DC-link resp. AC-supply variant 1	4)	Type	10A..30A gRL	10A..30A gRL	10A..30A gRL	16..30A gRL	16A..30A gRL

- 638C

Servo Drive			638Cxx	638Cxx		
<b>Fuse, Contactor e</b>						
FI – Switch			Not recommended			
Input Supply Current 3 phase	1)	[A]	xx	xx		
Fusible cut-out VDE		Type	32A gG	40A gG		
Automatic circuit breaker VDE		Type	B32A	B40A		
Fusible cut-out UL	2)	Type	35A	40A		
Line contactor	3)	Type	DILM32	DILM40		
Fusible cut-out DC-link resp. AC-supply variant 1	4)	Type	32A gRL	40A gRL		

- 1) At maximum output voltage and rated current.
- 2) UL listed (JDDZ) Fusible cut-out Class K5 or H, or rather UL listed (JDRX) Class H.
- 3) Recommended e.g. Klöckner Moeller
- 4) Class gRL are fuses with combi-protect for Cable and Semiconductor.  
e.g. Fa. SIBA Sicherungs-Bau GmbH  
Serie 60 034.34.16; Fuseholder 5106304.x (up to 30A)  
Serie 50124.34.xx, Fuseholder 5105804.3 (up to 40A)

If these fuses are used, the mains voltage may only be switched on, when the Softstart - function is active. (Device in Undervoltage operating state).

5.5 Brake Resistor

• Selection of the Brake Resistor

When employing a braking mechanism with an operating motor driven system, the contained energy flows back into the drive. The capacitors within the motor can absorb a small portion of the excess energy. The rest of the energy must be dissipated through a resistor in heat. The activation of the Brake Resistor occurs, depending upon the voltage threshold. The resistance load is electronically simulated and monitored by our software (EASYRIDER® Windows - Software). Peak power (Pmax) and continuous power output (Pd) must be configured so that the specific requirements of the application are fulfilled.

The general rule for resistance measurements is as follows:  $P_{max} / P_d \leq 59$ .

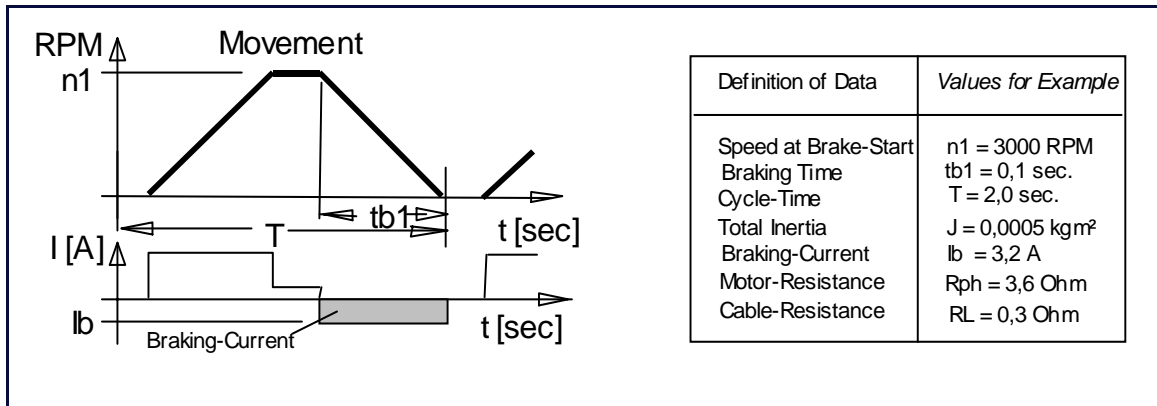

Selection	
<b>Step 1</b>	Example
<b>Evaluation of the Brake Capacity</b> (Approximation without capacitor load, friction and drive power loss)	
<b>Power of Motion:</b> $P_{kin} = 0,0055 * J * n1^2 / tb1$ [W]	$P_{kin} = 0,0055 * 0,0005 * 3000^2 / 0,1$ $P_{kin} = 247$ W
<b>Motor Power Loss:</b> $P_{vmot} = Ib^2 * (Rph + RL)$ [W]	$P_{vmot} = 3,2^2 * (3,6 + 0,3)$ $P_{vmot} = 40$ W
<b>Continuous Power:</b> $Pd = 0,9 * (P_{kin} - P_{vmot}) * tb1 / T$ [W]	$Pd = 0,9 * (247 - 40) * 0,1 / 2$ $Pd = 9,3$ W
<b>Peak Power:</b> $P_{max} = (1,8 * P_{kin}) - P_{vmot}$ [W]	$P_{max} = (1,8 * 247) - 40$ $P_{max} = 405$ W
<b>Measurements Used:</b>	
J	Total Inertia [kgm²]
n1	RPM at Start of Braking [RPM]
tb1	Braking Time [Sec]
T	Cycle Time [Sec]
Ib	Motor Braking Current [A]
Rph	Motor Resistance (terminal/ terminal) [Ω]
RL	Cable Resistance of the Power Cable [Ω]

## 5 Electrical Installation

<b>Step 2</b> <b>Is internal and/or external Brake Resistor required ?</b>	<b>Example-Drive Type:</b> <b>638</b>
<p>Is the internal Brake Resistor sufficient or is no internal resistance available? Should no resistance be available then appropriately sized external Brake Resistor can be employed to meet system requirements according to the table (See below),</p> <p>External and internal resistance can be employed in a parallel configuration. In this case the internal and external capacities can be added together.</p>	<p>Overall Rating:            Internal Resistance:            Continuous Power Pd = 20W            Peak Power Pmax = 0,83kW            Requirement:            Pd = 9,3W Pmax = 405W  <b>Result: The internal configuration is sufficient</b></p>
<b>Selection Brake Resistor</b> <b>Only Parker or by our released ballast resistors used !</b>	
<b>Servo Drives</b>	<b>Possible Brake Resistor</b>
638A01.. / 638A02.. / 638A04.. / 638A06..	33R 100W
638B033.. / 638B053..	100R 100W, 56R 200W
638B036.. / 638B056..	100R 100W
638B037.. / 638B057..	100R 100W
638B083..	100R 100W, 56R 200W, 36R 300W, 33R 300W
638B086..	100R 100W,
638B087..	100R 100W
638B106.. / 638B156..	100R 100W, 56R 200W, 36R 300W, 33R 300W
638B107.. / 638B157..	100R 100W, 56R 200W, 36R 300W, 33R 300W
638C..	being prepared

- **Configuration of the Brake Resistor**

### Brake Resistor Circuit Configurations

**1. Activate Electronic Resistance:**

The electronic resistance will be activated. "Activate Brake Resistor = Y" (Default - setting)

**2. Switching Threshold:**

The switching threshold is to be selected.

"Ucc Brake Resistor On = 375V" for a 230V AC incoming power supply(Default - setting)

"Ucc Brake Resistor On = 375V" for a 400V AC incoming power supply(Default - setting)

"Ucc Brake Resistor On = 375V" for a 480V AC incoming power supply(Default - setting)

**3. Resistance Value:**

The total resistance value is determined by the selection of both the internal and external brake resistor values which are combined to provide the overall parallel resistance.

When the brake resistors deviate from the table "**Selection Brake Resistor**", it should be noted that the minimal external resistance value of the controller is not undercut.

(see ■ [Technical Unit Data](#)).

**4. Rated Power:**

The brake resistor performance rating is determined by the sum of the selected internal and external brake resistor capacity values.

When the brake resistors deviate from the table "**Selection Brake Resistor**", it should be noted that the minimal external resistance value of the controller is not undercut.

(see ■ [Technical Unit Data](#)).



**Note:**

The somewhat similar ratio of Pd – continuous power rating to Pmax – peak power rating is a prerequisite for the correct monitoring of the brake resistor employed in a parallel configuration.

This is guaranteed with the standard design configurations.



Example for 638A:

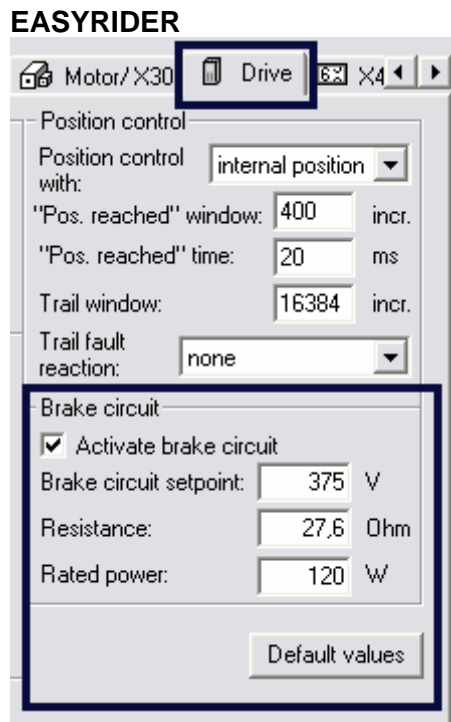

Determination of the resistance values through the employment of both internal and external resistors.

Internal "Brake Resistor = 170 Ohm"

External "Brake Resistor = 33 Ohm"

$$\text{Formula: } \frac{1}{R_{\text{ges.}}} = \frac{1}{R_{\text{int.}}} + \frac{1}{R_{\text{ext.}}}$$

$$\frac{1}{R_{\text{ges.}}} = \frac{1}{170\Omega} + \frac{1}{33\Omega} \Rightarrow R_{\text{ges.}} = 27,6\Omega$$

Selected Resistance Value = **27,6 Ohm**

Determination of the brake resistor rating through the employment of both the internal and external brake resistor ratings

Internal "Brake Resistor Rating = 20 Watt"

External "Brake Resistor Rating = 100 Watt"

$$\text{Formula: } P_{\text{ges.}} = P_{\text{int.}} + P_{\text{ext.}}$$

$$P_{\text{ges.}} = 20\text{W} + 100\text{W} \Rightarrow P_{\text{ges.}} = 120\text{W}$$

Selected Power Rating = **120 Watt**



**CAUTION!**

#### Installation of External Brake Resistors

Brake resistors create heat !

The Brake Resistor must therefore be installed in a manner which provides safeguards against the potential danger of inadvertent touching or the danger of fire, during both normal operations and under fault conditions.

## 6 Wiring Instructions

---

### 6.1 General Wiring Instructions

- **General Information**

Digital servo drives are designed for **operation in metallic grounded enclosures**.  
For problem free operation, as well as for the observance of all regulations,  
the **drive unit back must be connected with the cabinet mounting plate electrically and fixed**.

- **Control Cabling**

Recommended cross section 0,25 mm<sup>2</sup>. The control signal lines must be laid separately from the power signal lines: See “[● Hints for Mounting](#)”

The resolver cable must contain three shielded pairs **and** must be shielded as a whole.  
The shielding should be connected to the ground spread out on the drive side.

We recommend using the resolver cable **KIR**.

Cables utilized for transmitting data must always be shielded !

- **Power Cabling**

Recommended selection according to rated current. Use only 75° Cu-cables.

- **Analog Setpoint**

The setpoint input is a differential input. Therefore the poling can be configured depending upon the application requirements.

Important: the setpoint voltage must be galvanically connected to the reference potential of the control connections (plug X10). It is possible to connect one pole directly to the ground, GND.

- **Safety Rules**



**Caution !**





**Plug / Unplug all mating connector is only allowed :**

- **Power Supply off**
- **Control Voltage off**
- **DC – Link discharge (discharge time > 3 minutes)**
- **The user must ensure protection against accidental touching**

## 6.1 Electromagnetic Compatibility (EMC)

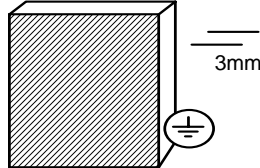
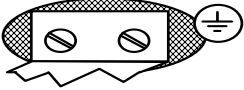
Conformity, in accordance with the EEC Directive 89/336/EEC has been evaluated using a reference-system, consisting of a compact type drive and a line-filter on mounting-plate, connected to an AC-synchronous motor. The motor cable is mainly responsible for EMC emissions. The motor cable must be installed therefore employing exceptional care. The layout of grounding is very important. Grounding has to be low-impedance for high frequencies. That means, all ground connecting parts have to be connected over a large surface contact area. The measurements provided are valid only with the use of our cables, suppression aids and line filters and by application of the following wiring instructions:

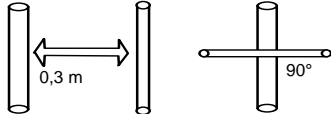
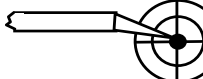
### ● Hints for Mounting

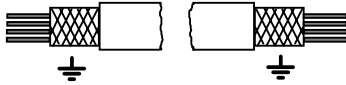
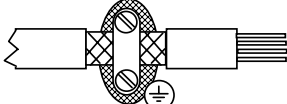
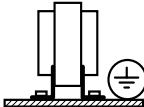
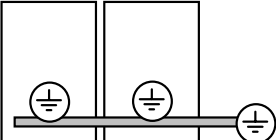
<b>A</b>	All components are mounted inside of a steel control cubicle on a mounting plate (min. thickness 3mm). Recommended: Galvanized	
<b>B</b>	The connection between the drive housing, the filter housing and the mounting plate must be bare metal and not reduced by varnish. All screws must be properly tightened !	
<b>C</b>	Use only our filters and cables for motor and resolver connections.	
<b>D</b>	Place all wires and cables as close as possible to grounded metal parts.	
<b>E</b>	Separate power and control cables. Minimum distance: 0,3m Cross Points: 90°	
<b>F</b>	Avoid cable loops. The run between the line-filter and drive has to be as close and short as possible (drilled).	
<b>G</b>	Maintain the shielding as close as possible to the cable-end (max distance 8 cm).	
<b>H</b>	Connect shielded connections according to general view of connections: See chapter 2.1. Ground shielding on both sides, with the shortest possible cable run. For long cables: Connect additional shielded areas along the way.	
<b>I</b>	Connect the shielded area to well grounded points.	
<b>K</b>	Connect unused wires in cables to the ground.	
<b>L</b>	Install control cables close to grounded metal parts or shielding when leaving the control cubicle	
<b>M</b>	Pay close attention to the grounding of control-transformer (DC 24V). Use a transformer with a metal socket and pay attention to provide for good conductive contact on mounting plate.	
<b>N</b>	Pay close attention to the overall grounding of the complete system. Interconnect several mounting plates using copper rails or copper band. Pay attention to the ground connection between the control cabinet and the equipment !	

## 6 Wiring Instructions

- Example for Mounting

X61 Motor Connector Wiring:

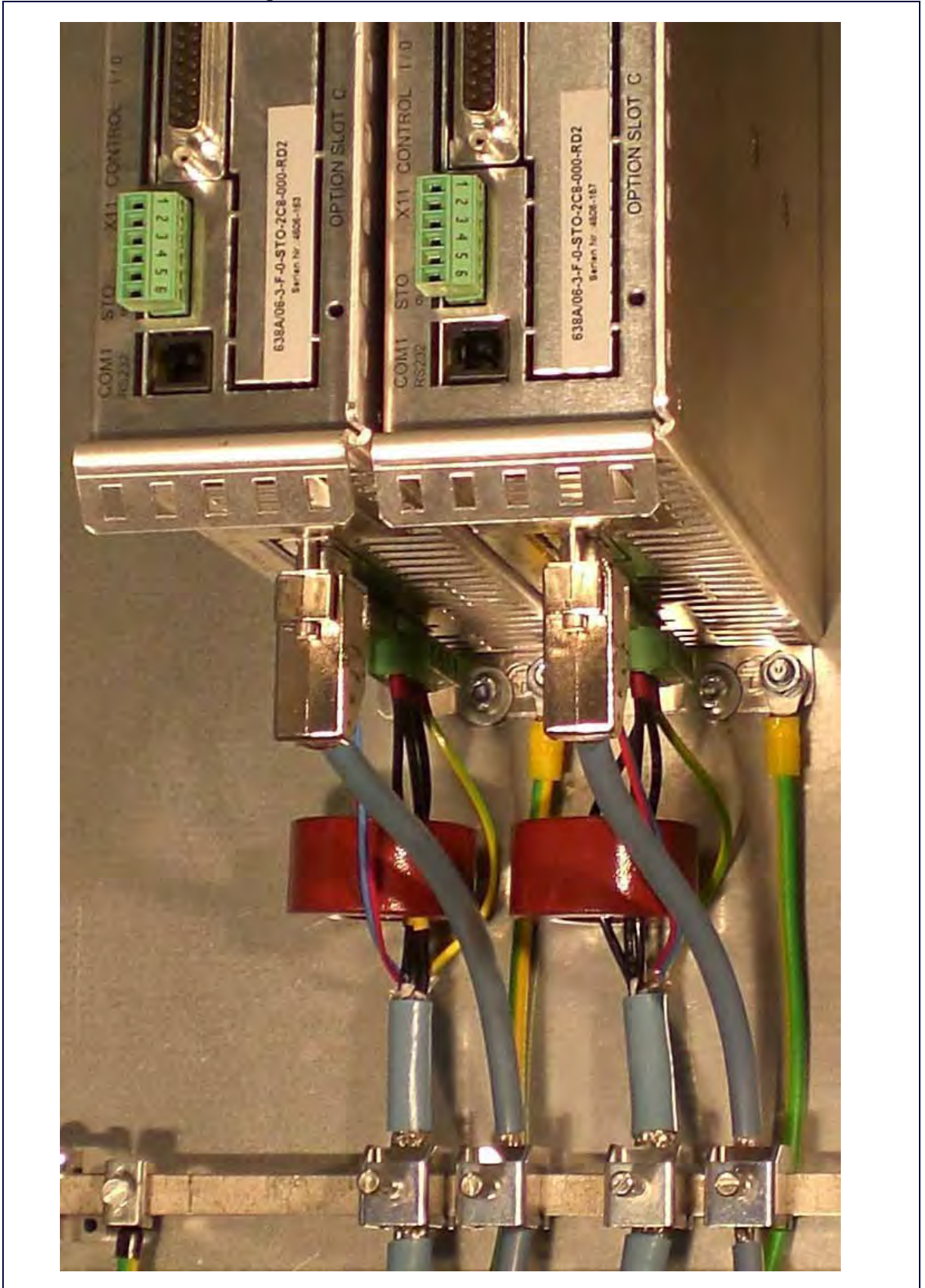

## 7.1 Jumpers

All jumpers are set to a standard preset !

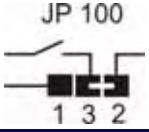
<b>JP100, Bridged Pad</b>		
2 and 3 (standard)	READY contact with reference to common output supply voltage on X10.21	
1 and 3	READY contact can be freely wired	

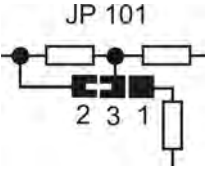
<b>JP101, Bridged Pad.</b>		
2 and 3 (standard)	Analog input X10.19 without internal pull-up.	
1 and 3	Analog input X10.19 with internal pull-up to +12 V	

<b>JP1, JP2, Bridged Pad</b>		<b>Adjust identically !!</b>
2 and 3 (standard)		X10.15 = high active
1 and 3		X10.15 = low active

<b>JP3, JP4, Bridged Pad</b>		<b>Adjust identically !</b>
2 and 3 (standard)		X10.14 = high active
1 and 3		X10.14 = low active

<b>JP2.8, JP2.3, JP2.7, JP2.2</b>		
Open		Default, <b>RP</b> -CAN, -DEV, -2CA, -2C8, -CC8, -CCA, -PDP, -PC8, -PCA,
Close		<b>RP</b> -232, -422, -485, -IBS, -EA5, -SUC

<b>JP600</b>		
Open		Default
Close		Minimal current leakage with external filter operation



# 7 Hardware Configuration

- **Power Board Layout Plan 638A**

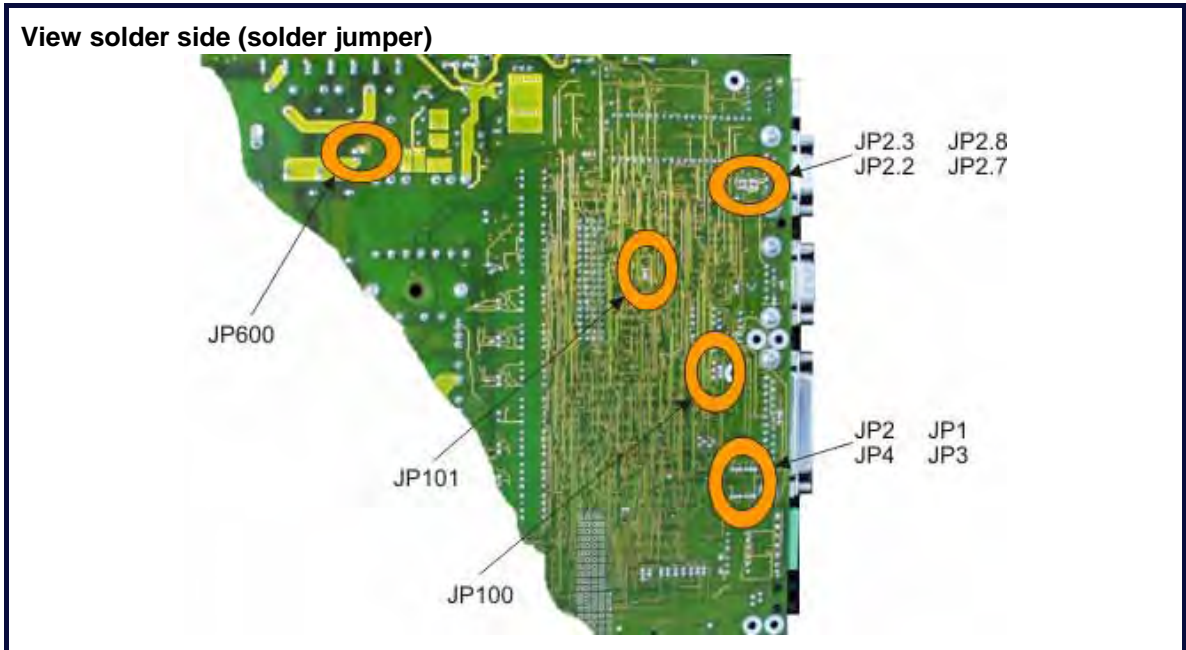

- **Power Board Layout Plan 638B/C**

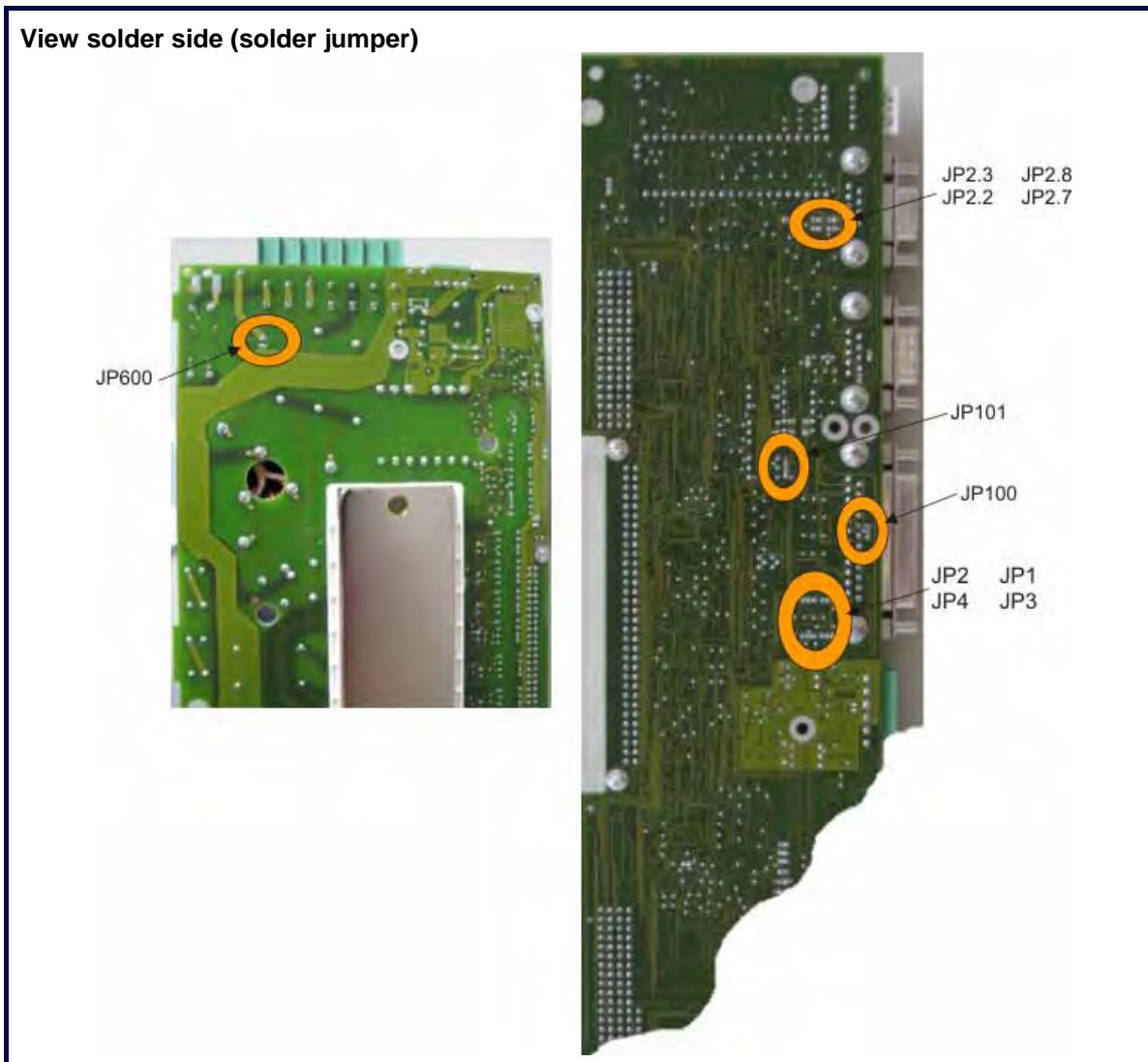



## 8.1 Commissioning Preparation



### Caution !





















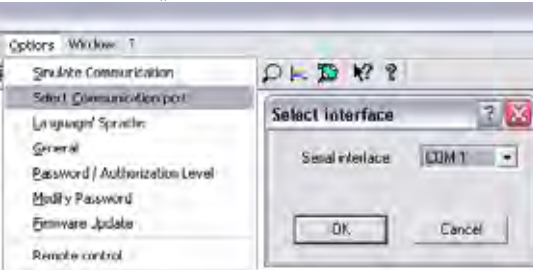

**Improper installation conditions and/or wiring can cause uncontrolled movement and operation of the equipment.**

**Please carefully observe all safety instructions and regulations for the protection of both the equipment and personnel!**

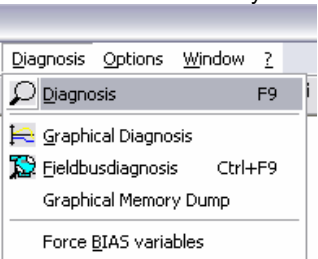





- It is recommended that one utilize the **EASYRIDER®** Windows - Software Program for the initial set-up of the equipment. This program communicates through the serial interface of the computer to the attached drive.  
**Information concerning the operation of the EASYRIDER® software is discussed in this chapter.** We suggest that the software be first run in the "Simulation" mode in order for the user to become familiar with and comfortable the system. The EASYRIDER® Windows - Software also provides for additional interactive "Help" functions.
- Due to security concerns some of the Menus are password protected. The set up and start up of the equipment must be carried out by qualified personnel only.
- The installation must be performed taking into consideration all of the specific safety regulations and security related functions, concerning the equipment. Double check all safety and security related items, including the limit switch.
- The conformity of the motor feedback system and the X300 feedback module built-in to the drive must be checked by examining the name plates on the equipment.
- For the initial equipment start up involving critical applications, we recommend that a test be run without the mechanical connection being made. If problems do arise then they can be solved without risk of damage to any other attached equipment.
- An experienced installer does have the possibility of tailoring the installation to meet the specific application requirements, provided that he/she assumes all of the responsibility for any alterations or deviations from the prescribed installation instructions.

# 8 Commissioning

## 8.2 Step ①: Wiring and Communications Test





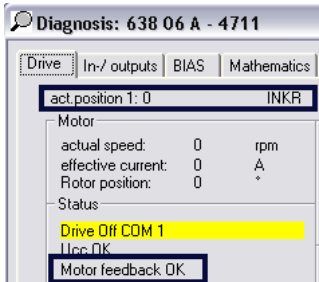

1 	Action, Function	Anticipated Result	Remark, Cause of Fault Condition
1.1 	<b>Before Starting the Equipment!</b> Check the wiring; in particular: supply voltage, incoming powerline, motor wiring, motor polarity, feedback system, (Resolver; HIPERFACE® etc.), polarity Sine / Cosine etc.	-	<a href="#">638 Connector Assignment</a> <a href="#">Electrical Installation Wiring Instructions</a> <a href="#">Model Code</a>
1.2  	First uncouple the motor shaft, before addressing critical mechanical problems.	Limitation of potential danger	
1.3  	Connection of the Diagnostic Interface Link for the Drive - COM1 RS232 Connection to the PC and start EASYRIDER Windows Software. 	EASYRIDER for Windows Software Start side: 	<a href="#">EASYRIDER Software</a>  Cable Interface  USB RS232 Adapter
1.4 	Settings for the Connected COM Ports With the PC in Options Menu→ select „Interface Selection“. 	The selected COM Port is shown on the lower right hand corner of the window of the EASYRIDER for Windows Software 	The available connections to the PC are shown in the Device Manager under System Control 
1.5 	Supply Voltage US = 24V DC through X01-Connection to the system. 	7 Segment Display: 	<a href="#">Pin Assignments for the Power Supply Connection X01</a>  <a href="#">7 Segment Display Symbol:</a>
1.6 	Check the communications connections and functions by utilizing the Diagnosis window or by employing the F9 button on the keyboard. 	EASYRIDER Diagnosis Window: 	It is always the last window where settings have been made which will be opened!
	<b>On to Step ②</b> 	  	

8.3 Step ②. :Feedback Test and Motor Selection





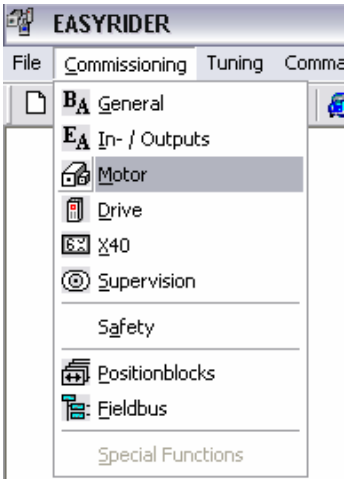
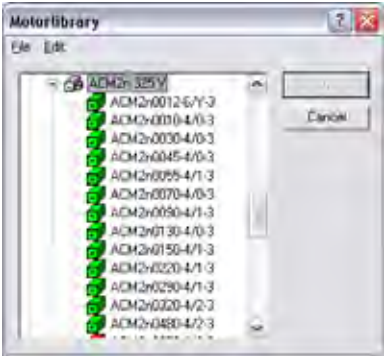
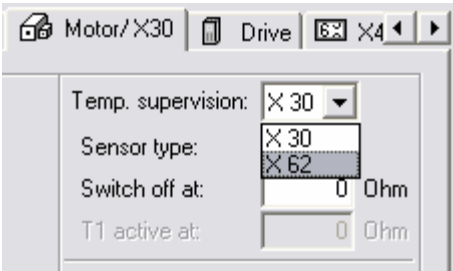

2 	Action, Function	Anticipated Result	Remark, Cause of Fault Condition
2.1.1 	<p><b>Prerequisite:</b> <b>Step ①</b> The feedback sensor is connected to the 638 Drive through the X30 connection port.</p> <p>Optionally. Temperature sensor and/or Brake are connected to the X62 connector. (with X62 Thermo notice <a href="#">Step 2.2.3</a>)</p>	 	<p><a href="#">638 X30 Connector Assignment</a></p> <p><a href="#">638 X62 Connector Assignment</a></p>
2.1.2	 <p>Make the X30 connection to the drive only when the power supply is disconnected!</p>	Eliminate the risk of a short circuit!	
2.1.3 	<p>Check the counter function by looking at the Actual Position Locator – Display 1 under the Drive Diagnosis window of the EASYRIDER Software and the movement of the motor shaft. ∪∪. - with linear motors the movement of the rotor.</p>		<p>When employing a motor with a brake, make certain that the brake is opened</p>

# 8 Commissioning







## ● Step 2.2 Motor Selection

2 	Action, Function	Anticipated Result	Remark, Cause of Fault Condition
<b>2.2.1</b> 	<b>Prerequisite:</b> <b>Step ①</b> The motor cable is connected to the 638 Drive through the X61 connection port 	-	<a href="#">638 X61 Connector Assignment</a>
<b>2.2.2</b> 	In the EASYRIDER configuration menu for „Motor“, select Motor Library and then scroll down to the appropriate motor utilizing the motor type information as listed on the name plate. 		When employing motors from other manufacturers it is possible to input and store the specific motor characteristics in the Customer Motor Library.
<b>2.2.3</b>	Optionally: select temperature sensor 	Select the temperature sensor connection X30 or X62 in EASYRIDER.  Default : X30	<a href="#">638 X30 Connector Assignment</a> or <a href="#">638 X62 Connector Assignment</a>
<b>2.2.4</b>	In the EASYRIDER configuration menu for „Motor“, send the selected motor information on to the drive and save the selection.	-	







- **Step 2.3 Motor with Resolver Feedback**

2 	Action, Function	Anticipated Result	Remark, Cause of Fault Condition
2.3	With standard motors, equipped with Resolver Feedback, when the unit is properly wired and the proper motor is selected, no additional action is required. For every 360° motor shaft turn a position value of $2^{16} = 65536$ pulses is sensed.		
	On to <b>Step ③</b> 	  	

- **Step 2.4 Motor with HIPERFACE Feedback**

2 	Action, Function	Anticipated Result	Remark, Cause of Fault Condition
2.4	<p>The characteristics of the HIPERFACE – Feedback System, as the absolute measuring device (multi-turn provider), allows for 2 additional parameter settings.</p> <ol style="list-style-type: none"> <li>1. Selection of the position location, per rotation 16 or 20 bit.</li> <li>2. Selection of the absolute position value according to the connection between the motor and the mechanical component.</li> </ol> <p><b>Note:</b> It is necessary to initially provide the angular commutation parameter value as the absolute value for the HIPERFACE provider, when employing a motor from another manufacturer with HIPERFACE- Feedback</p>		
	On to <b>Step ③</b> 	  	









- **Step 2.5 Motor with SIN-COS Feedback Linear Motor**

2 	Action, Function	Anticipated Result	Remark, Cause of Fault Condition
2.5	Additional settings are required with the employment of this variation, which are described in the following section: <a href="#">Step 4.2. Optimization Linear Motors</a> .		
	On to <b>Step ③</b> 	  	





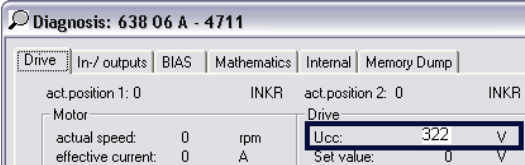







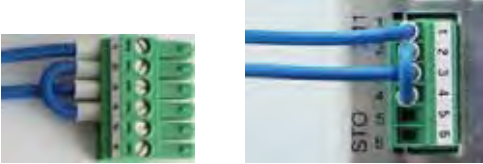

# 8 Commissioning

## 8.4 Step ③: Power Up and Drive Activation

### ● Step 3.1 Power Up

3 	Action, Function	Anticipated Result	Remark, Cause of Fault Condition
3.1.1 	<b>Prerequisite:</b> <b>Step ① + ②</b> The power supply is connected to the X60 connection of the 638 Drive. 	-	<a href="#">X60 Connector Assignment</a>
3.1.2	 Establish the X60 connection, when lacking, only when the drive system is not connected to the power supply!	In order to eliminate the risk of a short circuit!	
3.1.3	 Terminals 1 and 4 on the X11 STO connection should be set at 0 V. 	The drive remains in a non-activated condition even after the power is connected.	<a href="#">X11 Connector Assignment</a> <b>STO = Safe Torque Off</b>
3.1.4 	Turn on the power and check the voltage in the Drive Diagnostic Menu. 	The drive will show a DC link voltage Ucc of approx. 325 V DC with an incoming supply of 230 V AC, in a non-activated condition.	7 Segment Display: 













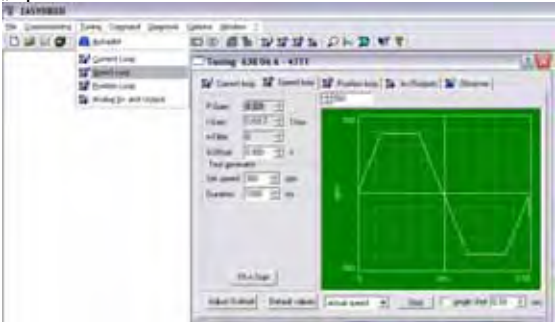

### ● Step 3.2 Drive Activation

3 	Action, Function	Anticipated Result	Remark, Cause of Fault Condition
3.2.1	 It is necessary to make additional settings as described in <a href="#">Step 4.2 Optimization Linear Motor</a> , when employing a motor with a Sin/Cos Feedback system.	In the event that the Feedback System = Sin/Cos On to <a href="#">Step 4.2</a>	
3.2.2	Terminals 1 and 4 on the X11 STO connection should be set at 24 V. 	Driver – power stage is activated and the 7 segment display shows:  The drive is now set in the operations mode (Delivery condition; Speed control set to the analog setpoint)	<a href="#">X11 Connector Assignment</a> The motor shaft can be set to turn slower through the 0-V offset setting of the analog setpoint input.
	In the event that no fault condition arises <b>On to Step ④</b> 	  	
	 Further function test from the STO – terminal, as per statement in chapter <a href="#">Safe Torque Off</a> .		
Other- wise 3.2.3	 With unanticipated operation or overheating of the motor, turn off the drive and attempt to locate the cause of the problem. Identify and rectify the fault condition.		<a href="#">Diagnosis and Troubleshooting</a>
	and perform <b>Step ③</b> again 		

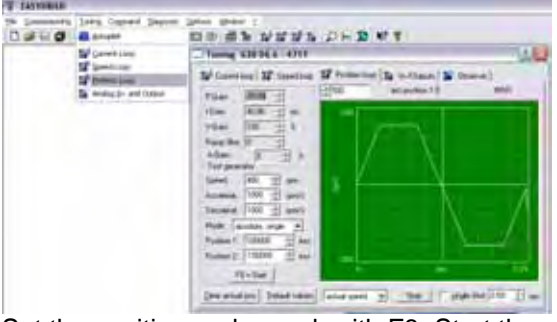

8.5 **Step ④: Control Loop Optimization**









- **Step 4.1 Control Loop Optimization with Rotary Motors**

4 	Action, Function	Anticipated Result	Remark, Cause of Fault Condition
4.1.1	<b>Prerequisite:</b> <b>Step ①+②+③</b>	  	
4.1.2 	<p>In the EASYRIDER Commissioning Menu select „Speed Controller“</p>  <p>and with F8=Start the Test Generator.</p>	<p>Check the speed and power variation characteristics utilizing an oscilloscope and through the adjustment of the P and I sections set the parameters for the control rigidity.</p>	
4.1.3  	<p>Attach the mechanical component with the motor shaft.</p>		
4.1.4	<p>Perform step 4.1.2 again</p>	<p>Pay attention with linear motion! The speed generator is controlled by time and recognizes no parameters unless the limit switch is configured!</p>	
4.1.5 	<p>Within the EASYRIDER Commissioning Menu select „Position Control“, when employing the position control settings.</p>  <p>Set the position and speed, with F8=Start the Test Generator.</p>	<p>Check the speed, power variation and control deviation characteristics utilizing an oscilloscope and through the adjustment of the P, I and V sections set the parameters for the power control rigidity.</p>	
	<p><b>On to Step ⑤</b> </p>	  	











## 8 Commissioning

---

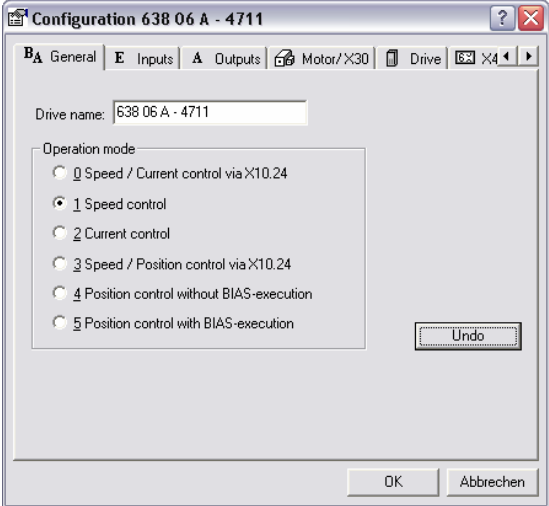
- Step 4.2 Control Loop Optimization with Linear Motors











Step	Action, Function	Anticipated Result	Remark, Cause of Fault Condition
4.2.1	Prerequisite: <u>Step</u> ① + ② + ③	  	
	<b>Under Construction!!!</b>		
	On to <u>Step</u> ⑤ 	  	

8.6 **Step ⑤: Operation Mode Selection**







5 	Action, Function	Anticipated Result	Remark, Cause of Fault Condition
5.1	<b>Prerequisite:</b> <b>Step ①+②+③+④</b>	  	
5.2 	<p>In the EASYRIDER configuration menu, select „General“ and then select the appropriate operating mode.</p> 	<p>With the selection of the operating mode, one must also select additional settings.</p> <p>For example:</p> <ul style="list-style-type: none"> <li>* On/Off Configuration</li> <li>* Analog Setpoint Selection and Integrator</li> <li>* Position Blocks</li> <li>* BIAS Program</li> <li>* Fieldbus Interface</li> </ul>	<p>Additional information and assistance is available through the utilization of the online help for EASYRIDER Software.</p>
	<b>On to Step ⑥</b> 	  	

## 8 Commissioning

### 8.7 Step ⑥: Fieldbus Interface

6 	Action, Function	Anticipated Result	Remark, Cause of Fault Condition
6.1	Prerequisite: <u>Step ① + ② + ③</u>	  	
6.2 	The overall system commissioning and the communications test of the fieldbus interface are dependent upon the interface configuration of the drive. If there is not an options board connected then there are no more additional settings required, and one can move on to Step 7.		
6.3. 	In the configurations menu, under „Fieldbus“ additional settings may be required, depending upon the connection interface for the fieldbus board.	Additional information concerning start up procedure for the fieldbus interface connection can be found in the handbook about the Options Board.	
	On to <u>Step ⑦</u> 	  	

8.8 Step ⑦: Data Save

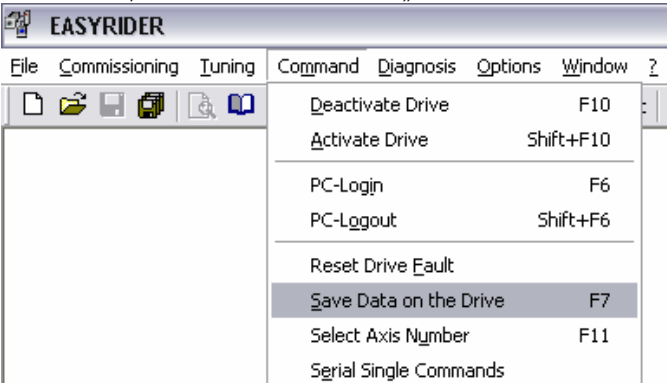
7 	Action, Function	Anticipated Result	Remark, Cause of Fault Condition
7.1	<b>Prerequisite:</b> <b>Step ①+②+③+④+⑤+⑥</b>	  	
7.2 	<p>Read the parameters shown in the EASYRIDER Data Menu under „Drive Parameters“.</p> 		
7.2 	<p>In the Menu, under commands select „Save Data on the Drive“</p> 		

## 8 Commissioning

7.3

In the Menu under Data, select „Save As“ , to save the drive parameters on the computer, utilizing the file suffix \*.wdd .

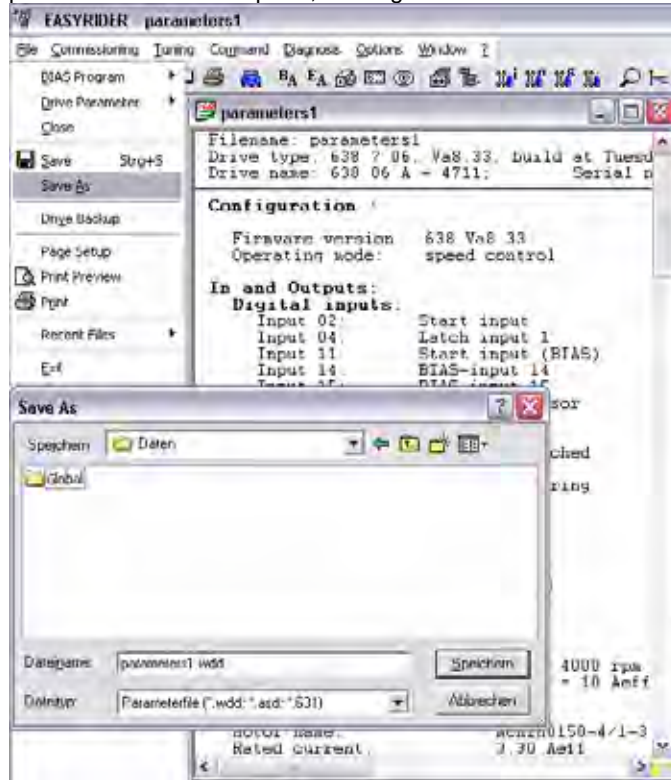

First system start up procedure

**Steps ①+②+③+④+⑤+⑥+⑦**  
successfully accomplished.





## 9.1 General Introduction

The following documentation is meant to provide the basic information concerning our drive controller and an understanding about the advanced, safety oriented machine construction. References to standards or other regulations are made in a general overview manner. The specific standards or regulations for your installation will vary depending upon the equipment employed and the specifics of your application.

For more information we suggest referring to specific technical literature, for example: BIA-Report 6/97 and BIA-Report 5/2003 (Information of the German Professional Trade Association).

These reports can be downloaded from: <http://www.hvbg.de/d/bia/pub/rep/index.html>

### ● Important Technical Terms and Explanations

Term	Explanation
<b>Safety Category 3 Performance Level d according to EN 13849-1</b>	<b>Definition according to the regulation:</b> Circuit with built-in protective functions for individual fault conditions. Some, but not all faults will be recognized. The frequent occurrence of fault conditions can lead to a loss of the safety functions. The remainder of the risk must be understood and accepted. The determination for the application of the appropriate safety category requirements, (risk analysis), lies with the installer and operator of the equipment. You can reference the method described in EN13849-1:1996, Appendix B, as an example.
<b>Safety Category 4 Performance Level e according to EN 13849-1</b>	<b>Definition according to the regulation</b> The safety related parts must be designed in a way, that a single fault condition in each safety related part will not guide to loss of the safety function and the single fault will be detected before or on next demand of the safety function. If this is not possible, an accumulation of faults should not lead to the loss of the safety function. The determination for the application of the appropriate safety category requirements, (risk analysis), lies with the installer and operator of the equipment. You can reference the method described in EN13849-1:1996, Appendix B, as an example.
<b>‘Safe Stop’ or alternatively: ‘Safe Torque Off’ or abbreviated as: STO</b>	With the activation of “Safe Torque Off”, the energy supply to the drive is definitively interrupted, according to the requirements of EN1037, section 4.1. The drive unit is not allowed to rotate and will therefore not be able to generate any dangerous rotational movements, (See EN 1037, section 5.3.1.3). The stopping position must not be monitored. Should there be the potential of an outside energy source affecting the drive and STO function, for example the dropping of a hanging load, then additional action needs to be taken to guarantee that no additional movement takes place, (i.e. installation of a mechanical brake).  The following measures are appropriate for incorporation with “Safe Torque Off”: - Protection between power connection and the drive system (Line Fault Protection) - Protection between the power unit and the motor (Motor Protection) - Protected lock of the control of the solid state power component ( Start-up Lockout)
<b>Start-Up Lockout</b>	Protected lock of the control of the solid state power component. With help of this function one can establish the activation of the “Safe Torque Off”.

## 9 Safe Torque Off (STO)

- **Stop Category according to EN 60204-1 (Chapter. 9.2.2)**

Stop Category	Requirement	System Reaction	Note
0	Shutdown by immediate shut-off of power supply to the machines' driving components	Uncontrolled Shutdown	Uncontrolled shutdown is the stopping of the machines' movement by eliminating the power supply to the power components of the machine. Available brakes and/or other mechanical braking systems should be employed.
1	Shutdown, by a means which maintains the power supply connection to the machine drive component, to bring movement to a standstill. The power connection will be broken only after standstill has been achieved.	Controlled Shutdown	Controlled shutdown is the stopping of the machines' movement by for example, the setback of the electronic command signals to zero as soon as the stop signal is recognized by the controller, while the power supply to the machine drive components remains intact until a standstill condition is achieved.
2	Shutdown, by a means which maintains the power supply connection to the machine drive component.	Controlled Shutdown	This category will not be covered in the functions description of the manual.

- **Applications in Accordance with the Regulations**

The 638 Drive supports the safety function “Safe Torque Off”, in the sense of providing a definitive stopping of the equipment, with protection against unanticipated start-up, in accordance with regulations EN ISO 13849-1, Category 4, Performance Level e and EN 1037.

The motor must stopped controlled through the machine controller. However, it does not provide for any verification of cessation of movement which may have been produced from some external source. One must pay specific attention to the vertical axes, without a mechanical self-inhibitor or balanced weight.

According to Machine Regulations 89/392/EWG, i.e. EN 292; EN 954 und EN 1050, when considering the safety and risk analysis, the machine constructor is responsible to make certain that the overall safety system for the whole machine takes all of the integrated components into consideration. Note that the electrical drives must also be included in this consideration.

One must pay attention to and follow the instructions completely as stated in the validation report, with regard to the initial start-up, service intervals, troubleshooting and repair of the equipment. The STO conformance protocol outlines a suggestion for the documentation of the relevant safety parameters in the validation report.

- **Trained Personnel**

Planning, installation and initial system commissioning require a detailed understanding of this information.

Protective safety standards and risk mitigation issues which are connected to the specifics of the installation must be recognized and taken into consideration, as well as appropriate actions to be taken in the event of an emergency.

- **Benefits with the Employment of the Safe Torque Off Function**







**Safety Category 4 performance Level e according to EN 13849-1:**

<b>Performance Feature Requirement</b>	<b>Application of the Safe Torque Off Function</b>	<b>Conventional Solution : Utilization of External Switching Components</b>
<b>Reduced Switching Effort</b>	Simple circuitry, certified application examples The grouping of multiple drives together on a main contactor is possible.	Two safety-oriented performance protections in series connections required.
<b>Application in Production Processes</b>  <b>High Switching Frequency, High Reliability, Less Wear</b>	Extremely high switching frequency through the use of almost wear-free technology (Low voltage relays and an electronic switch). The condition “Safe Torque Off” is achieved through the use of a wear-free electronic switches (IGBT’S).	This performance feature is not achievable through the employment of conventional technology.
<b>Application in Production Processes</b>  <b>Faster Reaction Time, Faster Re-Start</b>	The drive remains power and control related in a connected condition. No significant wait time with re-start.	With the utilization of power contactors on the incoming power line, a long wait time is required for the energy discharge from the DC link.  With the use of two motor side power contactors, it is possible to increase the reaction time, however one must recognize the potential disadvantages:: a) Make certain that switching occurs only in a power free condition, (DC Power! Prevent arcing). b) Increased cost for EMC conforming cabling.
<b>Emergency Stop Function</b>	According to the German Edition of the Standards: Permissible without mechanical power switch element activation 1)	Shutdown employing a mechanical switching element is required.

1) According to the forward of the German edition of the standards EN 60204-1/11.98, electronic equipment for use with the emergency stop mechanism is acceptable, as long as the requirements in the safety categories, like those required in EN13849-1, are completely observed.

## 9 Safe Torque Off (STO)

- **Safety Instructions and Limitations**

	<p><b>No Galvanic Separation of the Outputs</b>            The galvanic separation does not occur through the starting lockout function. This therefore does not in any way provide protection against an “electrical spike”.            For operation interruptions, maintenance, service and cleaning of the equipment, the entire system must be definitively and galvanically separated from the power supply at the main switch box and confirmation should be made that the system can not restart (See EN 60204-1;5.3).</p>
	<p><b>Potential Sudden Jerking or Movement under Fault Condition</b>            In the event that two fault conditions appear at the same time in the power unit, it is possible that unit may exhibit a sudden jerking or movement within a small angle of rotation. This is dependent upon the number of pole pairs of the motor. (Rotary Type:2-pole = 180°, 4-pole = 90°, 6-pole = 60°, 8-pole = 45°; Linear Motors: 180° electric).</p>
	<p><b>Malfunction during the Active Braking Phase with Stop Category 1; EN 60204-1</b>            (controlled stop with reliable monitored time delay)            If a fault in the drive system occurs during the active braking phase, the axel can coast to a stop, uncontrolled or in the worst case continue to operate until the expiration of the predetermined shut-off time.</p>
	<p><b>Hanging Loads or Influencing External Forces</b>            In the event of a power failure the hanging loads can possibly fall in an uncontrolled manner endangering people or equipment. The operation of hanging axes therefore requires special attention relating to risk analysis and mitigation with hanging loads.</p>
	<p><b>Not for Use in Drive Applications in Field Weakening Operation Ranges!</b>            With motors which are employed in field weakening operation ranges, it is important to note that the operation of the STO function can be adversely affected, specifically involving an uncontrolled increase in rotational speed, life threatening over voltage and explosion of the drive unit!</p>
	<p><b>Minimal request of safety function</b>            The safety function STO must activate for at least weekly.</p>
	<p><b>Acknowledgement</b>            The configurable acknowledgement is only permissible with category B.</p>

9.2 Safe Torque Off Function, (STO)

General

The electricity flow to the motor windings is controlled through a solid state power component bridge (6-times IGBT). A microprocessor switch with PWM logic switches the IGBT's rotating field orientation. Optical couplings are employed between the control logic and the power unit to provide for electrical isolation.

The [X11 Connector Plug \(STO\)](#) is located on the front of the drive unit. This connector plug is controlled utilizing two optical couplings which communicate over **two channels** through terminals **STO1#** and **STO2#**, and which in a controlled condition supplies the PWM optical coupler with control of the solid state power component.

A test takes place to determine the condition of the input channels. Within the given window of time the condition of both channels must be identical. In the event that a fault condition exists, (different signals from STO1# and STO2#), then the coupling power supply is shut-off and a signal is sent to the 7 segment display.

The re-activation of the power supply to the coupling is then only possible by performing a hardware reset, by turning the equipment off and then back on again.

In addition to the description of the hardware based shut-off through the two channel communication, the internal unit processor provides for a software based shutdown of the PWM circuit. The PWM circuit can be set for time delayed activation, after the recognition of the activation

of both STO inputs, through the programming of the safety parameters for the **active time delay**.

- Block Circuit Diagram

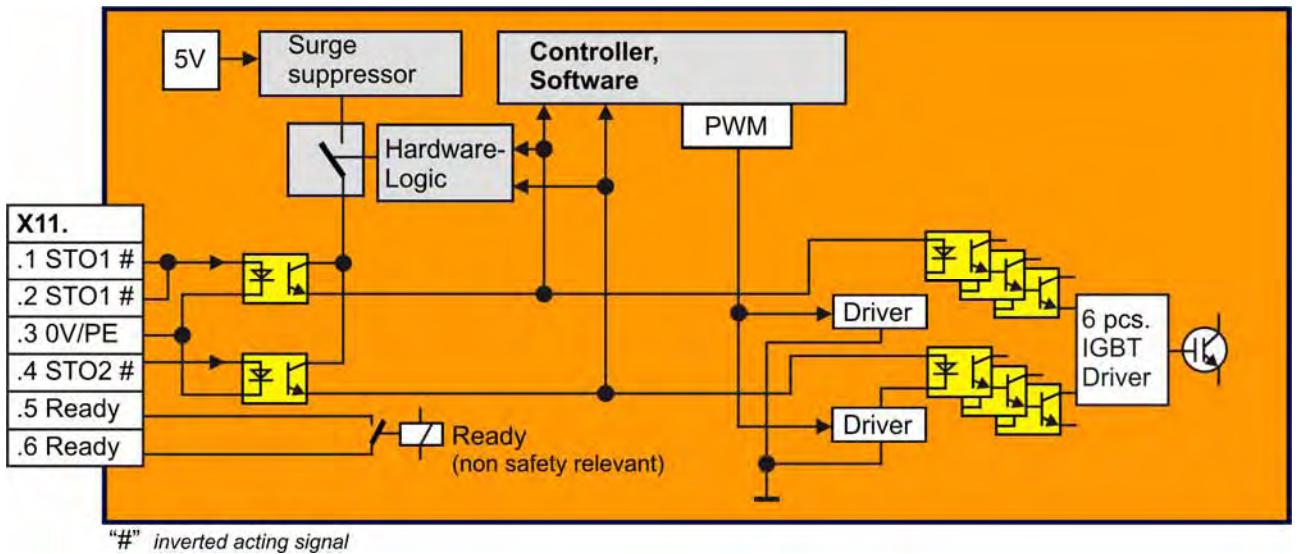

## 9 Safe Torque Off (STO)

- **Status Diagram and Function of Terminals STO1# und STO2#**

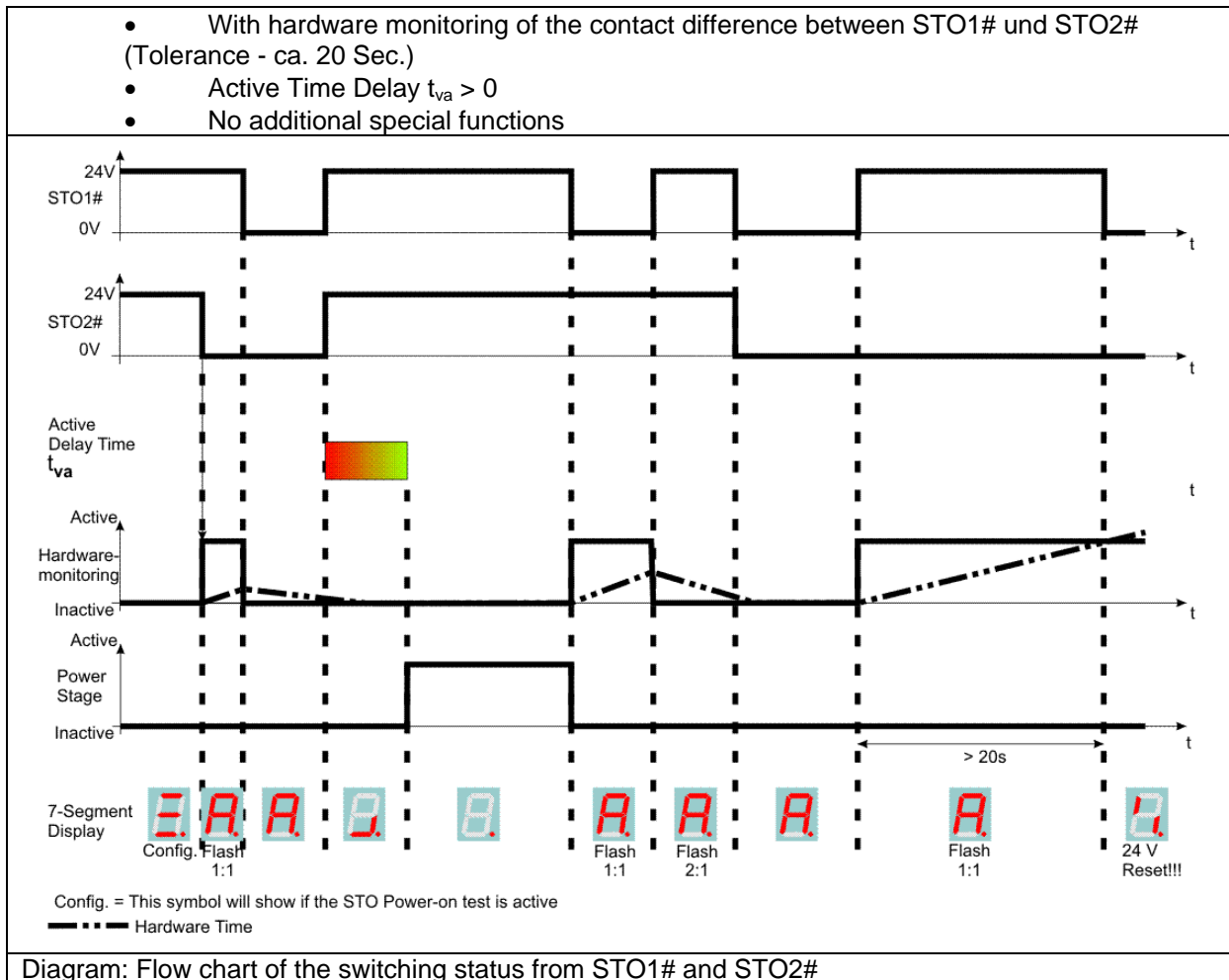

### Note for Standard Operation:

- The STO inputs should always be operated simultaneously.  
If the safety parameter **Active Time Delay** is  $t_{va} = 0$  s, then both STO inputs will be turned on immediately after recognition.



9.3 Configuration and Parameter Settings

• General Instructions for Parameter Settings

The safe torque off, 'STO', basic function is a built-in, hardware oriented safety function which is **not configurable**.



Depending upon the specific application however, it is possible to alter specific settings on the drive

side which can increase the operational safety factor.

The configuration and programming of the safety parameters can be accomplished utilizing the Diagnosis and Parameter Setting screen in EASYRIDER for Windows.



This configuration process has been designed to assist the user in making the proper parameter settings, in an attempt to eliminate the potential for systematic programming errors and/or improper parameter settings.

Required Actions for the Configuration of Relevant Safety Parameters	
	<ul style="list-style-type: none"> <li>• Special password protected access is required to reach the relevant safety parameter setting screens.</li> <li>• The transmission of the data through the PC interface follows a specially designed protected procedure, including: CRC check, drive specific password and a double confirmation and acknowledgement process for the parameter values entered.</li> <li>• After the confirmation and acknowledgement of the entered data, the parameter values are saved in the drive and protected even in the event of a power loss.</li> <li>• The parameter values are stored twice within the drive, and provide for automatic periodic verification of the memory cell accordance.</li> <li>• Any other means of accessing the safety and security related data, as described here, is not permitted.</li> <li>• The creation of a parameter protocol, which can be stored as a document with appropriate name and date information.</li> </ul>

	<p>The relevant safety, secondary function parameters – Acknowledgement and Active Time Delay, can only be set within the Configuration Safety dialog box. The data are saved under Parameter Data utilizing the suffix *.WDD. But the safety relevant data will not transmit by “Transmit Parameters”.</p> <div style="border: 1px solid gray; padding: 10px; margin: 10px auto; width: fit-content;"> <p><b>Safety parameter</b></p> <div style="display: flex; align-items: center;">  <div style="margin-left: 10px;"> <p><b>NOTE!</b> The safety parameter will not be transmit (for safety reasons) Editing this parameter is possible via the safety dialog, only.</p> </div> </div> <p style="text-align: center;">CONTINUE?</p> <div style="display: flex; justify-content: center; gap: 20px;"> <input type="button" value="Yes"/> <input type="button" value="No"/> </div> </div> <p>In the Configuration Safety dialog box the relevant safety parameters will be shown by an open parameter file. The user has to transmit the parameter safely to the drive.</p>
---	---

## 9 Safe Torque Off (STO)

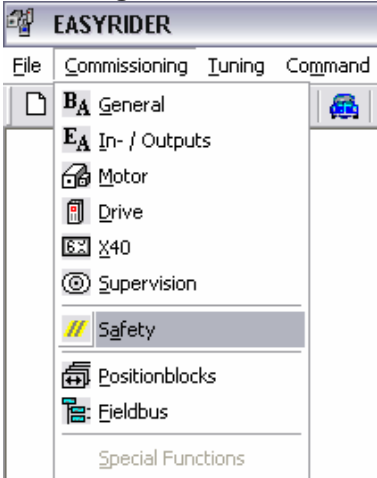
- EASYRIDER Safety Parameter Data Entry Dialog Boxes

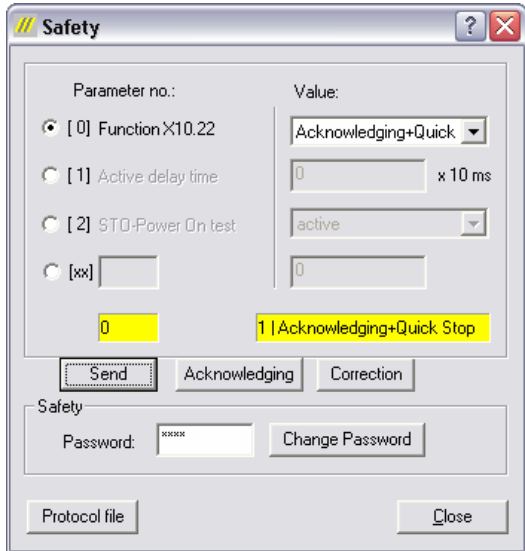
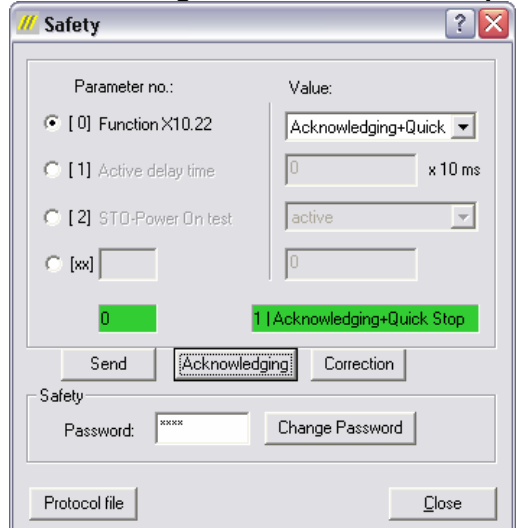
<p><b>1. Commissioning menu - select "Safety" :</b></p> 	<p><b>2. Access password - enter "BGSM"</b></p>  <p>and verify with "OK"</p>
<p><b>3. Enter <u>Safety Password</u>, select Parameter Nr. and enter the appropriate Value</b></p> 	<p><b>4. Send the Parameter - press "Send" one time</b></p> 
<p><b>4. When the yellow display is correct - press the "Acknowledge" button twice to accept</b></p> 	<p><b>5. When the parameter display is green, it confirms that the value is correct, has been stored and power loss protected in the drive unit!</b></p> <p>Once all of the relevant safety data parameters have been entered, then it is possible to call up the protocol form of the actual safety parameter settings by pressing the "Protocol file" button. (ACROBAT Reader is required!)</p> <p><b>Note:</b> A copy of the <a href="#">Safety-Parameter-Protocol Form</a> is available in the appendix of the Servo Drive Handbook and can be used for verification purposes.</p>



- **Safety Parameter List**

The following safety functions are presently able to be configured:

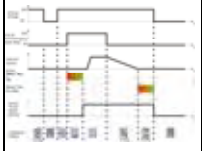
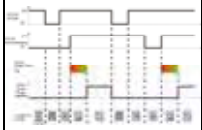
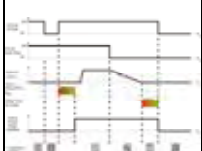
- **Parameter 0: Function Input X10.22**
- **Parameter 1: Active-Time Delay**
- **Parameter 2: STO-Power-On-Test**

Parameter 0	Value Range	Explanation	Note	Flow Chart
<b>Function X10.22</b>	<b>Without Function</b>	No safety relevance. Function X10.22 is freely programmable (BIAS) Initial Factory Settings (default values)		
	<b>Acknowledgement + Emergency Stop</b>	STO-function activation through additional low→high edge of the X10.22 input acknowledgement and Emergency Stop before the STO shutdown through additional high→low edge of the X10.22 input.	See below	
	<b>Acknowledgement</b>	STO-function activation through additional low→high edge of the X10.22 input acknowledgement.	After the recognition of the edge – the active time delay will be started!	
	<b>Emergency Stop</b>	Before the STO shutdown through additional high→low edge of the X10.22 input.	After the recognition of the edge, when the rotational speed =0 then the emergency stop ramp will be executed and when the rotational speed =0, the time delay for the brake will be started!	

Parameter 1	Value Range	Explanation
<b>Active-Time Delay</b> (in 10 ms increments)	4 Initial Factory Settings (Default Value) 4- 500 (*10 ms)	Time delay for the activation of the final stage after acknowledgement (24 V) of both STO inputs, for example of the acknowledgement inputs (in the event that they have been configured).  Note: If the STO inputs, for example, the acknowledgement inputs are removed (0V) before the expiration of the active time delay, then the time will be reset and only reactivated with a new edge (24 V).

Parameter 2	Value Range	Explanation
<b>STO-Power-On-Test</b>	activate (0),(default) deactivate (1)	The STO-Power-on-Test does not allow by deactivated STO (STO1# and STO2# High) to activate the drive. The 7-Segment-Display shows  . The drive will able to activate after the safety function STO was activated  and is deactivate. The safety function could activated by a safety gate or an emergency stop It is possible to use a PLC to automate this test.

## 9 Safe Torque Off (STO)

- **Safety Password**

The safety password must be entered in the appropriate field, every time that the Safety Parameter Configuration screen is selected.

The password is always comprised of 4 letters.

The difference between large and small case letters is recognized.

The drive side initial factory setting of the password is **"SAFE"**.

The responsibility to set the new safety password lies with the operator of the equipment.

The new safety password should only be shared with authorized personnel, for example: anyone who works on the STO, and/or has responsibilities in the areas of equipment operating guidelines or equipment safety and security.

### Flow Chart Diagram: Function X10.22 Acknowledgement + Emergency Stop

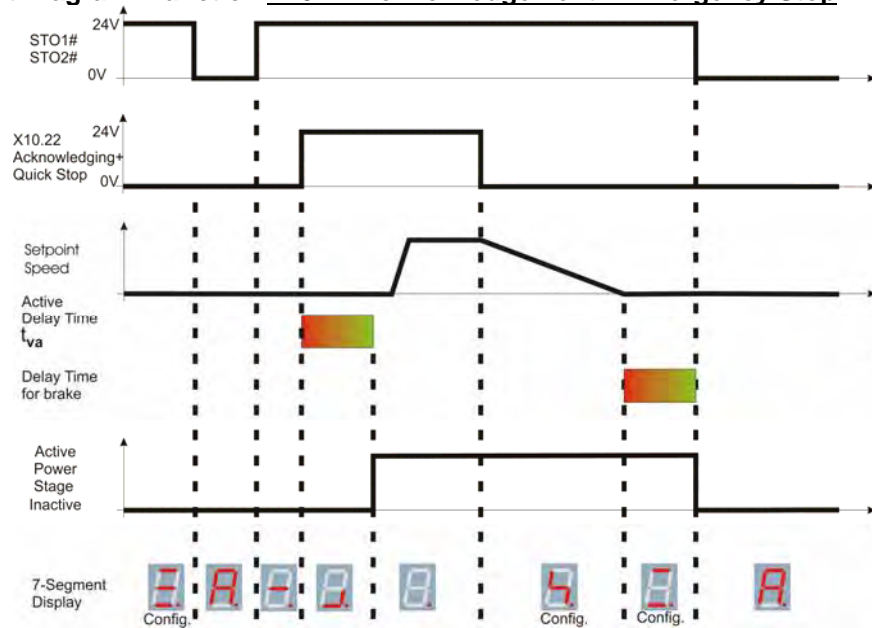

### Flow Chart Diagram: Function X10.22 Acknowledgement

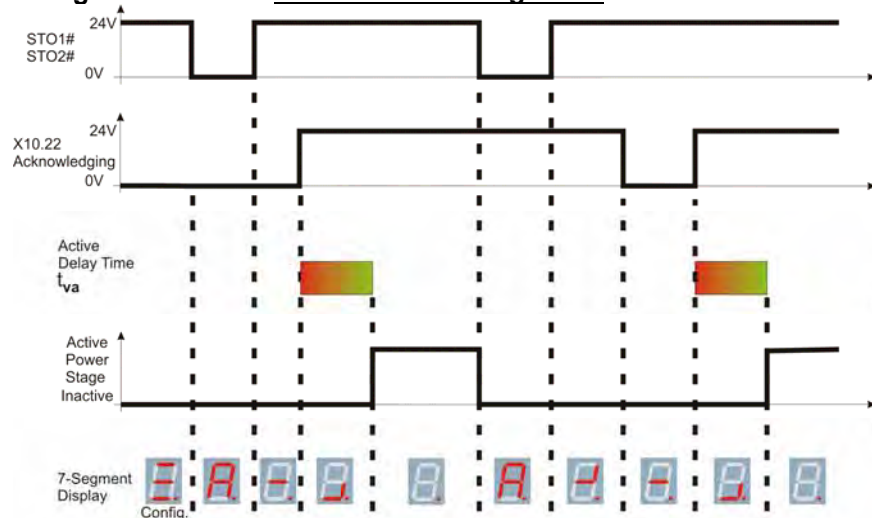

Flow Chart Diagram: Function X10.22 Emergency Stop

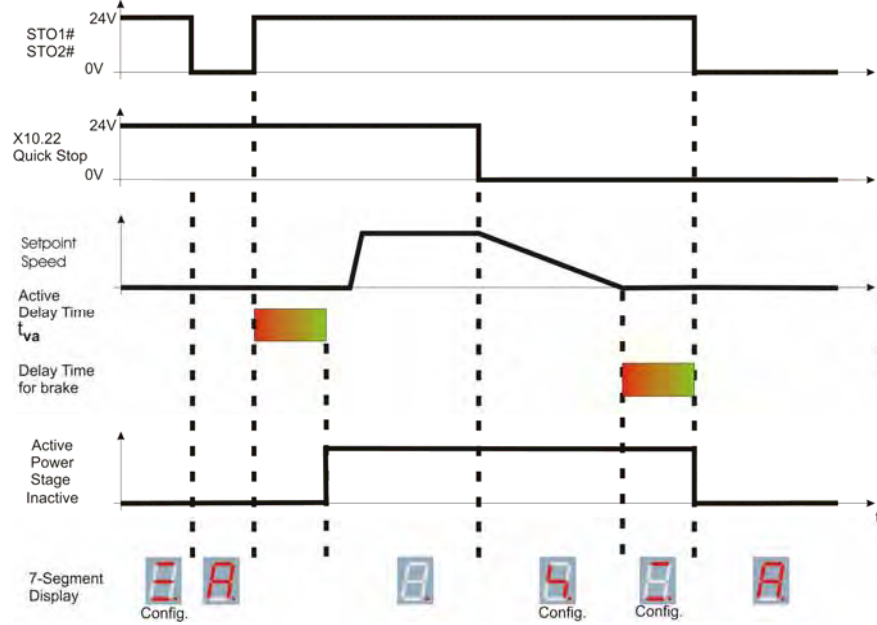

## 9 Safe Torque Off (STO)

### 9.4 Application Example of STO (Safe Torque Off)

Example	Function
<a href="#">Application Example 1</a>	Safety door monitoring or emergency shut-down with protection monitoring switch
<a href="#">Application Example 2</a>	Safety door monitoring or emergency shut-down with protection monitoring switch and time delay
<a href="#">Application Example 3</a>	Safety door monitoring or emergency shut-down WITHOUT protection monitoring switch
<a href="#">Application Example 4</a>	Safety door monitoring or emergency shut-down with protection monitoring switch and time delay of several drives

#### Minimal request of safety function (from Cat. 3 and PL d)



The safety function STO must activate for at least weekly.

This request is very important for application continuous operation and is satisfied by opening the guard door and activating the emergency stop. If the Safe Torque Off is activated very often, additional measures are not necessary.

(Only if the Guard door and/or the emergency stop is connected directly or via safety unit at the 638 X11).

#### Additional Minimal request of safety function by Cat. 4 and PL e



The category 4 and PL e can only be attained if the STO-power on test is enabled.

The STO-power on test needs low-level at both STO# inputs by switch on the 24V control voltage. The drive can not activate if one or both STO-inputs have high-level. The function must be configured in the Safety-Dialog parameter 2 (default Active).

These minimal requests are necessary to detect a failure. Failure detection is only possible if the safety function is activated.

Both measures could be executed by a PLC.



● **Application Example 1**

Function/Action	Response	Protection Level EN 954-1	ISO 13849-1	Stop Cat. According to EN60204
Safety door monitoring or emergency shut-down with protection monitoring switch	The ,STO' is tripped when the safety door is opened or emergency shut-down switch is activated.	Cat. 4	PL e	0

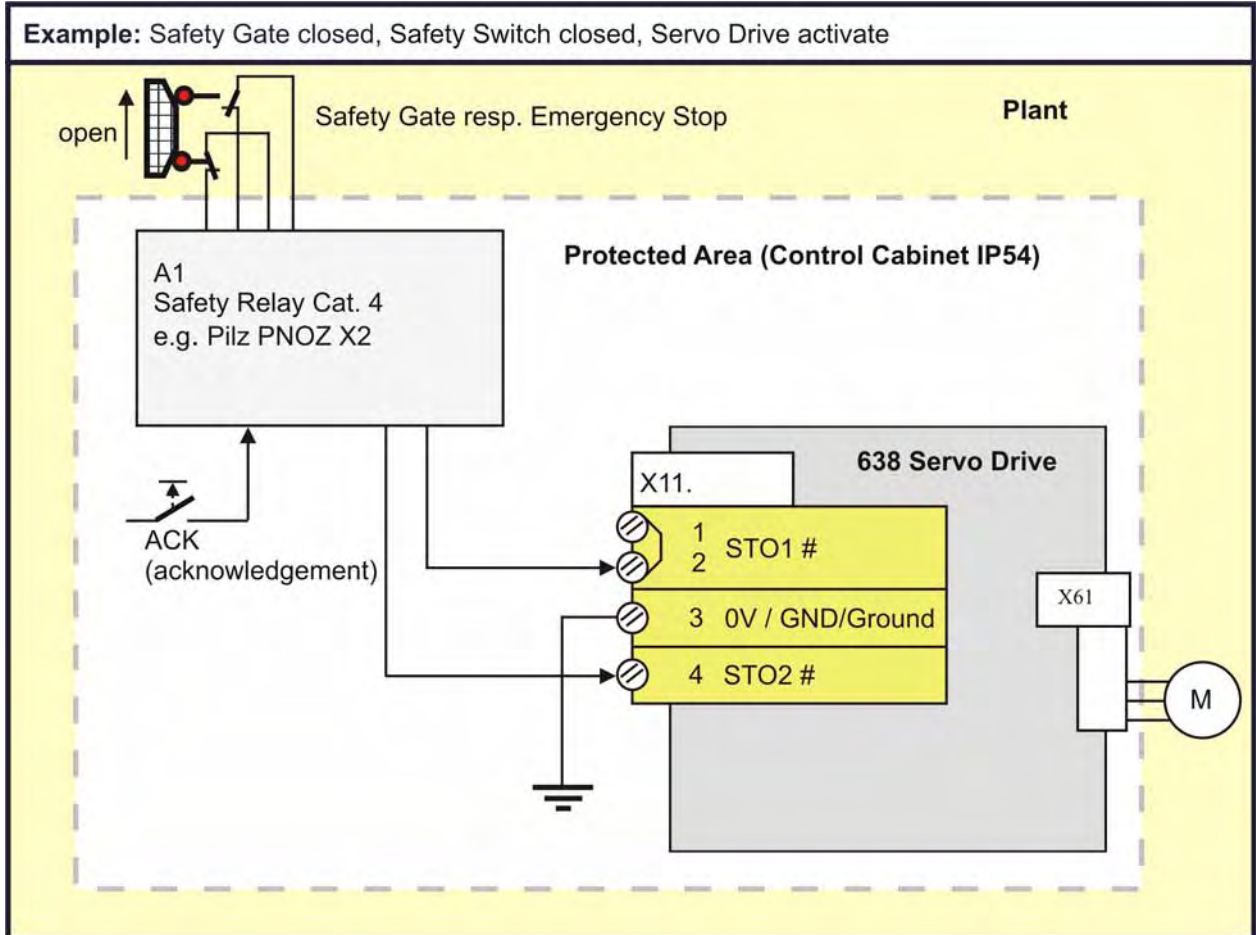

**Important**

The category 4 and PL e protection level can only be achieved with an active STO-Power-On-Test.

**Note**

The acknowledgement is only necessary, when after the cancellation of the STO function by the automatic start-up, a potential danger for the people in the area or the equipment exists.

## 9 Safe Torque Off (STO)

### Application Example 2

Function/Action	Response/Reaction	Protection Level		Stop Cat. According to EN60204
		EN 954-1	ISO 13849-1	
Safety door monitoring or emergency shut-down with protection monitoring switch and time delay	Active braking occurs when the safety door is opened, the emergency shut-down switch is activated or tripping of the ,STO' occurs due to time delay.	Cat. 4	PL e	1

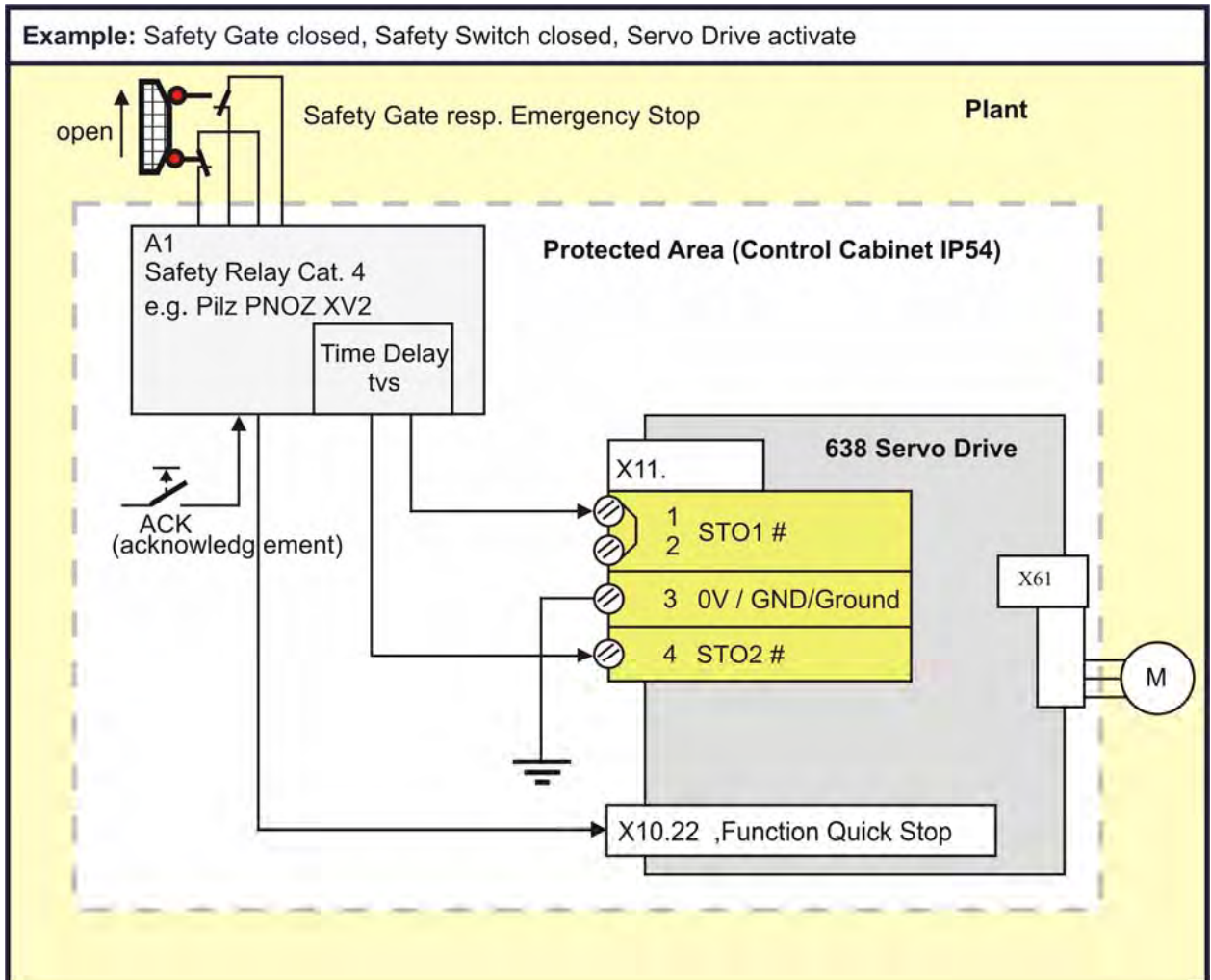

#### Important

The category 4 and PL e protection level can only be achieved with an active STO-Power-On-Test.

#### Explanation

The protection switch unit A1 must be set up with a fail-safe time delay as determined and required by the specific category relating to the application environment.

The 638 Servo Drive must be properly configured for the operating environment (See: Chapter [Configuration and Parameter Settings](#)).

#### Note

The acknowledgement is only necessary, when after the cancellation of the STO function by the automatic start-up, a potential danger for the people in the area or the equipment exists.

● **Application Example 3**

Function/Action	Response/Reaction	Protection Level EN 954-1	ISO 13849-1	Stop Cat. According to EN60204
Safety door monitoring or emergency shut-down WITHOUT protection monitoring switch	The ,STO' is tripped when the safety door is opened or emergency shut-down switch is activated.	Cat. 3	PL d	0

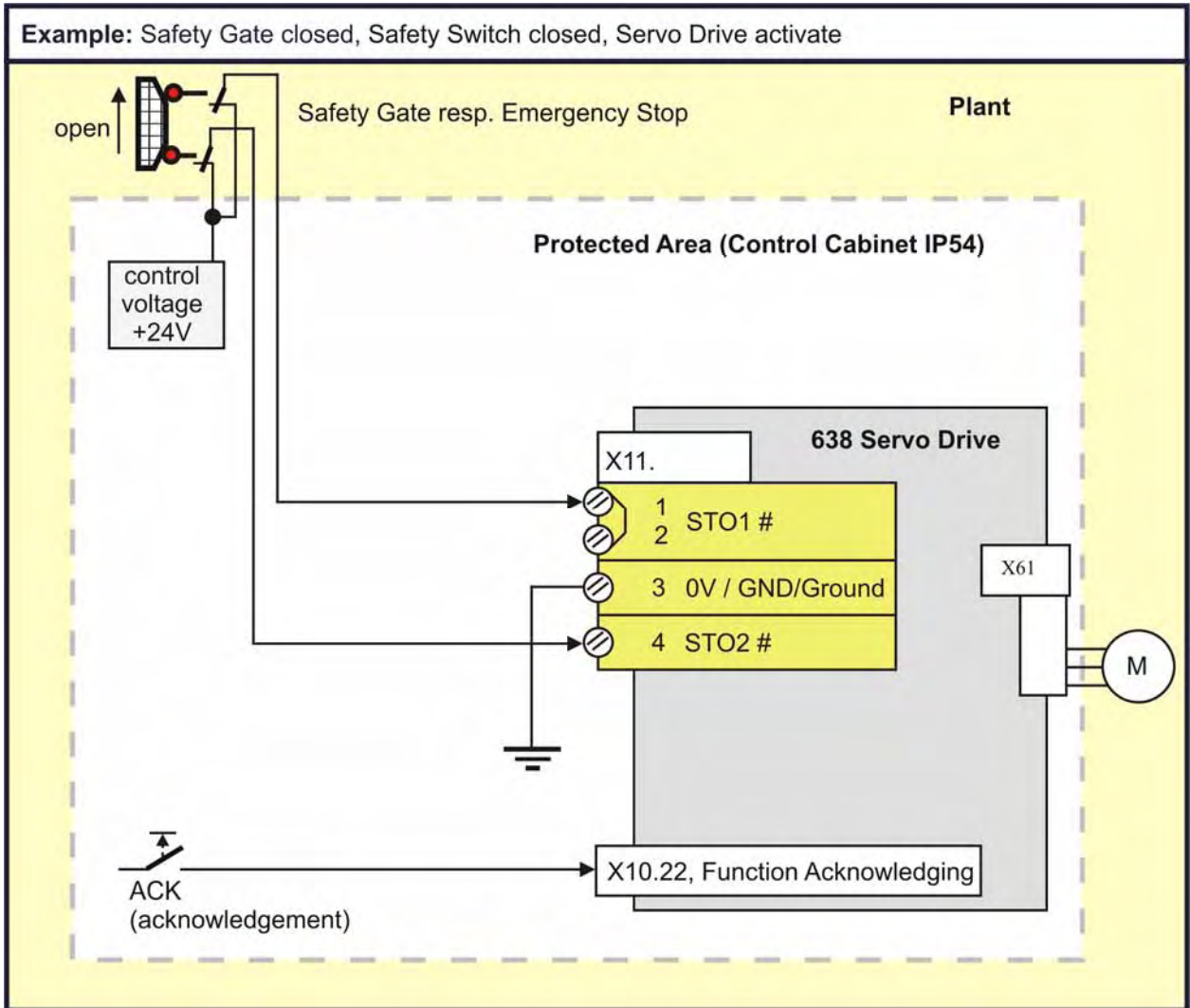

**Explanation**

The signals for STO1# and STO2# are delivered utilizing two separate channels. The wiring layout plan must allow for the physical separation of the wiring channels or incorporate adequate insulation protection and separation.

**Note**

The acknowledgement is only permissible with category B. The acknowledgement is **not** permissible for use if the dangerous area is [accessible](#). In this case, employment of an external acknowledgement unit is necessary.

The acknowledgement is only necessary, when after the cancellation of the STO function by the automatic start-up, a potential danger for the people in the area or the equipment exists.

## 9 Safe Torque Off (STO)

### Application Example 4

Function/Action	Response/Reaction	Protection Level EN 954-1	ISO 13849-1	Stop Cat. According to EN60204
Safety door monitoring or emergency shut-down with protection monitoring switch and time delay of several drives	Active braking occurs when the safety door is opened, the emergency shut-down switch is activated or tripping of the ,STO' occurs due to time delay.	Cat. 4	PL e	1

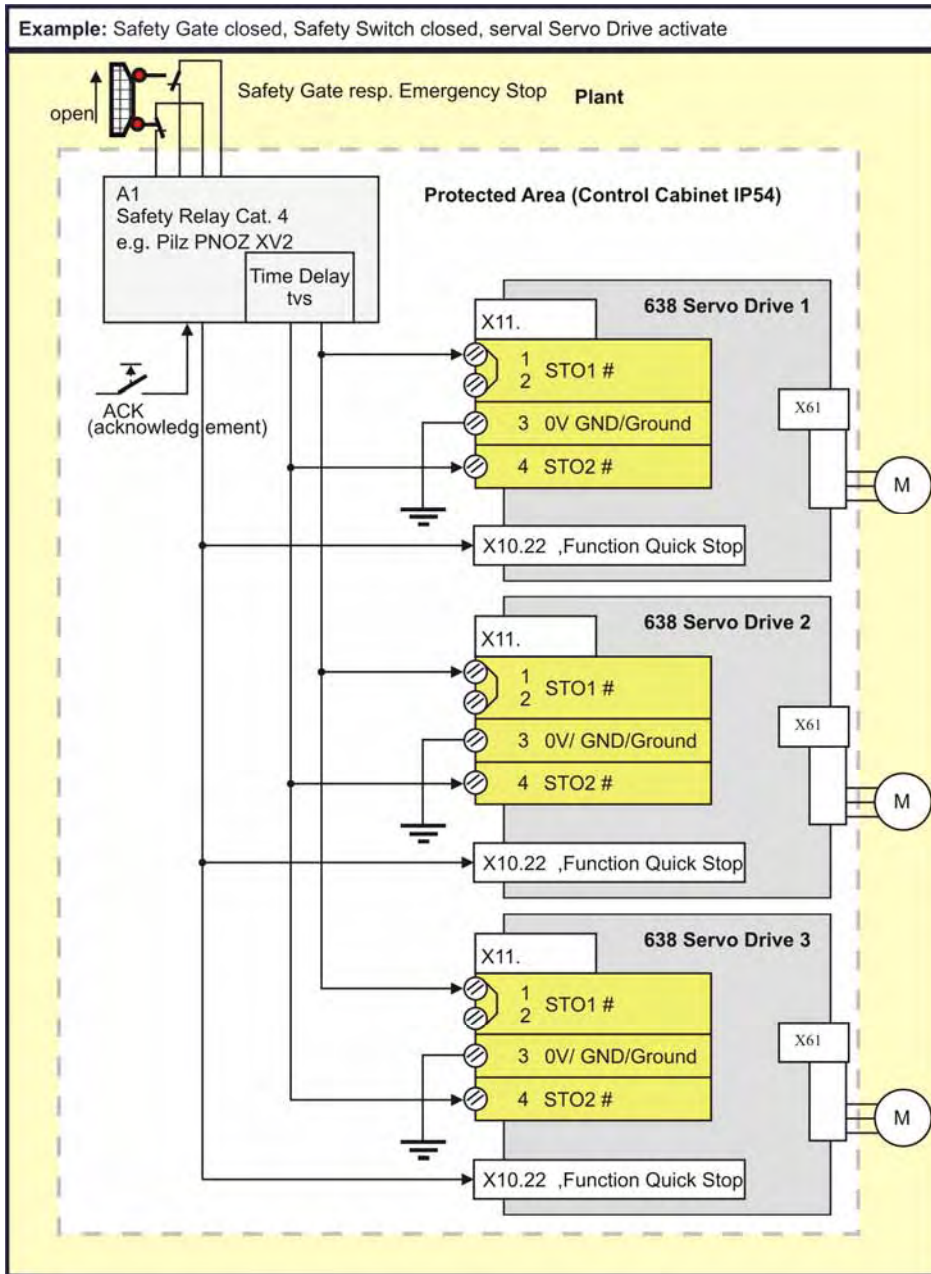

#### Important

The category 4 and PL e protection level can only be achieved with an active STO-Power-On-Test.

#### Explanation

The protection switch unit A1 must be set up with a fail-safe time delay as determined and required by the specific category relating to the application environment.

The 638 Servo Drive must be properly configured for the operating environment

(See: Chapter [Configuration and Parameter Settings](#)). Only 16 drives could plug together in a group.

#### Note

The acknowledgement is only necessary, when after the cancellation of the STO function by the automatic start-up, a potential danger for the people in the area or the equipment exists.



9.5 STO Function Test

The STO function must be tested when:

- The system is set-up for the first time. See: [Commissioning](#)
- Any component of the system is replaced.
- Any activity involving the wiring takes place.
- After all modifications to the drive system. (For example: parameter modifications, software updates, etc.)
- Established maintenance schedules dictate or after the machine has been inactive for a long period of time.

The STO functions test must be carried out by qualified personnel, with consideration for the required safety provisions. Depending upon the system configuration and application, additional or other tests may be required.

Test Steps:













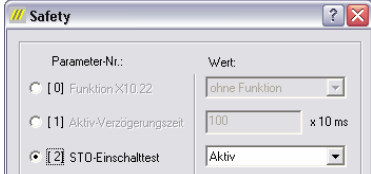

[STO Test Step 1](#)

[STO Test Step 2](#)









[STO Test Step 3](#)









[STO Test Step 4](#)



[STO Test Step 5](#)

STO-TEST Step 	1 	Action / Function	Anticipated Result	Remark, Cause of Fault Condition
STO-TEST 1.1	<b>Prerequisite:</b> 1.1.1 <b>Safety Parameter: STO "Power On" Test is Active</b> 1.1.2 <b>Supply Voltage US = 0 V (off)</b>			
STO-TEST 1.2	24V DC Voltage to Terminal X11.1 and Terminal X11.4			If the safety parameter, "Start-up Test" – is deactivated, then the drive will be activated immediately after the switch is turned on! 
STO-TEST 1.3	Supply Voltage US = 24 V to the System			Test steps 2-4 can then be performed anyway.
STO-TEST Step 	2 	Action / Function	Anticipated Result	Remark, Cause of Fault Condition
STO-TEST 2.1	<b>Terminal X11.1 Test:</b> Switch off 24 V DC Voltage at terminal X11.1		flash 	
STO-TEST 2.2	Wait approx. 20 seconds	Check 7-Segment-Display	flash 	
STO-TEST 2.3	After approx. 20 seconds	Check 7-Segment-Display	Software-STO control mechanism successful 	
STO-TEST 2.4	Switch on 24 V DC Voltage at Terminal X11.1		Hardware- STO control mechanism successful 	

## 9 Safe Torque Off (STO)

STO-TEST Step 	3 	Action / Function		Anticipated Result	Remark, Cause of Fault Condition
STO-TEST 3.1	<b>Terminal X11.4 Test:</b> Rebuild <a href="#">STO Test Step 1</a>	Switch the 24V Supply Voltage Off→On			
STO-TEST 3.2	Switch off 24 V DC Voltage at Terminal X11.4			 flash	
STO-TEST 3.3	Wait approx. 20 seconds	Check 7-Segment-Display		 flash	
STO-TEST 3.4	After approx. 20 seconds	Check 7-Segment-Display	Software-STO control mechanism successful		
STO-TEST 3.5	Switch on 24 V DC Voltage at Terminal X11.4		Hardware- STO control mechanism successful		

STO-TEST Step 	4 	Action / Function		Anticipated Result	Remark, Cause of Fault Condition
STO-TEST 4.1	<b>Terminal X11.1 and Terminal X11.4 Test:</b> Rebuild <a href="#">STO Test Step 1</a>	Switch the 24V Supply Voltage Off→On			
STO-TEST 4.2	Switch Off 24 V DC Voltage at Terminal X11.1 and Terminal X11.4				
STO-TEST 4.3	Wait approx. 20 seconds	Check 7-Segment-Display			
STO-TEST 4.4	After approx. 20 seconds Switch on 24 V DC Voltage at Terminal X11.1 and Terminal X11.4		If the drive has no fault and no other switch off condition is set - then the drive is activated.		

STO-TEST Step 	5 	Action / Function			
STO-TEST 5	Once all of the relevant safety test steps have been accomplished, the actions taken must be documented. The protocol form can be found in the Appendix <a href="#">STO - Safety - Parameter - Report - Proposal</a> .				



## 9.6 Signal Inputs Technical Data - Terminal Connection X11

General	The technical data provided in the section <a href="#">General Technical Data</a> is valid, with the exception of the data listed below.
Nominal Voltage from the Inputs	24 V DC
Required Insulation from the Control Voltage 24V	protective extra-low voltage (PELV)
STO – Control Voltage Protection	1A
Number of Inputs Signal Inputs via Opto-Coupler	2 L = 0...7 V DC or open H = 15...30 V DC $I_{in}$ at 24VDC: 8 mA
STO1#	L = STO activate H = STO deactivate
STO2#	L = STO activate H = STO deactivate
Break Time at Unequal Input Conditions Function see <a href="#">Status Diagram</a>	approx. 20 seconds

# 10 Diagnosis and Trouble-Shooting

## 10.1 7-Segment-Display

Many sources of faults can be narrowed down with the diagnosis display.

Display (Code) <sup>4</sup>	Explanation Comment	Output		Servo drive			
		Ready	Warning <sup>2)</sup>	631	635/637	637+	637f/638
	00h no display	off	off	<input checked="" type="checkbox"/>	<input checked="" type="checkbox"/>	<input checked="" type="checkbox"/>	<input checked="" type="checkbox"/>
	any control voltage? external fuses ok?						
	03h system ready for operate	on	off	<input checked="" type="checkbox"/>	<input checked="" type="checkbox"/>	<input checked="" type="checkbox"/>	<input checked="" type="checkbox"/>
	drive ready, not active						
	01h drive active and ready for operate!	on	off	<input checked="" type="checkbox"/>	<input checked="" type="checkbox"/>	<input checked="" type="checkbox"/>	<input checked="" type="checkbox"/>
	DC link voltage within the limits, power stage active, fault-free						
	12h internal STOP with serial deactivating	off	off	<input checked="" type="checkbox"/>	<input checked="" type="checkbox"/>	<input checked="" type="checkbox"/>	<input checked="" type="checkbox"/>
	activate drive via serial interface						
	82h drive of serial interface (bus interface) deactivated !	off	off	<input checked="" type="checkbox"/>	<input checked="" type="checkbox"/>	<input checked="" type="checkbox"/>	<input checked="" type="checkbox"/>
	only if bus interface is integrated						
	90h deactivated with delay time for the brake	on	off	<input checked="" type="checkbox"/>	<input checked="" type="checkbox"/>	<input checked="" type="checkbox"/>	<input checked="" type="checkbox"/>
	deactivated via input.						
	deactivated via serial command.						
	92h Active input is activated with switching on 24 V control voltage	off	off	<input checked="" type="checkbox"/>	<input checked="" type="checkbox"/>	<input checked="" type="checkbox"/>	<input checked="" type="checkbox"/>
	switch enable X10.xx switch on 0 V and after that 24 V						
	46h Under voltage of control voltage	off	off	<input type="checkbox"/>	<input checked="" type="checkbox"/>	<input checked="" type="checkbox"/>	<input checked="" type="checkbox"/>
	Power supply switched on? Power supply o.k. ? internal fuse o.k.? control voltage < 17 V						
	60h Under voltage in DC-bus < Ua low threshold	off	off	<input checked="" type="checkbox"/>	<input checked="" type="checkbox"/>	<input checked="" type="checkbox"/>	<input checked="" type="checkbox"/>
	check power supply (power supply unit, wiring, fuse), check under voltage parameter						
	DAh feedback system error (e.g. resolver)	off	off	<input checked="" type="checkbox"/>	<input checked="" type="checkbox"/>	<input checked="" type="checkbox"/>	<input checked="" type="checkbox"/>
	wiring to encoder system ok? encoder system supply ok?						
	DAh „flashing“ Resolver - Feedbacksystem Error	off	off	<input type="checkbox"/>	<input type="checkbox"/>	<input type="checkbox"/>	<input checked="" type="checkbox"/>
	00h wiring to resolver system ok?						
	DAh „flashing“ HIPERFACE Feedbacksystem Error	off	off	<input type="checkbox"/>	<input type="checkbox"/>	<input type="checkbox"/>	<input checked="" type="checkbox"/>
	6Eh wiring to HIPERFACE system ok? Check serial HIPERFACE channel						



Display (Code) <sup>4</sup>	Explanation Comment	Output		Servo drive				
		Ready	Warning <sup>2)</sup>	631	635/637	637+	637f/638	
	F2h	I <sup>2</sup> t- overload of the drive	1)	1)	<input checked="" type="checkbox"/>	<input checked="" type="checkbox"/>	<input checked="" type="checkbox"/>	<input checked="" type="checkbox"/>
		does the control loop oscillate? P-amplification too high mechanics stiff? requirements too high? is warning /8/ evaluated?						
	66h	I <sup>2</sup> t overload of the motor	1)	1)	<input checked="" type="checkbox"/>	<input checked="" type="checkbox"/>	<input checked="" type="checkbox"/>	<input checked="" type="checkbox"/>
		does the control loop oscillate? P-amplification too high mechanics stiff? requirements too high? is warning /8/ evaluated?						
	B6h	over temperature of the output stage (> 90°C)	1)	1)	<input checked="" type="checkbox"/>	<input checked="" type="checkbox"/>	<input checked="" type="checkbox"/>	<input checked="" type="checkbox"/>
		adequate cooling of the regulator? ambient temperature too high?						
	3Eh	over voltage on DC bus	1)	1)	<input checked="" type="checkbox"/>	<input checked="" type="checkbox"/>	<input checked="" type="checkbox"/>	<input checked="" type="checkbox"/>
		ballast module ok? adequate ballast module?						
	E0h	chassis shorting and short circuit due to hardware	off	off	<input checked="" type="checkbox"/>	<input checked="" type="checkbox"/>	<input checked="" type="checkbox"/>	<input checked="" type="checkbox"/>
		motor cabling ok? digital-loops setup ok? short circuit to chassis in the motor? braking resistor: ohm- value too low? try to start fresh! send in for repair						
	FEH	WARNING! Overload of the regulator I <sup>2</sup> t or motor I <sup>2</sup> t or temp.-output stage too high. If no reaction within approx. 3sec.it switches off with signals /3/, /4/ or /5/. Signal /8/ clears when there is no more danger or it is switched off	on	1)	<input checked="" type="checkbox"/>	<input checked="" type="checkbox"/>	<input checked="" type="checkbox"/>	<input checked="" type="checkbox"/>
		mechanics stiff? defective bearings; cold grease? reduce requirements and creep to next possible STOP						
	F6h	over temperature motor(NTC/PTC)	off	1)	<input checked="" type="checkbox"/>	<input checked="" type="checkbox"/>	<input checked="" type="checkbox"/>	<input checked="" type="checkbox"/>
		check overload of the motor / cooling etc.						
	2Eh	motor temperature too high	on	1)	<input checked="" type="checkbox"/>	<input checked="" type="checkbox"/>	<input checked="" type="checkbox"/>	<input checked="" type="checkbox"/>
		check overload of the motor / cooling etc.						
	80h	ballast active	on	off	<input checked="" type="checkbox"/>	<input checked="" type="checkbox"/>	<input checked="" type="checkbox"/>	<input checked="" type="checkbox"/>
		Brake energy is removed						
	38h	Warning: I <sup>2</sup> t ballast too high	on	on	<input checked="" type="checkbox"/>	<input checked="" type="checkbox"/>	<input checked="" type="checkbox"/>	<input checked="" type="checkbox"/>
		ballast resistance usage >90%						
	7Ch	switch off ballast	off	off	<input checked="" type="checkbox"/>	<input checked="" type="checkbox"/>	<input checked="" type="checkbox"/>	<input checked="" type="checkbox"/>
		ballast resistance overloaded						
	6Ch	X 300 – Module not inserted or wrong inserted or defect	off	off	<input type="checkbox"/>	<input type="checkbox"/>	<input checked="" type="checkbox"/>	<input checked="" type="checkbox"/>
		X 300 testing						

# 10 Diagnosis and Trouble-Shooting

Display (Code) <sup>4</sup>	Explanation Comment	Output		Servo drive			
		Ready	Warning <sup>2)</sup>	631	635/637	637+	637f/638
	6Eh X 300 – setting wrong	off	off	<input type="checkbox"/>	<input type="checkbox"/>	<input checked="" type="checkbox"/>	<input checked="" type="checkbox"/>
	X 30 / X40 Counter-Configuration test in the EASYRIDER® Windows – Software						
	1Ch tracking window exceeded 3)	on		<input checked="" type="checkbox"/>	<input checked="" type="checkbox"/>	<input checked="" type="checkbox"/>	<input checked="" type="checkbox"/>
	only in operation mode position control, will be deleted with the next run-command						
	1Eh tracking error with switch off	on	off	<input checked="" type="checkbox"/>	<input checked="" type="checkbox"/>	<input checked="" type="checkbox"/>	<input checked="" type="checkbox"/>
	only in operation mode "position control"						
	20h limit switch + 3)	on	off	<input checked="" type="checkbox"/>	<input checked="" type="checkbox"/>	<input checked="" type="checkbox"/>	<input checked="" type="checkbox"/>
	limit switch + X10.xx on 0 Volt, from Firmware 6.16			X10.8	X10.14	X10.14	X10.14
	08h limit switch - 3)	on	off	<input checked="" type="checkbox"/>	<input checked="" type="checkbox"/>	<input checked="" type="checkbox"/>	<input checked="" type="checkbox"/>
	limit switch - X10.xx on 0 Volt, from Firmware 6.16 3)			X10.9	X10.15	X10.15	X10.15
	9Eh limit switch + / limit switch -	on	off	<input checked="" type="checkbox"/>	<input checked="" type="checkbox"/>	<input checked="" type="checkbox"/>	<input checked="" type="checkbox"/>
	both limit switch X10.xx on 0 Volt, from Firmware 6.16			X10.8 X10.9	X10.14 X10.15	X10.14 X10.15	X10.14 X10.15
	76h memory-checksum-error	off	off	<input checked="" type="checkbox"/>	<input checked="" type="checkbox"/>	<input checked="" type="checkbox"/>	<input checked="" type="checkbox"/>
	try new start, store the value again						
	76h Different Drive type on X300-xM Module	aus	aus	<input type="checkbox"/>	<input type="checkbox"/>	<input type="checkbox"/>	<input checked="" type="checkbox"/> 638 with X300 xM-Module only
	62h DC Bus Unterspannung < 100 V			<input checked="" type="checkbox"/>	<input type="checkbox"/>	<input type="checkbox"/>	<input type="checkbox"/>
	-						
	4Eh 1: internal software error, Watchdog	off	off	<input checked="" type="checkbox"/>	<input checked="" type="checkbox"/>	<input checked="" type="checkbox"/>	<input checked="" type="checkbox"/>
	2: blinking: BIAS software error			<input type="checkbox"/>	<input type="checkbox"/>	<input type="checkbox"/>	<input checked="" type="checkbox"/>
	1: Firmware version check						
	2: Bias program error fix						
	EEh starting lockout RP SBT with 637f starting lockout STO1 and STO2 with 638	on	off	<input type="checkbox"/>	<input type="checkbox"/>	<input type="checkbox"/>	<input checked="" type="checkbox"/>
	Terminal X290. 3/4 check with 637f Terminal X11. 1/4 check with 638						
	24h STO1 und STO2 Signale Difference>20 Seconds	off	off	<input type="checkbox"/>	<input type="checkbox"/>	<input type="checkbox"/>	<input checked="" type="checkbox"/>
	Switch Off /On Control Voltage						638 only

Display (Code) <sup>4</sup>	Explanation Comment	Output		Servo drive			
		Ready	Warning <sup>2)</sup>	631	635/637	637+	637f/638
	26h X10.22 Quickstop Ramp active	on	off	<input type="checkbox"/>	<input type="checkbox"/>	<input type="checkbox"/>	<input checked="" type="checkbox"/> 638 only
	42h X10.22 low high slope missing	on	off	<input type="checkbox"/>	<input type="checkbox"/>	<input type="checkbox"/>	<input checked="" type="checkbox"/> 638 only
	2Ah Max. speed overload	off	off	<input type="checkbox"/>	<input type="checkbox"/>	<input type="checkbox"/>	<input checked="" type="checkbox"/>
	check speed limits resp. setpoint speed						
	4Ah CAN - Open 402 Sync Message error in Interpolated positioning mode	on	off	<input checked="" type="checkbox"/> 6.19c	<input type="checkbox"/>	<input type="checkbox"/>	<input checked="" type="checkbox"/> 8.19d
	-						
	9Ch SSI – Encoder Error	on	off	<input type="checkbox"/>	<input type="checkbox"/>	<input type="checkbox"/>	<input checked="" type="checkbox"/> 8.21
	-						
	9Ch CAN1-BUS Error Flashing display Noise on bus or lane missing!	on	off	<input type="checkbox"/>	<input type="checkbox"/>	<input type="checkbox"/>	<input checked="" type="checkbox"/> 8.33
	-						
	1Ah CAN2 Bus Error			<input type="checkbox"/>	<input type="checkbox"/>	<input type="checkbox"/>	<input checked="" type="checkbox"/> 8.36
	Flashing Display: Control loop synchronization between drives						
	CEh Profibus-Module Error	on	off	<input type="checkbox"/>	<input type="checkbox"/>	<input type="checkbox"/>	<input checked="" type="checkbox"/> 8.31
	ECh Warning:setpoint current maximum limit reached and no actual current measurement (check motor connection)	on	off	<input type="checkbox"/>	<input type="checkbox"/>	<input type="checkbox"/>	<input checked="" type="checkbox"/> 8.34
	30h 638 Active Delay time runs	on	off	<input type="checkbox"/>	<input type="checkbox"/>	<input type="checkbox"/>	<input checked="" type="checkbox"/> 638 only
	8Eh 638 SAFETY- Parameter Ram Error	off	off	<input type="checkbox"/>	<input type="checkbox"/>	<input type="checkbox"/>	<input checked="" type="checkbox"/> 638 only
	C4h 638 X300 xM Module, Memory Error Firmware, Altercode and Parameters missing	off	off	<input type="checkbox"/>	<input type="checkbox"/>	<input type="checkbox"/>	<input checked="" type="checkbox"/> 638 only with X300 xM-Module
	44h 638 X300 xM Module, Memory Error Altercode and Parameter- and BIAS-Data missing	off	off	<input type="checkbox"/>	<input type="checkbox"/>	<input type="checkbox"/>	

## 10 Diagnosis and Trouble-Shooting

Display		Explanation Comment	Output		Servo drive			
(Code) <sup>4</sup>			Ready	Warning <sup>2)</sup>	631	635/637	637+	637f/638
	04h	638 X300 xM Module, Memory Error Alteracode missing	off	off	<input type="checkbox"/>	<input type="checkbox"/>	<input type="checkbox"/>	
	40h	638 X300 xM Module, Memory Error Parameter- and BIAS-Data missing	off	off	<input type="checkbox"/>	<input type="checkbox"/>	<input type="checkbox"/>	

- 1) Reaction to these errors **chapter: “■ Function diagrams from inputs and outputs”**
- 2) With configuration corresponding **chapter : “■ Operating modes and pin functions”**
- 3) Operating mode “Position Control” only
- 4) The display code you can get with the serial command „internal diagnosis 2“ (0x26) in byte 16.

The error signals are shown as long as there is control voltage (Us), also when the power (DC-Bus) is switched off for safety reasons.



## 10.2 Reset of a Drive Trouble

A general precondition for correct execution of the Reset is the elimination of the error cause.

### Possible error signals

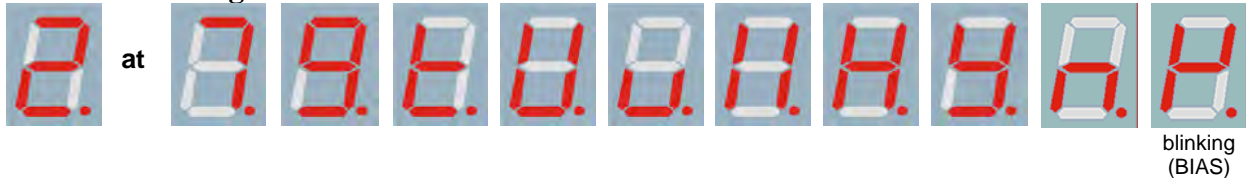

The error signals of the drive can be reset via:

1. **Control voltage OFF/ON,**
2. **the serial command "Drive Reset" 0x02**  
The host login must be occurred.  
The drive must be deactivated via the serial command "deactivate Drive" 0x00.
3. **the fieldbus-command " Drive Reset" 0x16 (22 decimal)**  
The host login must be occurred via the BUS command 0x01. The drive must be deactivated via the BUS command "deactivate Drive" 0x14.  
The fieldbus command "Drive Reset" with constant repetition of the fieldbus command 0x16 will be works-off only once.  
For further processing, it is necessary, meanwhile to send another control word (e.g. 0 status order).
4. **Viva 0 – 1 flank on input X10.11**  
Precondition:
  - The input X10.11 is with function 1 "Reset drive fault" configured (EASYRIDER® Windows – Software)
  - There is no host login.
  - The input Active, (X10.22) is inactive (0V)
  - The signal must be present min. 250 ms
5. **Viva 0 – 1 flank on input X120.1**  
Precondition:
  - The input X120.1 is with function 1 "Reset drive fault" configured (EASYRIDER® Windows – Software)
  - There is no host login.
  - The input Active, (X10.22) is inactive (0V) 1)
  - The signal must be present min. 250 ms

### Notice !!

After remove of the tracking error deactivation the warning message (tracking error) is active up to the next move command.

The **error signal** (releasing before ready) can be reset by deactivation the drive.

# 10 Diagnosis and Trouble-Shooting

## 10.3 Trouble-Shooting

The following list refers to faults which can occur during operation.

Display:



Error	Explanation and remedy	
no motor run despite current flow	motor mechanically blocked? motor brake released?	1)
motor runs unevenly	check setpoint wiring check grounding and shielding too high P-amplification in the speed controller reduce value (with EASYRIDER® setting/speed control) too small I-time in the speed controller? reduce value (with EASYRIDER® setting/speed control)	
no reaction of setpoint progression, despite torque in standstill	Limit switch functions effective (BIAS)	
no current flow; no torque despite activating the regulator correctly	motor cables interrupted? Is input "I extern" (X10.19) activated (config. menu) and not notched up? <b>limit switch - input</b> activated and not notched up?	
Interference symptoms with power frequency	Ground loops in setpoint or actual value wiring? Shieldings laid on both sides? Signal cables near high voltage cables?	
Motor takes up preferred positions after activation	Position encoder or motor cables with reversed poles? Resolver or Feedback- encoder incorrectly adjusted? Number of motor poles wrong matching? (config. menu)	1)
Motor runs up immediately after activation although there is no setpoint	Motor cables or feedback- cables reversed? Encoder incorrectly adjusted? (e.g. Resolver)	1)
Motor reaches in idling cycle very different speed when running to the right or to the left	Feedback-Encoder incorrectly adjusted (e.g. Resolver)	

1) Display



or



mostly short after activating; before warning



## 11.1 Compliance with Regulations, Limitations and Basic Conditions

European Directives	
EG Low-Voltage Guidelines 2006/95/EC	In accordance with EN61800-5-1 Safety requirements – Electrical, thermal and energy.
EG-EMC-Directive 2004/108/EC	EN 61 800-3, Emissions and immunity levels for Power drive systems.

UL - Approved / being prepared		
Underwriter Laboratory Standard	UL 508 C	Power Conversion Equipment
UL File-No.	E....	
Canadian Standards Association	C22.2 No.14	Industrial Control Equipment

Insulation Requirement		
Protection Class	EN 50 178	I
Overvoltage Category	IEC 60364-4-443:1999	III
Pollution Degree	EN 61800-2, 4.1.2.1	2

Environmental Conditions		
General Environmental	EN 61800-2	
Ambient Temperature Rating:		
Operations	IEC 60721-3-3	+ 5 bis +40 °C, 3K3
Storage	IEC 60721-3-3	-25 bis +55 °C, 1K4
Transport	IEC 60721-3-2	-25 bis +70 °C, 2K3
Allowable Humidity:		
Operations	IEC 60721-3-3	<= 85% non-condensing, 3K3
Storage	IEC 60721-3-3	<= 95%, 1K4
Transport	IEC 60721-3-2	<= 95% at +40 °C, 2K3
Vibration:	EN60068-2-6 Test FC	10Hz ≤ f ≤ 57Hz sinusoidal 0,075mm amplitude 57Hz ≤ f ≤ 150Hz sinusoidal 1g 10 sweep cycles per axis 1 Oktave / Minute
Air Pressure		86 kPa – 106 kPa
Protection	EN 60529	IP20
Altitude	Under <= 1000m above sea level with 100% power rating Over >1000m .. <= 2000m above sea level, decrease the power rating by 1% per 100m	
Method of Cooling	638B 03 / 05	Convention cooling
	All 638A, 638B 08 / 10 / 15 All 638C	Forced ventilation (internal fan)

# 11 Standards and Certifications

EMC - Requirement				
		638A	638B	638C
<b>EMC – Emission (Conducted)</b>	EN 61 800-3	max. Motor cable length		
	First Environment C1	20m <sup>1)</sup>	<sup>2)</sup>	
<b>EMC – Emission (Radiated)</b>	First Environment C2	40m	20m	
	Second Environment C3		20m	
	EN 61 800-3			
	First Environment C1			
	First Environment C2			
	Second Environment C3			
<b>EMC – Immunity Levels</b>	EN 61800-3 (include EN 50081-2 and EN 50082-2)	<sup>3)</sup> meet meet	<sup>3)</sup> meet meet	
<b>EMC – Emission (Conducted)</b>	EN 61 800-3 First Environment C1 First Environment C2 Second Environment C3	Minimum standards for the Second Environment are kept to.		

<sup>1)</sup> for max. 100m motor cable length, use the drive with Option A (less leakage current) and the external filter Type LNF RA \*230/12.

<sup>2)</sup> With external Filter of the Serie LNFB, is a group RFI suppression for max. 4 Device with a overall  
Motor cable length of 60m, possible.

<sup>3)</sup> For the operation in the first environment with unlimited availability is a cabinet damping of at least  
10 dB in the frequency range of 30-1000MHz necessary.

## 12.1 General Technical Data

- **Power Circuit**

Galvanic Separation from the Control Circuit	in acc. with EN 61800-5-1/ UL 508C
Specifications in accordance with	EN 61800-5-1 / UL 508C and cUL
Short Circuit and to Frame Test for	min. 2000 releases
Overvoltage Monitoring	max. 400V DC $\pm$ 5V DC max. 810V DC $\pm$ 10V DC (638B/C)
Undervoltage Monitoring	min. 15V DC; configurable
Overheating Switch Off at	95 ° C $\pm$ 5%
Clock Frequency Powerstage	638A: 9,5 kHz 638B/C: 4,75kHz / 9,5kHz
Frequency of Current Ripple	9,5 kHz / 19 kHz

- **Control Circuit**

Galvanic Separation from the Power Circuit	in acc. with EN 61800-5-1 / UL 508
Further Information:	See: " <a href="#">Insulation Concept</a> "

- **Signal Inputs and Outputs - Connection X10**

Additional Galvanic Separation from Power and Control Circuit	
Nominal Voltage of the In and Outputs	24 V DC
Number of Outputs Signal Outputs via OPTO Coupler	5 $U_{max} = 45V DC$ ; $I = 0..60 mA$ ; short circuit proof, resistive load
Signal Outputs via RELAY	$U_{max} = 45V DC$ ; $I = 1\mu A...1,2A$
Contact Protection with Inductive Load	internal varistor
Number of Inputs Signal Outputs via OPTO Coupler	8 $L = 0...7 V DC$ or open $H = 15...30 V DC$ $I_{in} 24VDC: 8 mA$
Shortest Time for a Signal to All Inputs - to Accept the Signal in an Application:	> 1 ms
Damping of the Transfer from Low to High (0-->24V):	fast input: 20 $\mu$ s (X10.4, X10.25)      default input: 200 $\mu$ s
Interrupt Response Time for Fast Input	10 $\mu$ s (X10.4, X10.25)
Damping of the Transfer from High to Low (24-->0V)	fast input: 250 $\mu$ s (X10.4, X10.25)      default input: 1000 $\mu$ s

- **Thermo-Control X30**

No galvanic Separation to the Control Circuit	
Measurement Voltage at 100 / 1640 / 9999 Ohm	0,15V / 1,7V / 3,8V
Measurement Range	100..9999Ohm, short-circuit proof (Thermoswitch evaluable)

## 12 Technical Data

- **Thermo-Control X62**

Galvanic Separation to the Control Circuit Galvanic Separation to the Power Circuit	Basic Isolated in acc. with EN 61800-5-1 Double Isolation in acc. with EN 61800-5-1
Measurement Voltage at 100 / 1640 / 6000 Ohm	0,15V / 1,7V / 3,2V
Measurement Range	100..6000Ohm, short-circuit proof (Thermoswitch evaluable)

- **Brake-Control X62**

Galvanic Separation to the Control Circuit / - Power Circuit	Double Isolation in acc. with EN 61800-5-1
Nominal Voltage Supply	24V DC
Max. Brake Current	2A
Contact Protection for inductive Load	Internal Varistor (BR+ <-> BR-)

- **Signal Inputs and Outputs - Connection X120B resp. 120C**

Additional Galvanic Separation from Power and Control Circuit																
Nominal Voltage of the In and Outputs	24 V DC +20% / -10%															
Number of Outputs Signal Outputs via OPTO Coupler	4 resistive load I <sub>max.</sub> = 2A inductive load max. 1Henry <table border="1"> <thead> <tr> <th>I<sub>out</sub></th> <th>Inductance</th> <th>Max. Switching Frequency</th> </tr> </thead> <tbody> <tr> <td>1A</td> <td>1H</td> <td>1Hz</td> </tr> <tr> <td>1A</td> <td>0,1H</td> <td>10Hz</td> </tr> <tr> <td>0,33A</td> <td>1H</td> <td>10Hz</td> </tr> <tr> <td>0,2A</td> <td>0,5H</td> <td>50Hz</td> </tr> </tbody> </table> short-circuit current limited by (5A) over-heating protection, active overvoltage clamping (50V); keyed	I <sub>out</sub>	Inductance	Max. Switching Frequency	1A	1H	1Hz	1A	0,1H	10Hz	0,33A	1H	10Hz	0,2A	0,5H	50Hz
I <sub>out</sub>	Inductance	Max. Switching Frequency														
1A	1H	1Hz														
1A	0,1H	10Hz														
0,33A	1H	10Hz														
0,2A	0,5H	50Hz														
Number of Inputs Signal Outputs via OPTO Coupler	4 L = 0...7 V DC or open H = 15...30 V DC I <sub>in</sub> at 24VDC: 8 mA															
Shortest Time for a Signal to All Inputs to Accept the Signal in an Application:	> 1 ms															
Damping of the Transfer from Low to High (0-->24V):	default input: 200µs															
Damping of the Transfer from High to Low (24-->0V)	default input: 1000µs															



- **Digital Control**

<b>Current Control</b>	
Loop-Cycle-Time	105 $\mu$ s
Settings	according to factory specifications or motor data
Current Limits - Adjustment by:	speed control -menu Analog Input 0..10V = 0..100%; can be standardized, 10Bit

<b>Speed Control</b>	
Loop-Cycle-Time	105 $\mu$ s
Settings	speed control menu
Differential Setpoint Input Analog Resolution (including sign)	$U_{Soll} = 10$ V, can be normed; $R_i = 10k$ 14 bit
Digital Setpoint Input	via interfaces

<b>Position Control</b>	
Loop-Cycle-Time	105 $\mu$ s

- **Digital Communication**

RS232 - Service Interface	COM1 19200 baud, 8 data bits, 1 start bit, 1 stop bit, parity: even
<u>Optional</u> RS232 / RS422 / RS 485 on SUB D – Socket	COM2
CAN1, Profibus DP, SUCOnet K on SUB D – Socket Interbus S on SUB D – Socket (OUT)	
Interbus S (Remote IN) CAN2	additional on SUB D – socket

- **Resolver Evaluation / Transmitter Principles**

<u>General:</u> The specified data refers to the combination of the standard resolver interface with Function Module - X300_RD2; operated with the SSD Drives Resolver R 21-T05, R15-T05	
Carrier Frequency	$f_t = 4,75$ kHz
Ripple of the Actual Speed Value Signal	2% <sup>1)</sup>
Max. Position Resolution for One Revolution	65536 / 16 bit
Absolute Position Accuracy	+/- 0,7 ° <sup>1)</sup>
Relative Position Accuracy	+/- 0,08 ° <sup>1)</sup>

<sup>1)</sup> Data was checked – actual data results: Quality improved

## 12 Technical Data

---

- **Controller System**

System Start-Up Time after Switching On the Control Voltage	max. 6 seconds
Data Memory / Organization	Flash Eprom 256 KB RAM 64 KB; EEPROM 96 kByte

- **Mechanical Data**

Dimensions	see " <a href="#">■ Dimensions</a> "			
	638A	638B03 /05	638B08 /10/15	638C
Weight	1,6 Kg	2,7Kg	4,4Kg	

## 12.2 Technical Unit Data

## • 638A

Servo Drive			638A01..	638A02..	638A04..	638A06..
<b>Input</b>						
Supply Voltage 50..60 Hz (grounded at the centre point TN networks)	min.	[V]	14			
	Un	[V]	230			
	max.	tolerance	+10%			
Phases	<sup>1)</sup>		1 or 3			
Supply System			"■ Fuse, Contactors, Filter"			
Inrush Current Limitation	type		Softstart : capacitor - pre-charging over 390Ω			
Control Voltage	<sup>2)</sup>	Us	[V]	21,5 ... 24 ... 29		
Control Current Incl. Fan Permanent: Inrush peak:	Is DC	[A] [A/ms]	nominal 0,4 maximum 0,8 nominal 3 maximum 6/0,8; 2,5/25			
<b>Output</b>						
Sine Voltage with Un	Unr	[Veff]	220			
Derating of Unr			Depending on load or with 1-phase supply			
Rated Current Efficiency	Inr	[A]	1	2	4	6
Max. Current Efficiency Time for Imax	<sup>1)</sup>	Imaxr Sec	2	4	8	12
			5	5	5	5
Min. Motor Inductance (terminal / terminal)	Lph/ph	[mH]	10	6	3	2
<b>Brake Circuit</b>						
Operating Point DC	Ub	[V]	375			
Max. Power	Pbmax	[kW]	5,5			
Rated Power	Pbnenn	[W]	600			
Internal Brake Resistor	Rbint	[Ω]	170			
	Pd	[W]	20			
	Pmax	[W]	830			
Min. Ext. Brake Resistor	<sup>2)</sup>	Rbextmin	[Ω]	33 (use only our approved types)		
<b>General</b>						
Power Loss Fan, Electronics	max.	[W]	17			
Fan Control		[V]	2-stage control			
Power Loss Rating Class per A	nominal	[W/A]	7 (4,75kHz) / 9 (9,5kHz)			

<sup>1)</sup> Reference "• Output Power"

<sup>2)</sup> Recommended: Transformer power supply

## 12 Technical Data

- **Output Power 638A**

In the event of continuous operation in the full-load range, the limits as shown in the following diagram need to be respected. Typical servo applications are not affected by this restriction. (S3 operation: Start/Stop).

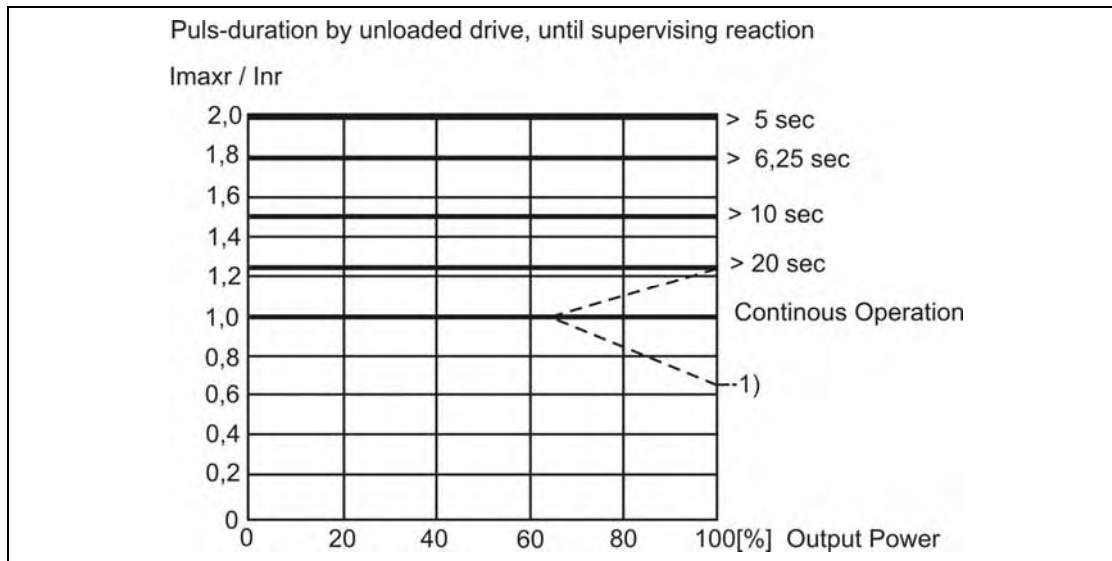

1) **At servo drive 638A/06.. :**

Load limitations decreased to 66% with 1phase incoming supply and continuous operation and speed. (S1)

- **Singlephase and Threephase supply**

Due to the line-ripple of the DC-Bus, the rate of usable output voltage is reduced as follows. This reduction affects the maximum attainable speed of the applied motor.

**Three-phase** supply: The unloaded output voltage will be reduced to approx. 90%, maximally 85 %

**Single-phase** supply: 50 – 60Hz: see following Diagram:

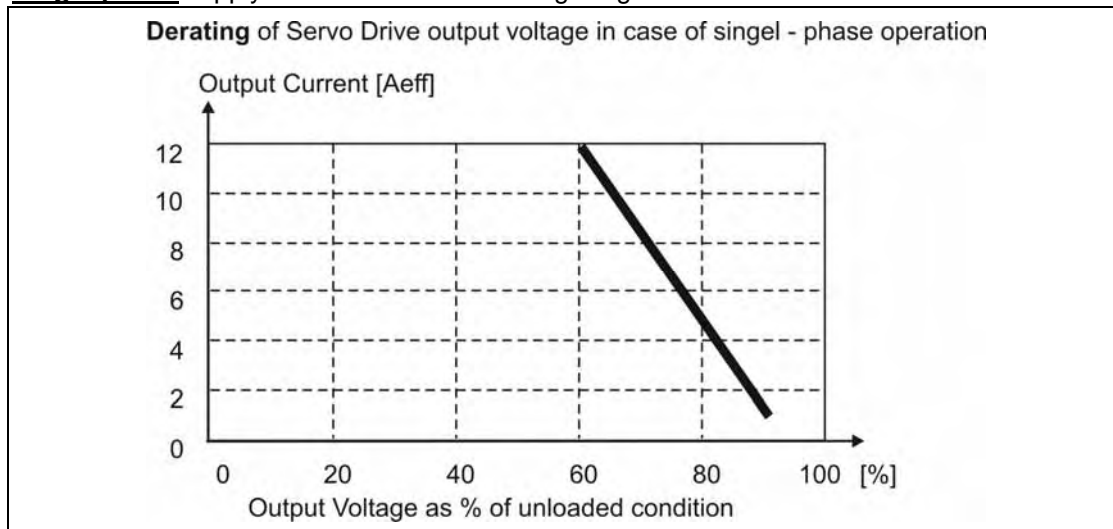

**Hint for Parameterization:**

To avoid the unexpected tripping of the under voltage threshold, the parameter setting should be left on the default values (EASYRIDER® Windows – Software).

Required motor-terminal-voltage for specified speed.

Approximation: (up to 3000RPM)

$$U_{KI} = 1,2 * (EMF * n / 1000) + I * (R_{ph} + R_L) [V]$$

$U_{KI}$  Required Motor Voltage [ $V_{RMS}$ ]

$EMF$  Back-EMF of Motor [ $V_{RMS}$ ] / 1000 RPM

$R_{ph}$  Resistance of Motor (between terminals) [ $\Omega$ ]

$R_L$  Line Resistance of Motor cable [ $\Omega$ ]

$I$  Motor Current [ $A_{RMS}$ ]

• **638B**

Servo-Drive	638B03.. 638B05.. 638B08.. 638B10. 638B15..							
<b>Input</b>								
Supply Voltage 50..60 Hz (grounded at centre point TN – networks)	min.	[V]	14					
	Un	[V]	400 / 480					
	max.	tolerance	-25% / +10%					
Phases	1)		3					
Supply System			"■ Power Mains Connection"					
Inrush Current Limitation	type		Softstart : capacitor – pre-charging over 340Ω					
Control Voltage	2)	Us	[V]	21,5 ... 24 ... 29				
Control Current nominal/maximal	3)	Is DC	[A]	0,6 / 1,0	0,7 / 1,1	0,8 / 1,2		
Control Current Inrush peak:		Is DC	[A/ms]	nominal 3 maximal 6/0,8; 2,5/25				
<b>Output</b>								
Sine-Voltage with Un	Unr	[Veff]	388 / 465					
Minderung von Unr			According to the load 1)					
Rated Current 400V AC/ 4,75kHz	Inr	[A]	2,5	5	7,5	10	15	
Rated Current 400V AC/ 9.5 kHz	Inr	[A]	2,5	5	7,5	10	10	
Rated Current 480V AC/ 4,75kHz	Inr	[A]	2,5	5	7,5	10	14,5	
Rated Current 480V AC/ 9,5kHz	Inr	[A]	2,5	4,5	6,8	9	9	
Max. Current efficiency Time for Imax	1)	Imaxr	[A]	5	10	15	20	30
		minimal	Sec	5	5	5	5	5
Min. Motor Inductance 4,75kHz 400 / 480V AC	Lph/ph	[mH]	8,9 / 10	4,5 / 5,0	3,3 / 3,0	2,2 / 2,5	1,5 / 1,7	
Min. Motor Inductance 9,5kHz 400 / 480V AC	Lph/ph	[mH]	4,4 / 5,0	2,2 / 2,5	1,5 / 1,7	1,1 / 1,2	0,7 / 0,8	
<b>Brake Circuit</b>								
Operating Point DC	Ub	[V]	675 / 760					
Max. Power 400/480V AC	Pbmax	[kW]	6,5 / 7,4		9,8 / 10,9	22 / 25,5		
Rated power	Pbnenn	[W]	1100					
Internal Brake Resistor 400V / 480V AC	Rbint	[Ω]	680		330			
	Pd	[W]	15		30			
	Pmax	[W]	670 / 849		1380 / 1750			
min. ext. Brake Resistor 400/480V	4)	Rbextmin	[Ω]	78 / 88	54 / 62	22/24	22/24	
<b>General</b>								
Power Loss Fan, Electronics	maximal	[W]	24		26,4	28,8		
Fan Control		[V]	24					
Power Loss Rating Class per A	nominal	[W]	11,5 (400V/4,75kHz), 15,8 (400V/9,5kHz), 11,8 (480V/4,75kHz), 16,8 (480V/9,5kHz)					

1) Reference "• Output Power 638B"

2) Recommended: Transformator power supply

## 12 Technical Data

- **Output Power 638B**

In the event of continuous operation in the full-load range, the limits as shown in the following diagram need to be respected. Typical servo applications are not affected by this restriction. (S3 operation:Start/Stop).

At mains voltage 400V no restriction of the output power on the devices withstands 5 / 7,5 / 10A.

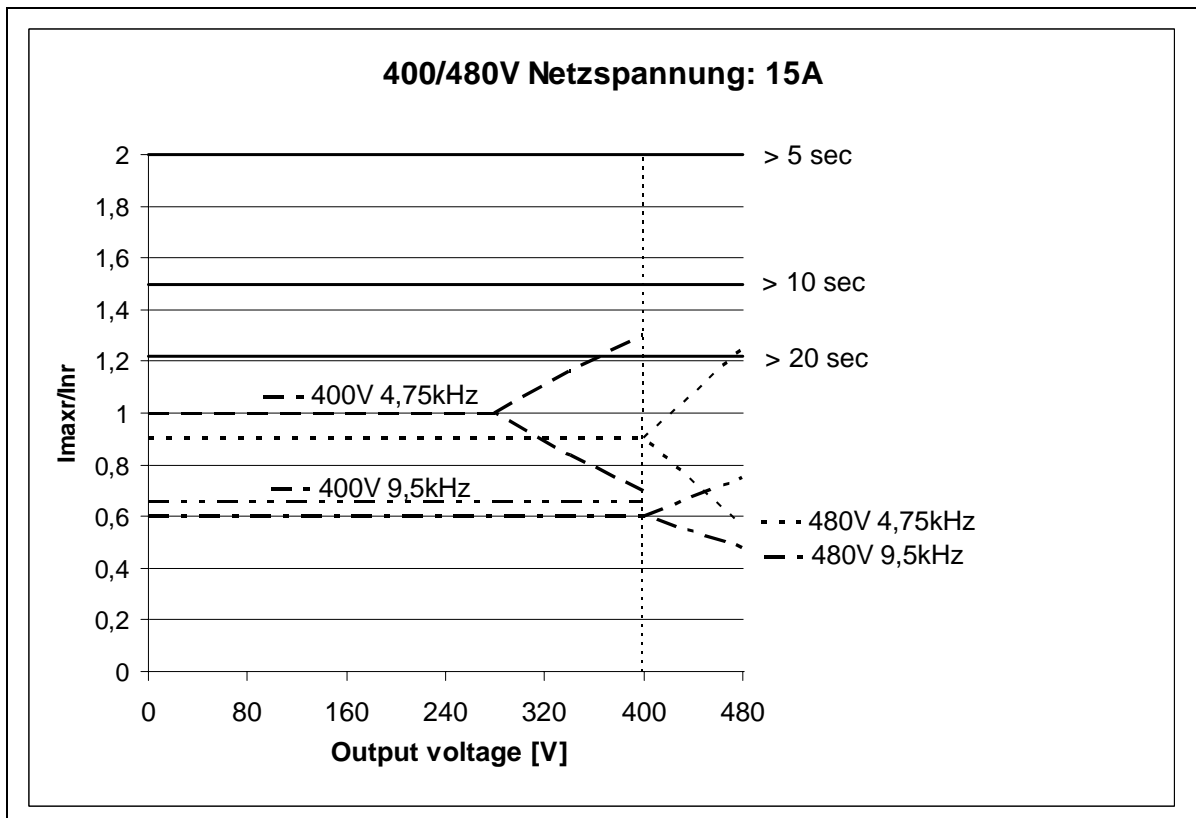
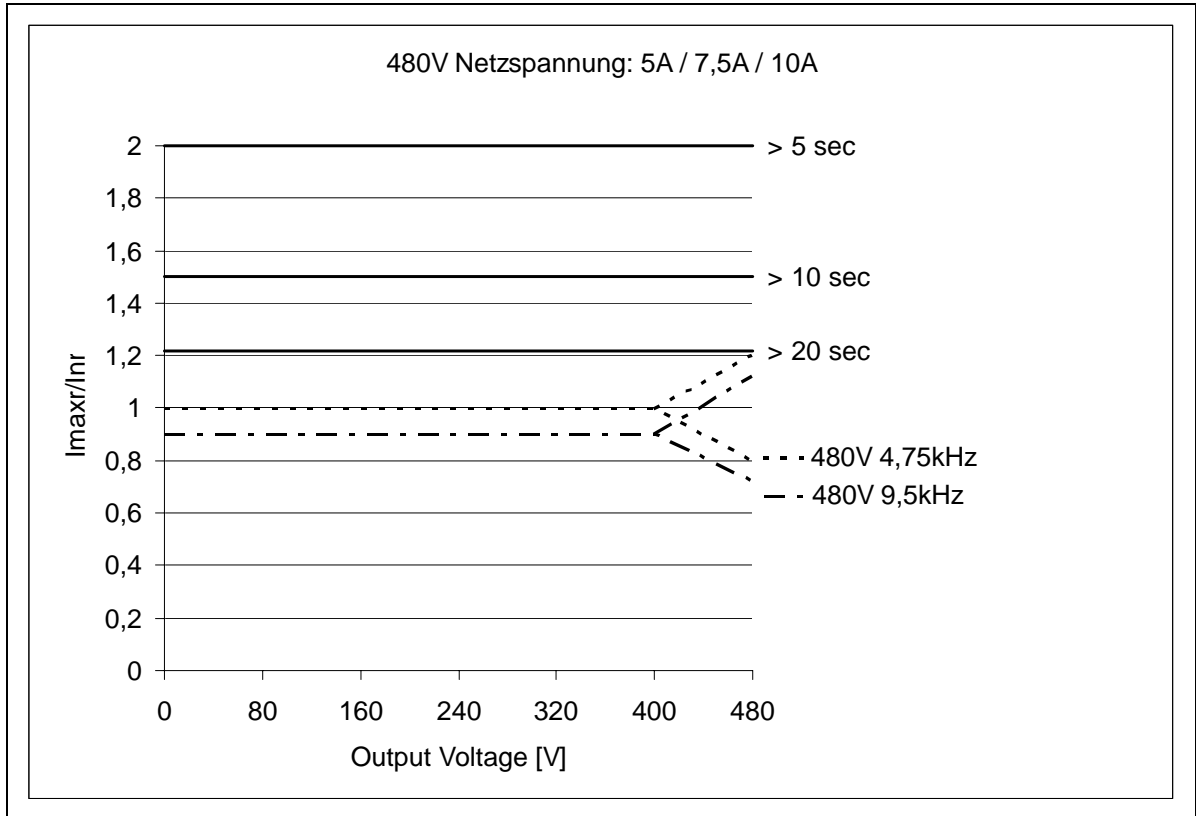



### 13.1 EASYRIDER® Windows - Software

EASYRIDER® Windows software is a useful and convenient tool to use to control all drive functions.

Detailed online help information and instructions are available.

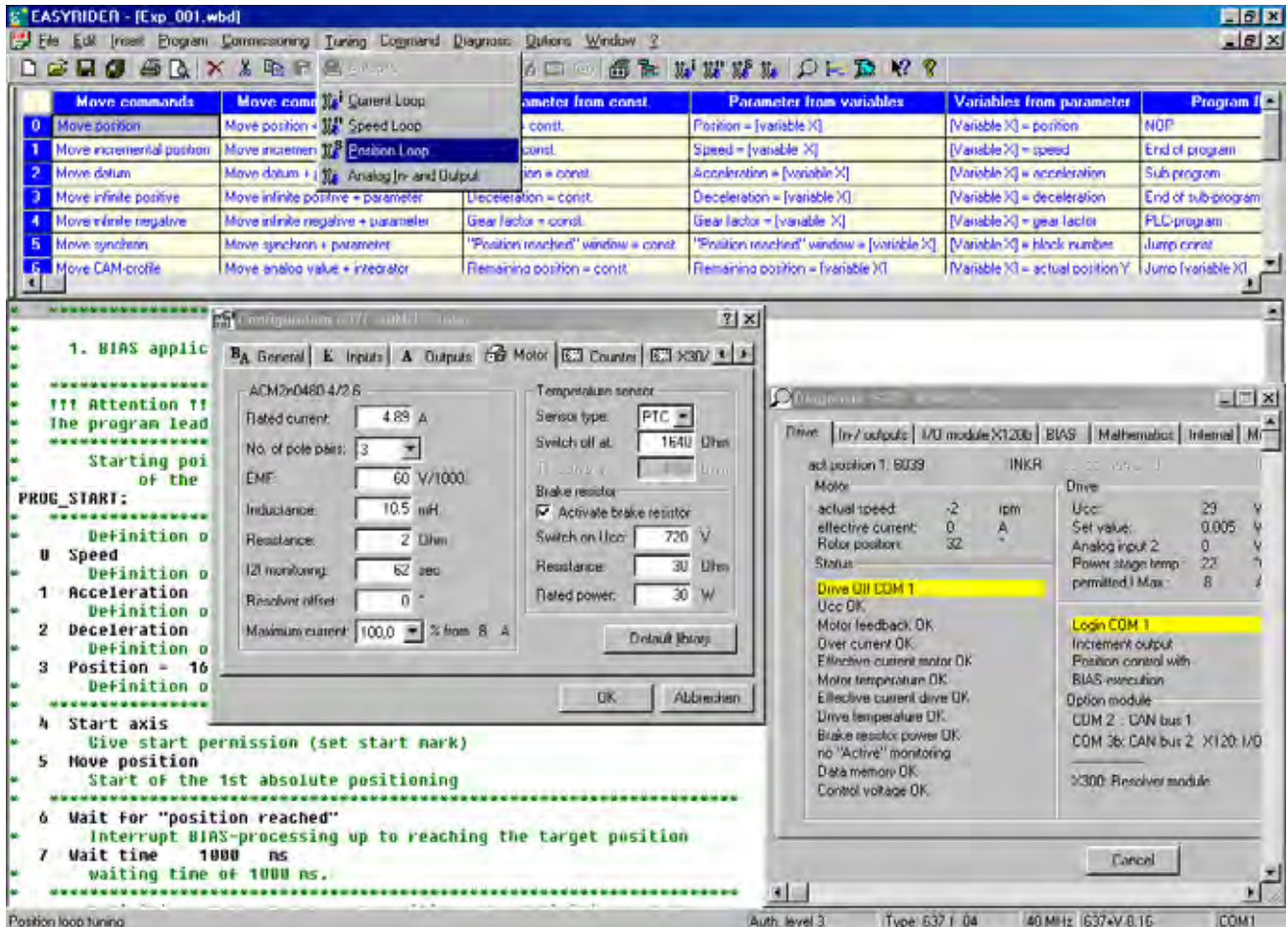

EASYRIDER® Instructions: (extract)

- Auto pilot function as an interactive tutorial
- System identification
- BIAS instruction-set editor
- Oscilloscope function
- Start-up and commissioning tools
- Setting of parameters and setting of configurations
- Servo diagnostics, interface diagnostics and fieldbus diagnostics
- Motor library
- Save system data in file and load system data from file
- Send system data to servo drive and save system data in servo drive
- Load system data from servo drive

#### Important:

Edited data in EASYRIDER® is transmitted to the RAM of the servo drive and becomes **active only after** executing the **SEND** command. **Only the instruction "SAVE in EEPROM"**, writes data into a non volatile memory. Data is stored there in the event of power failure.

# 13 Software

## 13.2 Introduction

The selection of the [Operating Mode 5](#) with the Drives 630 Serie activates the complete functionality of all control loops and the BIAS-program processing.

The [EASYRIDER Software](#) is the programming tool to create, load and save the BIAS Programs.

The programming language "BIAS"

### Bedienersprache für intelligente Antriebs – Steuerungen

was developed to allow the programming of complex and yet clear programs.

Therefore the BIAS commands were divided according to their function into the 12 following command groups:

0. [Move command](#)
1. Move command + parameters
2. [Parameter commands](#)
3. "Parameter from variables" - commands
4. "Parameter into variables" – commands
5. [Control commands](#)
6. [Flag commands](#)
7. [In-/ output commands](#)
8. [Variable commands](#)
9. [Mathematics commands 1](#)
10. Mathematics commands 2
11. Floating point commands

[BIAS – Command overview](#)

With these commands you will be able to program the required machine process in chains of steps  
The size of a program is limited to a maximum of 1500 BIAS commands

The design of the programs occurs with EASYRIDER software at the PC and can be transmitted into the servo drive via serial communication.

If you create the BIAS program with the **EASYRIDER** shell, jump labels, comments and a unit for the position presettings are provided.

A further possibility is programming or transmitting and controlling the BIAS program via a field bus respectively. The necessary command coding is listed in the command instruction.

During the calculation of a BIAS-program is possible to start parallel a PLC SPS-Task and/or a Mathematics-Task.

The PLC-Task is calculated parallel to the BIAS-Task and has a subset of the commands.

Save Table
The command is allowed in the PLC-Task only

The Mathematik-Task is calculated in the interruptfree processing time of the drive and has also subset of the commands.

Profile value = [Variable X]
The command is allowed in the Math only.

- **Program layout**

A BIAS program consists of 3 basic memory areas.

1. **The program definition:**  
contains all definitions for starting and processing a BIAS program, the entries for defining a unit for position presetting and the necessary configurations of the inputs and outputs.
2. **The command memory:**  
contains up to 1500 BIAS commands.
3. **The synchronous parameters:**  
contain the definitions for the 16 synchronous profile blocks and the 2048 supporting points.

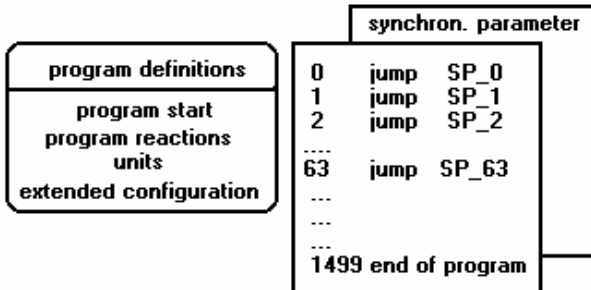

The basic memory areas are part of the BIAS program.  
In the EASYRIDER for Windows Software the extension is \*.WBD.

- **Execute a BIAS program**

The BIAS processing is started in operating mode 5 "position control with BIAS processing" after activating the output stage of the regulator.

The first BIAS block to be executed is determined in the [BIAS program definition](#) (Parameter "program start").

After that, the regulator processes one BIAS command sequentially every trajectory cycle. If the BIAS processing encounters a move command, it can be started with the Low-High slope of the start input.

<b>Serie</b>	<b>Input</b>	<b>Configuration</b>
635/ 637/637+/637f/638:	X10.11	<a href="#">"Start input BIAS" (Function 0)</a>
631:	X10.9	<a href="#">"Start input " (Function 3)</a>

Alternatively, move commands are started when the start identifier is set before the move command, via the BIAS command ["Start axis"](#).

The following blocks will be processed after a successful start.

If the command, ["Wait for "position reached"](#) follows a move command, block processing will only be continued after the target position is reached.

<i>Drive type:</i>	<i>Trajectory cycle:</i>
631/635/637	1,899ms
637+/637f/638	0,844ms

- **Execute a PLC program**

A cyclic PLC program for supervisory monitoring tasks can be started parallel to the sequential processing of a BIAS program

The PLC program is started by processing the BIAS command, "**PLC program**".

After the PLC program is activated the programmed PLC commands are processed as of the specified block number.

The command "**end of program, mode = 0**" within a PLC program causes a jump back to the start of the PLC program.

The regulator processes one PLC command sequentially every trajectory cycle.

The reaction of the PLC program to the deactivation of the output stage can be adjusted in the [BIAS program definition](#) (parameter "program reaction PLC program"). Thus it is possible to allow the PLC program to continue to process also during the deactivation of the regulator. Is in this mode the first command of the BIAS execution the command "PLC program" the PLC task starts automatically independently of the state (deactive/active) of the drive.

In the plc-loop not all of the BIAS commands are allowed.

In the 3 command overview the allowed commands are listed.

The check of allowed commands is done by the drive during run time!

<i>Drive type</i>	<i>Trajectory cycle</i>
631/635/637	1,899ms
637+/637f/638	0,844ms

- **Execute a Mathematics program**

A 3 task as math program for supervisory calculation can be started parallel to the sequential processing of a BIAS program and/or PLC program.

The mathematics-program is started by processing the BIAS command, "**Mathematics program**".

After the mathematics program is activated the programmed mathematics commands are processed as of the specified block number.

The command "**end of program, mode =0**" within a mathematic - program causes a jump back to the start of the mathematics program.

The command "**end of program, mode =3**" cancels the mathematics program.

The reaction of the mathematics program to the deactivation of the output stage can be adjusted in the [BIAS program definition](#) (parameter "program reaction mathematics program").

Thus it is possible to allow the mathematics program to continue to process also during the deactivation of the regulator.

In this mode the command „Mathematic program“ is executed at the first or second line (if the PLC program is on line 1) of the BIAS program or at line 0 , if the drive is not enabled.

The calculation of the mathematics commands is done in the interruptfree calculation time of the drive. In a standard application approx. 10 commands are processed every 2ms

13.3 BIAS - Commands

Position = const.	[Variable X] = position	BIAS-execution pointer	[Variable X] =flag Y	Profile value = [variable X]	Save table	PLC-program
This command is only permitted in the BIAS- task	This command is only permitted in the BIAS, PLC and MATH-Task	This command is only permitted in the PLC and MATH-Task	This command is only permitted in the BIAS and PLC -Task	This command is only permitted in the MATH-Task	This command is only permitted in the MATH-Task	This command is only permitted in the BIAS and MATH-Task

	0	1	2	3	4	5	6	7	8	9	A	B
0	Move position	Move position + parameter	Position = const.	Position = [variable X]	[Variable X] = position	NOP	Flag X = const.	If input X ? const.	[Variable X] = const.	Mathematic program	Table [variable X] = const.	[D Variable X] = [D Variable Y] + [D Variable Z]
1	Move incremental position	Move incremental position + parameter	Speed = const.	Speed = [variable X]	[Variable X] = speed	End of program	If flag X ? const.	If output X ? const.	If [variable X] ? const.	Profile initialization = const.	Table [variable X] = [Y Variable Z]	[D Variable X] = [D Variable Y] - [D Variable Z]
2	Move datum	Move datum + parameter	Acceleration = const.	Acceleration = [Variable X]	[Variable X] = acceleration	Sub- program	Flag X = flag Y	Output X = const.	[Variable X] = [variable Y] + const.	Profile cycle length = [variable X]	[X Variable Y] = Table [variable Z]	[D Variable X] = [D Variable Y] * [D Variable Z]
3	Move infinite positive	Move infinite positive + parameter	Deceleration = const.	Deceleration = [variable X]	[Variable X] = deceleration	End of Sub-program	Flag X = input Y	Output X = flag Y	[Variable X] = [variable Y] - const.	[Variable X] = profile value	[W Variable X] = [Y Variable Z]	[D Variable X] = [D Variable Y] / [D Variable Z]
4	Move infinite negative	Move infinite negative + parameter	Gear factor = const.	Gear factor = [Variable X]	[Variable X] = gear factor	PLC-program	Flag X = output Y	---	[Variable X] = [variable Y] * const.	Profile value = [variable X]	[X Variable Y] = const.	If [D Variable X] ? [D Variable Y]
5	Move synchron	Move synchron + parameter	"Position reached" window = const.	"Position reached" window = [variable X]	[Variable X] = block number	Jump const.	Flag X = flag Y & flag Z	---	[Variable X] = [variable Y] / const.	---	[Variable X] = const.	[D Variable X] = SIN ([D Variable Y])
6	Move CAM profile	Move analogue value + integrator	Remaining position = const.	Remaining position = [variable X]	[Variable X] = actual position Y	Jump [variable X]	Flag X = flag Y   flag Z	---	[Variable X] = flag Y	---	[Variable X] = [variable Y]	[D Variable X] = COS ([D Variable Y])
7	Synchronous settings 1	Move speed + integrator	Ramp filter = const., [variable X]	Maximal current = [variable X]	[Variable X] = analogue input Y	BIAS-Execution pointer = const.	Flag X = flag Y ^ flag Z	---	[Variable X] = [variable Y].bit Z number	Save table	[Variable X] = [variable Y]	[D Variable X] = SQRT ([D Variable Y])
8	Synchronous settings 2	Move speed + variable	Actual position X = const.	Actual position X = [variable Y]	[Variable X] = latch position Y	Wait for "position reached"	Flag X = ! flag Y	IBT- mask number = const.	[Variable X] = [variable Y]	---	[Variable X] = [variable Y] ? [variable Z]	---
9	Move PID: speed	---	If actual position X ? const.	Analogue output X = [variable Y]	[Variable X] = actual speed Y	Wait time = const.	Flag X = status Y	IBT- notification number = const.	If [variable X] ? [variable Y]	---	[Variable X] = [variable Y] ? const.	---
A	Move PID: torque	Cycle length = const.	If actual position X ? [variable Y]	PID scaling	[Variable X] = latch status Y	Wait time = [variable X]	If status X ? const.	CAN Command = [variable X]	[Variable X] = [variable Y] + [variable Z]	---	---	---
B	Set point [axis no.] = const.	Cycle length = [variable X]	Sensor window = const.	Sensor window = [variable X]	[Variable X] = position Y; axis no.	BIAS-execution pointer = [variable X]	Mode X = const.	IBT- data transfer	[Variable X] = [variable Y] - [variable Z]	---	---	---
C	Set point [axis no.] = [variable X]	Load parameter set X = [variable Y]	Sensor position = const.	Sensor position = [variable X]	[Variable X] = value Y	Jump [var.[X]]: length = const.; from	Flag X = [variable Y]	CAN2 Command = [variable X]	[Variable X] = [variable Y] * [variable Z]	---	---	---
D	Move relative	---	Sensor adjustment 1 = const.	Sensor adjustment 1 = [variable X]	[Variable X] = axis status, axis no. Y	Execute X commands	[Variable X]. bit[Y] = const.	---	[Variable X] = [variable Y] / [variable Z]	---	---	---
E	Start axis	---	Sensor adjustment 2 = const.	Sensor adjustment 2 = [variable X]	---	---	If [var. X]. bit Y == const. then jump	---	[Teachvariable X] = [variable Y]	---	---	---
F	Stop axis	Stop axis + parameter	Update parameter	PID parameter	---	Virtual program	Axis state, axis no. X, bit Y = const., [flag Z]	---	[Variable X] = [teachvariable Y]	---	---	---

- [Command group "Move commands"](#)
- [Command group "Parameter commands"](#)
- [Command group "Variable commands"](#)
- [Command group "Flag commands"](#)
- [Command group "Conditional jump commands"](#)

- [Command group "Program control commands"](#)
- [Command group "Mathematic commands"](#)
- [Command group "Output commands"](#)
- [Command group "CAN- Commands"](#)
- [Command group "637f commands"](#)





# 14 Appendix

## 14.1 STO - Safety - Parameter - Report - Proposal

### 1 General Information

Checked according to STO inspection instruction: \_\_\_\_\_  
 Project / Machine: \_\_\_\_\_  
 Drive name: \_\_\_\_\_  
 Inspector name: \_\_\_\_\_

### 2 Safety - Parameter Configuration

Parameter-No.	Parameter description	Parameter value
0	Function X10.22	no Function
		Acknowledgement + Quick Stop
		Acknowledgement
		Quick Stop
1	Active-deceleration time	x 10ms
2	STO-Power On test	deactivate
		activate

### 3 STO Function test according to manual; (638 Product Manual 07-02-12-02-E, Chapter STO)

Step 1 checked   
 Step 2 checked   
 Step 3 checked   
 Step 4 checked

### 4 Acknowledgement according as configuration;

successful checked   
 not used

### 5 Quick Stop according as configuration;

successful checked   
 not used

Quick stop integrator (Commissioning; Supervision) \_\_\_\_\_ rpm/s

Acceptance test date: \_\_\_\_\_

In-service inspection date: \_\_\_\_\_

\_\_\_\_\_  
 Signature inspector

\_\_\_\_\_  
 Signature inspector

Date: \_\_\_\_\_

\_\_\_\_\_  
 Signature inspector









We reserve the right to make technical changes. The data correspond to the current status at the time of printing.

**Parker Hannifin GmbH & Co. KG**  
Electromechanical & Drives  
Automation Group  
Im Sand 14  
D-76669 Bad Schönborn  
Tel. +49(0) 7253/9404-0  
Fax +49(0) 7253/9404-99  
sales.automation@parker.com

**Parker Hannifin GmbH & Co. KG**  
Electromechanical & Drives  
Automation Group  
Robert-Bosch-Straße 22  
D-77656 Offenburg  
Tel. +49(0) 781/509-0  
Fax +49(0) 781/509-98176  
sales.automation@parker.com

**Parker Hannifin GmbH & Co. KG**  
Electromechanical & Drives  
Automation Group  
Von-Humboldt-Straße 10  
D-64646 Heppenheim  
Tel. +49(0) 6252/7982-0  
Fax +49(0) 6252/7982-05  
sales.automation@parker.com



[www.parker-automation.com](http://www.parker-automation.com)