

# H500 Spectrum Analyzer & SA2500 Spectrum Analyzer Programmer Manual



077-0784-00

**Tektronix**



# **H500 Spectrum Analyzer & SA2500 Spectrum Analyzer Programmer Manual**

Revision A

[www.tektronix.com](http://www.tektronix.com)

077-0784-00

**Tektronix**

Copyright © Tektronix. All rights reserved. Licensed software products are owned by Tektronix or its subsidiaries or suppliers, and are protected by national copyright laws and international treaty provisions.

Tektronix products are covered by U.S. and foreign patents, issued and pending. Information in this publication supersedes that in all previously published material. Specifications and price change privileges reserved.

TEKTRONIX and TEK are registered trademarks of Tektronix, Inc.

### **Contacting Tektronix**

Tektronix, Inc.  
14150 SW Karl Braun Drive  
P.O. Box 500  
Beaverton, OR 97077  
USA

For product information, sales, service, and technical support:

- In North America, call 1-800-833-9200.
- Worldwide, visit [www.tektronix.com](http://www.tektronix.com) to find contacts in your area.

---

# Table of Contents

Preface .....	iii
Related Documentation .....	iii

## Getting Started

Getting Started .....	1-1
Overview of the Manual .....	1-1
Configuring the Network Interface .....	1-3
Using the Programmable Interface.....	1-4

## Syntax and Commands

Command Syntax .....	2-1
Backus-Naur Form Definition .....	2-1
SCPI Commands and Queries .....	2-2
IEEE 488.2 Common Commands .....	2-7
Constructed Mnemonics .....	2-7
Command Groups .....	2-8
Functional Groups .....	2-9
Programming Hints .....	2-10
IEEE Common Commands .....	2-11
Abort Commands .....	2-12
Calculate Commands .....	2-13
Marker Mnemonics .....	2-15
Calibration Commands .....	2-16
Display Commands .....	2-17
Fetch Commands .....	2-18
Format Commands .....	2-19
Initiate Commands .....	2-20
Input Commands .....	2-21
Mass Memory Commands .....	2-22
Output Commands .....	2-23
Sense Commands .....	2-24
Status Commands .....	2-25
System Commands .....	2-26
Trace Commands .....	2-27
Trace Mnemonics .....	2-28

Trigger Commands .....	2-29
Unit Commands .....	2-30
Command Descriptions .....	2-31

## Status and Events

Status and Events .....	3-1
Status and Event Reporting System .....	3-1
Status Byte .....	3-1
Standard Event Status Block .....	3-4
Queues .....	3-5
Status and Event Processing Sequence .....	3-6
Synchronizing Execution .....	3-7
Error Messages and Codes .....	3-8
Command Errors .....	3-8
Execution Errors .....	3-9
Device Specific Errors .....	3-11
Query Errors .....	3-11
Status Conditions .....	3-12

## Appendices

Appendix A: Character Charts .....	A-1
Appendix B: SCPI Conformance Information .....	B-1
Appendix C: Sample Source Code .....	C-1
C++ Sample Code .....	C-1
MATLAB Sample Code .....	C-1

---

# Preface

This programmer manual covers the H500 and SA2500 Spectrum Analyzer instruments. It provides information on operating your instrument using an Ethernet network interface.

This manual is composed of the following sections

- *Getting Started* outlines how to configure and use the network interface.
- *Syntax and Commands* defines the syntax used in command descriptions, presents a list of all command subsystems, and presents detailed descriptions of all programming commands.
- *Status and Events* describes how the status and Events Reporting system operates and presents a list of all system errors.
- *Appendices* provides additional information.

## Related Documentation

- *H500 User Manual* (Tektronix part number 071-3115-XX) and *SA2500 User Manual* (Tektronix part number 071-3118-XX). These manuals contain general information about how to put your instrument into service, guides to user interface controls, and application examples.
- *H500 and SA2500 instruments Online Help* The online help contains detailed information about application controls and parameter fields.





---

# Getting Started



# Getting Started

You can write computer programs that remotely set the instrument front panel controls or that take measurements and read those measurements for further analysis or storage. To help you get started with programming the instrument, this section includes the following subsections

- *Overview of the Manual*  
Summarizes each major section of this manual.
- *Configuring the Network Interface*  
Describes how to configure the H500 or SA2500 network interface, and how to physically connect the instrument to a controller.
- *Using the Programmable Interface*  
Describes the communication protocol for using the programmable interface.

## Overview of the Manual

The information contained in each major section of this manual is described below.

### Syntax and Commands

*Syntax and Commands*, describes the structure and content of the messages your program sends to the instrument. The following figure shows command parts as described in the *Command Syntax* subsection.

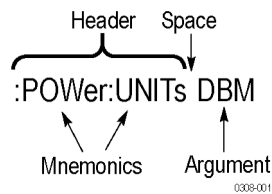

Figure 1-1: Command parts

Section 2 also describes the effect of each command and provides examples of how you might use it. The *Command Groups* subsection provides lists by functional areas. The commands are listed alphabetically in the *Command Descriptions* section.

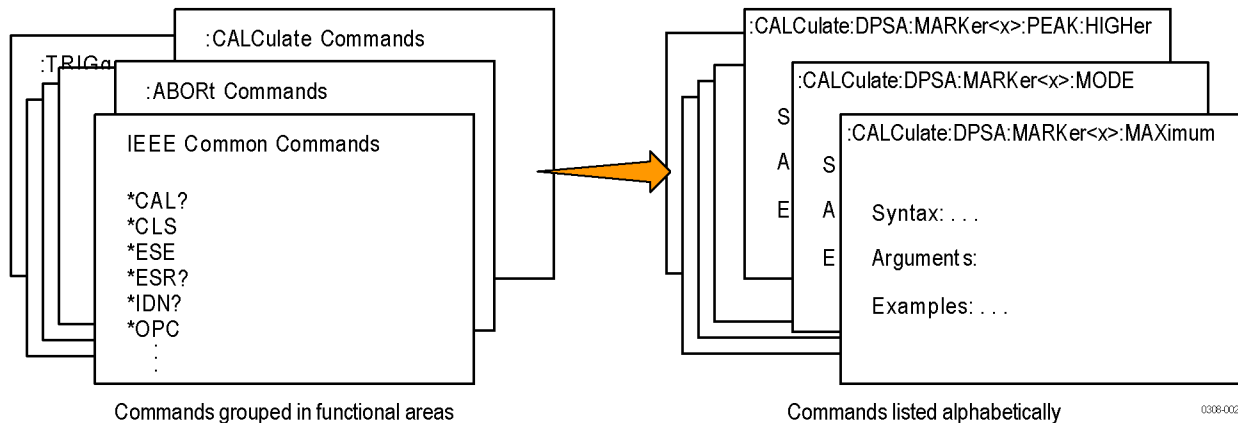

Figure 1-2: Functional groupings and an alphabetical list of commands

**Status and Events**

The program may request information from the instrument. The instrument provides information in the form of status and error messages. The following figure illustrates the basic operation of this system. Section 3, *Status and Events*, describes how to get status or event information from the program and details the event and error messages.

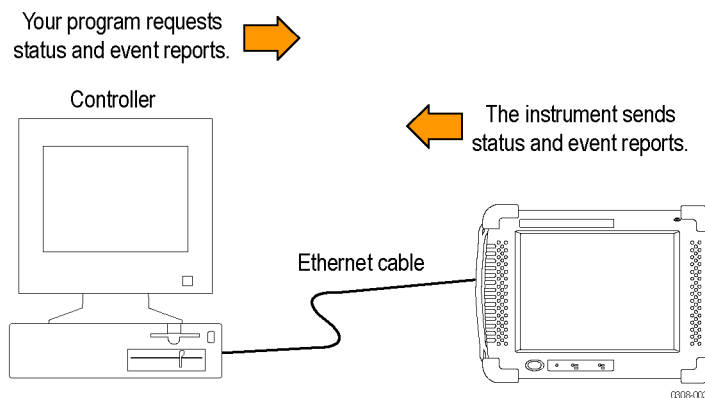
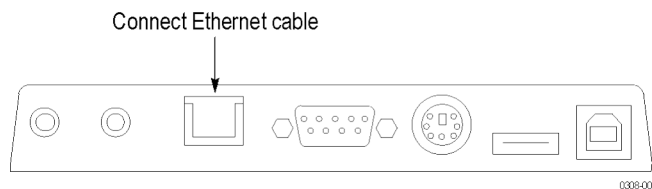

Figure 1-3: Event-driven program

## Configuring the Network Interface

The H500 or SA2500 programmable interface is accessible through the instrument's network interface when the H500 or SA2500 application is running. You must configure instrument network settings before using the programmable interface. Use the following steps to configure the instrument network interface:

1. Work with your network administrator to determine the IP address of the H500 instrument. If the network has DHCP enabled, the instrument will automatically obtain an IP address when powered on and connected to the network. If your network does not support DHCP, or you need a fixed IP address for your instrument, have your system administrator provide you with an address.
2. Connect a standard Ethernet cable from a network connector to the Ethernet port on the top of the instrument. You can do this before or after powering on the instrument.



**Figure 1-4: Instrument ethernet connection**

3. Power on the instrument if it is not already powered on.
4. On the instrument, tap **Start > Settings > Network and Dial-up Connections** to open the **Network Connections** dialog box. The instrument network interface is listed as ENDS4ISA1.
5. Double-tap the **ENDS4ISA1** icon to open the **CSA8900 Settings** dialog box:
  - If your instrument is using DHCP to obtain an IP address, and the **Obtain an IP address via DHCP** button is set, you do not need any further network configuration. Close the dialog box and continue to the next numbered step.
  - If the instrument has already been assigned a fixed IP address, the address fields should show the address information.
  - If you are assigning or changing the instrument fixed IP address, tap the **Specify an IP address** button, enter the appropriate address settings, and tap **OK**.
6. Close the **Network Connections** dialog box. You can now use the network interface to control the H500 or SA2500 application using the network-accessed programmable interface.

## Using the Programmable Interface

The H500 and SA2500 programmable interface consists of simple text commands. These are modeled after the Standard Commands for Programmable Instruments (SCPI) syntax. As an example of a typical command, `:SENS:FREQ:CENT?` requests the spectrum analyzer's center frequency. The instrument uses raw TCP sockets to receive commands and send replies. To send a command to the H500 or SA2500, make a connection on TCP port 34835 and send the text of the command, followed by a newline (ASCII 10). The instrument will reply on the same TCP port, and will add a newline to the end of its response.

Appendix C lists C++ source code that uses the Win32 Winsock library to interface to the H500 or SA2500. Included is a custom library module with routines for opening and closing the interface, writing commands, reading query responses, and determining details when error conditions occur. Also included is a test wrapper that uses the custom library module to perform basic instrument operations. Appendix C also lists MATLAB code that uses the MATLAB Instrument Control Toolbox plug-in to interface to the H500 or SA2500. The MATLAB example opens the interface, sends a simple query command, and then reads the response. The example files are provided as attachments to this PDF file.

---

# Syntax and Commands





---

# Command Syntax

This section contains information on the Standard Commands for Programmable Instruments (SCPI) and IEEE 488.2 Common Commands you can use to program your H500 or SA2500 instrument. The information is organized in the following subsections

- Backus-Naur Form Definition
- SCPI Commands and Queries
- IEEE 488.2 Common Commands
- Constructed Mnemonics

## Backus-Naur Form Definition

This manual may describe commands and queries using the Backus-Naur Form (BNF) notation. The following table defines the standard BNF symbols.

**Table 2-1: BNF symbols and meanings**

<b>Symbol</b>	<b>Meaning</b>
< >	Defined element
:=	Is defined as
	Exclusive OR
{ }	Group; one element is required
[ ]	Optional; can be omitted
... .	Previous element(s) may be repeated
( )	Comment

## SCPI Commands and Queries

SCPI is a standard created by a consortium that provides guidelines for remote programming of instruments. These guidelines provide a consistent programming environment for instrument control and data transfer. This environment uses defined programming messages, instrument responses, and data format across all SCPI instruments, regardless of manufacturer. The instrument uses a command language based on the SCPI standard.

The SCPI language is based on a hierarchical or tree structure as shown in the following figure that represents a subsystem. The top level of the tree is the root node; it is followed by one or more lower-level nodes.

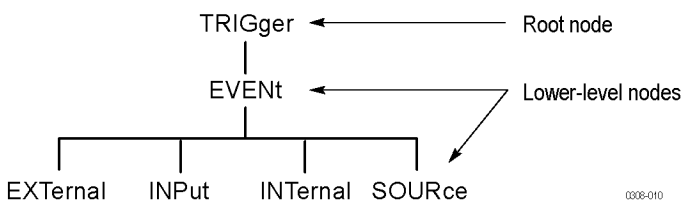

**Figure 2-1: Example of SCPI subsystem hierarchy tree**

You can create commands and queries from these subsystem hierarchy trees. Commands specify actions for the instrument to perform. Queries return measurement data and information about parameter settings.

### Creating Commands

SCPI commands are created by stringing together the nodes of a subsystem hierarchy and separating each node by a colon.

In the figure above, TRIGger is the root node and EVENT, EXTernal, INPut, INTernal, and SOURce are lower-level nodes. To create a SCPI command, start with the root node TRIGger and move down the tree structure adding nodes until you reach the end of a branch. Most commands and some queries have parameters; you must include a value for these parameters. If you specify a parameter value that is out of range, the parameter will be set to a default value. The command descriptions list the valid values for all parameters.

For example, :TRIGger:EVENT:INTernal BOTH is a valid SCPI command created from the hierarchy tree. (See Figure 2-1.)

### Creating Queries

To create a query, start at the root node of a tree structure, move down to the end of a branch, and add a question mark. TRIGger:EVENT:SOURce? is an example of a valid SCPI query using the hierarchy tree in the figure. (See Figure 2-1.)

**Query Responses** The query causes the instrument to return information about its status or settings. When a query is sent to the instrument, only the values are returned. When the returned value is a mnemonic, it is noted in abbreviated format, as shown in the following table.

**Table 2-2: Query response examples**

Query	Response
CALCulate:SPECTrum:MARKer:X	7.50E+9
TRACe1:DPSA:DETection	AVER

A few queries also initiate an operation action before returning information. For example, the \*CAL? query runs a calibration.

**Parameter Types** Every parameter in the command and query descriptions is of a specified type. The parameters are enclosed in brackets, such as <value>. The parameter type is listed after the parameter and is enclosed in parentheses, for example, (boolean). Some parameter types are defined specifically for the H500 and SA2500 instruments command set and some are defined by ANSI/IEEE 488.2-1987 as shown in the following table.

**Table 2-3: Parameter types used in syntax descriptions**

Parameter type	Description	Example
arbitrary block <sup>1</sup>	A specified length of arbitrary data	#512234xxxx . . . where 5 indicates that the following 5 digits (12234) specify the length of the data in bytes; xxxx ... indicates the data
boolean	Boolean numbers or values	ON or 1; OFF or 0
binary	Binary numbers	#B0110
octal	Octal numbers	#Q57, #Q3
hexadecimal <sup>2</sup>	Hexadecimal numbers (0-9, A, B, C, D, E, F)	#HAA, #H1
NR1 <sup>2</sup> numeric	Integers	0, 1, 15, -1
NR2 <sup>2,3</sup> numeric	Decimal numbers	1.2, 3.141516, -6.5
NR3 <sup>2</sup> numeric	Floating point numbers	3.1415E-9, -16.1E5
NRf <sup>2</sup> numeric	Flexible decimal number that may be type NR1, NR2 or NR3	See NR1, NR2, and NR3 examples
string <sup>4</sup>	Alphanumeric characters (must be within quotation marks)	"Testing 1, 2, 3"

<sup>1</sup> Defined in ANSI/IEEE 488.2 as "Definite Length Arbitrary Block Response Data."

<sup>2</sup> An ANSI/IEEE 488.2-1992-defined parameter type.

<sup>3</sup> Some commands and queries will accept an octal or hexadecimal value even though the parameter type is defined as NR1.

<sup>4</sup> Defined in ANSI/IEEE 488.2 as "String Response Data."

**Special Characters**

All characters in the range of ASCII 127-255 are defined as special characters. These characters are used in arbitrary block arguments only; using these characters in other parts of any command yields unpredictable results.

**Abbreviating Commands, Queries, and Parameters**

You can abbreviate most SCPI commands, queries, and parameters to an accepted short form. This manual shows these short forms as a combination of upper and lower case letters. The upper case letters indicate the accepted short form of a command. As shown in the following figure, you can create a short form by using only the upper case letters. The accepted short form and the long form are equivalent and request the same action of the instrument.

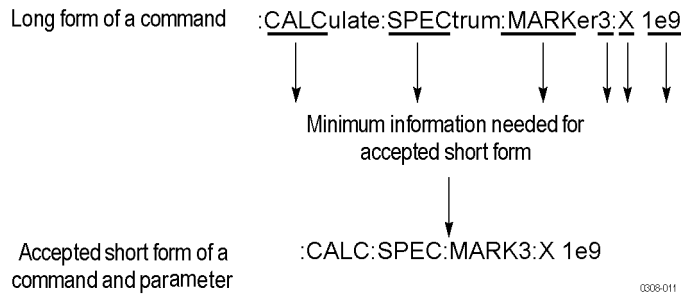

**Figure 2-2: Example of abbreviating a command**

### Chaining Commands and Queries

You can chain several commands or queries together into a single message. To create a chained message, first create a command or query, add a semicolon (;), and then add more commands or queries and semicolons until the message is complete. If the command following a semicolon is a root node, precede it with a colon (:). The following figure illustrates a chained message consisting of several commands and queries. The single chained message should end in a command or query, not a semicolon. Responses to any queries in your message are separated by semicolons.

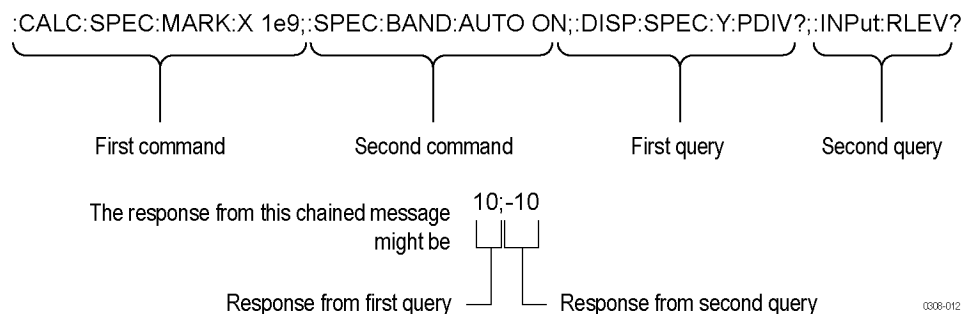

**Figure 2-3: Example of chaining commands and queries**

If a command or query has the same root and lower-level nodes as the previous command or query, you can omit these nodes. In the following figure, the second command has the same root node (`TRIGger:EVENT`) as the first command, so these nodes can be omitted.

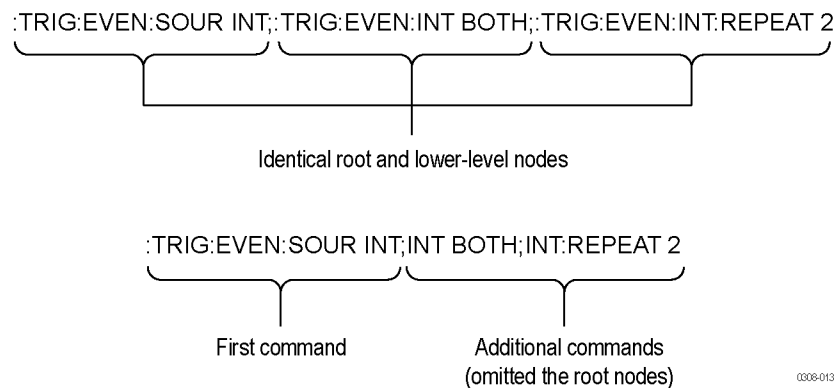

**Figure 2-4: Example of omitting root and lower-level nodes in a chained message**

**General Rules**

Here are three general rules for using SCPI commands, queries, and parameters:

- You can use single ( ' ') or double ( " ") quotation marks for quoted strings, but you cannot use both types of quotation marks for the same string.

correct        "This string uses quotation marks correctly."

correct        'This string also uses quotation marks correctly.'

incorrect      "This string does not use quotation marks correctly.'

- You can use upper case, lower case, or a mixture of both cases for all commands, queries, and parameters.

      :SENSE:DPSA:COLOR:MAXIMUM 50

is the same as

      :sense:dpsa:color:maximum 50

and

      :SENSE:dpsa:COLOR:maximum 50

---

**NOTE.** *Literal strings (quoted) are case sensitive, for example, file names.*

---

- No embedded spaces are allowed between or within nodes.

correct        :SENSE:DPSA:COLOR:MAXIMUM 50

incorrect      :SENSE: DPSA: COLOR:MAXI MUM 50

## IEEE 488.2 Common Commands

**Description** ANSI/IEEE Standard 488.2 defines the codes, formats, protocols, and usage of common commands and queries used on the interface between the controller and the instruments. The instrument complies with this standard.

**Command and Query Structure** The syntax for an IEEE 488.2 common command is an asterisk (\*) followed by a command and, optionally, a space and parameter value. The syntax for an IEEE 488.2 common query is an asterisk (\*) followed by a query and a question mark. All of the common commands and queries are listed in the last part of the *Syntax and Commands* section. The following are examples of common commands:

- \*ESE 16
- \*CLS

The following are examples of common queries

- \*ESR
- \*IDN

## Constructed Mnemonics

Some header mnemonics specify one of a range of mnemonics. For example, a trace mnemonic can be either TRACe1, TRACe2, TRACe3, TRACe4, or TRACe5. You use these mnemonics in the command just as you do any other mnemonic. For example, there is a TRACe1:SPECTrum:FUNCTion command, and there is also a TRACe2:SPECTrum:FUNCTion command. In the command descriptions, this list of choices is abbreviated as TRACe<x>. The value of <x> is the upper range of valid suffixes. If the numeric suffix is omitted, the instrument uses the default value of "1".

**Table 2-4: Constructed mnemonics**

Symbol	Meaning
MARKer<x>	A marker specifier where <x> = 0, 1, 2, 3, 4, 5, or 6. Refer to <i>Marker Mnemonics</i> .
TRACe<x>	A trace specifier where <x> = 1, 2, 3, 4, or 5. Refer to <i>TRACe Commands</i> for details.

## Command Groups

This section lists the H500 and SA2500 instrument commands in two ways. It first presents them by functional groups. It then lists them alphabetically. The functional group list starts below. The alphabetical list provides more detail on each command.

The H500 and SA2500 instruments conform to the Standard Commands for Programmable Instruments (SCPI) 1999.0 and IEEE Std 488.2-1987 except where noted.

Items followed by question marks are queries; items without question marks are commands. Some items in this section have a question mark in parentheses () in the command header section; this indicates that the item can be both a command and a query.

For the conventions of notation in this manual, refer to *Command Syntax* and following pages.



## Functional Groups

All commands are divided into groups as shown in the following table.

**Table 2-5: List of command group**

<b>Command group</b>	<b>Function</b>
IEEE common	Conforms to the IEEE Std 488.2.
ABORt	Resets the trigger system and stops measurements.
CALCulate	Controls the markers and the search operations.
CALibration	Controls the external correction.
DISPlay	Controls the display of measurement results and waveforms.
FETCh	Retrieves measurements from the latest INITiate command data.
INITiate	Controls data acquisition.
INPut	Controls the characteristics of the signal input.
MMEMory	Provides mass storage capabilities for the instrument.
OUTPut	Controls the characteristics of the signal output.
SENSe	Sets up detailed conditions for each measurement.
STATus	Queries measurement mode status.
SYSTem	Sets or queries system parameters for operation.
TRACe	Controls trace activation and math operations.
TRIGger	Controls triggering.
UNIT	Specifies fundamental units for measurement.

## Programming Hints

Here are some basic tips for using the H500 and SA2500 commands:

- *Selecting a measurement mode*  
Use Display commands to select or display a measurement mode.  
[Example] `DISP:GEN:MEASVIEW:NEW SPECTRUM`  
Selects the Spectrum measurement mode.
- *Setting measurement parameters*  
Use Sense commands to set conditions for the measurement session.  
[Example] `SENSE:SPECTRUM:FREQUENCY:CENTER 1.5e9`  
Sets the center frequency to 1.5 GHz in the Spectrum measurement mode.
- *Acquiring an input signal*  
Use an Initiate or Abort command to start or stop data acquisition.  
[Example] `INITIATE:CONTINUOUS ON;INITIATE:IMMEDIATE`  
Starts data acquisition in the continuous mode.
- *Processing waveforms arithmetically*  
Use Trace commands for math operation on waveforms.  
[Example] `TRACE1:SPECTRUM:FUNCTION AVERAGE`  
Averages the spectrum waveform.
- *Measuring with the markers*  
Use Calculate commands to measure some quantity using the markers.  
[Example] `CALCULATE:SPECTRUM:MARKER1:MAXIMUM`  
Positions the marker at the highest peak signal on the spectrum.
- *Obtaining the measurement results*  
Use a Fetch command to get the results.  
[Example] `FETCH:SPECTRUM:TRACE1`  
Returns the spectrum trace data.
- *Scaling the waveform*  
Use Display commands to change the waveform portion on screen.  
[Example] `DISP:SPECTRUM:Y:SCALE:PDIVISION 5`  
Sets the scale to 5 dB per division in the Spectrum measurement mode.

The following sections list the commands by group.

# IEEE Common Commands

The IEEE 488.2 common commands have a "\*" prefix.

**Table 2-6: Status and error commands**

<b>Header</b>	<b>Description</b>
*CAL?	Runs and returns the instrument normalization status.
*CLS	Clears status.
*ESE	Sets or queries the bits in the ESER register.
*ESR?	Returns the contents of the SESR register.
*IDN?	Returns the instrument identification code.
*OPC	Synchronizes commands.
*RST	Returns the instrument settings to the factory defaults.
*SRE	Sets or queries the bits in the SRER register.
*TRG	Generates a trigger.
*WAI	Prevents the instrument from executing further commands.

## Abort Commands

Use the Abort commands to reset the trigger system and to stop measurements.

**Table 2-7: Abort commands**

Header	Description
<a href="#">ABORT</a>	Resets the trigger system and places the instrument in a paused state.

# Calculate Commands

Use the Calculate commands to control the markers and the search operations.

Table 2-8: Calculate commands

Header	Description
<b>CALCulate:AVTime subgroup</b>	<b>Amplitude vs. Time measurement</b>
CALCulate:AVTime:MARKer<x>:MAXimum	Moves the marker to the highest peak on the trace.
CALCulate:AVTime:MARKer<x>:MODE	Sets or queries the markers absolute/delta readout mode.
CALCulate:AVTime:MARKer<x>:PEAK:HIGHer	Moves the marker to the next peak higher in amplitude on the trace.
CALCulate:AVTime:MARKer<x>:PEAK:LEFT	Moves the marker to the next peak to the left on the trace.
CALCulate:AVTime:MARKer<x>:PEAK:LOWer	Moves the marker to the next peak lower in amplitude on the trace.
CALCulate:AVTime:MARKer<x>:PEAK:RIGHT	Moves the marker to the next peak to the right on the trace.
CALCulate:AVTime:MARKer<x>:STATE	Sets or queries the enable/disable state of the marker.
CALCulate:AVTime:MARKer<x>:TRACE	Sets or queries the trace on which the specified marker is placed.
CALCulate:AVTime:MARKer<x>:X	Sets or queries the current time position of the specified marker.
CALCulate:AVTime:MARKer<x>:Y?	Queries the vertical position of the marker.
<b>CALCulate:DPSA subgroup</b>	<b>DPX spectrum measurement</b>
CALCulate:DPSA:MARKer<x>:MAXimum	Moves the marker to the highest peak on the trace.
CALCulate:DPSA:MARKer<x>:MODE	Sets or queries the markers absolute/delta readout mode.
CALCulate:DPSA:MARKer<x>:PEAK:HIGHer	Moves the marker to the next peak higher in amplitude on the trace.
CALCulate:DPSA:MARKer<x>:PEAK:LEFT	Moves the marker to the next peak to the left on the trace.
CALCulate:DPSA:MARKer<x>:PEAK:LOWer	Moves the marker to the next peak lower in amplitude on the trace.
CALCulate:DPSA:MARKer<x>:PEAK:RIGHT	Moves the marker to the next peak to the right on the trace.
CALCulate:DPSA:MARKer<x>[:SET]:CENTer	Sets the center frequency to the marker frequency.
CALCulate:DPSA:MARKer<x>:STATE	Sets or queries the enable/disable state of the marker.
CALCulate:DPSA:MARKer<x>:X	Sets or queries the frequency position of the marker.
CALCulate:DPSA:MARKer<x>:Y?	Queries the vertical position of the marker.
<b>CALCulate:MARKer subgroup</b>	
CALCulate:MARKer:PEAK:THReshold	Sets or queries the threshold level to detect peaks.
<b>CALCulate:SEARCh subgroup</b>	
CALCulate:SEARCh:LIMit:FAIL?	Query whether or not the current acquisition has a mask violation.
CALCulate:SEARCh:LIMit:MATCH:BEEP[:STATE]	Sets or queries whether to beep when a mask violation occurs.
CALCulate:SEARCh:LIMit:MATCH:SACQuire[:STATE]	Sets or queries whether to stop acquiring data when a mask violation occurs.
CALCulate:SEARCh:LIMit:MATCH:SPICture[:STATE]	Sets or queries whether to perform a screen save when a mask violation occurs.
CALCulate:SEARCh:LIMit:MATCH:STRace[:STATE]	Sets or queries whether to save the waveform trace when a mask violation occurs.
CALCulate:SEARCh:LIMit:OPERation:MASK:LOAD	Loads the spectrum mask from a specified file for the search operation.

Table 2-8: Calculate commands (cont.)

Header	Description
<a href="#">CALCulate:SEARch:LIMit:STATe</a>	Sets or queries whether to enable or disable the search function (spectrum mask mode).
<b>CALCulate:SPECTrum subgroup</b>	<b>Spectrum measurement</b>
<a href="#">CALCulate:SPECTrum:MARKer&lt;x&gt;:MAXimum</a>	Moves the specified marker to the highest peak on the trace.
<a href="#">CALCulate:SPECTrum:MARKer&lt;x&gt;:MODE</a>	Sets or queries the markers absolute/delta readout mode.
<a href="#">CALCulate:SPECTrum:MARKer&lt;x&gt;:PEAK:HIGHer</a>	Moves the marker to the next peak higher in amplitude on the trace.
<a href="#">CALCulate:SPECTrum:MARKer&lt;x&gt;:PEAK:LEFT</a>	Moves the marker to the next peak to the left on the trace.
<a href="#">CALCulate:SPECTrum:MARKer&lt;x&gt;:PEAK:LOWer</a>	Moves the marker to the next peak lower in amplitude on the trace.
<a href="#">CALCulate:SPECTrum:MARKer&lt;x&gt;:PEAK:RIGHT</a>	Moves the marker to the next peak to the right on the trace.
<a href="#">CALCulate:SPECTrum:MARKer&lt;x&gt;[:SET]:CENTer</a>	Sets the center frequency to the marker frequency.
<a href="#">CALCulate:SPECTrum:MARKer&lt;x&gt;:STATe</a>	Sets or queries the enable/disable state of the marker.
<a href="#">CALCulate:SPECTrum:MARKer&lt;x&gt;:TRACe</a>	Sets or queries the trace on which the marker is placed.
<a href="#">CALCulate:SPECTrum:MARKer&lt;x&gt;:X</a>	Sets or queries the horizontal position of the marker.
<a href="#">CALCulate:SPECTrum:MARKer&lt;x&gt;:Y?</a>	Queries the vertical position of the marker.

## Marker Mnemonics

Up to seven markers can be used. In commands, these are named MARKer<x>, where <x> can be 0, 1, 2, 3, 4, 5, or 6 as shown in the following table.

**Table 2-9: Marker mnemonics**

Mnemonic	Description
MARKer0	Measurement frequency marker
MARKer1	Marker 1 (M1)
MARKer2	Marker 2 (M2)
MARKer3	Marker 3 (M3)
MARKer4	Marker 4 (M4)
MARKer5	Marker 5 (M5)
MARKer6	Marker 6 (M6)

---

**NOTE.** *If you omit the numeric suffix, the marker control defaults to Marker 1.*

*Before operating the marker, you have to enable it using the CALCulate basic commands.*

*If you attempt to use a marker other than above in a CALCulate command, the suffix error (error code -130) will occur.*

---

# Calibration Commands

Use the CALibration commands to control signal corrections.

**Table 2-10: Calibration commands**

<b>Header</b>	<b>Description</b>
<a href="#">CALibration:AUTO</a>	Sets or queries the whether or not automatic normalizations should occur.
<a href="#">CALibration:CORRection:EXTernal:GAIN[MAGNitude]</a>	Sets or queries the external gain/loss value.
<a href="#">CALibration:CORRection:EXTernal:GAIN:STATe</a>	Sets or queries whether to enable or disable the external gain/loss value.



# Display Commands

Use the DISPLAY commands to control the display of measurement waveforms and results on the screen.

Table 2-11: Display commands

Header	Description
<b>DISPlay:AVTime subgroup</b>	<b>Amplitude vs. Time measurement</b>
<a href="#">DISPlay:AVTime:MARKer:SHOW:STATe</a>	Sets or queries the current marker display mode.
<a href="#">DISPlay:AVTime:Y[:SCALE]:OFFSet</a>	Sets or queries the vertical position.
<a href="#">DISPlay:AVTime:Y[:SCALE]:PDIVision</a>	Sets or queries the vertical scale (per division).
<b>DISPlay:DPSA subgroup</b>	<b>DPX spectrum measurement</b>
<a href="#">DISPlay:DPSA:MARKer:SHOW:STATe</a>	Sets or queries the current DPSA marker display mode.
<b>DISPlay:GENeral subgroup</b>	<b>General signal viewing</b>
<a href="#">DISPlay:GENeral:MEASview:NEW</a>	Sets the current measurement mode.
<a href="#">DISPlay:GENeral:MEASview:SElect</a>	Sets or queries the current measurement mode.
<b>DISPlay:SPECtrum subgroup</b>	<b>Spectrum measurement</b>
<a href="#">DISPlay:SPECtrum:MARKer:SHOW:STATe</a>	Sets or queries the current Spectrum marker display mode.
<a href="#">DISPlay:SPECtrum:Y[:SCALE]:OFFSet</a>	Sets or queries the vertical position.
<a href="#">DISPlay:SPECtrum:Y[:SCALE]:PDIVision</a>	Sets or queries the vertical scale (per division).

## Fetch Commands

Use the FETCh commands to retrieve the measurements from the data taken by the latest INITiate command.

For the trace specifier TRACe<x>, refer to Trace Mnemonics. (See page 2-28.)

**Table 2-12: Fetch commands**

Header	Description
<a href="#">FETCh:AVTime:TRACe&lt;x&gt;?</a>	Queries the Amplitude vs. Time trace data for the specified trace.
<a href="#">FETCh:DPSA:BITMap?</a>	Query the DPX Spectrum hit count data.
<a href="#">FETCh:DPSA:TRACe1?</a>	Query the DPX Spectrum waveform data.
<a href="#">FETCh:SPECTrum:TRACe&lt;x&gt;?</a>	Query the spectrum waveform data for the specified trace.

---

# Format Commands

Use the FORMat commands to control the format of ASCII and binary data.

Table 2-13: Format commands

Header	Description
<a href="#">FORMat:[DATA]</a>	Set binary or ASCII format for certain parameters and/or query responses.
<a href="#">FORMat:[DATA]:LOGGing</a>	Set binary or ASCII format for data logging mode.

# Initiate Commands

Use the INITiate commands to control the acquisition of data.

**Table 2-14: Initiate commands**

Header	Description
<a href="#">INITiate:CONTinuous</a>	Sets or queries whether to acquire data continuously.
<a href="#">INITiate:IMMEDIATE</a>	Starts data acquisition.

# Input Commands

Use the INPut commands to control the characteristics of the signal input.

Table 2-15: Input commands

Header	Description
<a href="#">INPut:ALEVel</a>	Perform an auto-level.
<a href="#">INPut:RLEVel</a>	Sets or queries the reference level.
<b>RF: subgroup</b>	
<a href="#">INPut[:RF]:ATTenuation</a>	Sets or queries the input attenuation.
<a href="#">INPut[:RF]:GAIN:STATe</a>	Sets or queries whether to enable the internal preamplifier.

# Mass Memory Commands

Use the MMEMemory commands to manipulate files on the mass memory devices.

For the trace specifier TRACe<x>, refer to *Trace Mnemonics*. (See page 2-28.)

Table 2-16: Mass memory (MMEMemory) commands

Header	Description
<b>MMEMemory basic command subgroup</b>	<b>General file control</b>
MMEMemory:APPData:PREFIX	Sets or queries the prefix to use for automatically generated filenames.
MMEMemory:APPData:RESults	Sets or queries the default directory location for measurement results.
MMEMemory:APPData:RESults:DEFault:EXPort:FORMat	Sets or queries the default measurement results ASCII export format.
MMEMemory:APPData:RESults:DEFault:SCReen:FORMat	Sets or queries the default screen image export format.
MMEMemory:APPData:RESults:DELeTe	Deletes the specified file from the current measurement results directory.
MMEMemory:APPData:RESults:EXISts?	Queries to see if a specified file exists in the current measurement results directory.
MMEMemory:APPData:RESults:INIT	Sets the measurement results directory to the factory default value.
MMEMemory:APPData:SETTings	Sets or queries the default directory location for stored settings.
MMEMemory:APPData:SETTings:DELeTe	Deletes a specified file from the current stored settings directory.
MMEMemory:APPData:SETTings:EXISts?	Queries to see if a specified file exists in the current stored settings directory.
MMEMemory:APPData:SETTings:INIT	Sets the stored settings directory to the factory default value.
MMEMemory:APPData:USERsettings	Set or queries the location of the default directory for user settings.
MMEMemory:APPData:USERsettings:DELeTe	Deletes the specified file from the current user settings directory.
MMEMemory:APPData:USERsettings:EXISts?	Queries to see if a specified file exists in the current user settings directory.
MMEMemory:APPData:USERsettings:INIT	Sets the user settings directory to its factory default value.
MMEMemory:DELeTe	Deletes the specified file from the specified path location.
MMEMemory:EXISts?	Queries to see if a specified file exists at the specified path.
MMEMemory:LOAD:RESults	Loads the previously stored measurement result from a specified file.
MMEMemory:LOAD:STATe	Loads the instrument setup from a specified file.
MMEMemory:SPECTrum:LOAD:TRACe<x>	Loads the spectrum trace data from the specified file.
MMEMemory:STORe:IQ	Stores time-domain IQ data to a specified IQT-format file.
MMEMemory:STORe:IQ:CSV	Stores time-domain IQ data to a specified CSV-format file.
MMEMemory:STORe:IQ:MAT	Stores time-domain IQ data to a specified Matlab-format file.
MMEMemory:STORe:RESults	Store the current measurement results in binary or ASCII format.
MMEMemory:STORe:SCReen	Stores the screen image in a specified file.
MMEMemory:STORe:STATe	Stores the instrument setup in a specified file.

# Output Commands

Use the OUTPut commands to control the characteristics of the signal output.

**Table 2-17: Output commands**

<b>Header</b>	<b>Description</b>
<a href="#">OUTPut:IF[:STATe]</a>	Sets or queries whether to turn on or off IF output.

# Sense Commands

Use the SENSE commands to set up detailed measurement conditions.

Table 2-18: Sense commands

Header	Description
<b>[SENSe] basic command subgroup</b>	<b>General analysis parameter control</b>
[SENSe]:POWer:UNITs	Sets or queries the measurement unit of power.
[SENSe]:ROSCillator:SOURce?	Queries the reference oscillator source.
<b>[SENSe]:AVTime subgroup</b>	<b>Amplitude vs. Time measurement</b>
[SENSe]:AVTime:ACQuisition:MODE	Sets or queries the signal acquisition time mode.
[SENSe]:AVTime:ACQuisition:RATE?	Queries the measurement sample rate.
[SENSe]:AVTime:ACQuisition:SAMPLEs	Sets or queries the number of acquisition samples.
[SENSe]:AVTime:ACQuisition:SEConds	Sets or queries the acquisition time.
[SENSe]:AVTime:FREQuency:MEASurement	Sets or queries the measurement frequency.
[SENSe]:AVTime:FREQuency:SPAN	Sets or queries the measurement span.
[SENSe]:AVTime:MAX:SPAN	Sets the measurement frequency span to the maximum allowable span.
<b>[SENSe]:DPSA subgroup</b>	<b>DPX spectrum measurement</b>
[SENSe]:DPSA:CLEar:RESults	Resets the max hold or average trace and the bitmap.
[SENSe]:DPSA:COLor	Sets or queries the bitmap color mode.
[SENSe]:DPSA:COLor:MAXimum	Sets or queries the maximum value of the color axis.
[SENSe]:DPSA:COLor:MINimum	Sets or queries the minimum value of the color axis.
[SENSe]:DPSA:FREQuency:CENTer	Sets or queries the center frequency.
[SENSe]:DPSA:FREQuency:MEASurement	Sets or queries the measurement frequency.
[SENSe]:DPSA:FREQuency:SPAN	Sets or queries the frequency span.
[SENSe]:DPSA:MAX:SPAN	Sets the frequency span to the maximum span.
<b>[SENSe]:SPECtrum subgroup</b>	<b>Spectrum measurement</b>
[SENSe]:SPECtrum:{BANDwidth BWIDth}[:RESolution]	Sets or queries the resolution bandwidth (RBW).
[SENSe]:SPECtrum:{BANDwidth BWIDth}[:RESolution]:AUTO	Sets or queries whether to set the RBW automatically.
[SENSe]:SPECtrum:FREQuency:CENTer	Sets or queries the center frequency.
[SENSe]:SPECtrum:FREQuency:MEASurement	Sets or queries the measurement frequency.
[SENSe]:SPECtrum:FREQuency:SPAN	Sets or queries the frequency span.
[SENSe]:SPECtrum:FREQuency:SPAN:BANDwidth[:RESolution]:RATio	Sets or queries the ratio of span to RBW.
[SENSe]:SPECtrum:FREQuency:START	Sets or queries the measurement start frequency.
[SENSe]:SPECtrum:FREQuency:STOP	Sets or queries the measurement stop frequency.
[SENSe]:SPECtrum:MAX:SPAN	Sets the frequency span to the maximum span.



---

# Status Commands

Use the STATus commands to query measurement mode status.

**Table 2-19: Status commands**

<b>Header</b>	<b>Description</b>
<a href="#">STATus:AVTime:EVENTs?</a>	Queries the Amplitude vs. Time measurement event and status condition.
<a href="#">STATus:DPXA:EVENTs?</a>	Queries the DPX Spectrum measurement event and status condition.
<a href="#">STATus:SPECTrum:EVENTs?</a>	Queries the Spectrum measurement event and status condition.

# System Commands

Use the SYSTem commands to set or query system parameters for operation.

**Table 2-20: System commands**

Header	Description
SYSTem:COMMunicate:LOGGing:GPS[:SOCKET]: ADDRess	Sets or queries the UDP address at which to store the GPS time/location logging files.
SYSTem:COMMunicate:LOGGing:GPS[:SOCKET]: PORT	Sets or queries the UDP port at which to store GPS time/location logging files.
SYSTem:COMMunicate:LOGGing:RESults[:SOCKET]: ADDRess	Sets or queries the UDP address at which to store the measurement result logging files.
SYSTem:COMMunicate:LOGGing:RESults[:SOCKET]: PORT	Sets or queries the UDP port at which to store GPS time/location logging files.
SYSTem:DATE?	Queries the current instrument date.
SYSTem:ERRor:COUNt?	Queries the number of unread errors or events.
SYSTem:ERRor[:NEXT]?	Queries the latest error or event information.
SYSTem:GPS	Sets or queries the GPS operational mode.
SYSTem:GPS:POSition?	Query the current GPS position.
SYSTem:GPS:STATus?	Query the current GPS status.
SYSTem:LOGGing:GPS	Sets or queries the GPS time/location logging mode.
SYSTem:LOGGing:GPS:FILE[:NAME]	Sets or queries the GPS time/location data logging file name.
SYSTem:LOGGing:RESults	Sets or queries the measurement result logging mode.
SYSTem:LOGGing:RESults:FILE[:NAME]	Sets or queries measurement results logging file name.
SYSTem:TIME?	Queries the current instrument time.

# Trace Commands

Use the TRACe commands to select trace type and to control trace arithmetic.

Table 2-21: Trace commands

Header	Description
<b>TRACe&lt;x&gt;:AVTime subgroup</b>	<b>Amplitude vs. Time measurement</b>
TRACe<x>:AVTime	Sets or queries whether to show or hide the specified trace.
TRACe<x>:AVTime:AVERage:COUNT	Sets or queries the number of traces to combine for averaging.
TRACe<x>:AVTime:AVERage:PROGress?	Queries the number of times the average trace has been averaged.
TRACe<x>:AVTime:AVERage:RESet	Clears the average data and resets the average counter.
TRACe<x>:AVTime:COUNT:RESet	Clears the Max or Min Hold data and counter, and restarts the process.
TRACe<x>:AVTime:DETection	Sets or queries the detection (decimate) algorithm.
TRACe<x>:AVTime:FOReground	Sets or queries the foreground trace.
TRACe<x>:AVTime:FUNCTion	Sets or queries the trace function.
<b>TRACe&lt;x&gt;:DPSA subgroup</b>	<b>DPX spectrum measurement</b>
TRACe<x>:DPSA:AVERage:COUNT	Sets or queries the number of traces to combine for averaging.
TRACe<x>:DPSA:AVERage:PROGress?	Queries the number of times the average trace has been averaged.
TRACe<x>:DPSA:AVERage:RESet	Clears the average data and resets the average counter.
TRACe<x>:DPSA:COLor:INTensity	Sets or queries the color intensity.
TRACe<x>:DPSA:COUNT:RESet	Clears the Max Hold data and counter, and restarts the process.
TRACe<x>:DPSA:DETection	Sets or queries the detection (decimate) algorithm.
TRACe<x>:DPSA:DOT:PERsistent	Sets or queries whether to enable or disable dot persistence mode.
TRACe<x>:DPSA:DOT:PERsistent:TYPE	Sets or queries the persistence type.
TRACe<x>:DPSA:DOT:PERsistent:VARiable	Sets or queries the length of time that data points are displayed.
TRACe<x>:DPSA:FUNCTion	Sets or queries the trace function.
<b>TRACe&lt;x&gt;:SPECtrum subgroup</b>	<b>Spectrum measurement</b>
TRACe<x>:SPECtrum	Sets or queries whether to show or hide the specified trace.
TRACe<x>:SPECtrum:AVERage:COUNT	Sets or queries the number of traces to combine for averaging.
TRACe<x>:SPECtrum:AVERage:PROGress?	Queries the number of times the average trace has been averaged.
TRACe<x>:SPECtrum:AVERage:RESet	Clears the average data and resets the average counter.
TRACe<x>:SPECtrum:COUNT:RESet	Clears the Max or Min Hold data and counter, and restarts the process.
TRACe<x>:SPECtrum:DETection	Sets or queries the detection (decimate) algorithm.
TRACe<x>:SPECtrum:FOReground	Sets or queries the foreground trace.
TRACe<x>:SPECtrum:FUNCTion	Sets or queries the trace function.
TRACe<x>:SPECtrum:LEFToperand	Sets or queries the left operand for the math trace.
TRACe<x>:SPECtrum:LOAD:TRACe	Load a live trace into a reference trace.
TRACe<x>:SPECtrum:OPERation	Sets or queries the math trace operation.
TRACe<x>:SPECtrum:RIGHToperand	Sets or queries the right operand for the math trace.

## Trace Mnemonics

Multiple traces can be used in some measurement modes. The traces are specified by the trace specifier TRACe<x> (<x>=1 to 5) which is defined for each measurement display as follows.

**Table 2-22: Trace mnemonics**

Measurement mode	TRACe1	TRACe2	TRACe3	TRACe4	TRACe5
Amplitude vs. Time	Trace 1	Trace 2	NA	NA	NA
DPX Spectrum	Trace 1	NA	NA	NA	Bitmap trace
Spectrum	Trace 1	Trace 2	Ref A	Ref B	Math

---

**NOTE.** *Valid traces depend on commands. Refer to each command description.*

---

# Trigger Commands

Use the TRIGger commands to set up the trigger system.

Table 2-23: Trigger commands

Header	Description
TRIGger[:SEquence]:EVENT:EXTernal:SLOPe	Sets or queries the external trigger slope type.
TRIGger[:SEquence]:EVENT:INPut:LEVel	Sets or queries the trigger level for the IF input level trigger.
TRIGger[:SEquence]:EVENT:INPut:SLOPe	Sets or queries the trigger slope for the IF input level trigger.
TRIGger[:SEquence]:EVENT:INTernal	Sets or queries the internal time base trigger mode.
TRIGger[:SEquence]:EVENT:INTernal:REPeat	Sets or queries the internal time base trigger repeat interval time.
TRIGger[:SEquence]:EVENT:INTernal:TIME	Sets or queries the internal time base trigger start time.
TRIGger[:SEquence]:EVENT:SOURce	Sets or queries the trigger event source.
TRIGger[:SEquence]:IMMEDIATE	Causes a trigger immediately.
TRIGger[:SEquence]:STATus	Sets or queries the trigger mode (Free Run or Triggered).
TRIGger[:SEquence]:TIME:DELay	Sets or queries the trigger delay time.

## Unit Commands

Specify fundamental units for measurement.

**Table 2-24: Unit commands**

Header	Description
<a href="#">UNIT:POWer</a>	Sets or queries the measurement unit of power.

---

# Command Descriptions

## ABORt (No Query Form)

Resets the trigger system and places the instrument in a paused state. Any actions related to the trigger system that are in progress, such as acquiring a measurement, are also aborted.

To start data acquisition, use the INITiate commands.

**Conditions** Measurement modes: All

**Group** Abort commands

**Syntax** ABORt

**Related Commands** [INITiate:CONTinuous](#)  
[INITiate\[:IMMediate\]](#)

**Arguments** None

**Examples** ABORt resets the trigger system and stops data acquisition.

## \*CAL? (Query Only)

Runs and returns the instrument normalization status.

**Conditions** Spectrum and Amplitude vs. Time modes

**Group** IEEE common commands

**Syntax** \*CAL?

**Arguments** None

**Returns** <NR1>, where:  
1 indicates the instrument has completed a measurement normalization process with no errors.

0 indicates the instrument has completed a measurement normalization process with errors, or normalization on the instrument is disabled, or the instrument is not in Spectrum or Amplitude vs. Time mode.

**Examples** \*CAL? might return 1 indicating that the instrument has completed a measurement normalization process with no errors.

## CALCulate:AVTime:MARKer<x>:MAXimum (No Query Form)

Moves the specified Amplitude vs. Time mode marker to the maximum peak on the Amplitude vs. Time trace. Valid marker <x> values are 1 through 6.

This command is ignored, and an error event generated, when the specified marker is not enabled, marker display is disabled, or the instrument is not in Amplitude vs. Time mode.

**Conditions** Measurement modes: Amplitude vs. Time

**Group** Calculate commands

**Syntax** CALCulate:AVTime:MARKer<x>:MAXimum

**Arguments** None

**Examples** CALCulate:AVTime:MARKer3:MAXimum moves Marker 3 (M3) to the highest peak on the Amplitude vs. Time trace.

## CALCulate:AVTime:MARKer<x>:MODE

Sets or queries the specified Amplitude vs. Time marker to absolute or delta measurement mode (in relation to Marker 1). Valid marker <x> values are 1 through 6. Marker 1 is always absolute.

This command is ignored and an error event generated when the specified marker is not enabled, marker display is disabled, or the instrument is not in Amplitude vs. Time mode.

**Conditions** Measurement modes: Amplitude vs. Time

**Group** Calculate commands



<b>Syntax</b>	<code>CALCulate:AVTime:MARKer&lt;x&gt;:MODE { ABSolute   DELTa }</code> <code>CALCulate:AVTime:MARKer&lt;x&gt;:MODE?</code>
<b>Arguments</b>	<code>ABSolute</code> sets the specified marker to absolute measurement mode. <code>DELTA</code> sets the specified marker to delta measurement mode, in relation to marker 1.
<b>Examples</b>	<code>CALCULATE:AVTime:MARKER4:MODE ABSolute</code> sets Marker 4 (M4) to measure the absolute value at the specified marker position. <code>CALCULATE:AVTime:MARKER3:MODE?</code> might return <code>DELT</code> , indicating that the specified marker is set to delta measurement mode.

## **CALCulate:AVTime:MARKer<x>:PEAK:HIGHer (No Query Form)**

Moves the specified marker to the next peak on the Amplitude vs. Time trace that is higher than the current marker position and is above the current marker peak threshold. Valid marker <x> values are 1 through 6.

This command is ignored and an error event generated when the specified marker is not enabled, marker display is disabled, or the instrument is not in Amplitude vs. Time mode.

<b>Conditions</b>	Measurement modes: Amplitude vs. Time
<b>Group</b>	Calculate commands
<b>Syntax</b>	<code>CALCulate:AVTime:MARKer&lt;x&gt;:PEAK:HIGHer</code>
<b>Related Commands</b>	<a href="#">CALCulate:AVTime:MARKer&lt;x&gt;:PEAK:LEFT</a> <a href="#">CALCulate:AVTime:MARKer&lt;x&gt;:PEAK:LOWer</a> <a href="#">CALCulate:AVTime:MARKer&lt;x&gt;:PEAK:RIGHT</a> <a href="#">CALCulate:MARKer:PEAK:THReshold</a>
<b>Arguments</b>	None
<b>Examples</b>	<code>CALCULATE:AVTime:MARKER2:PEAK:HIGHER</code> moves Marker 2 (M2) to the next peak higher in amplitude on the trace.

## CALCulate:AVTime:MARKer<x>:PEAK:LEFT (No Query Form)

Moves the specified marker to the next peak on the Amplitude vs. Time trace that is to the left of the current marker position and is above the current marker peak threshold. Valid marker <x> values are 1 through 6.

This command is ignored and an error event generated when the specified marker is not enabled, marker display is disabled, or the instrument is not in Amplitude vs. Time mode.

<b>Conditions</b>	Measurement modes: Amplitude vs. Time
<b>Group</b>	Calculate commands
<b>Syntax</b>	CALCulate:AVTime:MARKer<x>:PEAK:LEFT
<b>Related Commands</b>	<a href="#">CALCulate:AVTime:MARKer&lt;x&gt;:PEAK:HIGHer</a> <a href="#">CALCulate:AVTime:MARKer&lt;x&gt;:PEAK:LOWer</a> <a href="#">CALCulate:AVTime:MARKer&lt;x&gt;:PEAK:RIGHT</a> <a href="#">CALCulate:MARKer:PEAK:THReshold</a>
<b>Arguments</b>	None
<b>Examples</b>	CALCULATE:AVTime:MARKER5:PEAK:LEFT moves Marker 5 (M5) to the next peak to the left on the trace.

## CALCulate:AVTime:MARKer<x>:PEAK:LOWer (No Query Form)

Moves the specified marker to the next peak on the Amplitude vs. Time trace that is lower than the current marker position and is above the current marker peak threshold. Valid marker <x> values are 1 through 6.

This command is ignored and an error event generated when the specified marker is not enabled, marker display is disabled, or the instrument is not in Amplitude vs. Time mode.

<b>Conditions</b>	Measurement modes: Amplitude vs. Time
<b>Group</b>	Calculate commands
<b>Syntax</b>	CALCulate:AVTime:MARKer<x>:PEAK:LOWer

<b>Related Commands</b>	<a href="#">CALCulate:AVTime:MARKer&lt;x&gt;:PEAK:HIGHer</a> <a href="#">CALCulate:AVTime:MARKer&lt;x&gt;:PEAK:LEFT</a> <a href="#">CALCulate:AVTime:MARKer&lt;x&gt;:PEAK:RIGHT</a> <a href="#">CALCulate:MARKer:PEAK:THReshold</a>
<b>Arguments</b>	None
<b>Examples</b>	CALCULATE:AVTime:MARKER2:PEAK:LOWER moves Marker 2 (M2) to the next peak lower in amplitude on the trace.

## CALCulate:AVTime:MARKer<x>:PEAK:RIGHT (No Query Form)

Moves the specified marker to the next peak on the Amplitude vs. Time trace that is to the right of the current marker position and is above the current marker peak threshold. Valid marker <x> values are 1 through 6.

This command is ignored and an error event generated when the specified marker is not enabled, marker display is disabled, or the instrument is not in Amplitude vs. Time mode.

<b>Conditions</b>	Measurement modes: Amplitude vs. Time
<b>Group</b>	Calculate commands
<b>Syntax</b>	CALCulate:AVTime:MARKer<x>:PEAK:RIGHT
<b>Related Commands</b>	<a href="#">CALCulate:AVTime:MARKer&lt;x&gt;:PEAK:HIGHer</a> <a href="#">CALCulate:AVTime:MARKer&lt;x&gt;:PEAK:LEFT</a> <a href="#">CALCulate:AVTime:MARKer&lt;x&gt;:PEAK:LOWer</a> <a href="#">CALCulate:MARKer:PEAK:THReshold</a>
<b>Arguments</b>	None
<b>Examples</b>	CALCULATE:AVTime:MARKER2:PEAK:RIGHT moves Marker 2 (M2) to the next peak to the right on the trace.

## CALCulate:AVTime:MARKer<x>:STATE

Sets or queries the enable/disable state of the specified Amplitude vs. Time mode marker. Valid marker <x> values are 1 through 6.

This command is ignored and an error event generated when the instrument is not in Amplitude vs. Time mode.

<b>Conditions</b>	Measurement modes: Amplitude vs. Time
<b>Group</b>	Calculate commands
<b>Syntax</b>	<code>CALCulate:AVTime:MARKer&lt;x&gt;:STATE { OFF   ON   0   1 }</code> <code>CALCulate:AVTime:MARKer&lt;x&gt;:STATE?</code>
<b>Arguments</b>	ON or 1 enables the specified marker. OFF or 0 disables the specified marker.
<b>Examples</b>	<code>CALCulate:AVTime:MARKer5:STATE ON</code> enables Marker 5 (M5). <code>CALCulate:AVTime:MARKer2:STATE?</code> might return 0 to indicate that Marker 2 (M2) is not enabled.

## CALCulate:AVTime:MARKer<x>:TRACE

Sets or queries the trace on which the specified marker is placed in the Amplitude vs. Time measurement mode. Valid marker <x> values are 1 through 6.

This command is ignored and an error event generated when the instrument is not in Amplitude vs. Time measurement mode, the display or markers are currently disabled, the specified marker is not enabled, or the specified trace is not enabled.

<b>Conditions</b>	Measurement modes: Amplitude vs. Time
<b>Group</b>	Calculate commands
<b>Syntax</b>	<code>CALCulate:AVTime:MARKer&lt;x&gt;:TRACE { TRACE1   TRACE2   FOREground }</code> <code>CALCulate:AVTime:MARKer&lt;x&gt;:TRACE?</code>
<b>Arguments</b>	TRACE1 places the specified marker on Trace 1. TRACE2 places the specified marker on Trace 2. FOREground places the specified marker on the front-most (selected) trace.

- Examples**    `CALCulate:AVTime:MARKer1:TRACE` TRACe1 places Marker 1 (M1) on Trace 1.
- `CALCULATE:AVTime:MARKER2:TRACE?` might return TRAC2, indicating that the marker is on the Trace 2 waveform.

## CALCulate:AVTime:MARKer<x>:X

Sets or queries the time value at the position of the Amplitude vs. Time mode marker on the Amplitude vs. Time trace. Valid marker <x> values are 1 through 6.

When the specified maker is enabled and set to absolute marker mode, the return value of the query is a NRf type equal to the specified markers current time. When the specified maker is enabled and set to delta marker mode, the return value of the query is a NRf type equal to the difference between the specified marker time and the marker 1 time.

This command is ignored and an error event generated when the specified marker is not enabled, marker display is disabled, or the instrument is not in Amplitude vs. Time mode.

**Conditions**    Measurement modes: Amplitude vs. Time

**Group**    Calculate commands

**Syntax**    `CALCulate:AVTime:MARKer<x>:X <value>`  
`CALCulate:AVTime:MARKer<x>:X?`

**Related Commands**    [CALCulate:AVTime:MARKer<x>:Y?](#)

**Arguments**    <value> ::= <NRf> specifies the horizontal (time) position of the marker.  
 Range: allowable time range of the instrument.

**Examples**    `CALCULATE:AVTime:MARKER3:X 100e-3` places Marker 3 (M3) at the 100 ms position on the Amplitude vs. Time trace.

## CALCulate:AVTime:MARKer<x>:Y? (Query Only)

Queries the vertical position (amplitude) of the specified marker in the Amplitude vs. Time trace. Valid marker <x> values are 1 through 6.

When the specified maker is enabled and set to absolute marker mode, the return value of the query is a NRf type equal to the specified markers current amplitude.

When the specified marker is enabled and set to delta marker mode, the return value of the query is a NRf type equal to the difference between the specified marker amplitude and the marker 1 amplitude.

This command is ignored and an error event generated when the specified marker is not enabled, marker display is disabled, or the instrument is not in Amplitude vs. Time mode.

<b>Conditions</b>	Measurement modes: Amplitude vs. Time
<b>Group</b>	Calculate commands
<b>Syntax</b>	CALCulate:AVTime:MARKer<x>:Y?
<b>Related Commands</b>	<a href="#">CALCulate:AVTime:MARKer&lt;x&gt;:X</a>
<b>Arguments</b>	None
<b>Returns</b>	<NRf> specifies the markers absolute or delta amplitude, in current power units, as specified by the UNIT:POWER command.
<b>Examples</b>	CALCULATE:AVTime:MARKER1:Y? might return -34.28, indicating that Marker 1 (M1) is at -34.28 dBm.

## CALCulate:DPXA:MARKer<x>:MAXimum (No Query Form)

Moves the specified DPX mode marker to the maximum peak on the DPX spectrum trace. Valid marker <x> values are 0 through 6.

This command is ignored and an error event generated when the specified marker is not enabled, marker display is disabled, or the instrument is not in DPX Spectrum mode.

<b>Conditions</b>	Measurement modes: DPX Spectrum
<b>Group</b>	Calculate commands
<b>Syntax</b>	CALCulate:DPXA:MARKer<x>:MAXimum

<b>Arguments</b>	None
<b>Examples</b>	<code>CALCULATE:DPSA:MARKER3:MAXIMUM</code> moves Marker 3 (M3) to the highest peak on the DPX Spectrum trace.

## CALCulate:DPSA:MARKer<x>:MODE

Sets or queries the specified DPX marker to absolute or delta measurement mode (in relation to Marker 1). Valid marker <x> values are 1 through 6. Marker 1 is always absolute.

This command is ignored and an error event generated when the specified marker is not enabled, marker display is disabled, or the instrument is not in DPX Spectrum mode.

<b>Conditions</b>	Measurement modes: DPX Spectrum
<b>Group</b>	Calculate commands
<b>Syntax</b>	<code>CALCulate:DPSA:MARKer&lt;x&gt;:MODE { ABSolute   DELTa }</code> <code>CALCulate:DPSA:MARKer&lt;x&gt;:MODE?</code>
<b>Arguments</b>	<code>ABSolute</code> sets the specified marker to absolute measurement mode. <code>DELTA</code> sets the specified marker to delta measurement mode, in relation to marker 1.
<b>Examples</b>	<code>CALCULATE:DPSA:MARKER4:MODE ABSolute</code> sets Marker 4 (M4) to measure the absolute value at the specified marker position. <code>CALCULATE:DPSA:MARKER3:MODE?</code> might return <code>DELT</code> , indicating that the specified marker is set to delta measurement mode.

## CALCulate:DPSA:MARKer<x>:PEAK:HIGHer (No Query Form)

Moves the specified marker to the next peak on the DPX spectrum trace that is higher than the current marker position and is above the current marker peak threshold. Valid marker <x> values are 0 through 6.

This command is ignored and an error event generated when the specified marker is not enabled, marker display is disabled, or the instrument is not in DPX Spectrum mode.

<b>Conditions</b>	Measurement modes: DPX Spectrum
<b>Group</b>	Calculate commands
<b>Syntax</b>	<code>CALCulate:DPSA:MARKer&lt;x&gt;:PEAK:HIGHer</code>
<b>Related Commands</b>	<a href="#">CALCulate:AVTime:MARKer&lt;x&gt;:PEAK:LOWer</a> <a href="#">CALCulate:MARKer:PEAK:THReshold</a>
<b>Arguments</b>	None
<b>Examples</b>	<code>CALCULATE:DPSA:MARKER2:PEAK:HIGHER</code> moves Marker 2 (M2) to the next peak higher in amplitude on the trace.

## **CALCulate:DPSA:MARKer<x>:PEAK:LEFT (No Query Form)**

Moves the specified marker to the next peak on the DPX spectrum trace that is to the left of the current marker position and is above the current marker peak threshold. Valid marker <x> values are 0 through 6.

This command is ignored and an error event generated when the specified marker is not enabled, marker display is disabled, or the instrument is not in DPX Spectrum mode.

<b>Conditions</b>	Measurement modes: DPX Spectrum
<b>Group</b>	Calculate commands
<b>Syntax</b>	<code>CALCulate:DPSA:MARKer&lt;x&gt;:PEAK:LEFT</code>
<b>Related Commands</b>	<a href="#">CALCulate:AVTime:MARKer&lt;x&gt;:PEAK:RIGHT</a> <a href="#">CALCulate:MARKer:PEAK:THReshold</a>
<b>Arguments</b>	None
<b>Examples</b>	<code>CALCULATE:DPSA:MARKER5:PEAK:LEFT</code> moves Marker 5 (M5) to the next peak to the left on the trace.



## CALCulate:DPSA:MARKer<x>:PEAK:LOWer (No Query Form)

Moves the specified marker to the next peak on the DPX spectrum trace that is lower than the current marker position and is above the current marker peak threshold. Valid marker <x> values are 0 through 6.

This command is ignored and an error event generated when the specified marker is not enabled, marker display is disabled, or the instrument is not in DPX Spectrum mode.

**Conditions** Measurement modes: DPX Spectrum

**Group** Calculate commands

**Syntax** CALCulate:DPSA:MARKer<x>:PEAK:LOWer

**Related Commands** [CALCulate:AVTime:MARKer<x>:PEAK:HIGHer](#)  
[CALCulate:MARKer:PEAK:THReshold](#)

**Arguments** None

**Examples** CALCULATE:DPSA:MARKER2:PEAK:LOWER moves Marker 2 (M2) to the next peak lower in amplitude on the trace.

## CALCulate:DPSA:MARKer<x>:PEAK:RIGHT (No Query Form)

Moves the specified marker to the next peak on the DPX spectrum trace that is to the right of the current marker position and is above the current marker peak threshold. Valid marker <x> values are 0 through 6.

This command is ignored and an error event generated when the specified marker is not enabled, marker display is disabled, or the instrument is not in DPX Spectrum mode.

**Conditions** Measurement modes: DPX Spectrum

**Group** Calculate commands

**Syntax** CALCulate:DPSA:MARKer<x>:PEAK:RIGHT

<b>Related Commands</b>	<a href="#">CALCulate:AVTime:MARKer&lt;x&gt;:PEAK:LEFT</a> <a href="#">CALCulate:MARKer:PEAK:THReshold</a>
<b>Arguments</b>	None
<b>Examples</b>	CALCULATE:DPSA:MARKER2:PEAK:RIGHT moves Marker 2 (M2) to the next peak to the right on the trace.

## CALCulate:DPSA:MARKer<x>[:SET]:CENTer (No Query Form)

Sets the measurement center frequency to that of the specified DPX mode marker frequency. Valid marker <x> values are 0 through 6.

This command is ignored and an error event generated when the specified marker is not enabled, marker display is disabled, or the instrument is not in DPX Spectrum mode.

<b>Conditions</b>	Measurement modes: DPX Spectrum
<b>Group</b>	Calculate commands
<b>Syntax</b>	CALCulate:DPSA:MARKer<x>[:SET]:CENTer
<b>Arguments</b>	None
<b>Examples</b>	CALCULATE:DPSA:MARKER1:SET:CENTER sets the center frequency to the frequency of marker 1.

## CALCulate:DPSA:MARKer<x>:STATe

Sets or queries the enable/disable state of the specified DPX mode marker. Valid marker <x> values are 0 through 6.

This command is ignored and an error event generated when the instrument is not in DPX Spectrum mode.

<b>Conditions</b>	Measurement modes: DPX Spectrum
<b>Group</b>	Calculate commands

<b>Syntax</b>	<code>CALCulate:DPSA:MARKer&lt;x&gt;:STATE { OFF   ON   0   1 }</code> <code>CALCulate:DPSA:MARKer&lt;x&gt;:STATE?</code>
<b>Arguments</b>	ON or 1 enables the specified marker. OFF or 0 disables the specified marker.
<b>Examples</b>	<code>CALCulate:DPSA:MARKer5:STATE ON</code> enables Marker 5 (M5). <code>CALCulate:DPSA:MARKer2:STATE?</code> might return 0 to indicate that Marker 2 (M2) is not enabled.

## CALCulate:DPSA:MARKer<x>:X

Sets or queries the frequency value at the position of the specified marker in the DPX spectrum view. Valid marker <x> values are 0 through 6.

When the specified maker is enabled and set to absolute marker mode, the return value of the query is a NRf type equal to the specified markers current frequency. When the specified maker is enabled and set to delta marker mode, the return value of the query is a NRf type equal to the difference between the specified markers frequency and the marker 1 frequency.

This command is ignored and an error event generated when the specified marker is not enabled, marker display is disabled, or the instrument is not in DPX Spectrum mode.

<b>Conditions</b>	Measurement modes: DPX Spectrum
<b>Group</b>	Calculate commands
<b>Syntax</b>	<code>CALCulate:DPSA:MARKer&lt;x&gt;:X &lt;value&gt;</code> <code>CALCulate:DPSA:MARKer&lt;x&gt;:X?</code>
<b>Related Commands</b>	<a href="#">CALCulate:AVTime:MARKer&lt;x&gt;:Y?</a>
<b>Arguments</b>	<value> ::= <NRf> specifies the frequency position of the marker. Range: allowable frequency range of the instrument.
<b>Examples</b>	<code>CALCULATE:DPSA:MARKER3:X:FREQUENCY 800e6</code> places Marker 3 (M3) at 800 MHz.

## CALCulate:DPSA:MARKer<x>:Y? (Query Only)

Queries the amplitude (vertical) value at the position of the specified marker in the DPX spectrum view. Valid marker <x> values are 0 through 6.

When the specified maker is enabled and set to absolute marker mode, the return value of the query is a NRf type equal to the specified markers current amplitude. When the specified maker is enabled and set to delta marker mode, the return value of the query is a NRf type equal to the difference between the specified markers amplitude and the marker 1 amplitude.

This command is ignored and an error event generated when the specified marker is not enabled, marker display is disabled, or the instrument is not in DPX Spectrum mode.

<b>Conditions</b>	Measurement modes: DPX Spectrum
<b>Group</b>	Calculate commands
<b>Syntax</b>	CALCulate:DPSA:MARKer<x>:Y?
<b>Arguments</b>	None
<b>Returns</b>	<NRf> The specified markers absolute or delta amplitude, in current power units, as specified by the UNIT:POWER command.
<b>Examples</b>	CALCULATE:DPSA:MARKER1:Y? might return -34.28, indicating that Marker 1 (M1) is at -34.28 dBm of the DPX waveform trace.

## CALCulate:MARKer:PEAK:THReshold

Sets or queries the threshold value that determines the minimum peak amplitude for marker peak searches.

<b>Conditions</b>	Measurement modes: All
<b>Group</b>	Calculate commands
<b>Syntax</b>	CALCulate:MARKer:PEAK:THReshold <value> CALCulate:MARKer:PEAK:THReshold?

<b>Related Commands</b>	<p> CALCulate:AVTime:MARKer&lt;x&gt;:PEAK:HIGHer  CALCulate:AVTime:MARKer&lt;x&gt;:PEAK:LEFT  CALCulate:AVTime:MARKer&lt;x&gt;:PEAK:LOWer  CALCulate:AVTime:MARKer&lt;x&gt;:PEAK:RIGHT  CALCulate:DPSA:MARKer&lt;x&gt;:PEAK:HIGHer  CALCulate:DPSA:MARKer&lt;x&gt;:PEAK:LEFT  CALCulate:DPSA:MARKer&lt;x&gt;:PEAK:LOWer  CALCulate:DPSA:MARKer&lt;x&gt;:PEAK:RIGHT  CALCulate:SPECtrum:MARKer&lt;x&gt;:PEAK:HIGHer  CALCulate:SPECtrum:MARKer&lt;x&gt;:PEAK:LEFT  CALCulate:SPECtrum:MARKer&lt;x&gt;:PEAK:LOWer  CALCulate:SPECtrum:MARKer&lt;x&gt;:PEAK:RIGHT </p>
<b>Arguments</b>	<p> &lt;value&gt; ::= &lt;NRf&gt; specifies the minimum threshold level for detecting peaks. The threshold value uses the current power units.  Range: -170 to +20 dBm. </p>
<b>Examples</b>	<p> CALCULATE:MARKER:PEAK:THRESHOLD -50 sets the minimum threshold level to -50 dBm. </p>

## CALCulate:SEARch:LIMit:FAIL? (Query Only)

Queries whether or not the current acquisition has a Spectrum mask violation.

<b>Conditions</b>	Measurement modes: Spectrum and DPX Spectrum
<b>Group</b>	Calculate commands
<b>Syntax</b>	CALCulate:SEARch:LIMit:FAIL?
<b>Arguments</b>	None
<b>Returns</b>	<boolean> where 0 represents a spectrum mask limit violation on trace 1, and 1 indicates no mask limit violations on trace 1.
<b>Examples</b>	CALCulate:SEARch:LIMit:FAIL? might return 0 to indicate that trace 1 violates the current spectrum mask or if mask testing is not enabled.

## CALCulate:SEARch:LIMit:MATCh:BEEP[:STATe]

Sets or queries whether or not to beep when a spectrum mask violation occurs.

<b>Conditions</b>	Measurement modes: Spectrum and DPX Spectrum
<b>Group</b>	Calculate commands
<b>Syntax</b>	CALCulate:SEARch:LIMit:MATCh:BEEP[:STATe] { OFF   ON   0   1 } CALCulate:SEARch:LIMit:MATCh:BEEP[:STATe]?
<b>Arguments</b>	ON or 1 enables the instrument to sound a beep when a mask test violation occurs. OFF or 0 disables the instrument from sounding a beep when a mask test violation occurs.
<b>Examples</b>	CALCULATE:SEARCH:LIMIT:MATCH:BEEP:STATE 1 sets the instrument to sound a beep when a mask test violation occurs. CALCULATE:SEARCH:LIMIT:MATCH:BEEP? might return a 0, indicating that the instrument sound beep on mask test violation parameter is disabled.

## CALCulate:SEARch:LIMit:MATCh:SACQuire[:STATe]

Sets or queries whether or not to pause acquisitions when a spectrum mask violation occurs.

<b>Conditions</b>	Measurement modes: Spectrum and DPX Spectrum
<b>Group</b>	Calculate commands
<b>Syntax</b>	CALCulate:SEARch:LIMit:MATCh:SACQuire[:STATe] { OFF   ON   0   1 } CALCulate:SEARch:LIMit:MATCh:SACQuire[:STATe]?
<b>Arguments</b>	ON or 1 sets the instrument to pause acquisition when a mask test violation occurs. OFF or 0 sets the instrument to continue measurement acquisition when a mask test violation occurs.

- Examples** `CALCULATE:SEARCH:LIMIT:MATCH:SACQUIRE:STATE 1` sets the instrument to pause acquisition when a mask test violation occurs.
- `CALCULATE:SEARCH:LIMIT:MATCH:SACQUIRE?` might return a 0, indicating that the instrument is set to continue measurement acquisition when a mask test violation occurs.

## **CALCulate:SEARCh:LIMit:MATCh:SPICture[:STATe]**

Sets or queries whether or not to export a screen image when a spectrum mask violation occurs.

- Conditions** Measurement modes: Spectrum and DPX Spectrum
- Group** Calculate commands
- Syntax** `CALCulate:SEARCh:LIMit:MATCh:SPICture[:STATe] { OFF | ON | 0 | 1 }`  
`CALCulate:SEARCh:LIMit:MATCh:SPICture[:STATe]?`
- Arguments** ON or 1 sets the instrument to automatically save a screen shot of spectrum mask violations when a mask test violation occurs.
- OFF or 0 sets the instrument to not automatically save a screen shot of the mask violations when a mask test violation occurs.
- Examples** `CALCULATE:SEARCH:LIMIT:MATCH:SPICTURE:STATE ON` sets the instrument to automatically save a screen shot of spectrum mask violations when a mask test violation occurs.
- `CALCULATE:SEARCH:LIMIT:MATCH:SPICTURE?` might return a 0, indicating that the instrument is set to continue measurement acquisition without saving a screen shot of the mask violations when a mask test violation occurs.

## **CALCulate:SEARCh:LIMit:MATCh:STRace[:STATe]**

Sets or queries whether or not to export the current measurement results when a spectrum mask violation occurs.

- Conditions** Measurement modes: Spectrum and DPX Spectrum
- Group** Calculate commands

**Syntax**    `CALCulate:SEARCH:LIMit:MATCH:STRace[:STATE] { OFF | ON | 0 | 1 }`  
`CALCulate:SEARCH:LIMit:MATCH:STRace[:STATE]?`

**Arguments**    ON or 1 sets the instrument to automatically export measurement results of spectrum mask violations to a file when a mask test violation occurs.

OFF or 0 sets the instrument to not export measurement results of spectrum mask violations to a file when a mask test violation occurs.

**Examples**    `CALCULATE:SEARCH:LIMIT:MATCH:STRACE:STATE ON` sets the instrument to export measurement results of spectrum mask violations to a file when a mask test violation occurs.

`CALCULATE:SEARCH:LIMIT:MATCH:STRACE?` might return a 1, indicating that the instrument is set to export measurement results of spectrum mask violations to a file when a mask test violation occurs.

## CALCulate:SEARch:LIMit:OPERation:MASK:LOAD

Loads a specified spectrum mask file.

**Conditions**    Measurement modes: Spectrum and DPX Spectrum

**Group**    Calculate commands

**Syntax**    `CALCulate:SEARch:LIMit:OPERation:MASK:LOAD <file_name>`

**Arguments**    `<file_name>::=<string>` specifies the path and file from which to load the spectrum mask file. You do not need to specify the mask test file extension.

When the specified spectrum mask file name does not include a path component, the file will be loaded from the current stored settings directory.

When the specified spectrum mask file name does include a path, the file will be loaded from the directory specified in the path.

The instrument ignores the command and generates an execution error if the specified spectrum mask file does not exist.

**Examples**    `CALCULATE:SEARCH:LIMIT:OPERATION:MASK:LOAD "Mask1"` loads the mask data from the *Mask1.hdm* file.



## CALCulate:SEARch:LIMit:STATE

Sets or queries the spectrum mask testing state.

This command is ignored and an error event generated if issued with a 1 or ON argument when no mask file is currently specified or the currently specified mask file does not exist.

<b>Conditions</b>	Measurement modes: Spectrum and DPX Spectrum
<b>Group</b>	Calculate commands
<b>Syntax</b>	CALCulate:SEARch:LIMit:STATE { OFF   ON   0   1 } CALCulate:SEARch:LIMit:STATE?
<b>Arguments</b>	ON or 1 enables Spectrum mask testing. OFF or 0 disables Spectrum mask testing.
<b>Examples</b>	CALCULATE:SEARCH:LIMIT:STATE 1 enables Spectrum mask testing. CALCULATE:SEARCH:LIMIT:STATE? might return a 0, indicating that Spectrum mask testing is disabled.

## CALCulate:SPECTrum:MARKer<x>:MAXimum (No Query Form)

Moves the specified marker to the maximum peak on the spectrum trace. Valid marker <x> values are 0 through 6.

This command is ignored and an error event generated when the specified marker is not enabled, marker display is disabled, or the instrument is not in Spectrum mode.

<b>Conditions</b>	Measurement modes: Spectrum
<b>Group</b>	Calculate commands
<b>Syntax</b>	CALCulate:SPECTrum:MARKer<x>:MAXimum
<b>Arguments</b>	None

**Examples**     `CALCULATE:SPECTrum:MARKER3:MAXIMUM` moves Marker 3 (M3) to the highest peak on the spectrum trace.

## **CALCulate:SPECTrum:MARKer<x>:MODE (No Query Form)**

Sets or queries the specified marker to absolute or delta measurement mode (in relation to Marker 1). Valid marker <x> values are 1 through 6. Marker 1 is always absolute.

This command is ignored and an error event generated when the specified marker is not enabled, marker display is disabled, or the instrument is not in Spectrum mode.

**Conditions**     Measurement modes: Spectrum

**Group**            Calculate commands

**Syntax**          `CALCulate:SPECTrum:MARKer<x>:MODE { ABSolute | DELTA }`  
`CALCulate:SPECTrum:MARKer<x>:MODE?`

**Arguments**     `ABSolute` sets the specified marker to absolute measurement mode.  
`DELTA` sets the specified marker to delta measurement mode, in relation to Marker 1.

**Examples**        `CALCULATE:SPECTrum:MARKER4:MODE ABSolute` sets Marker 4 (M4) to measure the absolute value at the specified marker position.  
`CALCULATE:SPECTrum:MARKER3:MODE?` might return `DELT`, indicating that the specified marker is set to delta measurement mode.

## **CALCulate:SPECTrum:MARKer<x>:PEAK:HIGHer (No Query Form)**

Moves the specified marker to the next peak on the Spectrum trace that is higher than the current marker position and is above the current marker peak threshold. Valid marker <x> values are 0 through 6.

This command is ignored and an error event generated when the specified marker is not enabled, marker display is disabled, or the instrument is not in Spectrum mode.

**Conditions**     Measurement modes: Spectrum

---

<b>Group</b>	Calculate commands
<b>Syntax</b>	<code>CALCulate:SPECTrum:MARKer&lt;x&gt;:PEAK:HIGHer</code>
<b>Related Commands</b>	<a href="#">CALCulate:SPECTrum:MARKer&lt;x&gt;:PEAK:LOWer</a> <a href="#">CALCulate:MARKer:PEAK:THReshold</a>
<b>Arguments</b>	None
<b>Examples</b>	<code>CALCULATE:SPECTrum:MARKER2:PEAK:HIGHER</code> moves Marker 2 (M2) to the next peak higher in amplitude on the Spectrum trace.

## **CALCulate:SPECTrum:MARKer<x>:PEAK:LEFT (No Query Form)**

Moves the specified marker to the next peak on the Spectrum trace that is to the left of the current marker position and is above the current marker peak threshold. Valid marker <x> values are 0 through 6.

This command is ignored and an error event generated when the specified marker is not enabled, marker display is disabled, or the instrument is not in Spectrum mode.

<b>Conditions</b>	Measurement modes: Spectrum
<b>Group</b>	Calculate commands
<b>Syntax</b>	<code>CALCulate:SPECTrum:MARKer&lt;x&gt;:PEAK:LEFT</code>
<b>Related Commands</b>	<a href="#">CALCulate:SPECTrum:MARKer&lt;x&gt;:PEAK:RIGHT</a> <a href="#">CALCulate:MARKer:PEAK:THReshold</a>
<b>Arguments</b>	None
<b>Examples</b>	<code>CALCULATE:SPECTrum:MARKER5:PEAK:LEFT</code> moves Marker 5 (M5) to the next peak to the left on the Spectrum trace.

## CALCulate:SPECTrum:MARKer<x>:PEAK:LOWer (No Query Form)

Moves the specified marker to the next peak on the Spectrum trace that is lower than the current marker position and is above the current marker peak threshold. Valid marker <x> values are 0 through 6.

This command is ignored and an error event generated when the specified marker is not enabled, marker display is disabled, or the instrument is not in Spectrum mode.

<b>Conditions</b>	Measurement modes: Spectrum
<b>Group</b>	Calculate commands
<b>Syntax</b>	CALCulate:SPECTrum:MARKer<x>:PEAK:LOWer
<b>Related Commands</b>	<a href="#">CALCulate:SPECTrum:MARKer&lt;x&gt;:PEAK:HIGHer</a> <a href="#">CALCulate:MARKer:PEAK:THReshold</a>
<b>Arguments</b>	None
<b>Examples</b>	CALCULATE:SPECTrum:MARKER2:PEAK:LOWer moves Marker 2 (M2) to the next peak lower in amplitude on the Spectrum trace.

## CALCulate:SPECTrum:MARKer<x>:PEAK:RIGHT (No Query Form)

Moves the specified marker to the next peak on the Spectrum trace that is to the right of the current marker position and is above the current marker peak threshold. Valid marker <x> values are 0 through 6.

This command is ignored and an error event generated when the specified marker is not enabled, marker display is disabled, or the instrument is not in Spectrum mode.

<b>Conditions</b>	Measurement modes: Spectrum
<b>Group</b>	Calculate commands
<b>Syntax</b>	CALCulate:SPECTrum:MARKer<x>:PEAK:RIGHT

<b>Related Commands</b>	<a href="#">CALCulate:SPECTrum:MARKer&lt;x&gt;:PEAK:LEFT</a> <a href="#">CALCulate:MARKer:PEAK:THReshold</a>
<b>Arguments</b>	None
<b>Examples</b>	CALCULATE:SPECTrum:MARKER2:PEAK:RIGHT moves Marker 2 (M2) to the next peak to the right on the Spectrum trace.

## CALCulate:SPECTrum:MARKer<x>[:SET]:CENTer (No Query Form)

Sets the measurement center frequency to the frequency of the specified Spectrum mode marker. Valid marker <x> values are 0 through 6.

This command is ignored and an error event generated when the specified marker is not enabled, marker display is disabled, or the instrument is not in Spectrum mode.

<b>Conditions</b>	Measurement modes: Spectrum
<b>Group</b>	Calculate commands
<b>Syntax</b>	CALCulate:SPECTrum:MARKer<x>[:SET]:CENTer
<b>Arguments</b>	None
<b>Examples</b>	CALCULATE:SPECTrum:MARKER1:SET:CENTer sets the center frequency to the frequency of Marker 1 (M1).

## CALCulate:SPECTrum:MARKer<x>:STATe

Sets or queries the enable/disable state of the specified mode marker. Valid marker <x> values are 0 through 6.

This command is ignored and an error event generated when the instrument is not in Spectrum mode.

<b>Conditions</b>	Measurement modes: Spectrum
<b>Group</b>	Calculate commands

**Syntax**     `CALCulate:SPECTrum:MARKer<x>:STATE { OFF | ON | 0 | 1 }`  
`CALCulate:SPECTrum:MARKer<x>:STATE?`

**Arguments**     ON or 1 enables the specified marker.  
OFF or 0 disables the specified marker.

**Examples**     `CALCulate:SPECTrum:MARKer5:STATE ON` enables Marker 5 (M5).  
`CALCulate:SPECTrum:MARKer2:STATE?` might return 0 to indicate that Marker 2 (M2) is not enabled.

## **CALCulate:SPECTrum:MARKer<x>:TRACe**

Sets or queries the trace on which the specified marker is placed in the Spectrum measurement. Valid marker <x> values are 1 through 6.

This command is ignored and an error event generated when the instrument is not in Spectrum measurement mode, the display or markers are currently disabled, the specified marker is not enabled, or the specified trace is not enabled.

**Conditions**     Measurement modes: Spectrum

**Group**     Calculate commands

**Syntax**     `CALCulate:SPECTrum:MARKer<x>:TRACe { TRACE1 | TRACE2 |`  
`TRACE3 | TRACE4 | TRACE5 | FOREground }`  
`CALCulate:SPECTrum:MARKer<x>:TRACe?`

**Arguments**     TRACE1 places the specified marker on Trace 1.  
TRACE2 places the specified marker on Trace 2.  
TRACE3 places the specified marker on Trace 3 (Ref A).  
TRACE4 places the specified marker on Trace 4 (Ref B).  
TRACE5 places the specified marker on Trace 5 (Math).  
FOREground places the specified marker on the front-most (selected) trace.

**Examples**     `CALCULATE:SPECTRUM:MARKER1:TRACE TRACE1` places Marker 1 (M1) on Trace 1.  
`CALCULATE:SPECTRUM:MARKER2:TRACE?` might return TRAC3, indicating that the marker is on the Ref A waveform.

## CALCulate:SPECTrum:MARKer<x>:X

Sets or queries the current frequency of the specified Spectrum mode marker on the spectrum trace.

When the specified maker is enabled and set to absolute marker mode, the return value of the query is a NRf type equal to the specified markers current frequency. When the specified maker is enabled and set to delta marker mode, the return value of the query is a NRf type equal to the difference between the specified markers frequency and the marker 1 frequency.

This command is ignored and an error event generated when the specified marker is not enabled, marker display is disabled, or the instrument is not in Spectrum mode.

**Conditions** Measurement modes: Spectrum

**Group** Calculate commands

**Syntax** CALCulate:SPECTrum:MARKer<x>:X <value>  
CALCulate:SPECTrum:MARKer<x>:X?

**Related Commands** [CALCulate:SPECTrum:MARKer<x>:Y?](#)

**Arguments** <value> ::= <NRf> specifies the horizontal (frequency) position of the marker. Range: allowable frequency range of the instrument.

**Examples** CALCULATE:SPECTRUM:MARKER3:X 800e6 places Marker 3 (M3) at 800 MHz on the spectrum trace.

## CALCulate:SPECTrum:MARKer<x>:Y? (Query Only)

Queries the vertical position (amplitude) of the selected marker on the spectrum trace.

When the specified marker is enabled and set to absolute marker mode, the return value of the query is a NRf value equal to the specified markers current amplitude. When the specified marker is enabled and set to delta marker mode, the return value of the query is a NRf value equal to the difference between the specified markers amplitude and the marker 1 amplitude.

This command is ignored and an error event generated when the specified marker is not enabled, marker display is disabled, or the instrument is not in Spectrum mode.

<b>Conditions</b>	Measurement modes: Spectrum
<b>Group</b>	Calculate commands
<b>Syntax</b>	CALCulate:SPECTrum:MARKer<x>:Y?
<b>Related Commands</b>	<a href="#">CALCulate:SPECTrum:MARKer&lt;x&gt;:X</a>
<b>Arguments</b>	None
<b>Returns</b>	<NRf> specifies the markers absolute or delta amplitude, in current power units, as specified by the UNIT:POWER command.
	<hr/> <i><b>NOTE.</b> When using log power units, the response units for the math trace is always in dB.</i> <hr/>
<b>Examples</b>	CALCULATE:SPECTRUM:MARKER1:Y? might return -34.28, indicating Marker 1 (M1) is at -34.28 dBm.

## CALibration:AUTO

Sets or queries the whether or not automatic normalizations should occur.

<b>Conditions</b>	Measurement modes: Spectrum and Amplitude vs. Time
<b>Group</b>	Calculate commands
<b>Syntax</b>	CALibration:AUTO { OFF   ON   0   1 } CALibration:AUTO?
<b>Arguments</b>	ON or 1 enables automatic normalizations. OFF or 0 disables automatic normalizations.
<b>Examples</b>	CALibration:AUTO ON enables automatic normalizations. CALibration:AUTO? might return 0 to indicate that automatic normalizations are disabled.



## CALibration:CORRection:EXTErnal:GAIN[:MAGNitude]

Sets or queries the external gain or loss value. It can be enabled or disabled using the [CALibration:CORRection:EXTErnal:GAIN:STATE](#) command.

<b>Conditions</b>	Measurement modes: All
<b>Group</b>	Calibration commands
<b>Syntax</b>	<code>CALibration:CORRection:EXTErnal:GAIN[:MAGNitude] &lt;value&gt;</code> <code>CALibration:CORRection:EXTErnal:GAIN[:MAGNitude]?</code>
<b>Arguments</b>	<code>&lt;value&gt; ::= &lt;NRF&gt;</code> specifies the external gain or loss value of the RF signal applied to the instrument. A positive value sets external gain; a negative value sets external loss. Range: -80 to +30 dB.
<b>Examples</b>	<code>CALIBRATION:CORRECTION:EXTERNAL:GAIN:MAGNITUDE -10</code> specifies an external loss of -10 dB.  <code>CALIBRATION:CORRECTION:EXTERNAL:GAIN:MAGNITUDE?</code> might return 20, indicating an external gain of 20 dB.

## CALibration:CORRection:EXTErnal:GAIN:STATE

Sets or queries the external signal gain/loss state mode. When enabled, the instrument applies the gain or loss setting as specified by the [CALibration:CORRection:EXTErnal:GAIN\[:MAGNitude\]](#) command.

<b>Conditions</b>	Measurement modes: All
<b>Group</b>	Calibration commands
<b>Syntax</b>	<code>CALibration:CORRection:EXTErnal:GAIN:STATE { OFF   ON   0   1 }</code> <code>CALibration:CORRection:EXTErnal:GAIN:STATE?</code>

**Related Commands**    [CALibration:CORRection:EXTErnal:GAIN\[:MAGNitude\]](#)

**Arguments** OFF or 0 disables the external gain/loss correction.  
ON or 1 enables the external gain/loss correction.

**Examples** CALIBRATION:CORRECTION:EXTERNAL:GAIN:STATE ON enables the external gain/loss corrections.

## \*CLS (No Query Form)

Clears the instrument status data structures. Refer to Section 3, *Status and Events*, for the register information.

The \*CLS command clears the following

- the Event Queue
- the Standard Event Status Register (SESR)
- the Status Byte Register (except the MAV bit)

**Conditions** Measurement modes: All

**Group** IEEE common commands

**Syntax** \*CLS

**Related Commands** [\\*ESE](#)  
[\\*ESR?](#)  
[\\*SRE](#)

**Arguments** None

**Examples** \*CLS clears the instrument status data structures.

## DISPlay:DPsA:MARKer:SHOW:STATe

Sets or queries the DPX mode enable/disable state for markers and marker readouts.

This command is ignored and an error event generated when the instrument is not in DPX Spectrum mode.

<b>Conditions</b>	Measurement modes: DPX Spectrum
<b>Group</b>	Display commands
<b>Syntax</b>	DISP <code>lay:DPSA:MARKer:SHOW:STATE</code> { OFF   ON   0   1 } DISP <code>lay:DPSA:MARKer:SHOW:STATE?</code>
<b>Arguments</b>	OFF or 0 disables markers and marker readouts in the DPX Spectrum measurement mode.  ON or 1 enables markers and marker readouts in the DPX Spectrum measurement mode.
<b>Examples</b>	DISP <code>LAY:DPSA:MARKER:SHOW:STATE ON</code> enables markers and marker readouts in the DPX Spectrum mode.

## DISP`lay:AVTime:MARKer:SHOW:STATE`

Sets or queries the Amplitude vs. Time mode enable/disable state for markers and marker readouts.

This command is ignored and an error event generated when the instrument is not in Amplitude vs. Time mode.

<b>Conditions</b>	Measurement modes: Amplitude vs. Time
<b>Group</b>	Display commands
<b>Syntax</b>	DISP <code>lay:AVTime:MARKer:SHOW:STATE</code> { OFF   ON   0   1 } DISP <code>lay:AVTime:MARKer:SHOW:STATE?</code>
<b>Arguments</b>	OFF or 0 disables markers and marker readouts in the Amplitude vs. Time measurement mode.  ON or 1 enables markers and marker readouts in the Amplitude vs. Time measurement mode.
<b>Examples</b>	DISP <code>LAY:AVTIME:MARKER:SHOW:STATE ON</code> enables markers and marker readouts in the Amplitude vs. Time measurement mode.

## DISPlay:AVTime:Y[:SCALE]:OFFSet

Sets or queries the vertical position (the value at the top edge of the vertical axis) of the Amplitude vs. Time display. The vertical position value uses the current power units.

This command is ignored and an error event generated when the instrument is not in the Amplitude vs. Time measurement mode or when using linear power units.

<b>Conditions</b>	Measurement modes: Amplitude vs. Time
<b>Group</b>	Display commands
<b>Syntax</b>	DISPlay:AVTime:Y[:SCALE]:OFFSet <value> DISPlay:AVTime:Y[:SCALE]:OFFSet?
<b>Arguments</b>	<value>::=<Nrf> specifies the vertical position. The vertical position value uses the current power units.
<b>Examples</b>	DISPLAY:SPECTRUM:Y:SCALE:OFFSET -12.5 sets the vertical position to -12.5 dBm.

## DISPlay:AVTime:Y[:SCALE]:PDIVision

Sets or queries the vertical scale (per division) of the Amplitude vs. Time measurement graph.

This command is ignored and an error event generated when the instrument is not in the Amplitude vs. Time measurement mode or when using linear power units.

<b>Conditions</b>	Measurement modes: Amplitude vs. Time
<b>Group</b>	Display commands
<b>Syntax</b>	DISPlay:AVTime:Y[:SCALE]:PDIVision <value> DISPlay:AVTime:Y[:SCALE]:PDIVision?
<b>Arguments</b>	<value>::=<Nrf> specifies the vertical scale (per division). Range: 1 to 20 dB/div.

**Examples**    `DISPLAY:SPECTRUM:Y:SCALE:PDIVISION 5` sets the vertical scale to 5 dB/div.

## DISPlay:GENeral:MEASview:NEW (No Query Form)

Sets a new measurement mode.

**Conditions**    Measurement modes: All

**Group**        Display commands

**Syntax**        `DISPlay:GENeral:MEASview:NEW { SPECTrum | DPSA | AVTime }`

**Arguments**    `SPECTrum` sets the instrument to Spectrum measurement mode.  
`DPSA` sets the instrument to DPX Spectrum measurement mode.  
`AVTime` sets the instrument to Amplitude vs. Time measurement mode.

**Examples**        `DISPLAY:GENERAL:MEASVIEW:NEW DPSA` sets the instrument to the DPX Spectrum measurement mode.

## DISPlay:GENeral:MEASview:SElect

Sets or queries the measurement mode.

**Conditions**    Measurement modes: All

**Group**        Display commands

**Syntax**        `DISPlay:GENeral:MEASview:SElect { SPECTrum | DPSA | AVTime }`  
`DISPlay:GENeral:MEASview:SElect?`

**Arguments**    `SPECTrum` sets the instrument to Spectrum measurement mode.  
`DPSA` sets the instrument to DPX Spectrum measurement mode.  
`AVTime` sets the instrument to Amplitude vs. Time measurement mode.

**Examples**        `DISPLAY:GENERAL:MEASVIEW:SELECT DPSA` sets the instrument to the DPX Spectrum measurement mode.

DISPLAY:GENERAL:MEASVIEW:SELECT? might return SPEC, indicating that the instrument is in the Spectrum measurement mode.

## DISPlay:SPECTrum:MARKer:SHOW:STATE

Sets or queries the Spectrum mode enable/disable state for markers and marker readouts.

This command is ignored and an error event generated when the instrument is not in the Spectrum measurement mode.

<b>Conditions</b>	Measurement modes: Spectrum
<b>Group</b>	Display commands
<b>Syntax</b>	DISPlay:SPECTrum:MARKer:SHOW:STATE { OFF   ON   0   1 } DISPlay:SPECTrum:MARKer:SHOW:STATE?
<b>Arguments</b>	OFF or 0 disables markers and marker readouts in the Spectrum measurement mode.  ON or 1 enables markers and marker readouts in the Spectrum measurement mode.
<b>Examples</b>	DISPlay:SPECTrum:MARKer:SHOW:STATE ON enables markers and marker readouts in the Spectrum mode.

## DISPlay:SPECTrum:Y[:SCALE]:OFFSet

Sets or queries the vertical position (the value at the top edge of the vertical axis) of the Spectrum display. The vertical position value uses the current power units.

This command is ignored and an error event generated when the instrument is not in the Spectrum measurement mode or when using linear power units.

<b>Conditions</b>	Measurement modes: Spectrum
<b>Group</b>	Display commands
<b>Syntax</b>	DISPlay:SPECTrum:Y[:SCALE]:OFFSet <value> DISPlay:SPECTrum:Y[:SCALE]:OFFSet?

**Related Commands** [\[SENSe\]:POWer:UNITs](#)

**Arguments** `<value> ::= <NRf>` specifies the vertical position.  
The vertical position value uses the current power units.

**Examples** `DISPlay:SPECTrum:Y:SCALE:OFFSET -12.5` sets the vertical position to -12.5 dBm.

## DISPlay:SPECTrum:Y[:SCALE]:PDIVision

Sets or queries the vertical scale (per division) of the Spectrum measurement graph.

This command is ignored and an error event generated when the instrument is not in the Spectrum measurement mode or when using linear power units.

**Conditions** Measurement modes: Spectrum

**Group** Display commands

**Syntax** `DISPlay:SPECTrum:Y[:SCALE]:PDIVision <value>`  
`DISPlay:SPECTrum:Y[:SCALE]:PDIVision?`

**Arguments** `<value> ::= <NRf>` specifies the vertical scale (per division).  
Range: 1 to 20 dB/div.

**Examples** `DISPlay:SPECTrum:Y:SCALE:PDIVISION 5` sets the vertical scale to 5 dB/div.

## \*ESE

Sets or queries the bits in the Event Status Enable Register (ESER). The ESER prevents events from being reported to the Status Byte Register (STB). Refer to Section 3, *Status and Events*, for the register information.

**Conditions** Measurement modes: All

**Group** IEEE common commands

**Syntax** \*ESE <value>  
\*ESE?

**Related Commands** \*CLS  
\*ESR?  
\*SRE

**Arguments** <value>: :=<NR1> is a value in the range from 0 through 255.  
The binary bits of the ESER are set according to this value.

**Examples** \*ESE 145 sets the ESER to binary 10010001.  
\*ESE? might return the string \*ESE 184, showing that the ESER contains the binary value 10111000.

## \*ESR? (Query Only)

Returns the contents of the Standard Event Status Register (SESR). \*ESR? also clears the SESR (since reading the SESR clears it). Refer to Section 3, *Status and Events*, for the register information.

**Conditions** Measurement modes: All

**Group** IEEE common commands

**Syntax** \*ESR?

**Related Commands** \*CLS  
\*ESE  
\*SRE

**Arguments** None

**Returns** <NR1> representing the contents of the SESR by a 0 to 255 decimal number.

**Examples** \*ESR? might return the value 213, showing that the SESR contains binary 11010101.



## FETCh:AVTime:TRACe<x>? (Query Only)

Queries the current Amplitude vs. Time mode trace data for the specified trace. The valid range of trace<x> values is 1 through 2.

This command is ignored and an error event generated when the specified trace is not currently enabled or the instrument is not in the Amplitude vs. Time measurement mode.

**Conditions** Measurement modes: Amplitude vs. Time

**Group** Fetch commands

**Syntax** FETCh:AVTime:TRACe<x>?

**Arguments** None

**Returns** When the results data format is set to ASCII, the 500 amplitude points are returned as 500 comma-separated NR2 values. When the results data format is set to binary, the 500 amplitude points are returned in an arbitrary block format as 4-byte little endian floating point values as follows:

```
#<num_digit><num_byte><data(1)<data(2)>...<data(500)>
```

Where:

<num\_digit> is the number of digits in <num\_byte>. This value is always 4.

<num\_byte> is the number of bytes of data that follow.

<data(n)> is the amplitude (in current power units) of the trace for point #n, 4-byte little endian floating-point format, as specified in IEEE 488.2.

---

**NOTE.** *When the trace is in min/max hold mode, waveform points for both the min and max waveforms are returned, resulting in a total of 1000 amplitude points.*

---

**Examples** FETCh:AVTime:TRACe2? might return #42004xxxx... for the Amplitude vs. Time waveform trace 2 data.

## FETCh:DPSA:BITMap? (Query Only)

Query the current DPX Spectrum mode hit count information for each cell of the bitmap data.

This command is ignored and an error event generated when the instrument is not in the DPX Spectrum measurement mode.

**Conditions** Measurement modes: DPX Spectrum

**Group** Fetch commands

**Syntax** FETCh:DPSA:BITMap?

**Arguments** None

**Returns** <arbitrary block> containing hit count information for each cell of the DPX bitmap data, based on the current DPX bitmap intensity and dot persistence settings. The format of the query response is a matrix of cells consisting of 151 rows by 365 columns, for a total of 55115 bytes, with the following characteristics:

- The first byte in the response is the upper left hand corner cell of the displayed DPX Spectrum bitmap. The first row of data (the first 365 bytes) in the response is the top row of cells of the displayed DPX Spectrum bitmap.
- The last byte in the response is the lower right hand corner cell of the displayed DPX Spectrum bitmap. The last row of data (the last 365 bytes) in the response is the bottom row of cells of the displayed DPX Spectrum bitmap.
- Each byte in the data block indicates what percentage of time that particular cell was "hit" by the input signal. The following list indicates the hit percentage values:

Cell value	Percent hit range
15	93.34 to 100.00
14	86.68 to 93.33
13	80.01 to 86.67
12	73.34 to 80.00
11	66.68 to 73.33
10	60.01 to 66.67
9	53.34 to 60.00
8	46.68 to 53.33
7	40.01 to 46.68
6	33.34 to 40.00
5	26.68 to 33.33
4	20.01 to 26.67
3	6.68 to 13.33

Cell value	Percent hit range
2	6.68 to 13.33
1	0.01 to 6.67
0	0.0 0(Never hit)

**Examples** `FETCH:DPSA:BITMap?` might return `#555115...` for the hit count information of each cell of the bitmap data.

## FETCH:DPSA:TRACe1? (Query Only)

Query the current DPX Spectrum mode trace1 data.

This command is ignored and an error event generated when the instrument is not in the DPX Spectrum measurement mode.

**Conditions** Measurement modes: DPX Spectrum

**Group** Fetch commands

**Syntax** `FETCH:DPSA:TRACe1?`

**Related Commands** [FORMat:\[DATA\]](#)

**Arguments** None

**Returns** When the results data format is set to ASCII, the 365 amplitude points are returned as 365 comma-separated NR2 values. When the results data format is set to binary, the 365 amplitude points are returned in an arbitrary block format as 4-byte little endian floating point values as follows:

```
#<num_digit><num_byte><data(1)<data(2)>...<data(365)>
```

Where:

`<num_digit>` is the number of digits in `<num_byte>`. This value is always 4.  
`<num_byte>` is the number of bytes of data that follow. This value is always 1460.  
`<data(n)>` is the amplitude (in current power units) of the trace for point #n, 4-byte little endian floating-point format as specified in IEEE 488.2.

**Examples** `FETCH:DPSA:TRACe1?` might return `#41460xxxx...` for the DPX Spectrum waveform data.

## FETCh:SPECTrum:TRACe<x>? (Query Only)

Queries the current Spectrum mode trace data for the specified trace. The valid range of trace<x> values is 1 through 5.

This command is ignored and an error event generated when the specified trace is not currently enabled or the instrument is not in the Spectrum measurement mode.

<b>Conditions</b>	Measurement modes: Spectrum
<b>Group</b>	Fetch commands
<b>Syntax</b>	FETCh:SPECTrum:TRACe<x>?
<b>Related Commands</b>	<a href="#">FORMat:[DATA]</a>
<b>Arguments</b>	None
<b>Returns</b>	<p>When the results data format is set to ASCII, the 501 amplitude points are returned as 501 comma-separated NR2 values. When the results data format is set to binary, the 501 amplitude points are returned in an arbitrary block format as 4-byte little endian floating point values as follows:</p> <pre>#&lt;num_digit&gt;&lt;num_byte&gt;&lt;data(1)&lt;data(2)&gt;...&lt;data(501)&gt;</pre> <p>Where:</p> <p>&lt;num_digit&gt; is the number of digits in &lt;num_byte&gt;. This value is always 4.</p> <p>&lt;num_byte&gt; is the number of bytes of data that follow.</p> <p>&lt;data(n)&gt; is the amplitude (in current power units) of the trace for point #n, 4-byte little endian floating-point format as specified in IEEE 488.2.</p> <hr/> <p><b>NOTE.</b> <i>When the trace is in min/max hold mode, waveform points for both the min and max waveforms are returned, resulting in a total of 1002 amplitude points.</i></p> <hr/>
<b>Examples</b>	FETCh:SPECTrum:TRACe3? might return #42004xxxx... for the Spectrum waveform trace 3 data.

## FORMat:[DATA]

Sets or queries whether the following commands/queries will use binary or ASCII formats for parameters and/or query responses:

FETCh:DPSA:TRACe1?, FETCh:SPECTrum:TRACe<x>?,  
MMEMory:STORe:RESults

**Conditions** Measurement modes: All

**Group** Format commands

**Syntax** FORMat:[DATA] {ASCIi | BINary }  
FORMat:[DATA]?

**Related Commands** [FETCh:DPSA:TRACe1?](#)  
[FETCh:AVTime:TRACe<x>?](#)  
[MMEMory:STORe:IQ:CSV](#)

**Arguments** ASCIi sets the format type to ASCII.  
BINary sets the format type to binary.

**Examples** FORMat:DATA ASCII sets the format type to ASCII.  
FORMat:DATA? might return BIN, indicating that the format type is binary.

## FORMat:[DATA]:LOGGing

Sets or queries the format of the measurement result data logging file (ASCII or binary).

**Conditions** Measurement modes: All

**Group** Format commands

**Syntax** FORMat:[DATA]:LOGGing {ASCIi | BINary }  
FORMat:[DATA]:LOGGing?

**Related Commands** [SYSTem:LOGGing:GPS](#)  
[SYSTem:LOGGing:GPS:FILE\[:NAME\]](#)

SYSTem:LOGGing:RESults  
 SYSTem:LOGGing:RESults:FILE[:NAME]

**Arguments**    ASCi i sets the data logging file format to ASCII.  
                   BINary sets the data logging file format to binary.

**Examples**     FORMAT:DATA:LOGGING ASCII sets the measurement data logging output file format to ASCII.  
                   FORMAT:LOGGING? might return BIN, indicating that the measurement data logging output file format is binary.

## \*IDN? (Query Only)

Returns the instrument identification code.

**Conditions**    Measurement modes: All

**Group**         IEEE common commands

**Syntax**        \*IDN?

**Arguments**    None

**Returns**        The instrument identification code in the following format  
                   TEKTRONIX,<instrument\_name>,<serial\_number>,<firmware\_version>

Where:

TEKTRONIX indicates that the manufacturer is Tektronix.  
 <instrument\_name> is the instrument name (SA2500 or H500).  
 <serial\_number> is the serial number.  
 <firmware\_version> is the software version of the application.

**Examples**     \*IDN? might return the response TEKTRONIX,SA2500,B0101533,FV2.063.

## INITiate:CONTinuous

Sets or queries the instrument measurement acquisition mode (single or continuous).

<b>Conditions</b>	Measurement modes: All
<b>Group</b>	Initiate commands
<b>Syntax</b>	INITiate:CONTinuous { OFF   ON   0   1 } INITiate:CONTinuous?
<b>Related Commands</b>	<a href="#">INITiate[:IMMediate]</a>
<b>Arguments</b>	OFF or 0 places the instrument in the single acquisition mode. ON or 1 places the instrument in the continuous acquisition mode.
<b>Examples</b>	INITIATE:CONTINUOUS ON places the instrument in the continuous acquisition mode.

## INITiate[:IMMediate] (No Query Form)

Starts an input signal acquisition.

---

**NOTE.** *This is an overlapped command that does not finish executing before the next command starts executing. Use the \*OPC(?) and \*WAI commands to synchronize all pending operations to the execution of this command.*

---

<b>Conditions</b>	Measurement modes: All
<b>Group</b>	Initiate commands
<b>Syntax</b>	INITiate[:IMMediate]
<b>Related Commands</b>	<a href="#">*OPC</a> <a href="#">*TRG</a> <a href="#">*WAI</a> <a href="#">INITiate:CONTinuous</a>
<b>Arguments</b>	None
<b>Examples</b>	INITIATE:IMMEDIATE starts an input signal acquisition.

## INPut:ALEVel (No Query Form)

Performs an auto-level operation.

<b>Conditions</b>	Measurement modes: All
<b>Group</b>	Input commands
<b>Syntax</b>	INPut:ALEVel
<b>Arguments</b>	None
<b>Examples</b>	INPut:ALEVel performs an auto-level operation.

## INPut:RLEVel

Sets or queries the input reference level.

<b>Conditions</b>	Measurement modes: All
<b>Group</b>	Input commands
<b>Syntax</b>	INPut:RLEVel <value> INPut:RLEVel?
<b>Arguments</b>	<value> ::= <Nrf> specifies the reference level value. The reference level value uses the current power units.
<b>Examples</b>	INPut:RLEVel 10 sets the reference level to 10.

## INPut[:RF]:ATTenuation

Sets or queries the input attenuation value.

<b>Conditions</b>	Measurement modes: All
-------------------	------------------------



---

<b>Group</b>	Input commands
<b>Syntax</b>	<code>INPut[:RF]:ATTenuation &lt;value&gt;</code> <code>INPut[:RF]:ATTenuation?</code>
<b>Arguments</b>	<code>&lt;value&gt; ::= &lt;NR1&gt;</code> specifies the input attenuation. Range: 0 to 50 dB in 5 dB steps.
<b>Examples</b>	<code>INPUT:RF:ATTENUATION 20</code> sets the input attenuation to 20 dB.

## INPut[:RF]:GAIN:STATE

Sets or queries the input preamp state.

The preamp can only be enabled when the input attenuation is 15 dB or less.

<b>Conditions</b>	Measurement modes: All
<b>Group</b>	Input commands
<b>Syntax</b>	<code>INPut[:RF]:GAIN:STATE { OFF   ON   0   1 }</code> <code>INPut[:RF]:GAIN:STATE?</code>
<b>Arguments</b>	OFF or 0 disables the internal pre-amp. ON or 1 enables the internal pre-amp.
<b>Examples</b>	<code>INPUT:RF:GAIN:STATE ON</code> enables the internal pre-amp.

## MMEMory:APPData:PREFix

Sets or queries the prefix to use for automatically generated filenames.

<b>Conditions</b>	Measurement modes: All
<b>Group</b>	Mass memory commands

<b>Syntax</b>	<code>MMEemory:APPData:PREFIX &lt;prefix&gt;</code> <code>MMEemory:APPData:PREFIX?</code>
<b>Related Commands</b>	<a href="#">MMEemory:STORE:IQ</a> <a href="#">MMEemory:STORE:IQ:CSV</a> <a href="#">MMEemory:STORE:IQ:MAT</a> <a href="#">MMEemory:STORE:RESULTS</a> <a href="#">MMEemory:STORE:SCREEN</a> <a href="#">MMEemory:STORE:STATE</a>
<b>Arguments</b>	<code>&lt;prefix&gt;::&lt;string&gt;</code> specifies the prefix for automatically generated filenames. An empty string specifies that no prefix should be used.
<b>Examples</b>	<code>MMEemory:APPData:RESULTS "\Data\MyResults"</code> sets the default measurement result directory to <code>\Data\MyResults</code> .

## MMEemory:APPData:RESULTS

Sets or queries the default directory location for measurement results. This directory is used when using automatically named results files or when a path is not specified for the measurement result file.

<b>Conditions</b>	Measurement modes: All
<b>Group</b>	Mass memory commands
<b>Syntax</b>	<code>MMEemory:APPData:RESULTS &lt;file_name&gt;</code> <code>MMEemory:APPData:RESULTS?</code>
<b>Related Commands</b>	<a href="#">MMEemory:APPData:RESULTS:INIT</a> <a href="#">MMEemory:STORE:IQ</a> <a href="#">MMEemory:STORE:IQ:CSV</a> <a href="#">MMEemory:STORE:IQ:MAT</a> <a href="#">MMEemory:STORE:RESULTS</a> <a href="#">MMEemory:STORE:SCREEN</a>
<b>Arguments</b>	<code>&lt;file_name&gt;::&lt;string&gt;</code> specifies the full path name for the measurement results directory.

**Examples** `MMEMory:APPData:RESuLts "\Data\MyResults"` sets the default measurement result directory to `\Data\MyResults`.

## **MMEMory:APPData:RESuLts:DEFault:EXPort:FORMat**

Sets or queries the default measurement results ASCII export format.

**Conditions** Measurement modes: All

**Group** Mass memory commands

**Syntax** `MMEMory:APPData:RESuLts:DEFault:EXPort:FORMat { CSV | TEXT }`  
`MMEMory:APPData:RESuLts:DEFault:EXPort:FORMat?`

**Related Commands** [MMEMory:STORe:RESuLts](#)

**Arguments** CSV specifies comma-separated ASCII format.  
TEXT specifies tab-separated ASCII format.

**Examples** `MMEMory:APPData:RESuLts:DEFault:EXPort:FORMat CSV` sets the default measurement results ASCII export format to comma-separated ASCII format.

## **MMEMory:APPData:RESuLts:DEFault:SCReen:FORMat**

Sets or queries the default screen image export format.

**Conditions** Measurement modes: All

**Group** Mass memory commands

**Syntax** `MMEMory:APPData:RESuLts:DEFault:SCReen:FORMat { JPG | BMP | PNG }`  
`MMEMory:APPData:RESuLts:DEFault:SCReen:FORMat?`

**Related Commands** [MMEMory:STORe:SCReen](#)

- Arguments**   JPG specifies a screen image export format of JPEG.  
BMP specifies a screen image format of Bitmap.  
PNG specifies a screen image format of PNG (not supported on PC desktop versions of the H500/SA2500 applications).
- Examples**   **MMEMory:APPData:RESuLts:DEFauLt:EXPort:FORMat** BMP sets the default screen image export format to Bitmap.

## **MMEMory:APPData:RESuLts:DELeTe (No Query Form)**

Deletes the specified file from the current measurement results directory.  
The command is ignored and generates an execution error if the specified file does not exist in the current measurement results directory.

- Conditions**   Measurement modes: All
- Group**        Mass memory commands
- Syntax**       **MMEMory:APPData:RESuLts:DELeTe** <file\_name>
- Arguments**   <file\_name>::<string> deletes the specified file name in the current measurement results directory to delete.
- Examples**    **MMEMory:APPData:RESuLts:DELeTe** "spect00001.txt" deletes the file spect00001.txt from the current measurement results directory.

## **MMEMory:APPData:RESuLts:EXISts? (Query Only)**

Queries to see if a specified file exists in the current measurement results directory.

- Conditions**   Measurement modes: All
- Group**        Mass memory commands
- Syntax**       **MMEMory:APPData:RESuLts:EXISts?** <file\_name>

<b>Arguments</b>	<file_name>::<string> specifies the file name in the current measurement results directory for which to check.
<b>Returns</b>	<Boolean> where 0 indicates the file does not exist, and 1 indicates it does exist.
<b>Examples</b>	<code>MMEemory:APPData:RESuLts:EXISTS?</code> “spect00002.csv” would return 1 if the file spect00002.csv was present in the current measurement results directory.

## MMEemory:APPData:RESuLts:INIT (No Query Form)

Sets the measurement results directory to the factory default value.

<b>Conditions</b>	Measurement modes: All
<b>Group</b>	Mass memory commands
<b>Syntax</b>	<code>MMEemory:APPData:RESuLts:INIT</code>
<b>Arguments</b>	None.
<b>Examples</b>	<code>MMEemory:APPData:RESuLts:INIT</code> sets the measurement results directory to the factory default value.

## MMEemory:APPData:SETTings

Sets or queries the default directory location for stored settings. This is the directory that is used when using automatically named settings files or when a path is not specified for the settings file.

<b>Conditions</b>	Measurement modes: All
<b>Group</b>	Mass memory commands
<b>Syntax</b>	<code>MMEemory:APPData:SETTings &lt;file_name&gt;</code> <code>MMEemory:APPData:SETTings?</code>

**Related Commands** [MMEemory:APPData:SETTings:INIT](#)

### MMEMory:STORe:STATe

**Arguments** <file\_name>::<string> specifies the full path name of the stored settings directory.

**Examples** MMEMory:APPData:SETTings "\Data\MySettings" sets the default stored settings directory to \Data\MySettings.

### MMEMory:APPData:SETTings:DELeTe (No Query Form)

Deletes a specified file from the current stored settings directory.

The command is ignored and generates an execution error if the specified file does not exist in the current stored settings directory.

**Conditions** Measurement modes: All

**Group** Mass memory commands

**Syntax** MMEMory:APPData:SETTings:DELeTe <file\_name>

**Arguments** <file\_name>::<string> specifies the file name in the current stored settings directory to delete.

**Examples** MMEMory:APPData:SETTings:DELeTe "00001.sav" deletes the file 00001.sav from the current stored settings directory.

### MMEMory:APPData:SETTings:EXISts? (Query Only)

Queries to see if a specified file exists in the current stored settings directory.

**Conditions** Measurement modes: All

**Group** Mass memory commands

**Syntax** MMEMory:APPData:SETTings:EXISts? <file\_name>

---

<b>Arguments</b>	<file_name>::<string> specifies the file name in the current stored settings directory for which to check.
<b>Returns</b>	<Boolean> where 0 indicates the file does not exist, and 1 indicates it does exist.
<b>Examples</b>	<code>MMEemory:APPData:SETTings:EXISTS?</code> "mysetup.sav" returns 1 if the file mysetup.sav is present in the current stored settings directory.

## MMEemory:APPData:SETTings:INIT (No Query Form)

Sets the stored settings directory to the factory default value.

<b>Conditions</b>	Measurement modes: All
<b>Group</b>	Mass memory commands
<b>Syntax</b>	<code>MMEemory:APPData:SETTings:INIT</code>
<b>Arguments</b>	None
<b>Examples</b>	<code>MMEemory:APPData:SETTings:INIT</code> sets the stored settings directory to the factory default value.

## MMEemory:APPData:USERsettings

Set or queries the location of the default directory for user settings. This is the directory that is used when saving automatically named user settings files or when a path is not specified for the user settings file.

<b>Conditions</b>	Measurement modes: All
<b>Group</b>	Mass memory commands
<b>Syntax</b>	<code>MMEemory:APPData:USERsettings &lt;file_name&gt;</code> <code>MMEemory:APPData:USERsettings?</code>
<b>Arguments</b>	<file_name>::<string> specifies the full path name for the user settings directory.

**Examples**    `MMEemory:APPData:USERsettings "\Data\MySettings"` sets the default user settings directory to `\Data\MySettings`.

## **MMEemory:APPData:USERsettings:DElete (No Query Form)**

Deletes the specified file from the current user settings directory.

The command is ignored and generates an execution error if the specified file does not exist in the current user settings directory.

**Conditions**    Measurement modes: All

**Group**        Mass memory commands

**Syntax**       `MMEemory:APPData:USERsettings:DElete <file_name>`

**Arguments**    `<file_name>::<string>` specifies the file name in the current user settings directory to delete.

**Examples**    `MMEemory:APPData:USERsettings:DElete "mycablecorr.csv"` deletes the file `mycablecorr.csv` from the current user settings directory.

## **MMEemory:APPData:USERsettings:EXISTS? (Query Only)**

Queries to see if a specified file exists in the current user settings directory.

**Conditions**    Measurement modes: All

**Group**        Mass memory commands

**Syntax**       `MMEemory:APPData:USERsettings:EXISTS? <file_name>`

**Arguments**    `<file_name>::<string>` specifies the file name in the current user settings directory to check for.

**Returns**       `<Boolean>` where 0 indicates the file does not exist, and 1 indicates it does exist.



**Examples** `MMEemory:APPData:USERsettings:EXISTS?` “mycablecorr.csv” returns 1 if the file mycablecorr.csv is present in the current user settings directory.

## **MMEemory:APPData:USERsettings:INIT (No Query Form)**

Sets the user settings directory to its factory default value.

**Conditions** Measurement modes: All

**Group** Mass memory commands

**Syntax** `MMEemory:APPData:USERsettings:INIT`

**Arguments** None

**Examples** `MMEemory:APPData:USERsettings:INIT` sets the user settings directory to its factory default value.

## **MMEemory:DELEte (No Query Form)**

Deletes the specified file from the specified path location.

The command is ignored and generates an execution error if the specified file does not exist in the specified path location.

**Conditions** Measurement modes: All

**Group** Mass memory commands

**Syntax** `MMEemory:DELEte <file_name>`

**Arguments** `<file_name>::<string>` specifies the path and file name to delete.

**Examples** `MMEemory:DELEte “\temp\mytempsetup.sav”` deletes the file mytempsetup.sav from the \temp directory.

## MMEMory:EXISts? (Query Only)

Queries to see if a specified file exists at the specified path.

<b>Conditions</b>	Measurement modes: All
<b>Group</b>	Mass memory commands
<b>Syntax</b>	MMEMory:EXISts? <file_name>
<b>Arguments</b>	<file_name>::<string> specifies the path and file name for which to check.
<b>Returns</b>	<Boolean> where 0 indicates the file does not exist, and 1 indicates it does exist.
<b>Examples</b>	MMEMory:EXISts? “\temp\mytempsetup.sav” returns 1 if the file mytempsetup.sav is present in the \temp directory.

## MMEMory:LOAD:RESuLts (No Query Form)

Loads a binary format stored measurement result file.

This command is ignored and an error event generated when the specified measurement result file does not exist or is not a valid binary format measurement result file.

---

**NOTE.** Loading a binary stored measurement result file has a side effect of setting the current instrument measurement mode to that of the result being recalled.

---

<b>Conditions</b>	Measurement modes: All
<b>Group</b>	Mass memory commands
<b>Syntax</b>	MMEMory:LOAD:RESuLts <file_name>
<b>Arguments</b>	<file_name>::<string> specifies the path and file name from which to load binary format stored measurement results data. When the specified file does not include a path component, the file is loaded from the current measurement results

directory. When a path is specified, the current measurement results directory is set to that path.

You must enter a file extension as part of the file name. The following table lists valid measurement results file extensions.

Measurement	File extension
Amplitude vs. Time	.savt
Spectrum	.ssp
DPX Spectrum	.sdpx

**Examples** `MMEMORY:LOAD:RESULTS "meas1.ssp"` loads and displays the binary format measurement results data from the *meas1.ssp* file and sets the current measurement mode to Spectrum.

## MMEMory:LOAD:STATE (No Query Form)

Loads instrument settings data from a specified file and configures the instrument with the new settings data.

This command is ignored and an error event generated when the specified settings file does not exist or is not a settings file.

**Conditions** Measurement modes: All

**Group** Mass memory commands

**Syntax** `MMEMory:LOAD:STATE <file_name>`

**Arguments** `<file_name>::=<string>` specifies the path and file name from which to load the instrument settings data. When the specified file does not include a path component, the file is loaded from the current saved settings directory. When a path is specified, the current saved settings directory is set to that path. The file extension is `.sav`. You can omit the extension.

**Examples** `MMEMORY:LOAD:STATE "Setup1"` loads and configures the instrument settings from the *Setup1.sav* file of the current saved settings directory.

## MMEMory:SPECTrum:LOAD:TRACe<x> (No Query Form)

Load the specified waveform trace from the specified measurement result file into either the RefA (Trace 3) or RefB (Trace 4) trace. Valid trace<x> values are 3 and 4.

This command is ignored and an error event generated when the file does not exist, the instrument is not in the Spectrum measurement mode, the destination trace is not enabled, or the measurement result file does not contain the specified source trace.

**Conditions** Measurement modes: Spectrum

**Group** Mass memory commands

**Syntax** MMEMory:SPECTrum:LOAD:TRACe<x> {TRACe1 | TRACe2 | TRACe3 | TRACe4 | TRACe5}, <file\_name>

**Arguments** TRACe1 specifies to load Trace 1 waveform data from the file.

TRACe2 specifies to load Trace 2 waveform data from the file.

TRACe3 specifies to load Trace 3 waveform data from the file.

TRACe4 specifies to load Trace 4 waveform data from the file.

TRACe5 specifies to load Trace 5 waveform data from the file.

<file\_name> ::= <string> specifies the measurement results file from which to load the trace data. When the string does not include a path component, the file is loaded from the current measurement results directory. When a path is specified, the current measurement results directory is set to that path.

You must enter a file extension as part of the file name. See [MMEMory:LOAD:RESults](#) for a table of valid measurement results file extensions.

**Examples** MMEMORY:SPECTRUM:LOAD:TRACE3 TRACE1, "Meas23.ssp" loads trace 1 waveform data from the *meas23.ssp*. file into Trace 3 (RefA) and displays the waveform.

## MMEMory:STORe:IQ (No Query Form)

Saves the time-domain IQ data for the currently displayed acquisition to a specified file in IQT format.

The IQT format is a binary format for use with the Tektronix RSAVu application. See the RSAVu documentation for more information.

**Conditions** Measurement modes: Amplitude vs. Time

**Group** Mass memory commands

**Syntax** `MMEMemory:STORE:IQ [<file_name>]`

**Related Commands** [MMEMemory:APPData:PREFIX](#)  
[MMEMemory:APPData:RESULTS](#)  
[MMEMemory:STORE:IQ:CSV](#)  
[MMEMemory:STORE:IQ:MAT](#)

**Arguments** The optional `<file_name>::=<string>` specifies the path and file name in which to store the measurement results. When the string does not include a path component, the file is saved to the current measurement results directory. When a path is specified, the current measurement results directory is set to that path.

When the `<file_name>` argument is omitted, the time-domain IQ data is automatically saved in the current measurement results directory with a unique file name.

The file extension is `.iqt`. You can omit the extension. Any specified filename extension is discarded and replaced with `iqt`.

**Examples** `MMEMemory:STORE:IQ "RESULT1.iqt"` stores the current IQ data to the `RESULT1.iqt` file as an IQT format file in the current measurement results directory.

## MMEMemory:STORE:IQ:CSV (No Query Form)

Saves the time-domain IQ data for the currently displayed acquisition to a specified file in CSV format.

The CSV format uses the first four rows to list the sampling frequency, number of samples, data/time of export, and the center frequency. The remaining rows in the CSV file are the pairs of IQ data.

**Conditions** Measurement modes: Amplitude vs. Time

**Group** Mass memory commands

**Syntax** `MMEMemory:STORE:IQ:CSV [<file_name>]`

**Related Commands** [MMEMemory:APPData:PREFIX](#)  
[MMEMemory:APPData:RESULTS](#)  
[MMEMemory:STORE:IQ](#)  
[MMEMemory:STORE:IQ:MAT](#)

**Arguments** The optional `<file_name>::=<string>` specifies the path and file name in which to store the measurement results. When the string does not include a path component, the file is saved to the current measurement results directory. When a path is specified, the current measurement results directory is set to that path.

When the `<file_name>` argument is omitted, the time-domain IQ data is automatically saved in the current measurement results directory with a unique file name.

The file extension is `.csv`. You can omit the extension. Any specified filename extension is discarded and replaced with `csv`.

**Examples** `MMEMemory:STORE:IQ:CSV "RESULT1.csv"` stores the current IQ data to the `RESULT1.csv` file as an ASCII comma-separated format file in the current measurement results directory.

## MMEMemory:STORE:IQ:MAT (No Query Form)

Saves the time-domain IQ data for the currently displayed acquisition to a specified file in Matlab format.

The Matlab format includes the following Matlab variables:

- `<InputCenter>` - center frequency
- `<InputZoom>` - always 1
- `<XDelta>` - 1/sample rate
- `<Y>` - pairs of IQ data

**Conditions** Measurement modes: Amplitude vs. Time

**Group** Mass memory commands

**Syntax** `MMEMemory:STORE:IQ:MAT [<file_name>]`

<b>Related Commands</b>	<a href="#">MMEMory:APPData:PREFix</a> <a href="#">MMEMory:APPData:RESults</a> <a href="#">MMEMory:STORE:IQ</a> <a href="#">MMEMory:STORE:IQ:CSV</a>
<b>Arguments</b>	<p>The optional <code>&lt;file_name&gt;::=&lt;string&gt;</code> specifies the path and file name in which to store the measurement results. When the string does not include a path component, the file is saved to the current measurement results directory. When a path is specified, the current measurement results directory is set to that path.</p> <p>When the <code>&lt;file_name&gt;</code> argument is omitted, the time-domain IQ data is automatically saved in the current measurement results directory with a unique file name.</p> <p>The file extension is <code>.mat</code>. You can omit the extension. Any specified filename extension is discarded and replaced with <code>mat</code>.</p>
<b>Examples</b>	<p><code>MMEMORY:STORE:IQ:MAT "RESULT1.mat"</code> stores the current IQ data to the <code>RESULT1.mat</code> file as an MatLab format file in the current measurement results directory.</p>

## MMEMory:STORE:RESults (No Query Form)

Stores the current measurement results to a specified file in either binary or ASCII format, as last set by the [FORMat:\[DATA\]](#) command.

This command is ignored and an error event generated when a specified file directory component does not exist or the specified measurement result file name already exists.

<b>Conditions</b>	Measurement modes: All
<b>Group</b>	Mass memory commands
<b>Syntax</b>	<code>MMEMory:STORE:RESults [&lt;file_name&gt;]</code>

<b>Related Commands</b>	<a href="#">FORMat:[DATA]</a> <a href="#">MMEMory:APPData:PREFix</a> <a href="#">MMEMory:APPData:RESults</a> <a href="#">MMEMory:APPData:RESults:DEFault:EXPort:FORMat</a> <a href="#">MMEMory:LOAD:RESults</a>
-------------------------	---

**Arguments** The optional `<file_name>::=<string>` specifies the path and file name in which to store the measurement results. When the string does not include a path component, the file is saved to the current measurement results directory. When a path is specified, the current measurement results directory is set to that path.

When `FORMat:[DATA]` is set to binary, results are stored in a binary measurement results file, which can later be loaded with the [MMEMory:LOAD:RESults](#) command. Any user-specified file extension is replaced by the default measurement results file extension for the current measurement mode.

When `FORMat:[DATA]` is set to ASCII, results are stored in an ASCII-format exported results file. To create a tab-separated format file, use a `.txt` file extension. To create a comma-separated format file, use a `.csv` file extension.

If the file extension is omitted, the format will be that last set by `MMEMory:APPData:RESults:DEFault:EXPort:FORMat` command.

When the `<file_name>` argument is omitted, the data is automatically saved in the current measurement results directory with a unique file name.

**Examples** `MMEMory:STORE:RESULTS "RESULT1.csv"` stores the measurement results to the `RESULT1.csv` file as an ASCII comma-separated format file in the current measurement results directory.

## MMEMory:STORe:SCReen(No Query Form)

Stores the instrument screen image to a specified file and format.

The file extension sets the file format type. Valid file extensions are `.png`, `.bmp` and `.jpg`. If the file name does not include a file extension, the format will be the format last set by the `MMEMory:APPData:RESults:DEFault:SCReen:FORMat` command.

This command is ignored and an error event generated when a specified file directory component does not exist or the specified screen image file name already exists.

**Conditions** Measurement modes: All

**Group** Mass memory commands

**Syntax** `MMEMory:STORe:SCReen [<file_name>]`

**Related Commands** [MMEMory:APPData:PREFix](#)  
[MMEMory:APPData:RESults](#)



[MMEMory:APPData:RESults:DEFault:EXPort:FORMat](#)

**Arguments** The optional `<file_name>::=<string>` specifies the path and file name in which to store the screen image. When the string does not include a path component, the file is saved to the current measurement results directory. When a path is specified, the current measurement results directory is set to that path.

When the `<file_name>` argument is omitted, the data is automatically saved in the current measurement results directory with a unique file name.

The file extension sets the file format type. Valid file extensions are .png, .bmp and .jpg. If the file name does not include a file extension then it will use the current default exported screen format.

**Examples** `MMEMORY:STORE:SCREEN "image1.jpg"` stores the *image1.jpg* file in the current stored measurement results directory.

**MMEMory:STORE:STATE (No Query Form)**

Stores the instrument settings to a specified file.

This command is ignored and an error event generated when a specified file directory component does not exist or the specified file name already exists.

**Conditions** Measurement modes: All

**Group** Mass memory commands

**Syntax** `MMEMory:STORE:STATE [<file_name>]`

**Related Commands** [MMEMory:APPData:PREFIX](#)  
[MMEMory:APPData:SETTings](#)  
[MMEMory:LOAD:STATE](#)

**Arguments** The optional `<file_name>::=<string>` specifies the path and file name in which to store the instrument settings file. When the string does not include a path component, the file is saved to the current stored settings directory. When a path is specified, the file is saved at the specified path location.

When the `<file_name>` argument is omitted, the data is automatically saved in the current stored settings directory with a unique file name.

The file extension is .sav. You can omit the extension. Any specified filename extension is discarded and replaced with sav.

**Examples** `MMEMORY:STORE:STATE "STATE1"` stores the instrument settings in the `STATE1.sav` file in the current saved settings directory.

## \*OPC

The \*OPC command generates the operation complete message in the Standard Event Status Register (SESR) when all pending operations finish. The \*OPC? query places the ASCII character "1" into the output queue when all pending operations are finished. The \*OPC? response is not available to read until all pending operations finish.

The \*OPC command allows you to synchronize the operation of the instrument with your application program. Refer to *Synchronizing Execution* (See page 3-7.) for the details.

**Conditions** Measurement modes: All

**Group** IEEE common commands

**Syntax** \*OPC  
\*OPC?

**Arguments** None

**Examples** \*OPC? returns a 1 when all pending operations are finished.

## OUTPut:IF[:STATe]

Sets or queries the state of the IF output. The nominal IF out frequency is 140 MHz. The IF Output signal can only be enabled when in Spectrum mode.

The IF output signal is unavailable when taking Spectrum measurements that require multiple acquisitions. Multiple acquisitions occur when the span is greater than 20 MHz, and can occur for some combinations of manually set RBW. To ensure an IF output signal, set the measurement span to be  $\leq 20$  MHz and set the RBW to Auto.

Enabling the IF output signal results in the instrument measurements being uncalibrated.

This command is ignored and an error event generated when the current instrument settings or measurement mode prohibit the IF output from being enabled.

<b>Conditions</b>	Measurement modes: Spectrum and Amplitude vs. Time
<b>Group</b>	Output commands
<b>Syntax</b>	OUTPut:IF[:STATE] { OFF   ON   0   1 } OUTPut:IF[:STATE]?
<b>Arguments</b>	OFF or 0 turns off IF output. ON or 1 turns on IF output.
<b>Examples</b>	OUTPUT:IF:STATE ON turns on IF output.

## \*RST (No Query Form)

Returns the instrument settings to the factory defaults.

The \*RST command does not alter the following

- Alignment data that affect device specifications.
- The Output Queue.
- The Service Request Enable Register setting.
- The Standard Event Status Enable Register setting.
- Stored settings.

---

**NOTE.** Execution of the \*RST command is not complete until all changes from resetting the instrument are completed. Following commands and queries will not be executed until these actions are completed.

---

<b>Conditions</b>	Measurement modes: All
<b>Group</b>	IEEE common commands
<b>Syntax</b>	*RST

**Related Commands**    [\\*CLS](#)

**Arguments**        None

**Examples**        \*RST returns the instrument settings to the factory defaults.

## [SENSe]:AVTime:ACquisition:MODE

Sets or queries the Amplitude vs. Time measurement signal acquisition time mode.

**Conditions**        Measurement modes: Amplitude vs. Time

**Group**            Sense commands

**Syntax**            [SENSe]:AVTime:ACquisition:MODE { AUTO | LENGTH | SAMPLES }  
[SENSe]:AVTime:ACquisition:MODE?

**Related Commands**    [\[SENSe\]:AVTime:ACquisition:SAMPLES](#)  
[\[SENSe\]:AVTime:ACquisition:SECONDS](#)

**Arguments**        AUTO sets the instrument to automatically assign the acquisition length based on the current Span setting. This results in a maximum number of samples while still providing relatively fast sweep updates.

LENGTH sets the instrument to acquire for a specified time length.

SAMPLES sets the instrument to acquire for a specified number of samples.

**Examples**        SENSE:AVTIME:ACQUISITION:MODE LENGTH sets the instrument to acquire for a specified time length.

## [SENSe]:AVTime:ACquisition:RATE? (Query Only)

Queries for the current Amplitude vs. Time measurement mode sample rate.

**Conditions**        Measurement modes: Amplitude vs. Time

**Group**            Sense commands

<b>Syntax</b>	<code>[SENSe]:AVTime:ACQuisition:RATE?</code>
<b>Arguments</b>	None
<b>Returns</b>	<NRf> indicates the current sample rate in samples per second.
<b>Examples</b>	<code>SENSE:AVTIME:ACQUISITION:RATE?</code> might return 6835, indicating that the sample rate is 6.835 ksps.

## **[SENSe]:AVTime:ACQuisition:SAMPles**

Sets or queries the Amplitude vs. Time measurement mode number of acquisition samples.

<b>Conditions</b>	Measurement modes: Amplitude vs. Time
<b>Group</b>	Sense commands
<b>Syntax</b>	<code>[SENSe]:AVTime:ACQuisition:SAMPles &lt;value&gt;</code> <code>[SENSe]:AVTime:ACQuisition:SAMPles?</code>
<b>Related Commands</b>	<a href="#">[SENSe]:AVTime:ACQuisition:MODE</a> <a href="#">[SENSe]:AVTime:ACQuisition:SEConds</a>
<b>Arguments</b>	<value>::=<NRf> specifies the number of acquisition samples.
<b>Examples</b>	<code>SENSE:AVTime:ACQuisition:SAMPles 10000</code> sets the number of acquisition samples to 10000.

## **[SENSe]:AVTime:ACQuisition:SEConds**

Sets or queries the Amplitude vs. Time measurement mode acquisition time.

<b>Conditions</b>	Measurement modes: Amplitude vs. Time
<b>Group</b>	Sense commands

**Syntax** [SENSe]:AVTime:ACQuisition:SECOnds <value>  
[SENSe]:AVTime:ACQuisition:SECOnds?

**Related Commands** [SENSe]:AVTime:ACQuisition:MODE  
[SENSe]:AVTime:ACQuisition:SAMPles

**Arguments** <value>::=<NRF> specifies the acquisition time (in seconds).

**Examples** SENSE:AVTime:ACQuisition:SECOnds 100e-3 sets the acquisition time to 100 ms.

## [SENSe]:AVTime:FREQuency:MEASurement

Sets or queries the Amplitude vs. Time mode measurement frequency.

This command is ignored and an error event generated when the instrument is not in the Amplitude vs. Time measurement mode.

**Conditions** Measurement modes: Amplitude vs. Time

**Group** Sense commands

**Syntax** [SENSe]:AVTime:FREQuency:MEASurement <value>  
[SENSe]:AVTime:FREQuency:MEASurement?

**Arguments** <value>::=<NRF> specifies the center frequency.  
Range: 10 kHz to 6.2 GHz.

**Examples** SENSE:AVTIME:FREQUENCY:MEASUREMENT 2.5e9 sets the measurement frequency to 2.5 GHz.

## [SENSe]:AVTime:FREQuency:SPAN

Sets or queries the frequency span in the Amplitude vs. Time measurement.

This command is ignored and an error event generated when the instrument is not in the Amplitude vs. Time measurement mode.

**Conditions** Measurement modes: Amplitude vs. Time

<b>Group</b>	Sense commands
<b>Syntax</b>	[SENSE]:AVTime:FREQUENCY:SPAN <value> [SENSE]:AVTime:FREQUENCY:SPAN?
<b>Arguments</b>	<value>::=<Nrf> specifies the frequency span. Range: 5 kHz to 20 MHz.
<b>Examples</b>	SENSE:AVTime:FREQUENCY:SPAN 20e sets the measurement span to 20 MHz.

### [SENSE]:AVTime:MAX:SPAN (No Query Form)

Sets the frequency span to the maximum allowable span.

This command is ignored and an error event generated when the instrument is not in Amplitude vs. Time measurement mode.

<b>Conditions</b>	Measurement modes: Amplitude vs. Time
<b>Group</b>	Sense commands
<b>Syntax</b>	[SENSE]:AVTime:MAX:SPAN
<b>Arguments</b>	None
<b>Examples</b>	SENSE:AVTIME:MAX:SPAN sets the measurement frequency span to the maximum span.

### [SENSE]:DPSA:CLEAr:RESults (No Query Form)

Resets the DPX Spectrum max hold or average trace and the DPX bitmap.

This command is ignored and an error event generated when the instrument is not in the DPX Spectrum measurement mode.

<b>Conditions</b>	Measurement modes: DPX spectrum
<b>Group</b>	Sense commands

**Syntax** [SENSE]:DPSA:CLEAR:RESULTS

**Arguments** None

**Examples** SENSE:DPSA:CLEAR:RESULTS resets the DPX Spectrum max hold or average trace and the DPX bitmap.

## [SENSE]:DPSA:COLOR

Sets or queries the DPX bitmap color mode.

This command is ignored and an error event generated when the instrument is not in the DPX Spectrum measurement mode.

**Conditions** Measurement modes: DPX spectrum

**Group** Sense commands

**Syntax** [SENSE]:DPSA:COLOR { BCYan | TEMPerature | SPECTral }  
[SENSE]:DPSA:COLOR?

**Arguments** The following table lists the arguments:

**Table 2-25: Color palette for DPX Spectrum**

Argument	Palette
BCYan	Binary cyan
TEMPerature	Temperature
SPECTral	Spectral

**Examples** SENSE:DPSA:COLOR TEMPerature sets the temperature color palette to Temperature.

## [SENSE]:DPSA:COLOR:MAXimum

Sets or queries the maximum value of the color axis in the DPX Spectrum measurement.

This command is ignored and an error event generated when the instrument is not in the DPX Spectrum measurement mode.



<b>Conditions</b>	Measurement modes: DPX spectrum
<b>Group</b>	Sense commands
<b>Syntax</b>	[SENSE]:DPSA:COLOR:MAXIMUM <value> [SENSE]:DPSA:COLOR:MAXIMUM?
<b>Arguments</b>	<value> ::= <NRF> specifies the maximum value of the color axis. Range: The minimum value to 100%.  The minimum value is set using the [SENSE]:DPSA:COLOR:MINIMUM command.
<b>Examples</b>	SENSE:DPSA:COLOR:MAXIMUM 90 sets the maximum value of the color axis to 90%.

## [SENSE]:DPSA:COLOR:MINIMUM

Sets or queries the minimum value of the color axis in the DPX spectrum measurement.

This command is ignored and an error event generated when the instrument is not in the DPX Spectrum measurement mode.

<b>Conditions</b>	Measurement modes: DPX spectrum
<b>Group</b>	Sense commands
<b>Syntax</b>	[SENSE]:DPSA:COLOR:MINIMUM <value> [SENSE]:DPSA:COLOR:MINIMUM?
<b>Arguments</b>	<value> ::= <NRF> specifies the minimum value of the color axis. Range: 0% to the maximum value.  The maximum value is set using the [SENSE]:DPSA:COLOR:MAXIMUM command.
<b>Examples</b>	SENSE:DPSA:COLOR:MINIMUM 10 sets the minimum value of the color axis to 10%.

## [SENSe]:DPSA:FREQUENCY:CENTer

Sets or queries the center frequency in the DPX Spectrum measurement.

This command is ignored and an error event generated when the instrument is not in the DPX Spectrum measurement mode.

<b>Conditions</b>	Measurement modes: DPX spectrum
<b>Group</b>	Sense commands
<b>Syntax</b>	[SENSe]:DPSA:FREQUENCY:CENTer <value> [SENSe]:DPSA:FREQUENCY:CENTer?
<b>Related Commands</b>	<a href="#">[SENSe]:DPSA:MAX:SPAN</a>
<b>Arguments</b>	<value>::=<Nrf> specifies the center frequency. Range: 0 Hz to 6.2 GHz.
<b>Examples</b>	SENSe:DPSA:FREQUENCY:CENTer 2.5e9 sets the DPX Spectrum measurement center frequency to 2.5 GHz.

## [SENSe]:DPSA:FREQUENCY:MEASurement

Sets or queries the measurement frequency in the DPX Spectrum measurement.

This command is ignored and an error event generated when the instrument is not in the DPX Spectrum measurement mode.

<b>Conditions</b>	Measurement modes: DPX spectrum
<b>Group</b>	Sense commands
<b>Syntax</b>	[SENSe]:DPSA:FREQUENCY:MEASurement <value> [SENSe]:DPSA:FREQUENCY:MEASurement?
<b>Arguments</b>	<value>::=<Nrf> is the measurement frequency.

**Examples**    `SENSE:DPSA:FREQUENCY:MEASUREMENT 833e6` sets the DPX Spectrum measurement frequency to 833 MHz.

## [SENSe]:DPSA:FREQuency:SPAN

Sets or queries the frequency span in the DPX Spectrum measurement.

This command is ignored and an error event generated when the instrument is not in the DPX Spectrum measurement mode.

**Conditions**    Measurement modes: DPX spectrum

**Group**    Sense commands

**Syntax**    `[SENSe]:DPSA:FREQuency:SPAN <value>`  
`[SENSe]:DPSA:FREQuency:SPAN?`

**Arguments**    `<value> ::= <NRf>` is the frequency span.  
 Range: 5.0 kHz to 20 MHz

**Examples**    `SENSE:DPSA:FREQUENCY:SPAN 20e6` sets the span to 20 MHz.

## [SENSe]:DPSA:MAX:SPAN (No Query Form)

Sets the measurement span for the DPX Spectrum measurement mode to the maximum allowable span.

This command is ignored and an error event generated when the instrument is not in the DPX Spectrum measurement mode.

**Conditions**    Measurement modes: DPX spectrum

**Group**    Sense commands

**Syntax**    `[SENSe]:DPSA:MAX:SPAN`

**Arguments**    None

**Examples**     `SENSE:DPSA:MAX:SPAN` sets the DPX Spectrum measurement mode span to the maximum allowable span.

## [SENSe]:POWer:UNITs

Sets or queries the Spectrum and DPX Spectrum measurement amplitude power units. This command is equivalent to the `UNIT:POWer` command.

**Conditions**     Measurement modes: Spectrum and DPX Spectrum

**Group**     Sense commands

**Syntax**     `[SENSe]:POWer:UNITs { DBM | DBV | VOLTs | WATTs | DBW | DBUV  
| DBMV }`  
`[SENSe]:POWer:UNITs?`

**Related Commands**     [UNIT:POWer](#)

**Arguments**     The following table lists the arguments:

**Table 2-26: Power units**

Argument	Power unit
DBM	dBm
DBV	dBV
VOLTs	Volts
WATTs	Watts
DBW	dBW
DBUV	dB $\mu$ V
DBMV	dBmV

---

**NOTE.** All arguments are supported in the Spectrum and Amplitude vs. Time measurement modes. The `VOLTs` and `WATTs` arguments are not supported in the DPX Spectrum measurement mode, and will generate an execution error if issued while in DPX Spectrum measurement mode.

---

**Examples**     `SENSE:POWer:UNITs DBM` specifies the measurement unit of power as dBm.

## [SENSe]:ROSCillator:SOURce? (Query Only)

Queries the current reference oscillator source.

<b>Conditions</b>	Measurement modes: All
<b>Group</b>	Sense commands
<b>Syntax</b>	[SENSe]:ROSCillator:SOURce?
<b>Arguments</b>	None
<b>Returns</b>	INT when the internal oscillator is being used as the reference oscillator source. EXT when an externally connected reference is being used as the reference oscillator source. GPS when the internal GPS is being used as the reference oscillator source.
<b>Examples</b>	SENSE:ROSCILLATOR:SOURCE? might return EXT, indicating that an externally connected reference is being used as the reference oscillator source for the instrument.

## [SENSe]:SPECtrum:{BANDwidth|BWIDth}[:RESolution]

Sets or queries the Spectrum measurement mode resolution bandwidth (RBW). Manually programming a specified RBW sets [SENSe]:SPECtrum:{BANDwidth|BWIDth}[:RESolution]:AUTO to OFF.

This command is ignored and an error event generated when the instrument is not in the Spectrum measurement mode.

<b>Conditions</b>	Measurement modes: Spectrum
<b>Group</b>	Sense commands
<b>Syntax</b>	[SENSe]:SPECtrum:{BANDwidth BWIDth}[:RESolution] <value> [SENSe]:SPECtrum:{BANDwidth BWIDth}[:RESolution]?
<b>Related Commands</b>	[SENSe]:SPECtrum:{BANDwidth BWIDth}[:RESolution]:AUTO

**Arguments** <value>::=<NRF> specifies the RBW. Range: 10 Hz to 3 MHz.

**Examples** SENSE:SPECTRUM:BANDWIDTH:RESOLUTION 200e3 sets the RBW to 200 kHz.

## [SENSe]:SPECTrum:{BANDwidth|BWIDth}[:RESolution]:AUTO

Determines whether to set the resolution bandwidth (RBW) automatically or manually in the spectrum measurement.

This command is ignored and an error event generated when the instrument is not in the Spectrum measurement mode.

**Conditions** Measurement modes: Spectrum

**Group** Sense commands

**Syntax** [SENSe]:SPECTrum:{BANDwidth|BWIDth}[:RESolution]:AUTO { OFF  
| ON | 0 | 1 }  
[SENSe]:SPECTrum:{BANDwidth|BWIDth}[:RESolution]:AUTO?

**Related Commands** [\[SENSe\]:SPECTrum:FREQuency:SPAN:BANDwidth\[:RESolution\]:RATio](#)  
[\[SENSe\]:SPECTrum:{BANDwidth|BWIDth}\[:RESolution\]](#)

**Arguments** OFF or 0 specifies that the resolution bandwidth is set manually using the [\[SENSe\]:SPECTrum:{BANDwidth|BWIDth}\[:RESolution\]](#) command.

ON or 1 specifies that the resolution bandwidth is set automatically. Automatic RBW range: 10 Hz to 1 MHz.

**Examples** SENSE:SPECTRUM:BANDWIDTH:RESOLUTION:AUTO ON sets the resolution bandwidth automatically.

## [SENSe]:SPECTrum:FREQuency:CENTer

Sets or queries the center frequency in the spectrum measurement.

This command is ignored and an error event generated when the instrument is not in the Spectrum measurement mode.

---

**NOTE.** The center, start and stop frequencies are set interlocking each other with the following relationships:  $(start\ frequency) = (center\ frequency) - (span)/2$  and  $(stop\ frequency) = (center\ frequency) + (span)/2$ .

---

<b>Conditions</b>	Measurement modes: Spectrum
<b>Group</b>	Sense commands
<b>Syntax</b>	[SENSe]:SPECTrum:FREQUENCY:CENTer <value> [SENSe]:SPECTrum:FREQUENCY:CENTer?
<b>Related Commands</b>	[SENSe]:SPECTrum:FREQUENCY:START [SENSe]:SPECTrum:FREQUENCY:STOP
<b>Arguments</b>	<value> ::= <NRf> specifies the center frequency. Range: 10 kHz to 6.2 GHz.
<b>Examples</b>	SENSE:SPECTRUM:FREQUENCY:CENTER 1.5e9 sets the center frequency to 1.5 GHz.

## [SENSe]:SPECTrum:FREQUENCY:MEASurement

Sets or queries the Spectrum mode measurement frequency.

This command is ignored and an error event generated when the instrument is not in the Spectrum measurement mode.

<b>Conditions</b>	Measurement modes: Spectrum
<b>Group</b>	Sense commands
<b>Syntax</b>	[SENSe]:SPECTrum:FREQUENCY:MEASurement <value> [SENSe]:SPECTrum:FREQUENCY:MEASurement?
<b>Related Commands</b>	[SENSe]:SPECTrum:FREQUENCY:START [SENSe]:SPECTrum:FREQUENCY:STOP

**Arguments** <value>::=<NRF> specifies the center frequency.

Range: 10 kHz to 6.2 GHz.

**Examples** SENSE:SPECTRUM:FREQUENCY:CENTER 2.5e9 sets the measurement frequency to 2.5 GHz.

## [SENSE]:SPECTRUM:FREQUENCY:SPAN

Sets or queries the frequency span in the Spectrum measurement.

This command is ignored and an error event generated when the instrument is not in the Spectrum measurement mode.

**Conditions** Measurement modes: Spectrum

**Group** Sense commands

**Syntax** [SENSE]:SPECTRUM:FREQUENCY:SPAN <value>  
[SENSE]:SPECTRUM:FREQUENCY:SPAN?

**Arguments** <value>::=<NRF> specifies the frequency span.

Range: 1 kHz to 6.2 GHz.

**Examples** SENSE:SPECTRUM:FREQUENCY:SPAN 20e6 sets the span to 20 MHz.

## [SENSE]:SPECTRUM:FREQUENCY:SPAN:BANDWIDTH[:RESOLUTION]:RATIO

Sets or queries the ratio of span to RBW (Resolution Bandwidth) in the Spectrum measurement. This command is valid when [\[SENSE\]:SPECTRUM:{BANDWIDTH|BWIDTh}\[:RESOLUTION\]:AUTO](#) is set to On.

This command is ignored and an error event generated when the instrument is not in the Spectrum measurement mode.

**Conditions** Measurement modes: Spectrum

**Group** Sense commands



**Syntax** [SENSE]:SPECTrum:FREQUENCY:SPAN:BANDwidth[:RESolution]:RATio  
 <value>  
 [SENSE]:SPECTrum:FREQUENCY:SPAN:BANDwidth[:RESolution]:  
 RATio?

**Related Commands** [SENSE]:SPECTrum:{BANDwidth|BWIDth}[:RESolution]:AUTO

**Arguments** <value> ::= <Nrf> specifies the ratio of span to RBW. Range: 10 to 1000.  
 Programming a specified ratio sets the RBW equal to the current span divided by the specified ratio, rounded down to the nearest valid value.

**Examples** SENSE:SPECTRUM:FREQUENCY:SPAN:BANDWIDTH:RESOLUTION:RATIO 200  
 sets the ratio to 200, setting the RBW to 200 kHz for the span of 40 MHz.

## [SENSE]:SPECTrum:FREQUENCY:START

Sets or queries the measurement start frequency (left edge on the graph) in the spectrum measurement.

The center, start and stop frequencies are set interlocking each other.

This command is ignored and an error event generated when the instrument is not in the Spectrum measurement mode.

**Conditions** Measurement modes: Spectrum

**Group** Sense commands

**Syntax** [SENSE]:SPECTrum:FREQUENCY:START <value>  
 [SENSE]:SPECTrum:FREQUENCY:START?

**Related Commands** [SENSE]:SPECTrum:FREQUENCY:STOP  
 [SENSE]:SPECTrum:FREQUENCY:CENTER

**Arguments** <value> ::= <Nrf> is the measurement start frequency.

**Examples** SENSE:SPECTRUM:FREQUENCY:START 3.95e9 sets the start frequency to 3.95 GHz.

## [SENSe]:SPECTrum:FREQuency:STOP

Sets or queries the measurement stop frequency (right edge on the graph) in the spectrum measurement.

The center, start and stop frequencies are set interlocking each other.

This command is ignored and an error event generated when the instrument is not in the Spectrum measurement mode.

<b>Conditions</b>	Measurement modes: Spectrum
<b>Group</b>	Sense commands
<b>Syntax</b>	[SENSe]:SPECTrum:FREQuency:STOP <value> [SENSe]:SPECTrum:FREQuency:STOP?
<b>Related Commands</b>	<a href="#">[SENSe]:SPECTrum:FREQuency:START</a> <a href="#">[SENSe]:SPECTrum:FREQuency:CENTer</a>
<b>Arguments</b>	<value>::=<Nrf> is the measurement stop frequency.
<b>Examples</b>	SENSE:SPECTRUM:FREQUENCY:STOP 4.15e9 sets the stop frequency to 4.15 GHz.

## [SENSe]:SPECTrum:MAX:SPAN (No Query Form)

Sets the frequency span to the maximum allowable span.

This command is ignored and an error event generated when the instrument is not in the Spectrum measurement mode.

<b>Conditions</b>	Measurement modes: Spectrum
<b>Group</b>	Sense commands
<b>Syntax</b>	[SENSe]:SPECTrum:MAX:SPAN
<b>Arguments</b>	None

**Examples**    SENSE:SPECTRUM:MAX:SPAN sets the frequency span to the maximum span.

## \*SRE

Sets or queries the value of the Service Request Enable Register (SRER). Refer to Section 3, *Status and Events*, for the register information.

**Conditions**    Measurement modes: All

**Group**    IEEE common commands

**Syntax**    \*SRE <value>  
\*SRE?

**Related Commands**    \*CLS  
\*ESE  
\*ESR?

**Arguments**    <value> ::= <NR1> is a value in the range from 0 to 255. The binary bits of the SRER are set according to this value. Using an out-of-range value causes an execution error.

**Examples**    \*SRE 48 sets binary 00110000 in the SRER's bits.  
\*SRE? might return 32, indicating that the SRER's bit settings are 00100000.

## STATus:AVTime:EVENTs? (Query Only)

Returns the current event and status condition for the Amplitude vs. Time measurement.

**Conditions**    Measurement modes: Amplitude vs. Time measurement

**Group**    Status commands

**Syntax**    STATus:AVTime:EVENTs?

**Arguments**    None

**Returns** <ecode>, “<edesc>”

Where:

<ecode> ::= <NR1> is the error/event code (-32768 to 32767).

<edesc> ::= <string> is the description on the error/event.

If there is no error, the response is 0, "No events to report".

**Examples** STATUS:AVTIME:EVENTS? might return 12005,"Normalization in process", indicating that the instrument is currently performing a normalization.

## STATus:DPSA:EVENTs? (Query Only)

Returns the current event and status condition for the DPX Spectrum measurement.

**Conditions** Measurement modes: DPX Spectrum

**Group** Status commands

**Syntax** STATus:DPSA:EVENTs?

**Arguments** None

**Returns** <ecode>, “<edesc>”

Where:

<ecode> ::= <NR1> is the error/event code (-32768 to 32767).

<edesc> ::= <string> is the description on the error/event.

If there is no error, the response is 0, "No events to report".

**Examples** STATus:DPSA:EVENTs? might return 12005,"Normalization in process", indicating that the instrument is currently performing a normalization.

## STATus:SPECTrum:EVENTs? (Query Only)

Returns the current event and status condition for the Spectrum measurement.

**Conditions** Measurement modes: Spectrum

<b>Group</b>	Status commands
<b>Syntax</b>	STATUS:SPECTRUM:EVENTS?
<b>Arguments</b>	None
<b>Returns</b>	<p>&lt;ecode&gt; , “&lt;edesc&gt;”</p> <p>Where:</p> <p>&lt;ecode&gt; ::= &lt;NR1&gt; is the error/event code (-32768 to 32767).</p> <p>&lt;edesc&gt; ::= &lt;string&gt; is the description on the error/event.</p> <p>If there is no error, the response is 0, "No events to report".</p>
<b>Examples</b>	STATUS:SPECTRUM:EVENTS? might return 12005,"Normalization in process", indicating that the instrument is currently performing a normalization.

## \*STB? (Query Only)

Returns the contents of the Status Byte Register (SBR) in the status/event reporting structure using the Master Summary Status (MSS) bit. Refer to Section 3, *Status and Events*, for the register information.

<b>Conditions</b>	Measurement modes: All
<b>Group</b>	IEEE common commands
<b>Syntax</b>	*STB?
<b>Related Commands</b>	<p>*CLS</p> <p>*ESE</p> <p>*ESR?</p> <p>*SRE</p>
<b>Arguments</b>	None
<b>Returns</b>	<NR1> representing the contents of the SBR as a decimal number.

**Examples** \*STB? might return 96, indicating that the SBR contains binary 0110 0000.

## SYSTEM:COMMunicate:LOGGing:GPS[:SOCKeT]:ADDRess

Sets or queries the UDP address to which to send GPS time/location logging data.

This command is ignored and an error event generated if the specified UDP address does not adhere to an N.N.N.N format.

**Conditions** Measurement modes: All

**Group** System commands

**Syntax** SYSTEM:COMMunicate:LOGGing:GPS[:SOCKeT]:ADDRess <value>  
SYSTEM:COMMunicate:LOGGing:GPS[:SOCKeT]:ADDRess?

**Related Commands** [SYSTEM:COMMunicate:LOGGing:GPS\[:SOCKeT\]:PORT](#)  
[SYSTEM:LOGGing:GPS](#)  
[SYSTEM:LOGGing:GPS:FILE\[:NAME\]](#)

**Arguments** <value>::=<string> specifies the UDP address to which to send GPS time/location logging data.

**Examples** SYSTEM:COMMUNICATE:LOGGING:GPS:SOCKET:ADDRESS  
"128.181.23.45" sets the instrument to send GPS time/location logging data to UDP address 128.181.23.45.

## SYSTEM:COMMunicate:LOGGing:GPS[:SOCKeT]:PORT

Sets or queries the UDP port to which to send GPS time/location logging data.

**Conditions** Measurement modes: All

**Group** System commands

**Syntax** SYSTEM:COMMunicate:LOGGing:GPS[:SOCKeT]:PORT <value>  
SYSTEM:COMMunicate:LOGGing:GPS[:SOCKeT]:PORT?

<b>Related Commands</b>	<a href="#">SYSTem:COMMunicate:LOGGing:GPS[:SOCKeT]:ADDRess</a> <a href="#">SYSTem:LOGGing:GPS</a> <a href="#">SYSTem:LOGGing:GPS:FILE[:NAME]</a>
<b>Arguments</b>	<value> ::= <NR1> specifies the UDP port number to which to send GPS time/location logging data.
<b>Examples</b>	SYSTEM:COMMUNICATE:LOGGING:GPS:SOCKET:PORT 21010 sets the UDP port to 21010.

## SYSTem:COMMunicate:LOGGing:RESuLts[:SOCKeT]:ADDRess

Sets or queries the UDP address to which to send the measurement result logging data.

This command is ignored and an error event generated if the specified UDP address does not adhere to an N.N.N.N format.

<b>Conditions</b>	Measurement modes: All
<b>Group</b>	System commands
<b>Syntax</b>	SYSTem:COMMunicate:LOGGing:RESuLts[:SOCKeT]:ADDRess <value> SYSTem:COMMunicate:LOGGing:RESuLts[:SOCKeT]:ADDRess?
<b>Related Commands</b>	<a href="#">SYSTem:LOGGing:RESuLts</a> <a href="#">SYSTem:COMMunicate:LOGGing:RESuLts[:SOCKeT]:PORT</a> <a href="#">SYSTem:LOGGing:RESuLts:FILE[:NAME]</a>
<b>Arguments</b>	<value> ::= <string> specifies the UDP address to which to send measurement logging data.
<b>Examples</b>	SYSTEM:COMMUNICATE:LOGGING:RESULTS:SOCKET:ADDRESS "181.123.45.67" sets the instrument to send measurement result logging data to UDP address 181.123.45.67.

## SYSTem:COMMunicate:LOGGing:RESuLts[:SOCKeT]:PORT

Sets or queries the UDP port to which to send measurement result logging data.

<b>Conditions</b>	Measurement modes: All
<b>Group</b>	System commands
<b>Syntax</b>	<pre> SYSTEM:COMMunicate:LOGGing:RESuIts[:SOCKET]:PORT &lt;value&gt; SYSTEM:COMMunicate:LOGGing:RESuIts[:SOCKET]:PORT?                     </pre>
<b>Related Commands</b>	<a href="#">SYSTEM:LOGGing:RESuIts</a> <a href="#">SYSTEM:COMMunicate:LOGGing:RESuIts[:SOCKET]:ADDRess</a> <a href="#">SYSTEM:LOGGing:RESuIts:FILE[:NAME]</a>
<b>Arguments</b>	<value> ::= <NR1> specifies the UDP port number to which to send measurement results logging data.
<b>Examples</b>	SYSTEM:COMMUNICATE:LOGGING:RESULTS:SOCKET:PORT 21010 sets the measurement results UDP port to 21010.

## SYSTEM:DATE? (Query Only)

Queries the current instrument date setting.

<b>Conditions</b>	Measurement modes: All
<b>Group</b>	System commands
<b>Syntax</b>	SYSTEM:DATE?
<b>Related Commands</b>	<a href="#">SYSTEM:TIME?</a>
<b>Arguments</b>	None.
<b>Returns</b>	<NR1>, <NR1>, <NR1> represent the year, month, and day values of the current system date setting.
<b>Examples</b>	SYSTEM:DATE? might return 2009, 7, 17, indicating the current instrument date setting is July 17, 2009.



## SYSTem:ERRor:COUNT? (Query Only)

Queries the error/event queue for the number of unread items. As errors and events may occur at any time, more items may be present in the queue at the time it is actually read.

<b>Conditions</b>	Measurement modes: All
<b>Group</b>	System commands
<b>Syntax</b>	SYSTem:ERRor:COUNT?
<b>Arguments</b>	None
<b>Returns</b>	<NR1> is the number of errors/events. If the queue is empty, the response is 0.
<b>Examples</b>	SYSTem:ERRor:COUNT? might return 2, indicating that the error/event queue contains two unread errors/events.

## SYSTem:ERRor[:NEXT]? (Query Only)

Queries the next item in the error/event queue (which is removed from queue after the query). The response returns the full queue item consisting of an integer and a string. (See Table 3-3.)

<b>Conditions</b>	Measurement modes: All
<b>Group</b>	System commands
<b>Syntax</b>	SYSTem:ERRor[:NEXT]?
<b>Arguments</b>	None
<b>Returns</b>	<ecode>,"<edesc>[;<einfo>]" Where: <ecode> ::= <NR1> is the error/event code, ranging from -32768 to 32767.

<edesc>::=<string> is the description on the error/event.  
<einfo>::=<string> is the additional information on the error/event.

**Examples** SYSTEM:ERROR:NEXT? might return -113, "Undefined header; Command not found; FETCh:DPSA:TRACe2?", indicating that the command issued was invalid.

## SYSTem:GPS

Sets or queries the GPS receiver operational mode.

**Conditions** Measurement modes: All

**Group** System commands

**Syntax** SYSTem:GPS { NONE | EXTerna1 | INTerna1 }  
SYSTem:GPS?

**Arguments** NONE disables GPS operation.  
EXTerna1 enables operation with an externally connected GPS.  
INTerna1 enables operation with the internal GPS.

**Examples** SYSTEM:GPS INTERNAL sets the instrument to use the internal GPS receiver.

## SYSTem:GPS:POSition? (Query Only)

Queries the current GPS provided latitude and longitude in decimal degrees units.  
In the case where GPS operation is disabled, or GPS is not currently locked, the query response values for both parameters is "NAN".

**Conditions** Measurement modes: All

**Group** System commands

**Syntax** SYSTem:GPS:POSition?

<b>Arguments</b>	None
<b>Returns</b>	<Nrf> , <Nrf> contains the comma-separated latitude and longitude numbers. North latitudes are positive, south latitudes are negative. East longitudes are positive, west longitudes are negative.
<b>Examples</b>	SYSTEM:GPS:POSITION? might return 45.4991875, -122.823165833333, indicating the current latitude and longitude of the instrument.

## SYSTEM:GPS:STATUS? (Query Only)

Queries the current GPS signal lock status.

<b>Conditions</b>	Measurement modes: All
<b>Group</b>	System commands
<b>Syntax</b>	SYSTEM:GPS:STATUS?
<b>Arguments</b>	None
<b>Returns</b>	DIS indicates that GPS is not currently enabled. GOOD indicates that the GPS receiver is locked to four or more satellites. FAIR indicates that the GPS receiver is locked to less than four satellites. BAD indicates that the GPS receiver is disabled or is not locked to any satellites.
<b>Examples</b>	SYSTEM:GPS:STATUS? might return "FAIR, indicating that the GPS receiver is locked to less than four satellites.

## SYSTEM:LOGGING:GPS

Sets or queries the GPS time/location logging mode.

<b>Conditions</b>	Measurement modes: All
<b>Group</b>	System commands

**Syntax**      `SYSTem:LOGGing:GPS { NONE | FILE | UDP }`  
`SYSTem:LOGGing:GPS?`

**Related Commands**    `SYSTem:COMMunicate:LOGGing:GPS[:SOCKeT]:ADDRess`  
`SYSTem:COMMunicate:LOGGing:GPS[:SOCKeT]:PORT`  
`SYSTem:LOGGing:GPS:FILE[:NAME]`

**Arguments**      NONE disables GPS time/location logging.  
 FILE enables GPS time/location logging to a file on the instrument.  
 UDP enables GPS time/location logging to a UDP (network) address.

**Examples**      `SYSTem:LOGGING:GPS FILE` enables GPS time/location logging to a file on the instrument.

## **SYSTem:LOGGing:GPS:FILE[:NAME]**

Set or queries the GPS time/location log file name.

This command is ignored and an error event generated if the directory component of the specified GPS time/location log file does not exist or the specified GPS time/location log file name already exists.

**Conditions**      Measurement modes: All

**Group**            System commands

**Syntax**          `SYSTem:LOGGing:GPS:FILE[:NAME] <file>`  
`SYSTem:LOGGing:GPS:FILE[:NAME]?`

**Related Commands**    `SYSTem:COMMunicate:LOGGing:GPS[:SOCKeT]:ADDRess`  
`SYSTem:COMMunicate:LOGGing:GPS[:SOCKeT]:PORT`  
`SYSTem:LOGGing:RESults`

**Arguments**      `<file>::=<string>` specifies the path and file name at which to store GPS time/location logging files. If the specified name does not include a path component, the file is stored at the current measurement results directory.

**Examples**     `SYSTEM:LOGGING:GPS:FILE:NAME "GpsLocFile1"` sets the instrument to save the GPS time/location logging file to the current measurement results directory with the specified file name.

## SYSTEM:LOGGING:RESULTS

Sets or queries the measurement result logging mode

**Conditions**     Measurement modes: All

**Group**     System commands

**Syntax**     `SYSTEM:LOGGING:RESULTS { NONE | FILE | UDP }`  
`SYSTEM:LOGGING:RESULTS?`

**Related Commands**     [SYSTEM:COMMUNICATE:LOGGING:RESULTS\[:SOCKET\]:ADDRESS](#)  
[SYSTEM:COMMUNICATE:LOGGING:RESULTS\[:SOCKET\]:PORT](#)  
[SYSTEM:LOGGING:RESULTS:FILE\[:NAME\]](#)

**Arguments**     NONE disables measurement results logging.

FILE enables saving measurement result logging files to a location on the instrument.

UDP enables saving measurement result logging data to a UDP (network) address.

**Examples**     `SYSTEM:LOGGING:RESULTS FILE` sets the instrument to save measurement result logging files to a location on the instrument.

## SYSTEM:LOGGING:RESULTS:FILE[:NAME]

Sets or queries measurement results logging file name.

This command is ignored and an error event generated if a directory component of the specified log file does not exist or the specified log file name already exists.

**Conditions**     Measurement modes: All

**Group**     System commands

**Syntax**      `SYSTem:LOGGing:RESuLts:FILE[:NAME] <file>`  
`SYSTem:LOGGing:RESuLts:FILE[:NAME]?`

**Related Commands**    [SYSTem:LOGGing:RESuLts](#)  
[SYSTem:COMMunicate:LOGGing:RESuLts\[:SOCKEt\]:ADDResS](#)  
[SYSTem:COMMunicate:LOGGing:RESuLts\[:SOCKEt\]:PORT](#)

**Arguments**      `<file>::=<string>` specifies the path and file name at which to store measurement results logging files. If the specified name does not include a path component, the file is stored at the current measurement results directory.

**Examples**      `SYSTem:LOGGing:RESuLts:FILE:NAME "MeasLogFile"` sets the instrument to save the measurement results logging file to the current measurement results directory with the specified file name.

## SYSTem:TIME? (Query Only)

Queries the current instrument time setting.

**Conditions**      Measurement modes: All

**Group**            System commands

**Syntax**          `SYSTem:TIME?`

**Related Commands**    [SYSTem:DATE?](#)

**Arguments**      None.

**Returns**          `<NR1>`, `<NR1>`, `<NR1>` representing the hour, minute, and second values of the current system time setting.

**Examples**      `SYSTem:TIME?` might return `14,45,12`, indicating the current instrument time setting (2:45:12 PM).

## TRACe<x>:AVTime

Sets or queries visibility of waveform traces in Amplitude vs. Time measurement mode.

This command is ignored and an error event generated when the instrument is not in the Amplitude vs. Time measurement mode.

The Trace parameter <x> = 2 for command executions (Trace 1 is always visible and cannot be disabled).

The Trace parameter <x> = 1 or 2 for query executions.

**Conditions** Measurement modes: Amplitude vs. Time

**Group** Trace commands

**Syntax** TRACe<x>:AVTime { OFF | ON | 0 | 1 }  
TRACe<x>:AVTime?

**Arguments** OFF or 0 hides the specified trace.  
ON or 1 shows the specified trace.

**Examples** TRACE2:AVTime ON enables displaying Trace 2 in the Amplitude vs. Time measurement mode.

## TRACe<x>:AVTime:AVERage:COUNT

Sets or queries the number of traces to average when the Amplitude vs. Time measurement mode trace function is set to average.

This command is ignored and an error event generated when the instrument is not in the Amplitude vs. Time measurement mode or if waveform averaging is not enabled on the specified trace.

The Trace parameter <x> = 1 or 2.

---

**NOTE.** *The average count value applies to both Trace 1 and Trace 2. Therefore setting a count value for Trace 1 also sets the count value for Trace 2.*

---

**Conditions** Measurement modes: Amplitude vs. Time

<b>Group</b>	Trace commands
<b>Syntax</b>	TRACE<x>:AVTime:AVERAge:COUNT <number> TRACE<x>:AVTime:AVERAge:COUNT?
<b>Arguments</b>	<number> ::= <NR1> specifies the number of traces to combine for averaging. Range: 1 to 200.
<b>Examples</b>	TRACE1:AVTime:AVERAge:COUNT 64 sets the average count to 64 for Trace 1 (and Trace 2 if enabled).

## TRACe<x>:AVTime:AVERAge:PROGress? (Query Only)

Queries the number of times the specified Amplitude vs. Time measurement waveform trace has been averaged.

This command is ignored and an error event generated when the instrument is not in the Amplitude vs. Time measurement mode.

The Trace parameter <x> = 1 or 2.

---

**NOTE.** The average count applies to both Trace 1 and Trace 2. Therefore querying a value for Trace 1 is equal to querying the value for Trace 2.

---

<b>Conditions</b>	Measurement modes: Amplitude vs. Time
<b>Group</b>	Trace commands
<b>Syntax</b>	TRACe<x>:AVTime:AVERAge:PROGress?
<b>Arguments</b>	None
<b>Examples</b>	TRACE1:AVTIME:AVERAGE:PROGRESS? might return 118, indicating that Amplitude vs. Time waveform Trace 1 (and Trace 2 if enabled) have been averaged 118 times.



## TRACe<x>:AVTime:AVERAge:RESet (No Query Form)

Resets the specified Amplitude vs. Time mode waveform trace averaging and restarts the trace averaging process.

This command is ignored and an error event generated when the instrument is not in the Amplitude vs. Time measurement mode or when the specified Amplitude vs. Time mode trace is not set to average acquisition mode.

The Trace parameter <x> = 1 or 2.

---

**NOTE.** *The reset applies to both Trace 1 and Trace 2. Therefore resetting Trace 1 also resets Trace 2.*

---

<b>Conditions</b>	Measurement modes: Amplitude vs. Time
<b>Group</b>	Trace commands
<b>Syntax</b>	TRACe<x>:AVTime:AVERAge:RESet
<b>Arguments</b>	None
<b>Examples</b>	TRACE1:AVTIME:AVERAGE:RESET clears average data and counter, and restarts the average process for Trace 1 (and Trace 2 if enabled).

## TRACe<x>:AVTime:COUNT:RESet (No Query Form)

Resets the Amplitude vs. Time mode Min Hold, Max Hold, or Min/Max Hold trace waveforms for Trace 1 and Trace 2. This command is effective when TRACe<x>:AVTime:FUNCTION is set to MAXHold, MINHold, or BOTH.

This command is ignored and an error event generated when the instrument is not in the Amplitude vs. Time measurement mode or when the specified Amplitude vs. Time mode trace is not set to max hold, min hold, or min/max hold acquisition mode.

The Trace parameter <x> = 1 or 2.

---

**NOTE.** *The reset applies to both Trace 1 and Trace 2. Therefore resetting Trace 1 also resets Trace 2.*

---

<b>Conditions</b>	Measurement modes: Amplitude vs. Time
-------------------	---------------------------------------

<b>Group</b>	Trace commands
<b>Syntax</b>	TRACe<x>:AVTime:COUNT:RESet
<b>Arguments</b>	None
<b>Examples</b>	TRACE1:AVTIME:COUNT:RESET clears the Min Hold, Max Hold, or Min/Max Hold data and counter, and restarts the process for Trace 1 (and Trace 2 if enabled).

## TRACe<x>:AVTime:DETection

Sets or queries the algorithm used to decimate (decrease) the raw acquisition data down to a reasonable number of measurement points. Each Amplitude vs. Time waveform point corresponds to a time range, or bin, within the measurement acquisition. When the Amplitude vs. Time analysis results in multiple points per bin, the detector setting determines how the multiple points are condensed to the single output waveform point for that bin.

This command is ignored and an error event generated when the instrument is not in the Amplitude vs. Time measurement mode.

The Trace parameter <x> = 1 or 2.

---

**NOTE.** This command applies to both Trace 1 and Trace 2. Therefore setting the Trace 1 detector mode also sets the Trace 2 detector mode.

---

<b>Conditions</b>	Measurement modes: Amplitude vs. Time
<b>Group</b>	Trace commands
<b>Syntax</b>	TRACe<x>:AVTime:DETection { AVERAge   POSitive   NEGative   BOTH } TRACe<x>:AVTime:DETection?
<b>Arguments</b>	AVERAge sets the display to show the average value for each bin.  POSitive sets the display to show the maximum (positive peak) data value for each bin.  NEGative sets the display to show the minimum (negative peak) data value for each bin.

BOTH sets the display to show a vertical bar for each bin, showing the maximum and minimum acquisition point values.

**Examples** TRACE1:AVTIME:DETECTION POSITIVE displays the maximum data value for each bin of Trace 1 (and Trace 2 if enabled).

## TRACe<x>:AVTime:FOReground

Sets or queries the foreground status of the specified Amplitude vs. Time measurement trace.

This command is ignored and an error event generated when the instrument is not in the Amplitude vs. Time measurement mode or the specified trace is disabled.

The Trace parameter <x> = 1 or 2. All traces are valid.

**Conditions** Measurement modes: Amplitude vs. Time

**Group** Trace commands

**Syntax** TRACe<x>:AVTime:FOReground { OFF | ON | 0 | 1 }  
TRACe<x>:AVTime:FOReground?

**Arguments** OFF or 0 sets the front-most trace to the next available enabled trace.  
ON or 1 sets the specified trace to be the front-most trace.

**Examples** TRACE2:AVTIME:FOREGROUND ON sets Trace 2 as the front-most trace in the Amplitude vs. Time measurement mode.

## TRACe<x>:AVTime:FUNcTion

Sets or queries the function for the specified trace in the Amplitude vs. Time measurement mode.

This command is ignored and an error event generated when the instrument is not in the Amplitude vs. Time measurement mode or when the specified trace is not enabled.

The Trace parameter <x> = 1 or 2.

**Conditions** Measurement modes: Amplitude vs. Time

<b>Group</b>	Trace commands
<b>Syntax</b>	<pre>TRACe&lt;x&gt;:AVTime:FUNCTion { NORMAl   AVERAge   MAXHOld   MINHOld   BOTH } TRACe&lt;x&gt;:AVTime:FUNCTion?</pre>
<b>Arguments</b>	<p>NORMAl sets the display to show the normal Amplitude vs. Time display.</p> <p>AVERAge sets the display to show the average signal level at each waveform point.</p> <p>MAXHOld sets the display to show the maximum signal level at each waveform point.</p> <p>MINHOld sets the display to show the minimum signal level at each waveform point.</p> <p>BOTH sets the display to show both the maximum and minimum signal levels at each waveform point.</p>
<b>Examples</b>	<p>TRACE2:AVTIME:FUNCTION MAXHOld sets the Trace 2 waveform to show the maximum signal level at each waveform point in the Amplitude vs. Time measurement mode.</p>

## TRACe<x>:DPSA:AVERAge:COUNT

Sets or queries the number of traces to average in the DPX Spectrum view.

This command is ignored and an error event generated when the instrument is not in the DPX Spectrum measurement mode.

The Trace parameter <x> = 1; only Trace 1 is valid.

<b>Conditions</b>	Measurement modes: DPX spectrum
<b>Group</b>	Trace commands
<b>Syntax</b>	<pre>TRACe&lt;x&gt;:DPSA:AVERAge:COUNT &lt;number&gt; TRACe&lt;x&gt;:DPSA:AVERAge:COUNT?</pre>
<b>Arguments</b>	<p>&lt;number&gt;::=&lt;NR1&gt; specifies the number of traces to combine for averaging. Range: 1 to 200.</p>

**Examples** TRACE1:DPSA:AVERAGE:COUNT 32 sets the number of DPX traces to average to 32.

## TRACe<x>:DPSA:AVERAge:PROGress? (Query Only)

Queries the number of times the current DPX Spectrum mode average waveform has been averaged.

This command is ignored and an error event generated when the instrument is not in the DPX Spectrum measurement mode.

The Trace parameter <x> = 1; only Trace 1 is valid.

**Conditions** Measurement modes: DPX spectrum

**Group** Trace commands

**Syntax** TRACe<x>:DPSA:AVERAge:PROGress?

**Arguments** None.

**Examples** TRACE1:DPSA:AVERAGE:PROGRESS? might return 32, indicating that 32 DPX Spectrum waveforms have been averaged.

## TRACe<x>:DPSA:AVERAge:RESet (No Query Form)

Resets the waveform averaging in the DPX Spectrum mode.

This command is ignored and an error event generated when the instrument is not in the DPX Spectrum measurement mode or the current DPX trace mode is not set to Average.

The Trace parameter <x> = 1; only Trace 1 is valid.

**Conditions** Measurement modes: DPX spectrum

**Group** Trace commands

**Syntax** TRACe<x>:DPSA:AVERAge:RESet

**Arguments** None.

**Examples** TRACE1:DPSA:AVERAGE:RESET resets the DPX Spectrum mode average trace.

## TRACe<x>:DPSA:COLor:INTensity

Sets or queries the color intensity in the DPX spectrum view.

This command is ignored and an error event generated when the instrument is not in the DPX Spectrum measurement mode.

The Trace parameter <x> = 5; only Trace 5 (the bitmap) is valid.

**Conditions** Measurement modes: DPX spectrum

**Group** Trace commands

**Syntax** TRACe<x>:DPSA:COLor:INTensity <value>  
TRACe<x>:DPSA:COLor:INTensity?

**Arguments** <value>::=<Nrf> specifies color intensity. Range: 1 to 100%.

**Examples** TRACE1:DPSA:COLOR:INTENSITY 30 sets the color intensity to 30%.

## TRACe<x>:DPSA:COUNt:RESet (No Query Form)

Resets the DPX Spectrum mode max hold trace.

This command is ignored and an error event generated when the instrument is not in the DPX Spectrum measurement mode or the current DPX Spectrum trace mode is not set to max hold.

The Trace parameter <x> = 1; only Trace 1 is valid when the trace function has been set to max hold.

**Conditions** Measurement modes: DPX spectrum

**Group** Trace commands

**Syntax** TRACe<x>:DPSA:COUNt:RESet

**Arguments** None.

**Examples** TRACE1:DPSA:COUNT:RESET resets the DPX Spectrum max hold trace.

## TRACe<x>:DPSA:DETection

Sets or queries the DPX Spectrum mode detector.

This command is ignored and an error event generated when the instrument is not in the DPX Spectrum measurement mode or if you attempt to set the detector to Positive when the DPX Spectrum trace mode is set to max hold.

The Trace parameter <x> = 1; only Trace 1 is valid.

**Conditions** Measurement modes: DPX spectrum

**Group** Trace commands

**Syntax** TRACe<x>:DPSA:DETection { AVERAge | POSitive }  
TRACe<x>:DPSA:DETection?

**Arguments** AVERAge sets the DPX Spectrum detector mode to Average.

POSitive sets the DPX Spectrum detector mode to Positive.

**Examples** TRACE1:DPSA:DETECTION AVERAGE sets the DPX Spectrum detector mode to Average.

## TRACe<x>:DPSA:DOT:PERSiistent

Enables or disables the dot persistence for the bitmap trace in the DPX Spectrum measurement.

This command is ignored and an error event generated when the instrument is not in the DPX Spectrum measurement mode.

The Trace parameter <x> = 5; only Trace 5 (bitmap trace) is valid.

**Conditions** Measurement modes: DPX spectrum

**Group** Trace commands

**Syntax** TRACe<x>:DPSA:DOT:PERsistent { OFF | ON | 0 | 1 }  
 TRACe<x>:DPSA:DOT:PERsistent?

**Related Commands** [TRACe<x>:DPSA:DOT:PERsistent:TYPE](#)  
[TRACe<x>:DPSA:DOT:PERsistent:VARiable](#)

**Arguments** OFF or 0 disables the dot persistence.  
 ON or 1 enables the dot persistence.

**Examples** TRACE5:DPSA:DOT:PERSISTENT ON enables the dot persistence in the DPX Spectrum view.

## TRACe<x>:DPSA:DOT:PERsistent:TYPE

Sets or queries the persistence type for the bitmap trace in the DPX Spectrum measurement.

This command is ignored and an error event generated when the instrument is not in the DPX Spectrum measurement mode or when dot persistence is not currently enabled.

The Trace parameter <x> = 5; only Trace 5 (bitmap trace) is valid.

**Conditions** Measurement modes: DPX spectrum

**Group** Trace commands

**Syntax** TRACe<x>:DPSA:DOT:PERsistent:TYPE { VARiable | INFinite }  
 TRACe<x>:DPSA:DOT:PERsistent:TYPE?

**Related Commands** [TRACe<x>:DPSA:DOT:PERsistent](#)  
[TRACe<x>:DPSA:DOT:PERsistent:VARiable](#)

**Arguments** VARiable sets the variable persistence display to leave acquired data points on the display for a period of time specified by the [TRACe<x>:DPSA:DOT:PERsistent:VARiable](#) command.

INFinite sets the instrument to show accumulated data points on the DPX Spectrum measurement for an indefinite period.



**Examples** TRACE5:DPSA:DOT:PERSISTENT:TYPE VARIABLE selects the variable persistence display mode.

## TRACe<x>:DPSA:DOT:PERsistent:VARiable

Sets or queries the decay period for how long a bitmap point is displayed before fading. Note that this setting has no units associated with it. The greater the persistence and intensity setting, the longer each dot remains displayed on the screen before fading. This command is effective when [TRACe<x>:DPSA:DOT:PERsistent:TYPE](#) is set to VARIABLE.

This command is ignored and an error event generated when the instrument is not in the DPX Spectrum measurement mode, when dot persistence is not currently enabled, or when the dot persistence type is not currently set to Variable.

The Trace parameter <x> = 5; only Trace 5 (bitmap trace) is valid.

**Conditions** Measurement modes: DPX spectrum

**Group** Trace commands

**Syntax** TRACe<x>:DPSA:DOT:PERsistent:VARiable <number>  
TRACe<x>:DPSA:DOT:PERsistent:VARiable?

**Related Commands** [TRACe<x>:DPSA:DOT:PERsistent](#)  
[TRACe<x>:DPSA:DOT:PERsistent:TYPE](#)

**Arguments** <number> ::= <NR1> specifies the period that the bitmap data points are displayed on the screen. Range: 1 to 1000 (unitless; the default value is 10).

**Examples** TRACE5:DPSA:DOT:PERSISTENT:VARIABLE 20 specifies that the bitmap data points are displayed on the screen for a period of 20 before fading.

## TRACe<x>:DPSA:FUNcTion

Sets or queries the DPX Spectrum trace function.

This command is ignored and an error event generated when the instrument is not in the DPX Spectrum measurement mode.

The Trace parameter <x> = 1; only Trace 1 is valid.

<b>Conditions</b>	Measurement modes: DPX spectrum
<b>Group</b>	Trace commands
<b>Syntax</b>	TRACe<x>:DPSA:FUNCTION { NORMAl   HOLD   AVERAge } TRACe<x>:DPSA:FUNCTION?
<b>Arguments</b>	NORMAl sets the DPX Spectrum mode trace function to Normal. HOLD sets the DPX Spectrum mode trace function to Max Hold. AVERAge sets the DPX Spectrum mode trace function to Average.
<b>Examples</b>	TRACE1:DPSA:FUNCTION HOLD sets the DPX Spectrum trace function to Max Hold.

## TRACe<x>:SPECtrum

Sets or queries visibility of waveform traces in Spectrum measurement mode.

This command is ignored and an error event generated when the instrument is not in the Spectrum measurement mode.

The Trace parameter <x> = 2 to 5 for command executions; Trace 1 is always visible and cannot be disabled.

<b>Conditions</b>	Measurement modes: Spectrum
<b>Group</b>	Trace commands
<b>Syntax</b>	TRACe<x>:SPECtrum { OFF   ON   0   1 } TRACe<x>:SPECtrum?
<b>Arguments</b>	OFF or 0 hides the specified trace. ON or 1 shows the specified trace.
<b>Examples</b>	TRACE3:SPECTRUM ON enables displaying Trace 3 in the Spectrum measurement view.

## TRACe<x>:SPECTrum:AVERAge:COUNT

Sets or queries the number of traces to average when the Spectrum measurement mode trace function is set to average.

This command is ignored and an error event generated when the instrument is not in the Spectrum measurement mode or if waveform averaging is not enabled on the specified trace.

The Trace parameter <x> = 1 or 2.

**Conditions** Measurement modes: Spectrum

**Group** Trace commands

**Syntax** TRACe<x>:SPECTrum:AVERAge:COUNT <number>  
TRACe<x>:SPECTrum:AVERAge:COUNT?

**Arguments** <number> ::= <NR1> specifies the number of traces to combine for averaging.  
Range: 1 to 200.

---

**NOTE.** *The average count value applies to both Trace 1 and Trace 2. Therefore specifying a value for Trace 1 also applies that value to Trace 2.*

---

**Examples** TRACE1:SPECTRUM:AVERAGE:COUNT 64 sets the average count to 64 for Trace 1 (and Trace 2 if enabled).

## TRACe<x>:SPECTrum:AVERAge:PROGress? (Query Only)

Queries the number of times the specified Spectrum measurement waveform trace has been averaged.

This command is ignored and an error event generated when the instrument is not in the Spectrum measurement mode.

The parameter <x> = 1 or 2.

---

**NOTE.** *The average count applies to both Trace 1 and Trace 2. Therefore querying a value for Trace 1 is equal to querying the value for Trace 2.*

---

**Conditions** Measurement modes: Spectrum

<b>Group</b>	Trace commands
<b>Syntax</b>	TRACe<x>:SPECTrum:AVERAge:PROGress?
<b>Arguments</b>	None
<b>Examples</b>	TRACE1:SPECTRUM:AVERAGE:PROGRESS? might return 118, indicating that Spectrum waveform Trace 1 ( and Trace 2 if enabled) have been averaged 118 times.

### TRACe<x>:SPECTrum:AVERAge:RESet (No Query Form)

Resets the specified Spectrum mode waveform trace averaging and restarts the trace averaging process.

This command is ignored and an error event generated when the instrument is not in the Spectrum measurement mode or when the specified Spectrum mode trace is not set to average acquisition mode.

The Trace parameter <x> = 1 or 2.

---

**NOTE.** *The reset applies to both Trace 1 and Trace 2. Therefore resetting Trace 1 also resets Trace 2.*

---

<b>Conditions</b>	Measurement modes: Spectrum
<b>Group</b>	Trace commands
<b>Syntax</b>	TRACe<x>:SPECTrum:AVERAge:RESet
<b>Arguments</b>	None
<b>Examples</b>	TRACE1:SPECTRUM:AVERAGE:RESET clears average data and counter, and restarts the average process for Trace 1 (and Trace 2 if enabled).

## TRACe<x>:SPECTrum:COUNT:RESet (No Query Form)

Resets the Spectrum mode Min Hold, Max Hold, or Min/Max Hold trace waveforms for Trace 1 and Trace 2. This command is effective when TRACe<x>:SPECTrum:FUNctioN is set to MAXHold, MINHold, or BOTH.

This command is ignored and an error event generated when the instrument is not in the Spectrum measurement mode or when the specified Spectrum mode trace is not set to max hold, min hold, or min/max hold acquisition mode.

The Trace parameter <x> = 1 or 2.

---

**NOTE.** *The reset applies to both Trace 1 and Trace 2. Therefore resetting Trace 1 also resets Trace 2.*

---

<b>Conditions</b>	Measurement modes: Spectrum
<b>Group</b>	Trace commands
<b>Syntax</b>	TRACe<x>:SPECTrum:COUNT:RESet
<b>Arguments</b>	None
<b>Examples</b>	TRACE1:SPECTRUM:COUNT:RESET clears the Min Hold, Max Hold, or Min/Max Hold data and counter, and restarts the process for Trace 1 (and Trace 2 if enabled).

## TRACe<x>:SPECTrum:DETection

Sets or queries the algorithm used to decimate (decrease) the raw acquisition data down to a reasonable number of measurement points. Each spectrum waveform point corresponds to a frequency range, or bin, within the measurement span. When the spectrum analysis results in multiple points per bin, the detector setting determines how the multiple points are condensed to the single output waveform point for that bin.

This command is ignored and an error event generated when the instrument is not in the Spectrum measurement mode.

The Trace parameter <x> = 1 or 2.

---

**NOTE.** *This command applies to both Trace 1 and Trace 2. Therefore setting the Trace 1 detector mode also sets the Trace 2 detector mode.*

---

<b>Conditions</b>	Measurement modes: Spectrum
<b>Group</b>	Trace commands
<b>Syntax</b>	TRACe<x>:SPECTrum:DETEction { AVERAge   POSitive   NEGative } TRACe<x>:SPECTrum:DETEction?
<b>Arguments</b>	AVERAge displays the average data value for each bin. POSitive displays the maximum (positive peak) data value for each bin. NEGative displays the minimum (negative peak) data value for each bin.
<b>Examples</b>	TRACE1:SPECTRUM:DETECTION POSitive displays the maximum data value for each bin of Trace 1 (and Trace 2 if enabled).

## TRACe<x>:SPECTrum:FOReground

Sets or queries the foreground status of the specified Spectrum measurement trace.

This command is ignored and an error event generated when the instrument is not in the Spectrum measurement mode or the specified trace is disabled.

The Trace parameter <x> = 1 to 5; All traces are valid.

<b>Conditions</b>	Measurement modes: Spectrum
<b>Group</b>	Trace commands
<b>Syntax</b>	TRACe<x>:SPECTrum:FOReground { OFF   ON   0   1 } TRACe<x>:SPECTrum:FOReground?
<b>Arguments</b>	ON or 1 sets the specified trace to be the front-most trace. OFF or 0 sets the front-most trace to the next available enabled trace.
<b>Examples</b>	TRACE3:SPECTRUM:FOREGROUND ON sets Trace 3 as the front-most trace in the Spectrum measurement view.

## TRACe<x>:SPECtrum:FUNCtion

Sets or queries the function for the specified trace in the Spectrum view.

This command is ignored and an error event generated when the instrument is not in the Spectrum measurement mode or when the specified trace is not enabled.

The Trace parameter <x> = 1 and 2.

<b>Conditions</b>	Measurement modes: Spectrum
<b>Group</b>	Trace commands
<b>Syntax</b>	<pre>TRACe&lt;x&gt;:SPECtrum:FUNCtion { NORMAl   AVERAge   MAXHOld   MINHOld   BOTH } TRACe&lt;x&gt;:SPECtrum:FUNCtion?</pre>
<b>Arguments</b>	<p><b>NORMAl</b> selects the normal spectrum display.</p> <p><b>AVERAge</b> selects the Average display to show the average signal level at each frequency point.</p> <p><b>MAXHOld</b> selects the Max Hold display to show the maximum signal level at each frequency point.</p> <p><b>MINHOld</b> selects the Min Hold display to show the minimum signal level at each frequency point.</p> <p><b>BOTH</b> selects the Min Hold display to show both the maximum and minimum signal levels at each frequency point.</p>
<b>Examples</b>	<pre>TRACE2:SPECTRUM:FUNCTION MAXHOld</pre> <p>selects the Trace 2 waveform to show the maximum signal level at each frequency point in the Spectrum measurement view.</p>

## TRACe<x>:SPECtrum:LEFToperand

Sets or queries the left operand for the math trace (Trace 5) in the Spectrum view.

This command is ignored and an error event generated when the instrument is not in the Spectrum measurement mode or when a specified trace is not enabled.

The Trace parameter <x> = 5.

<b>Conditions</b>	Measurement modes: Spectrum
-------------------	-----------------------------

<b>Group</b>	Trace commands
<b>Syntax</b>	TRACe<x>:SPECTrum:LEFToperand { TRACE1   TRACE2   TRACE3   TRACE4 } TRACe<x>:SPECTrum:LEFToperand?
<b>Related Commands</b>	<a href="#">TRACe&lt;x&gt;:SPECTrum:OPERation</a> <a href="#">TRACe&lt;x&gt;:SPECTrum:RIGHtooperand</a>
<b>Arguments</b>	TRACE1 selects Trace 1 as the left operand for the math trace. TRACE2 selects Trace 2 as the left operand for the math trace. TRACE3 selects Trace 3 as the left operand for the math trace. TRACE4 selects Trace 4 as the left operand for the math trace.
<b>Examples</b>	TRACE5: SPECTRUM: LEFTOPERAND TRACE1 selects Trace 1 as the left operand for the math trace.

## TRACe<x>:SPECTrum:LOAD:TRACe (No Query Form)

Loads the specified Spectrum measurement waveform trace into the Ref A or Ref B waveform traces.

This command is ignored and an error event generated when the instrument is not in the Spectrum measurement mode, when a specified trace (source or destination) is not enabled, or the specified source and destination traces are the same.

The Trace parameter <x> = 3 (Ref A) or 4 (Ref B).

<b>Conditions</b>	Measurement modes: Spectrum
<b>Group</b>	Trace commands
<b>Syntax</b>	TRACe<x>:SPECTrum:LOAD:TRACe { TRACE1   TRACE2   TRACE3   TRACE4   TRACE5 }
<b>Arguments</b>	TRACE1 loads the specified Spectrum measurement reference trace with the contents of trace 1.  TRACE2 loads the specified Spectrum measurement reference trace with the contents of trace 2.



TRACe3 loads the specified Spectrum measurement reference trace with the contents of trace 3.

TRACe4 loads the specified Spectrum measurement reference trace with the contents of trace 4.

TRACe5 loads the specified Spectrum measurement reference trace with the contents of trace 5.

**Examples** TRACe4:SPECTRUM:LOAD:TRACE TRACE1 loads Trace 1 waveform data into the Spectrum waveform Trace 4 (Ref B).

## TRACe<x>:SPECTrum:OPERation

Sets or queries the math operation to perform on the Spectrum mode Math trace.

This command is ignored and an error event generated when the instrument is not in the Spectrum measurement mode.

The Trace parameter <x> = 5 (Math trace)

**Conditions** Measurement modes: Spectrum

**Group** Trace commands

**Syntax** TRACe<x>:SPECTrum:OPERation { MINus | PLUS }  
TRACe<x>:SPECTrum:OPERation?

**Related Commands** [TRACe<x>:SPECTrum:LEFToperand](#)  
[TRACe<x>:SPECTrum:RIGHToperand](#)

**Arguments** MINus sets the math trace operation to subtract two traces.

PLUS sets the math trace operation to add two traces.

**Examples** TRACe5:SPECTRUM:OPERATION MINUS sets the math trace operation to subtract two traces.

## TRACe<x>:SPECTrum:RIGHToperand

Sets or queries the right operand for the math trace (Trace 5) in the Spectrum measurement.

This command is ignored and an error event generated when the instrument is not in the Spectrum measurement mode or when a specified trace is not enabled.

The Trace parameter <x> = 5.

<b>Conditions</b>	Measurement modes: Spectrum
<b>Group</b>	Trace commands
<b>Syntax</b>	TRACe<x>:SPECTrum:RIGHToperand { TRACe1   TRACe2   TRACe3   TRACe4 } TRACe<x>:SPECTrum:RIGHToperand?
<b>Related Commands</b>	<a href="#">TRACe&lt;x&gt;:SPECTrum:LEFToperand</a> <a href="#">TRACe&lt;x&gt;:SPECTrum:OPERation</a>
<b>Arguments</b>	TRACe1 selects Trace 1 as the right operand for the math trace. TRACe2 selects Trace 2 as the right operand for the math trace. TRACe3 selects Trace 3 as the right operand for the math trace. TRACe4 selects Trace 4 as the right operand for the math trace.
<b>Examples</b>	TRACE5 : SPECTRUM : RIGHTOPERAND TRACE2 selects Trace 2 as the right operand for the math trace.

## \*TRG (No Query Form)

Generates a trigger. It produces the same effect as tapping the UI trigger tab "Force Trigger" button. This command is valid when the trigger mode is Triggered. In cases where the acquisition has been started but is currently waiting for the trigger event, issuing this command immediately forces the trigger event to occur.

<b>Conditions</b>	Measurement modes: All
<b>Group</b>	IEEE common commands
<b>Syntax</b>	*TRG
<b>Related Commands</b>	<a href="#">TRIGger[:SEquence]:STATus</a>

**Arguments** None

**Examples** \*TRG generates a trigger.

## TRIGger[:SEquence]:EVENT:EXTernal:SLOPe

Sets or queries the trigger slope of the external trigger input.

**Conditions** Measurement modes: All

**Group** Trigger commands

**Syntax** TRIGger[:SEquence]:EVENT:EXTernal:SLOPe { RISE | FALL | HIGH  
| LOW }  
TRIGger[:SEquence]:EVENT:EXTernal:SLOPe?

**Arguments** RISE causes the trigger event on the rising edge.  
FALL causes the trigger event on the falling edge.  
HIGH causes the trigger event on a logic high.  
LOW causes the trigger event on a logic low.

**Examples** TRIGGER:SEQUENCE:EVENT:EXTERNAL:SLOPE RISE causes a trigger event on the rising edge of the external trigger input.

## TRIGger[:SEquence]:EVENT:INPut:LEVel

Sets or queries the IF trigger level.

**Conditions** Measurement modes: All

**Group** Trigger commands

**Syntax** TRIGger[:SEquence]:EVENT:INPut:LEVel <value>  
TRIGger[:SEquence]:EVENT:INPut:LEVel?

**Arguments** <value>::=<Nrf> specifies the IF level trigger threshold. The threshold value uses the current power units.

**Examples** TRIGGER:SEQUENCE:EVENT:INPUT:LEVEL -10 sets the IF trigger threshold level to -10.

## TRIGger[:SEQuence]:EVENT:INPut:SLOPe

Sets or queries the IF trigger slope type.

**Conditions** Measurement modes: All

**Group** Trigger commands

**Syntax** TRIGger[:SEQuence]:EVENT:INPut:SLOPe { RISE | FALL | HIGH | LOW }  
TRIGger[:SEQuence]:EVENT:INPut:SLOPe?

**Arguments** RISE causes the IF trigger event on the rising edge.  
FALL causes the IF trigger event on the falling edge.  
HIGH causes the IF trigger event on a logic high.  
LOW causes the IF trigger event on a logic low.

**Examples** TRIGGER:SEQUENCE:EVENT:INPUT:SLOPE RISE causes the IF trigger event on the rising edge of the signal.

## TRIGger[:SEQuence]:EVENT:INTernal

Sets or queries the internal time base trigger mode.

**Conditions** Measurement modes: All

**Group** Trigger commands

**Syntax** TRIGger[:SEQuence]:EVENT:INTernal {TIME | INTerval | BOTH }  
TRIGger[:SEQuence]:EVENT:INTernal?

<b>Related Commands</b>	TRIGger[:SEquence]:EVENT:INTernal:REPeat TRIGger[:SEquence]:EVENT:INTernal:TIME
<b>Arguments</b>	TIME sets the internal time base trigger mode to trigger at a specific time. INTerval sets the internal time base trigger mode to trigger at a specific interval. BOTH sets the internal time base trigger mode to trigger at a specific time and interval.
<b>Examples</b>	TRIGGER:SEQUENCE:EVENT:INTERNAL TIME sets the internal time base trigger mode to trigger at a specific time.

## TRIGger[:SEquence]:EVENT:INTernal:REPeat

Sets or queries the internal time base trigger repeat interval time.

This command is ignored and an error event generated when the seconds parameter is less than 10 ms or greater than 600 seconds.

<b>Conditions</b>	Measurement modes: All
<b>Group</b>	Trigger commands
<b>Syntax</b>	TRIGger[:SEquence]:EVENT:INTernal:REPeat <seconds> TRIGger[:SEquence]:EVENT:INTernal:REPeat?
<b>Arguments</b>	<seconds>: :=<Nrf> sets the internal time base trigger repeat interval time, in seconds. This value is rounded to the nearest 1 $\mu$ s boundary.
<b>Examples</b>	TRIGGER:SEQUENCE:EVENT:INTERNAL:REPEAT 300 sets the internal time base trigger repeat interval time to 300 seconds.

## TRIGger[:SEquence]:EVENT:INTernal:TIME

Sets or queries the internal time base trigger start time.

This command is ignored and an error event generated when the time parameter values are not standard hour, minute, or second values.

<b>Conditions</b>	Measurement modes: All
-------------------	------------------------

<b>Group</b>	Trigger commands
<b>Syntax</b>	TRIGger[:SEquence]:EVENT:INTERNAL:TIME <hour>, <minute>, <seconds> TRIGger[:SEquence]:EVENT:INTERNAL:TIME?
<b>Arguments</b>	<p>&lt;hour&gt; ::= &lt;NRf&gt; sets the hour portion of the internal time base trigger start time. This value is rounded to the nearest hour boundary.</p> <p>&lt;minutes&gt; ::= &lt;NRf&gt; sets the minute portion of the internal timebase trigger start time. This value is rounded to the nearest minute boundary.</p> <p>&lt;seconds&gt; ::= &lt;NRf&gt; sets the seconds portion of the internal timebase trigger start time. This value is rounded to the nearest 1<math>\mu</math>s boundary.</p>
<b>Examples</b>	TRIGGER:SEQUENCE:EVENT:INTERNAL:TIME 14,33,00 sets the internal time base trigger start time to 2:33 PM.

## TRIGger[:SEquence]:EVENT:SOURce

Sets or queries the trigger event source.

This command is ignored and an error event generated when the current instrument settings constrain triggering to just free-run mode.

<b>Conditions</b>	Measurement modes: All
<b>Group</b>	Trigger commands
<b>Syntax</b>	TRIGger[:SEquence]:EVENT:SOURce { INPUT   EXTERNAL   INTERNAL } TRIGger[:SEquence]:EVENT:SOURce?
<b>Related Commands</b>	<a href="#">TRIGger[:SEquence]:STATus</a>

**Arguments** The following table lists the arguments.

**Table 2-27: Trigger event source**

Argument	Source
INPut	IF level input
EXternal	External input
INternal	Internal time base input.

**Examples** TRIGGER:SEQUENCE:EVENT:SOURCE INPUT sets the trigger event source as the IF level input.

## TRIGger[:SEQuence]:IMMediate (No Query Form)

Forces a trigger immediately, skipping the event detection. This command is valid when TRIGger[:SEQuence]:STATus is set to On (the trigger mode is Triggered).

In cases where the acquisition has been started but is currently waiting for the trigger event, issuing this command immediately forces the trigger event to occur. In cases where an acquisition is not currently waiting for the trigger event, this command effectively performs no operation.

This command is ignored and an error event generated when the current instrument settings constrain triggering to just free-run mode.

**Conditions** Measurement modes: All

**Group** Trigger commands

**Syntax** TRIGger[:SEQuence]:IMMediate

**Arguments** None

**Examples** TRIGGER:SEQUENCE:IMMEDIATE causes a trigger immediately, skipping the event detection and delay.

## TRIGger[:SEQuence]:STATus

Sets or queries the trigger mode (Free Run or Triggered).

This command is ignored and an error event generated when the current instrument settings constrain triggering to just free-run mode.

<b>Conditions</b>	Measurement modes: All
<b>Group</b>	Trigger commands
<b>Syntax</b>	TRIGger[:SEQuence]:STATus { OFF   ON   0   1 } TRIGger[:SEQuence]:STATus?
<b>Related Commands</b>	<a href="#">TRIGger[:SEQuence]:EVENT:SOURce</a>
<b>Arguments</b>	OFF or 0 selects free-run mode. ON or 1 selects triggered mode.
<b>Examples</b>	TRIGGER:SEQUENCE:STATUS ON selects the triggered mode.

## TRIGger[:SEQuence]:TIME:DELAy

Sets or queries the trigger delay time (after recognizing the event but before actually declaring the trigger).

<b>Conditions</b>	Measurement modes: All
<b>Group</b>	Trigger commands
<b>Syntax</b>	TRIGger[:SEQuence]:TIME:DELAy <value> TRIGger[:SEQuence]:TIME:DELAy?
<b>Arguments</b>	<value> ::= <NRF> specifies the trigger delay time in seconds. Range: 0 to 60 seconds. The value is rounded to the nearest 1 ns boundary.
<b>Examples</b>	TRIGGER:SEQUENCE:TIME:DELAy 1.5 sets the trigger delay time to 1.5 seconds.

## UNIT:POWer

Sets or queries the amplitude power units. This command is equivalent to [\[SENSe\]:POWer:UNITs](#).



This command is ignored and an error event generated if you issue a VOLTS or WATTS argument while in the DPX Spectrum measurement mode.

<b>Conditions</b>	Measurement modes: All
<b>Group</b>	Unit commands
<b>Syntax</b>	UNIT:POWER { DBM   DBV   VOLTS   WATTS   DBW  DBUV   DBMV } UNIT:POWER?

**Arguments** The following table lists the arguments.

**Table 2-28: Power units**

Argument	Power unit
DBM	dBm
DBV	dBV
VOLTS	Volts
WATTS	Watts
DBW	dBW
DBUV	dB $\mu$ V
DBMV	dBmV

**NOTE.** *The DPX Spectrum measurements do not support VOLTS or WATTS units.*

**Examples** UNIT:POWER DBM specifies the measurement unit of power as dBm.

## \*WAI (No Query Form)

Prevents the instrument from executing further commands or queries until all pending operations finish. This command allows you to synchronize the operation of the instrument with your application program. For the details, refer to *Synchronizing Execution* (See page 3-7.).

<b>Conditions</b>	Measurement modes: All
<b>Group</b>	IEEE common commands

**Syntax**    \*WAI

**Related Commands**    \*OPC

**Arguments**    None

---

# Status and Events



# Status and Events

The SCPI interface in the instrument includes a status and event reporting system that enables the user to monitor crucial events that occur in the instrument. The instrument is equipped with four registers and one queue that conform to IEEE Std 488.2-1987. This section will discuss these registers and queues along with status and event processing.

## Status and Event Reporting System

The following figure outlines the status and event reporting mechanism offered in the H500 and SA2500 instruments.

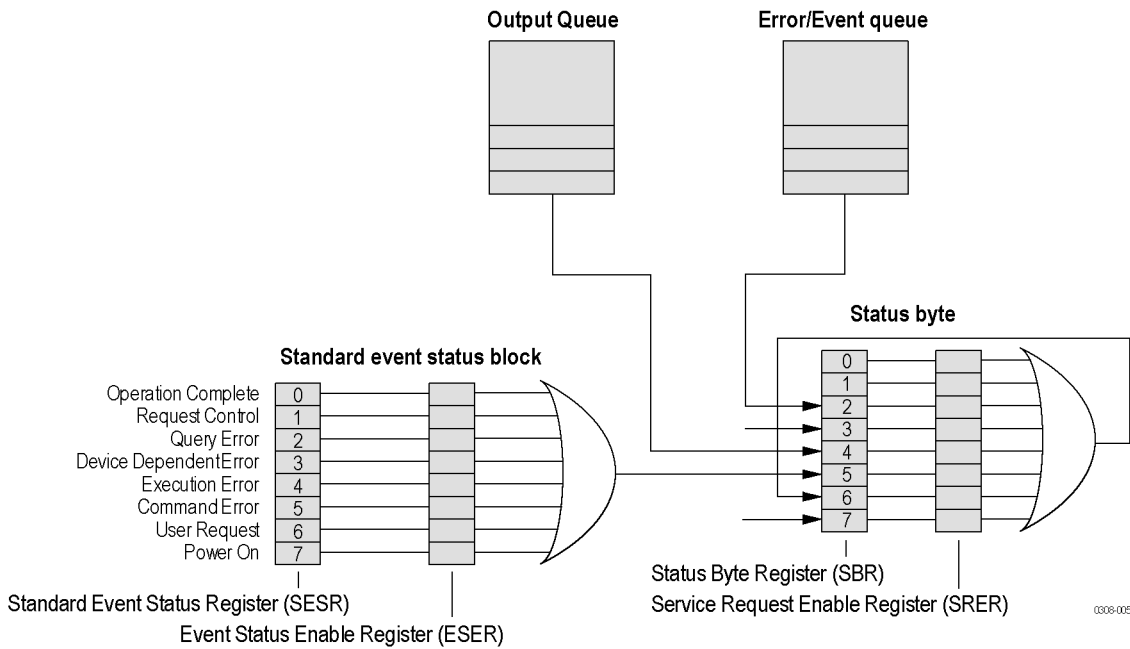

Figure 3-1: Status/Event reporting mechanism

## Status Byte

The Status Byte contains the following two registers

- Status Byte Register (SBR)
- Service Request Enable Register (SRER)

### Status Byte Register (SBR)

The SBR is made up of 8 bits. Bits 4, 5 and 6 are defined in accordance with IEEE Std 488.2-1987. These bits are used to monitor the output queue, SESR and

master status summary, respectively. The contents of this register are returned when the \*STB? query is used.

7	6	5	4	3	2	1	0
—	MSS	ESB	MAV	—	—	—	—

0008-006

**Figure 3-2: Status Byte Register (SBR)**

**Table 3-1: SBR bit functions**

Bit	Description
7	Not used.
6	Master Status Summary (MSS) bit. Indicates that the instrument has issued a service request for one or more reasons. The MSS bit is never cleared to 0 by the *STB? query.
5	Event Status Bit (ESB). This bit indicates whether or not a new event has occurred after the previous Standard Event Status Register (SESR) has been cleared or after an event readout has been performed.
4	Message Available Bit (MAV). This bit indicates that a message has been placed in the output queue and can be retrieved.
3-0	Not used.

**Service Request Enable Register (SRER)**

The SRER is made up of bits defined exactly the same as bits 0 through 7 in the SBR as shown in the following figure. This register is used by the user to determine which events will set the MSS bit of the SBR.

The SRER bit 6 cannot be set.

Use the \*SRE command to set the bits of the SRER. Use the \*SRE? query to read the contents of the SRER. Bit 6 must be set to 0.

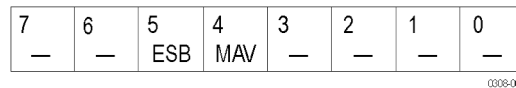

**Figure 3-3: Service Request Enable Register (SRER)**

## Standard Event Status Block

Reports errors and operation complete status. It consists of the following registers

- Standard Event Status Register (SESR)
- Event Status Enable Register (ESER)

These registers are made up of the same bits defined in the following figure and table. Use the \*ESR? query to read the contents of the SESR. Use the \*ESE() command to access the ESER.

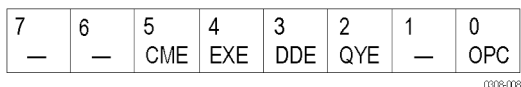

**Figure 3-4: Standard event status register**

**Table 3-2: Standard event status register bit definition**

Bit	Description
7	Not used.
6	Not used.
5	Command Error (CME). Indicates that a command error has occurred while parsing by the command parser was in progress.
4	Execution Error (EXE). Indicates that an error occurred during the execution of a command. Execution errors occur for one of the following reasons: <ul style="list-style-type: none"> <li>■ When a value designated in the argument is outside the allowable range of the instrument, or is in conflict with the capabilities of the instrument.</li> <li>■ When the command could not be executed properly because the conditions for execution differed from those essentially required.</li> </ul>
3	Device-Dependent Error (DDE). An instrument error has been detected.
2	Query Error (QYE). Indicates that a query error has been detected by the output queue controller. Query errors occur for one of the following reasons: <ul style="list-style-type: none"> <li>■ An attempt was made to retrieve messages from the output queue, despite the fact that the output queue is empty or in pending status.</li> <li>■ The output queue messages have been cleared despite the fact that they have not been retrieved.</li> </ul>
1	Not used.
0	Operation Complete (OPC). This bit is set with the results of the execution of the *OPC command. It indicates that all pending operations have been completed.

When an event occurs, the SESR bit corresponding to the event is set, resulting in the event being stacked in the Error/Event Queue. If the bit corresponding to the event has also been set in the ESER, the SBR ESB bit is also set. When a message is sent to the Output Queue, the SBR MAV bit is set.



## Queues

There are two types of queues in the status reporting system used in the instrument: output queues and event queues.

**Output Queue** The output queue is a FIFO (first in, first out) queue and holds response messages to queries, where they await retrieval. When there are messages in the queue, the SBR MAV bit is set.

The output queue will be emptied each time a command or query is received, so the controller must read the output queue before the next command or query is issued. If this is not done, an error will occur and the output queue will be emptied; however, the operation will proceed even if an error occurs.

**Event Queue** The event queue is a FIFO queue and stores events as they occur in the instrument. If more than 32 events occur, event 32 will be replaced with event code -350 ("Queue Overflow"). The error code and text are retrieved using the SYSTem:ERRor queries.

## Status and Event Processing Sequence

The following figure shows an outline of the sequence for status and event processing.

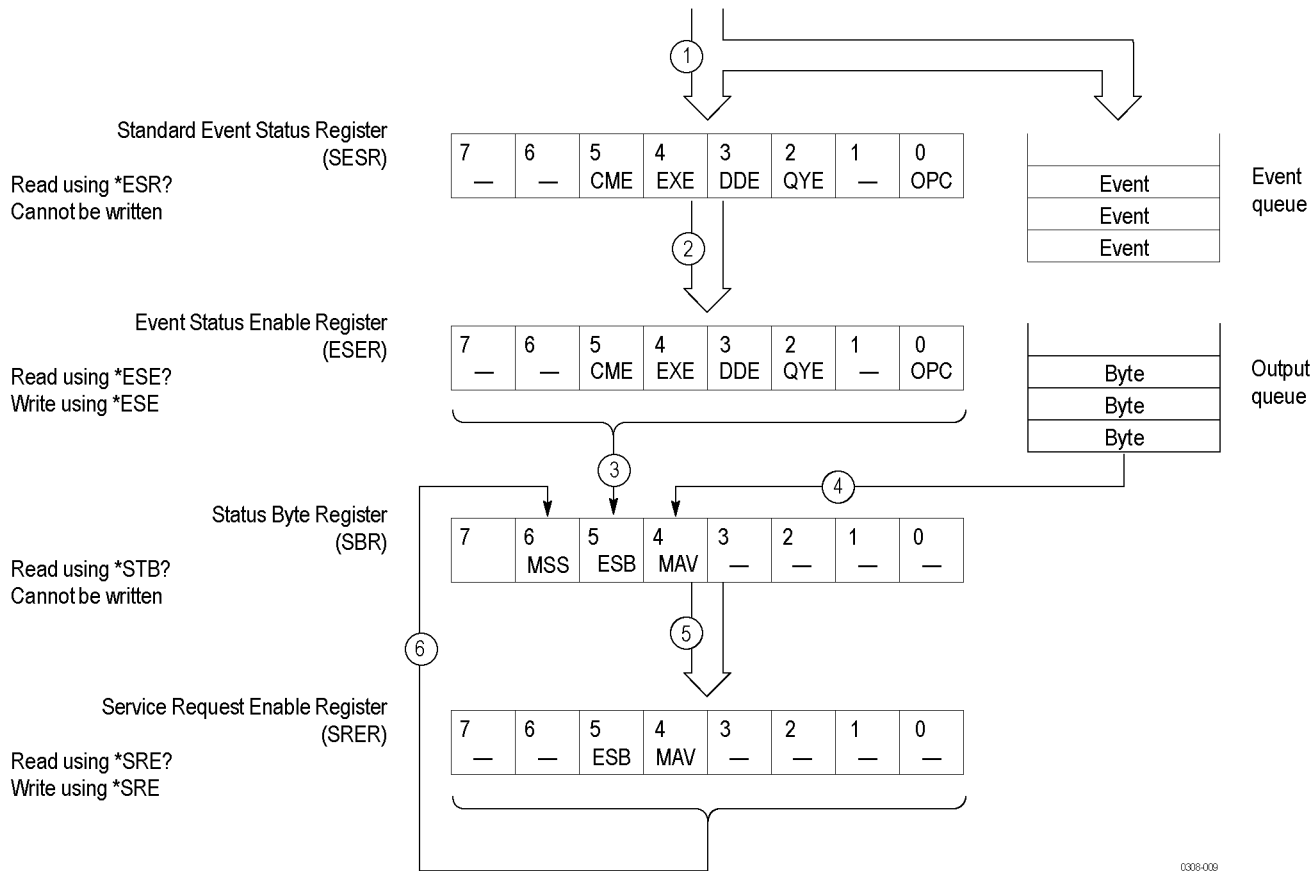

0308-009

Figure 3-5: Status and event processing sequence

1. If an event has occurred, the SESR bit corresponding to that event is set and the event is placed in the event queue.
2. A bit corresponding to that event in the ESER has is set.
3. The SBR ESB bit is set to reflect the status of the ESER.
4. When a message is sent to the output queue, the SBR MAV bit is set.
5. Setting either the ESB or MAV bits in the SBR sets the respective bit in the SRER.
6. When the SRER bit is set, the SBR MSS bit is set.

## Synchronizing Execution

Almost all commands are executed in the order in which they are sent from the controller, and the execution of each command is completed in a short period of time. However, the INITiate[:IMMEDIATE] command performs data analysis in another thread, and another command can thus be executed concurrently.

This command is designed so that the next command to be sent is executed without waiting for the previous command to be completed. In some cases, a process executed by another command must first be completed before this command can be executed; in other cases, this command must be completed before the next command is executed.

To achieve synchronization, the IEEE-488.2 common commands include the following commands:

- \*OPC
- \*OPC?
- \*WAI

**Using the \*OPC command.** The \*OPC command sets the SESR OPC bit when all the operations for which it is waiting are completed. You can synchronize the execution by using this command together with the serial polling function.

The following is a command sequence example:

```
*ESE 1
  // Enable the ESER OPC bit
ABORT;INITiate:IMMEDIATE;*OPC
  // Wait for the ESB bit of the SESR to be set to provide synchronization
```

**Using the \*OPC? query.** The query \*OPC? writes ASCII code "1" into the Output Queue when all operations for which it is waiting are completed. You can provide synchronization using the command string as the following example:

```
ABORT;INITiate:IMMEDIATE;*OPC?
  // Wait for the *OPC? query response to provide synchronization
```

The command waits until "1" is written into the Output Queue. When the command goes to the Output Queue to read the data, a time-out may occur before the data is written into the queue.

**Using the \*WAI Command.** After the process of the preceding command is completed, the \*WAI command begins to execute the process of the next command as the following example:

```
ABORT;INITiate:IMMEDIATE;*WAI
  // Wait for the *WAI process to provide synchronization
```

## Error Messages and Codes

Error codes with a negative value are SCPI standard error codes; errors with a positive value are unique to the H500 and SA2500 instruments.

Event codes and messages can be obtained by using the queries `SYSTEM:ERROR?` and `SYSTEM:ERROR:ALL?` These are returned in the following format:

```
<event_code>,"<event_message>"
```

## Command Errors

Command errors are returned when there is a syntax error in the command.

**Table 3-3: Command errors**

<b>Error code</b>	<b>Error message</b>
-100	Command error
-101	Invalid character
-102	Syntax error
-103	Invalid separator
-104	Data type error
-105	GET not allowed
-108	Parameter not allowed
-109	Missing parameter
-110	Command header error
-111	Header separator error
-112	Program mnemonic too long
-113	Undefined header
-114	Header suffix out of range
-120	Numeric data error
-121	Character
-123	Exponent too large
-124	Too many digits
-128	Numeric data not allowed
-130	Suffix error
-131	Invalid suffix
-134	Suffix too long
-138	Suffix not allowed
-140	Character data error
-141	Invalid character data
-144	Character data too long

**Table 3-3: Command errors (cont.)**

<b>Error code</b>	<b>Error message</b>
-148	Character data not allowed
-150	String data error
-151	Invalid string data
-158	String data not allowed
-160	Block data error
-161	Invalid block data
-168	Block data not allowed
-170	Command expression error
-171	Invalid expression
-178	Expression data not allowed
-180	Macro error
-181	Invalid outside macro definition
-183	Invalid inside macro definition
-184	Macro parameter error

## Execution Errors

These error codes are returned when an error is detected while a command is being executed.

**Table 3-4: Execution errors**

<b>Error code</b>	<b>Error message</b>
-200	Execution error
-201	Invalid while in local
-202	Settings lost due to RTL
-210	Trigger error
-211	Trigger ignored
-212	Arm ignored
-213	Init ignored
-214	Trigger deadlock
-215	Arm deadlock
-220	Parameter error
-221	Settings conflict
-222	Data out of range
-223	Too much data
-224	Illegal parameter value
-225	Out of memory

**Table 3-4: Execution errors (cont.)**

<b>Error code</b>	<b>Error message</b>
-226	Lists not same length
-230	Data corrupt or stale
-231	Data questionable
-240	Hardware error
-241	Hardware missing
-250	Mass storage error
-251	Missing mass storage
-252	Missing media
-253	Corrupt media
-254	Media full
-255	Directory full
-256	Filename not found
-257	Filename error
-258	Media protected
-260	Execution expression error
-261	Math error in expression
-270	Execution macro error
-271	Macro syntax error
-272	Macro execution error
-273	Illegal macro label
-274	Execution macro parameter error
-275	Macro definition too long
-276	Macro recursion error
-277	Macro redefinition not allowed
-278	Macro header not found
-280	Program error
-281	Cannot create program
-282	Illegal program name
-283	Illegal variable name
-284	Program currently running
-285	Program syntax error
-286	Program runtime error

## Device Specific Errors

These error codes are returned when an internal instrument error is detected. This type of error may indicate a hardware problem.

**Table 3-5: Device specific errors**

<b>Error code</b>	<b>Error message</b>
-300	Device specific error
-310	System error
-311	Memory error
-312	PUD memory lost
-313	Calibration memory lost
-314	Save/Recall memory lost
-315	Configuration memory lost
-330	Self test failed
-350	Queue overflow

## Query Errors

These error codes are returned in response to an unanswered query.

**Table 3-6: Query errors**

<b>Error code</b>	<b>Error message</b>
-400	Query error
-410	Query interrupted
-420	Query untermiated
-430	Query deadlocked
-440	Query untermiated after indefinite period

## Status Conditions

Status conditions do not appear in the event queue; they are only returned by the :STATus:<measurement>:EVENTs query. The following table lists the status codes and messages:

**Table 3-7: Status command codes and messages**

<b>Status code</b>	<b>Status message</b>
0	No events to report
12000	Data acquired during RF ADC overrange
12001	Input signal power too high
12002	Instrument paused to reduce internal temperature
12005	Normalization in progress
12007	Normalization failed
12008	Data from uncalibrated settings
12009	Data from uncalibrated instrument



---

# Appendices



# Appendix A: Character Charts

B7 B6 B5 BITS B4 B3 B2 B1	0 0		0 0 1		0 1 0		0 1 1		1 0 0		1 0 1		1 1 0		1 1 1	
	CONTROL				NUMBERS SYMBOLS				UPPER CASE				LOWER CASE			
0 0 0 0	0	NUL	20	DLE	40	SP	60	0	100	@	120	P	140	,	160	p
0 0 0 1	1	GTL SOH	21	LL0 DC1	41	!	61	1	101	A	121	Q	141	a	161	q
0 0 1 0	2	STX	22	DC2	42	"	62	2	102	B	122	R	142	b	162	r
0 0 1 1	3	ETX	23	DC3	43	#	63	3	103	C	123	S	143	c	163	s
0 1 0 0	4	SDC EOT	24	DCL DC4	44	\$	64	4	104	D	124	T	144	d	164	t
0 1 0 1	5	PPC ENQ	25	PPU NAK	45	%	65	5	105	E	125	U	145	e	165	u
0 1 1 0	6	ACK	26	SYN	46	&	66	6	106	F	126	V	146	f	166	v
0 1 1 1	7	BEL	27	ETB	47	'	67	7	107	G	127	W	147	g	167	w
1 0 0 0	8	GET BS	30	SPE CAN	50	(	70	8	110	H	130	X	150	h	170	x
1 0 0 1	9	TCT HT	31	SPD EM	51	)	71	9	111	I	131	Y	151	i	171	y
1 0 1 0	10	LF	32	SUB	52	*	72	:	112	J	132	Z	152	j	172	z
1 0 1 1	11	VT	33	ESC	53	+	73	;	113	K	133	[	153	k	173	{
1 1 0 0	12	FF	34	FS	54	,	74	<	114	L	134	\	154	l	174	
1 1 0 1	13	CR	35	GS	55	-	75	=	115	M	135	]	155	m	175	}
1 1 1 0	14	SO	36	RS	56	.	76	>	116	N	136	^	156	n	176	~
1 1 1 1	15	SI	37	US	57	/	77	?	117	O	137	_	157	o	177	RUBOUT (DEL)
	ADDRESSED COMMANDS		UNIVERSAL COMMANDS		LISTEN ADDRESSES				TALK ADDRESSES				SECONDARY ADDRESSES OR COMMANDS			

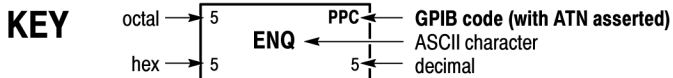

**Tektronix**  
 REF: ANSI STD X3.4-1977  
 IEEE STD 488.1-1987  
 ISO STD 646-2973



# Appendix B: SCPI Conformance Information

All commands for the H500 and SA2500 instruments are based on SCPI Version 1999.0. The following table lists the commands that are defined in the SCPI 1999.0 Standard. The other commands not listed in the table are not defined in the SCPI 1999.0 Standard.

**Table B-1: SCPI 1999.0-defined commands**

Command group	Command	
IEEE common	*CAL	
	*CLS	
	*ESE	
	*ESR	
	*IDN	
	*OPC	
	*RST	
	*SRE	
	*STB	
	*TRG	
*WAI		
ABORt	:ABORt	
INITiate	:INITiate	
	:CONTinuous [:IMMediate]	
SYSTem	:SYSTem	
	:DATE?	
	:ERRor	:COUNT? [:NEXT]?
	:TIME?	
UNIT	:UNIT	:POWer



---

# Appendix C: Sample Source Code

## C++ Sample Code

The following source code uses the Win32 Winsock library to interface to the H500 or SA2500. The following modules are included:

- **C\_PILib.cpp** and **C\_PILib.h**: Library modules that encapsulate the TCP/IP interface to a minimal set of routines for communication with the H500 or SA2500 programmable interface.
- **C\_PILibTest.cpp**: A H500 or SA2500 demo program that shows how to use the majority of the interface functions in the C\_PILib library
- **C\_PILib.sln/vcproj**: Microsoft Visual Studio 2008 solution and project files for building the C\_PILib library.
- **C\_PILibTest.sln/vcproj**: Microsoft Visual Studio 2008 solution and project files for building the C\_PILib library and the demo program.

These files are attached to this PDF document. Click the **Attachments** (paperclip) button in Adobe Reader to show the list of files. You can drag and drop these files onto your PC desktop.

## MATLAB Sample Code

The following MATLAB code uses the MATLAB Instrument Control Toolbox plug-in to interface to the H500 or SA2500. This code is also attached to the PDF document as file *CommExample.m*.

```
%%  
  
%% CommExample -- Communication example for the  
%% H500/SA2500 v1.0  
%%  
  
%% This free software may not have gone through Tektronix  
%% normal quality control or production processes,  
%% but is provided to users as an accommodation to  
%% respond to user requests. The free software is provided  
%% hereunder on an AS-IS basis without any representation  
%% or warranty.  
  
%% TEKTRONIX DISCLAIMS ALL WARRANTIES, WHETHER EXPRESS OR  
%% IMPLIED, INCLUDING WARRANTIES OF MERCHANTABILITY,
```

```
%% FITNESS FOR A PARTICULAR PURPOSE, AND NON-
%% INFRINGEMENT OF INTELLECTUAL PROPERTY RIGHTS.
%% IN NO EVENT SHALL TEKTRONIX BE LIABLE FOR ANY DIRECT,
%% INDIRECT, SPECIAL, INCIDENTAL, OR CONSEQUENTIAL
%% DAMAGES IN ANY WAY ARISING OUT OF, OR CONNECTED WITH,
%% THE USE OF THIS FREE SOFTWARE.
%%
function CommExample()
TCPIPControlHandle = tcpip('192.68.0.80', 34835);
set(TCPIPControlHandle, 'InputBufferSize', 4096);
set(TCPIPControlHandle, 'Terminator', 10);
fopen(TCPIPControlHandle);
fprintf(TCPIPControlHandle, '*IDN?');
strResponse = fgetl(TCPIPControlHandle);
disp(['Instrument ID: ' strResponse]);
fclose(TCPIPControlHandle);
end
```



# Index

## A

ABORt, 2-31

## C

\*CAL?, 2-31

Calculate Commands, 2-13

CALCulate:AVTime:MARKer<x>:MAXimum, 2-32

CALCulate:AVTime:MARKer<x>:MODE, 2-32

CALCulate:AVTime:MARKer<x>:PEAK:

HIGHer, 2-33

CALCulate:AVTime:MARKer<x>:PEAK:LEFT, 2-34

CALCulate:AVTime:MARKer<x>:PEAK:

LOWer, 2-34

CALCulate:AVTime:MARKer<x>:PEAK:

RIGHt, 2-35

CALCulate:AVTime:MARKer<x>:STATe, 2-35

CALCulate:AVTime:MARKer<x>:TRACe, 2-36

CALCulate:AVTime:MARKer<x>:X, 2-37

CALCulate:AVTime:MARKer<x>:Y?, 2-37

CALCulate:DPSA:MARKer<x>[:SET]:CENTer, 2-42

CALCulate:DPSA:MARKer<x>:MAXimum, 2-38

CALCulate:DPSA:MARKer<x>:MODE, 2-39

CALCulate:DPSA:MARKer<x>:PEAK:HIGHer, 2-39

CALCulate:DPSA:MARKer<x>:PEAK:LEFT, 2-40

CALCulate:DPSA:MARKer<x>:PEAK:LOWer, 2-41

CALCulate:DPSA:MARKer<x>:PEAK:RIGHt, 2-41

CALCulate:DPSA:MARKer<x>:STATe, 2-42

CALCulate:DPSA:MARKer<x>:X, 2-43

CALCulate:DPSA:MARKer<x>:Y?, 2-44

CALCulate:MARKer:PEAK:THREshold, 2-44

CALCulate:SEARCh:LIMit:FAIL?, 2-45

CALCulate:SEARCh:LIMit:MATCh:BEEP[:

STATe], 2-46

CALCulate:SEARCh:LIMit:MATCh:SACQuire[:

STATe], 2-46

CALCulate:SEARCh:LIMit:MATCh:SPICture[:

STATe], 2-47

CALCulate:SEARCh:LIMit:MATCh:STRace[:

STATe], 2-47

CALCulate:SEARCh:LIMit:OPERation:MASK:

LOAD, 2-48

CALCulate:SEARCh:LIMit:STATe, 2-49

CALCulate:SPECTrum:MARKer<x>[:SET]:  
CENTer, 2-53

CALCulate:SPECTrum:MARKer<x>:

MAXimum, 2-49

CALCulate:SPECTrum:MARKer<x>:MODE, 2-50

CALCulate:SPECTrum:MARKer<x>:PEAK:

HIGHer, 2-50

CALCulate:SPECTrum:MARKer<x>:PEAK:

LEFT, 2-51

CALCulate:SPECTrum:MARKer<x>:PEAK:

LOWer, 2-52

CALCulate:SPECTrum:MARKer<x>:PEAK:

RIGHt, 2-52

CALCulate:SPECTrum:MARKer<x>:STATe, 2-53

CALCulate:SPECTrum:MARKer<x>:TRACe, 2-54

CALCulate:SPECTrum:MARKer<x>:X, 2-55

CALCulate:SPECTrum:MARKer<x>:Y?, 2-55

CALibration:AUTO, 2-56

CALibration:CORRection:EXTernal:GAIN[:

MAGNitude], 2-57

CALibration:CORRection:EXTernal:GAIN:

STATe, 2-57

\*CLS, 2-58

## D

DISPlay:AVTime:MARKer:SHOW:STATe, 2-59

DISPlay:AVTime:Y[:SCALe]:OFFSet, 2-60

DISPlay:AVTime:Y[:SCALe]:PDIVision, 2-60

DISPlay:DPSA:MARKer:SHOW:STATe, 2-58

DISPlay:GENeral:MEASview:NEW, 2-61

DISPlay:GENeral:MEASview:SElect, 2-61

DISPlay:SPECTrum:MARKer:SHOW:STATe, 2-62

DISPlay:SPECTrum:Y[:SCALe]:OFFSet, 2-62

DISPlay:SPECTrum:Y[:SCALe]:PDIVision, 2-63

## E

\*ESE, 2-63

\*ESR?, 2-64

## F

FETCh:AVTime:TRACe<x>?, 2-65

FETCh:DPSA:BITMap?, 2-65

FETCh:DPSA:TRACe1?, 2-67  
 FETCh:SPECTrum:TRACe<x>?, 2-68  
 FORMat:[DATA], 2-69  
 FORMat:[DATA]:LOGGing, 2-69

**I**

\*IDN?, 2-70  
 INITiate[:IMMediate], 2-71  
 INITiate:CONTinuous, 2-70  
 INPut[:RF]:ATTenuation, 2-72  
 INPut[:RF]:GAIN:STATe, 2-73  
 INPut:ALEVel, 2-72  
 INPut:RLEVel, 2-72

**M**

MMEMory:APPData:PREFix, 2-73  
 MMEMory:APPData:REsults, 2-74  
 MMEMory:APPData:REsults:DEFault:EXPort:  
   FORMat, 2-75  
 MMEMory:APPData:REsults:DEFault:SCREen:  
   FORMat, 2-75  
 MMEMory:APPData:REsults:DELeTe, 2-76  
 MMEMory:APPData:REsults:EXISts?, 2-76  
 MMEMory:APPData:REsults:INIT, 2-77  
 MMEMory:APPData:SETTings, 2-77  
 MMEMory:APPData:SETTings:DELeTe, 2-78  
 MMEMory:APPData:SETTings:EXISts?, 2-78  
 MMEMory:APPData:SETTings:INIT, 2-79  
 MMEMory:APPData:USERsettings, 2-79  
 MMEMory:APPData:USERsettings:DELeTe, 2-80  
 MMEMory:APPData:USERsettings:EXISts?, 2-80  
 MMEMory:APPData:USERsettings:INIT, 2-81  
 MMEMory:DELeTe, 2-81  
 MMEMory:EXISts?, 2-82  
 MMEMory:LOAD:REsults, 2-82  
 MMEMory:LOAD:STATe, 2-83  
 MMEMory:SPECTrum:LOAD:TRACe<x>, 2-84  
 MMEMory:STORe:IQ, 2-84  
 MMEMory:STORe:IQ:CSV, 2-85  
 MMEMory:STORe:IQ:MAT, 2-86  
 MMEMory:STORe:REsults, 2-87  
 MMEMory:STORe:SCREen, 2-88  
 MMEMory:STORe:STATe, 2-89

**O**

\*OPC, 2-90

OUTPut:IF[:STATe], 2-90  
 Overview of the Manual, 1-1

**R**

Related Documentation, iii  
 \*RST, 2-91

**S**

[SENSe]:AVTime:ACQuisition:MODE, 2-92  
 [SENSe]:AVTime:ACQuisition:RATE?, 2-92  
 [SENSe]:AVTime:ACQuisition:SAMPles, 2-93  
 [SENSe]:AVTime:ACQuisition:SEConds, 2-93  
 [SENSe]:AVTime:FREQuency:MEASurement, 2-94  
 [SENSe]:AVTime:FREQuency:SPAN, 2-94  
 [SENSe]:AVTime:MAX:SPAN, 2-95  
 [SENSe]:DPSA:CLear:REsults, 2-95  
 [SENSe]:DPSA:COLor, 2-96  
 [SENSe]:DPSA:COLor:MAXimum, 2-96  
 [SENSe]:DPSA:COLor:MINimum, 2-97  
 [SENSe]:DPSA:FREQuency:CENTer, 2-98  
 [SENSe]:DPSA:FREQuency:MEASurement, 2-98  
 [SENSe]:DPSA:FREQuency:SPAN, 2-99  
 [SENSe]:DPSA:MAX:SPAN, 2-99  
 [SENSe]:POWER:UNITs, 2-100  
 [SENSe]:ROSCillator:SOURce?, 2-101  
 [SENSe]:SPECTrum: {BANDwidth|BWIDth}[:  
   RESolution], 2-101  
 [SENSe]:SPECTrum: {BANDwidth|BWIDth}[:  
   RESolution]:AUTO, 2-102  
 [SENSe]:SPECTrum:FREQuency:CENTer, 2-102  
 [SENSe]:SPECTrum:FREQuency:  
   MEASurement, 2-103  
 [SENSe]:SPECTrum:FREQuency:SPAN, 2-104  
 [SENSe]:SPECTrum:FREQuency:SPAN:  
   BANDwidth[:RESolution]:RATio, 2-104  
 [SENSe]:SPECTrum:FREQuency:STARt, 2-105  
 [SENSe]:SPECTrum:FREQuency:STOP, 2-106  
 [SENSe]:SPECTrum:MAX:SPAN, 2-106  
 \*SRE, 2-107  
 STATus:AVTime:EVENTs?, 2-107  
 STATus:DPSA:EVENTs?, 2-108  
 STATus:SPECTrum:EVENTs?, 2-108  
 \*STB?, 2-109  
 SYSTem:COMMunicate:LOGGing:GPS[:SOCKeT]:  
   ADDRess, 2-110

SYSTem:COMMunicate:LOGGing:GPS[:SOCKEt]:  
   PORT, 2-110  
 SYSTem:COMMunicate:LOGGing:RESults[:  
   SOCKEt]:ADDReSS, 2-111  
 SYSTem:COMMunicate:LOGGing:RESults[:  
   SOCKEt]:PORT, 2-111  
 SYSTem:DATE?, 2-112  
 SYSTem:ERRor[:NEXT]?, 2-113  
 SYSTem:ERRor:COUNT?, 2-113  
 SYSTem:GPS, 2-114  
 SYSTem:GPS:POSition?, 2-114  
 SYSTem:GPS:STATus?, 2-115  
 SYSTem:LOGGing:GPS, 2-115  
 SYSTem:LOGGing:GPS:FILE[:NAME], 2-116  
 SYSTem:LOGGing:RESults, 2-117  
 SYSTem:LOGGing:RESults:FILE[:NAME], 2-117  
 SYSTem:TIME?, 2-118

## T

TRACe<x>:AVTime, 2-119  
 TRACe<x>:AVTime:AVERage:COUNT, 2-119  
 TRACe<x>:AVTime:AVERage:PROGress?, 2-120  
 TRACe<x>:AVTime:AVERage:RESet, 2-121  
 TRACe<x>:AVTime:COUNT:RESet, 2-121  
 TRACe<x>:AVTime:DETection, 2-122  
 TRACe<x>:AVTime:FOReground, 2-123  
 TRACe<x>:AVTime:FUNCTion, 2-123  
 TRACe<x>:DPSA:AVERage:COUNT, 2-124  
 TRACe<x>:DPSA:AVERage:PROGress?, 2-125  
 TRACe<x>:DPSA:AVERage:RESet, 2-125  
 TRACe<x>:DPSA:COLor:INTensity, 2-126  
 TRACe<x>:DPSA:COUNT:RESet, 2-126  
 TRACe<x>:DPSA:DETection, 2-127  
 TRACe<x>:DPSA:DOT:PERsistent, 2-127  
 TRACe<x>:DPSA:DOT:PERsistent:TYPE, 2-128

TRACe<x>:DPSA:DOT:PERsistent:VARiable, 2-129  
 TRACe<x>:DPSA:FUNCTion, 2-129  
 TRACe<x>:SPECTrum, 2-130  
 TRACe<x>:SPECTrum:AVERage:COUNT, 2-131  
 TRACe<x>:SPECTrum:AVERage:PROGress?, 2-131  
 TRACe<x>:SPECTrum:AVERage:RESet, 2-132  
 TRACe<x>:SPECTrum:COUNT:RESet, 2-133  
 TRACe<x>:SPECTrum:DETection, 2-133  
 TRACe<x>:SPECTrum:FOReground, 2-134  
 TRACe<x>:SPECTrum:FUNCTion, 2-135  
 TRACe<x>:SPECTrum:LEFTooperand, 2-135  
 TRACe<x>:SPECTrum:LOAD:TRACe, 2-136  
 TRACe<x>:SPECTrum:OPERation, 2-137  
 TRACe<x>:SPECTrum:RIGHToperand, 2-137  
 \*TRG, 2-138  
 TRIGger[:SEQuence]:EVENT:EXTernal:  
   SLOPe, 2-139  
 TRIGger[:SEQuence]:EVENT:INPut:LEVel, 2-139  
 TRIGger[:SEQuence]:EVENT:INPut:SLOPe, 2-140  
 TRIGger[:SEQuence]:EVENT:INTernal, 2-140  
 TRIGger[:SEQuence]:EVENT:INTernal:  
   REPeat, 2-141  
 TRIGger[:SEQuence]:EVENT:INTernal:TIME, 2-141  
 TRIGger[:SEQuence]:EVENT:SOURce, 2-142  
 TRIGger[:SEQuence]:IMMediate, 2-143  
 TRIGger[:SEQuence]:STATus, 2-143  
 TRIGger[:SEQuence]:TIME:DELay, 2-144

## U

UNIT:POWeR, 2-144

## W

\*WAI, 2-145