

Basic Characteristics Data

Model	Circuit method	Switching frequency [kHz]	Input current *1 [A]	Inrush current protection	PCB/Pattern			Series/Parallel operation availability	
					Material	Single sided	Double sided	Series operation	Parallel operation
GHA300F	boost chopper	60 - 220	3.3	Thermistor	FR-4		Yes	Yes	No
	LLC resonant converters	90 - 180							
GHA500F	boost chopper	60 - 220	5.4	Thermistor	Aluminum/FR-4	Yes	Yes	Yes	*2
	LLC resonant converters	90 - 180							
GHA500F-SNF	boost chopper	60 - 220	5.4	Thermistor	Aluminum/FR-4	Yes	Yes	Yes	*2
	LLC resonant converters	90 - 180							

*1 The value of input current is at ACIN 120V and rated load.

*2 Parallel operation is available with -P option. Refer to 5.1 on the instruction manual.

1	Function	GHA-10
1.1	Input voltage range	GHA-10
1.2	Inrush current limiting	GHA-10
1.3	Overcurrent protection	GHA-10
1.4	Overvoltage protection	GHA-10
1.5	Thermal protection	GHA-10
1.6	Output voltage adjustment range	GHA-10
1.7	Output ripple and ripple noise	GHA-10
1.8	Isolation	GHA-11
2	Series Operation and Parallel Operation	GHA-11
2.1	Series Operation	GHA-11
2.2	Parallel Operation	GHA-11
3	Assembling and Installation Method	GHA-11
3.1	Heat dissipation (derating)	GHA-12
3.2	Installation method	GHA-13
3.3	Mounting screw	GHA-14
3.4	Expectancy life and warranty	GHA-14
3.5	External capacitor on the output side	GHA-14
4	Ground	GHA-14
5	Option and Others	GHA-15
5.1	Outline of options	GHA-15
5.2	Medical Isolation Grade	GHA-17
5.3	Others	GHA-17

1 Function

1.1 Input voltage range

- The range is from AC85V to AC264V or DC130V to DC370V (please see SPECIFICATIONS for details).
- In cases that conform with safety standard, input voltage range is AC100-AC240V (50/60Hz).

(a) Recommended Capacity : 6.3A, slow-blow

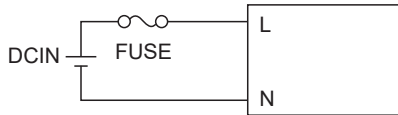

Fig.1.1 Connection method

- If input value doesn't fall within above range, a unit may not operate in accordance with specifications and/or start hunting or fail. If you need to apply a square waveform input voltage, which is commonly used in UPS and inverters, please contact us.
- When the input voltage changes suddenly, the output voltage accuracy might exceed the specification. Please contact us.

1.2 Inrush current limiting

- An inrush current limiting circuit is built-in.
- If you need to use a switch on the input side, please select one that can withstand an input inrush current.
- Thermistor is used in the inrush current limiting circuit. When you turn the power ON/OFF repeatedly within a short period of time, please have enough intervals so that a power supply cools down before being turned on.
- Surge current in the later unit does not include. (0.2ms or less).

1.3 Overcurrent protection

- An overcurrent protection circuit is built-in and activated at 105% of the rated current or 101% of the peak current. A unit automatically recovers when a fault condition is removed. Please do not use a unit in short circuit and/or under an overcurrent condition.
- Intermittent Operation Mode
Intermittent operation for overcurrent protection is included in a part of series. When the overcurrent protection circuit is activated and the output voltage drops to a certain extent, the output becomes intermittent so that the average current will also decrease.

1.4 Overvoltage protection

- An overvoltage protection circuit is built-in. If the overvoltage protection circuit is activated, shut down the input voltage, wait more than 3 minutes and turn on the AC input again to recover the output voltage. Recovery time varies depending on such factors as input voltage value at the time of the operation.

Remarks :

Please avoid applying a voltage exceeding the rated voltage to an output terminal. Doing so may cause a power supply to malfunction or fail. If you cannot avoid doing so, for example, if you need to operate a motor, etc., please install an external diode on the output terminal to protect the unit.

1.5 Thermal protection

- Over Temperature Protection (OTP) is built in.
- If this function is in operation, turn off power, eliminate all possible causes of overheating, and drop the temperature to normal level. Output voltage recovers after applying input voltage. The recovery time varies depending on input voltage and load condition.
 - ① Over rated temperature
 - ② Poor ventilation
 - ③ Over peak load based on Instruction Manual 4. for Peak loading

Remarks :

Please comply with recommended mounting method in section 3.1.

1.6 Output voltage adjustment range

- To increase an output voltage, turn a built-in potentiometer clockwise. To decrease the output voltage, turn it counterclockwise

1.7 Output ripple and ripple noise

- Output ripple noise may be influenced by measurement environment, measuring method Fig.1.2 is recommended.

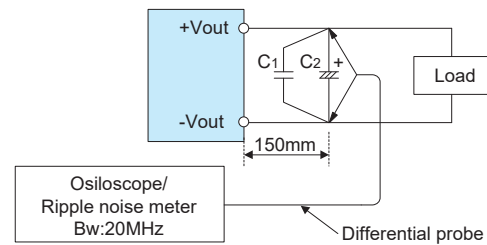

C1 : Film capacitor 0.1 μ F
C2 : Aluminum electrolytic capacitor 22 μ F

Fig.1.2 Measuring method of Ripple and Ripple Noise

Remarks :

When GND cable of probe with flux of magnetic force from power supply are crossing, ripple and ripple noise might not measure correctly.

Please note the measuring environment.

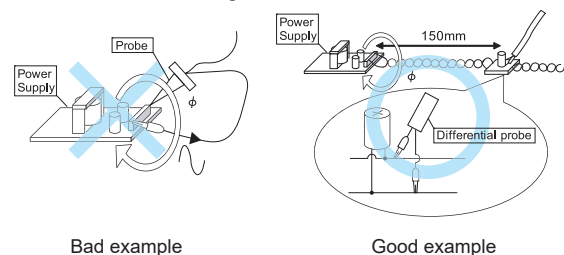

Fig.1.3 Example of measuring output ripple and ripple noise

1.8 Isolation

- For a receiving inspection, such as Hi-Pot test, gradually increase (decrease) the voltage for the start (shut down). Avoid using Hi-Pot tester with the timer because it may generate voltage a few times higher than the applied voltage, at ON/OFF of a timer.
- When you test a unit for isolation between the input and output, input and the terminal FG or between the output and the terminal FG, short-circuit between the output and the terminals RCG, PGG and AUXG.

2 Series Operation and Parallel Operation

2.1 Series Operation

- Series operation is available by connecting the outputs of two or more power supplies with the same output voltage, as shown below. Output current in series connection should be lower than the lowest rated current in each unit.

Remarks :

Please be sure to have enough cooling in case one of the power supply stops due to activation of the protection circuitry.

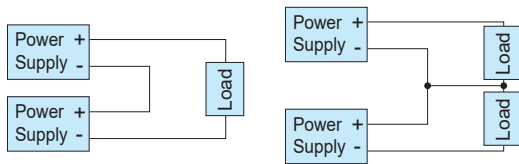

Fig.2.1 Examples of connecting in series operation

2.2 Parallel Operation

- Parallel operation
Parallel operation is possible with option "-P".
Parallel operation is not available for the standard unit, please refer to the listed options.
- Redundancy operation
Redundancy operation is available by wiring as shown below.

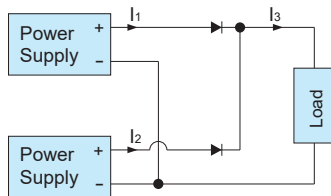

Fig.2.2 Example of redundancy operation

- Even a slight difference in output voltage can affect the balance between the values of I_1 and I_2 .
Please make sure that the value of I_3 does not exceed the rated current of a power supply.

$$I_3 \leq \text{the rated current value}$$

Please evaluate carefully and test for any possible failure modes.

- Hot-swap or Hot-plug is not available.

3 Assembling and Installation Method

- Features of the cooling method

● GHA500F

- Cooling method

Conduction cooling, forced air and convection cooling are available.

The combination of the cooling method makes mechanical design exible.

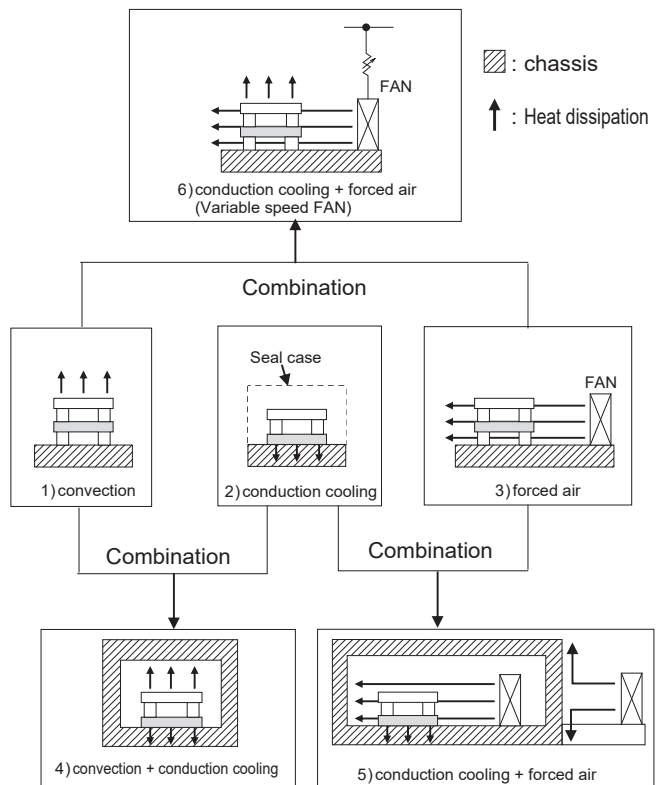

Fig.3.1 Cooling method Combination

In order to determine if the power supply operates according to our specifications, the maximum operating temperature and temperature measuring points are shown in table 3.1., for reference.

● GHA300F

■ Cooling method

Both Forced air and convection cooling are available.
(Fig 3.1 1),3),6)cooling method).

Remarks:

■ For proper operation of the power supply, please note the following:

① Heat dissipation (derating):Section 3.1 reference

- The temperature rise and heat dissipation of the converter must be considered.
- Conditions varies with environment and input voltage.
- Mounting surface will be very hot during the operation ,so please be careful not to touch the surface.

② Insulation distance: Please refer to Section 3.2

- AC voltage exist on the primary side therefore.
- In order to prevent electric shock, or to meet the leakage current requirements of the safety standard, you need to ensure the proper insulation distance.

3.1 Heat dissipation (derating)

■ Given the potential for variation between one application and another, the real test is to measure the critical components temperature rise when the power supply installed in the end-application.

For reliable and safe operation, please make sure the maximum component temperatures rise given in table 3.1 is not exceeded. Please refer to Fig.3.4 - 3.9 for derating information based on different cooling methods.

Operating at the maximum temperature rating results in 3-Years life expectancy. The actual life expectancy can be extended by reducing the ambient temperature. Please refer to section 3.4 for more information.

■ Test Measuring points

Be aware of the conductive parts during the measurements.
Please contact us for more detail.

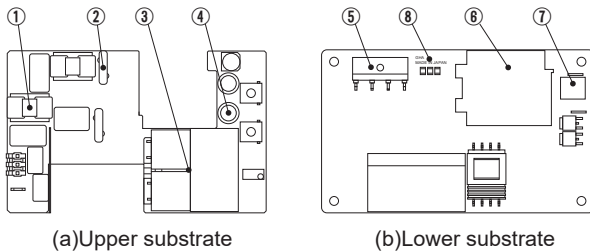

Fig.3.2 Temperature measurement points locations

Table 3.1 Maximum operating temperature

Point	Parts name	Symbol No.	Maximum temperature [°C]		Remarks
			500F	300F	
①	Line Filter	L101	115	115	
②	Varistor	SK101	76	76	
③	Input Capacitor	C106	89	89	
④	Output Capacitor	C506	87	87	
⑤	Rectifier	SS11	120	120	case temperature
⑥	Transformer	T11	110	110	
⑦	Output Choke	L51	115	115	
⑧	Aluminum base plate	-	*	-	

* Operating ambient temperature derating of Conduction cooling (Reference value)

Remarks:

There is a possibility that it is not possible to cool enough when the power supply is used by the sealing up space as showing in Fig.3.3.

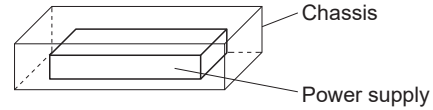

Fig.3.3 Installation example

● GHA500F

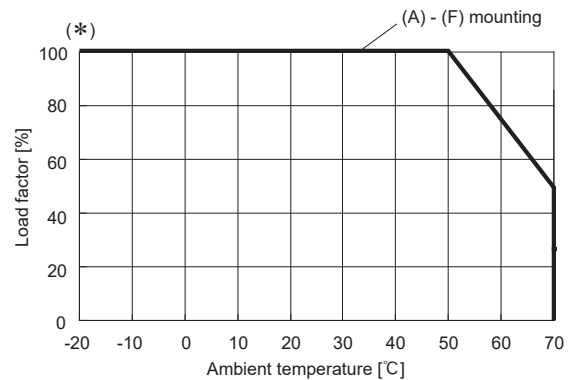

Fig.3.4 Forced air cooling derating curve (Reference value)

* Maximum power with Forced air (Fig.3.5)

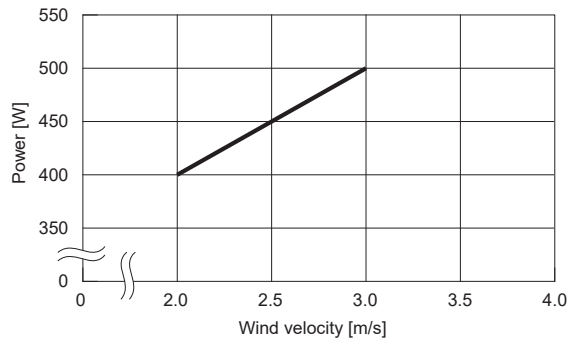

Fig.3.5 The maximum output power by wind speed conditions

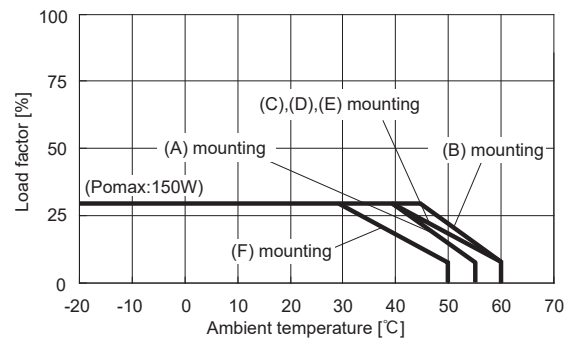

Fig.3.6 Convection cooling derating curve (Reference value)

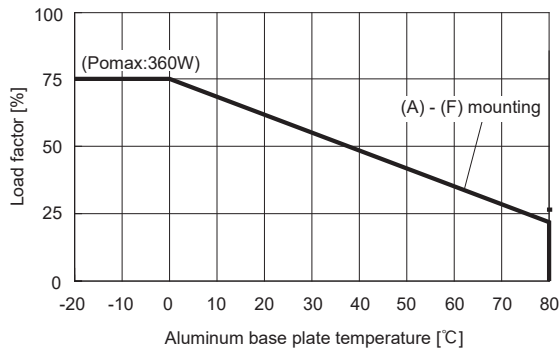

Fig.3.7 Conduction cooling derating curve (Reference value)

● GHA300F

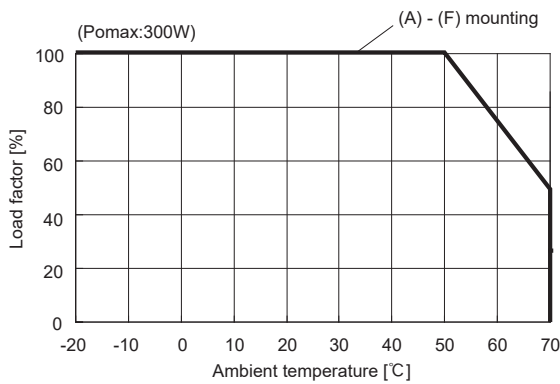

Fig.3.8 Forced air cooling derating curve (Reference value)

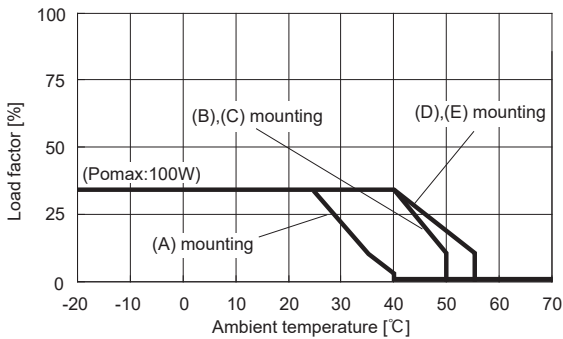

Fig.3.9 Convection cooling derating curve (Reference value)

■ Input voltage derating curve

Derating curve depending on input voltage is Fig.3.10.
For maximum power in each cooling method, please apply.

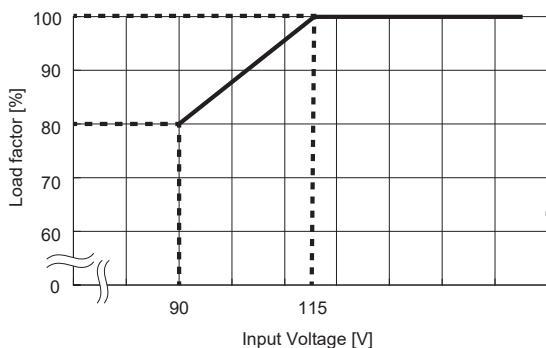

Fig.3.10 Input voltage derating curve

■ Mounting method

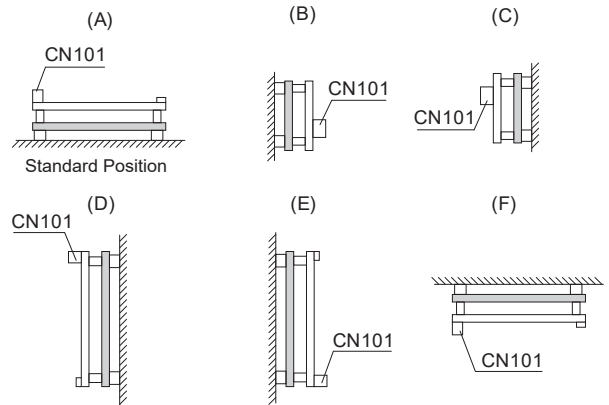

Fig.3.11 Mounting method

3.2 Installation method

■ During use, keep the distance between d_1 & d_2 for to insulate between lead of component and metal chassis, use the spacer of 5mm or more between d_1 . If it is less than d_1 & d_2 , insert the insulation sheet between power supply and metal chassis.

● GHA500F

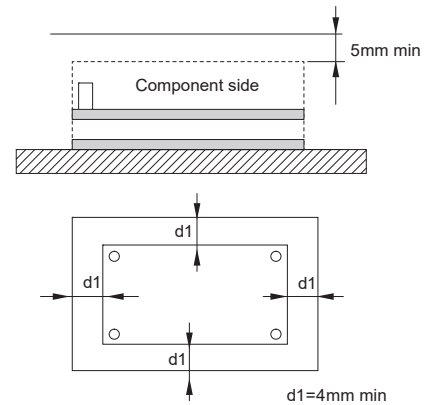

Fig.3.12 Installation method

● GHA300F

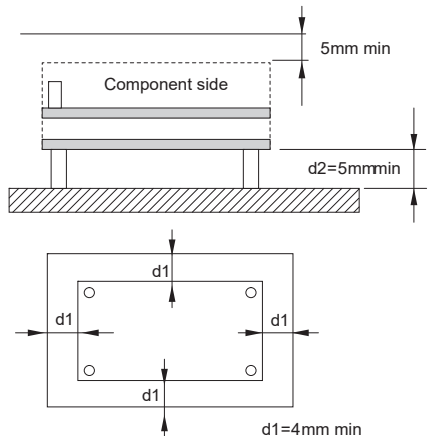

Fig.3.13 Installation method

3.3 Mounting screw

■The mounting screw should be M3. The hatched area shows the allowance of metal parts for mounting.

● GHA300F, GHA500F

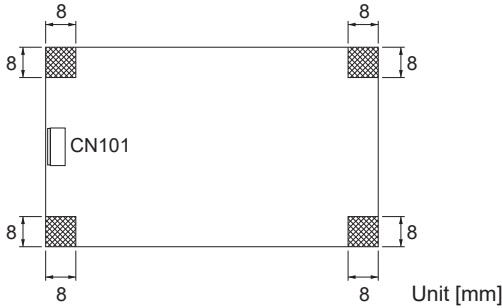

Fig.3.14 Allowance of metal for mounting

■If metallic fittings are used on the component side of the board, ensure there is no contact with surface mounted components.

■This product uses SMD technology.

Please avoid the PCB installation method which includes the twisting stress or the bending stress.

3.4 Expectancy life and warranty

■Expectancy Life.

Table 3.2 Life Expectancy (GHA500F-□)

Cooling Method	Mounting Method	Average ambient temperature (year)	Expectancy Life	
			$Io \leq 75\%$	$75\% < Io \leq 100\%$
Convection	A, C, D	Ta = 35°C or less	10years	6years
		Ta = 40°C	7years	4years
	B	Ta = 45°C	10years	7years
	E	Ta = 30°C or less	10years	7years
		Ta = 35°C	7years	5years
F	Ta = 30°C	10years	7years	
Forced air	A,B,C,D,E,F	Ta = 40°C or less	Over 10years	Over 10years
		Ta = 50°C	Over 10years	Over 10years

Table 3.3 Life Expectancy (GHA300F-□)

Cooling Method	Mounting Method	Average ambient temperature (year)	Expectancy Life	
			$Io \leq 75\%$	$75\% < Io \leq 100\%$
Convection	A	Ta = 30°C	Over 10years	Over 10years
	B, C	Ta = 45°C	Over 10years	7years
	D	Ta = 45°C	Over 10years	Over 10years
		Ta = 40°C or less	Over 10years	7years
E	Ta = 45°C	Over 10years	6years	
	Ta = 40°C or less	Over 10years	Over 10years	
Forced air	A,B,C,D,E,F	Ta = 40°C or less	Over 10years	Over 10years
		Ta = 50°C	Over 10years	Over 10years

Remarks:

Estimated life expectancy can be calculated by point temperature

③, ④ shown in section 3.1. Please contact us for details.

■Warranty

Table 3.4 Warranty (GHA500F-□)

Cooling Method	Mounting Method	Average ambient temperature (year)	Warranty	
			$Io \leq 75\%$	$75\% < Io \leq 100\%$
Convection	A, C, D	Ta = 35°C or less	5years	5years
		Ta = 40°C	5years	3years
	B	Ta = 45°C	5years	5years
	E	Ta = 30°C or less	5years	5years
Ta = 35°C		5years	4years	
F	A,B,C,D,E,F	Ta = 30°C	5years	5years
		Ta = 40°C or less	5years	4years
Forced air	A,B,C,D,E,F	Ta = 50°C	5years	3years

Table 3.5 Warranty (GHA300F-□)

Cooling Method	Mounting Method	Average ambient temperature (year)	Warranty	
			$Io \leq 75\%$	$75\% < Io \leq 100\%$
Convection	A	Ta = 30°C	5years	5years
	B, C	Ta = 45°C	5years	5years
		Ta = 45°C	5years	5years
	D	Ta = 40°C or less	5years	5years
		Ta = 45°C	5years	4years
E	A,B,C,D,E,F	Ta = 40°C or less	5years	4years
		Ta = 50°C	5years	3years

*Warranty with conduction cooling is three years at the highest point of the temperature measurement.

3.5 External capacitor on the output side

■When the load current changes rapidly, for output stability improvement, we recommend that you connect the capacitor to the output terminal.

Table 3.6 External capacity on the output recommended capacity [μF]

	Output Voltage [V]	Recommended capacity [μF]
GHA300F-12 GHA500F-12	$10.8 \leq Vo \leq 13.2$	2,200 to 22,000
GHA500F-15	$13.5 \leq Vo \leq 16.5$	2,200 to 10,000
GHA300F-24 GHA500F-24	$21.6 \leq Vo \leq 26.4$	3,300 to 8,800
GHA500F-30	$27.0 \leq Vo \leq 31.5$	3,300 to 8,800
GHA300F-48 GHA500F-48	$43.2 \leq Vo < 51.0$	0 to 1,000
	$51.0 \leq Vo \leq 52.8$	0 to 120
GHA500F-56	$52.0 \leq Vo \leq 56.0$	0 to 120

Remarks:

When load current changes rapidly, some specifications may not meet the spec.

Please mount power supply after enough evaluation and comply with recommended amount of capacitor. If you exceed the rated amount of capacitor, output for power supply may be stopped or power supply may be unstable.

4 Ground

■In the case of the power installation, please be sure to connect two or more Input FG and mounting hole FG with safety ground of the chassis.

5 Option and Others

5.1 Outline of option

● -J1

■ Connector(s) is / are replaced to VH connectors (Mfr. J.S.T.).

● -R3, -SNF

■ The following features are included.

■ Dedicated harness. Please refer to the optional parts.

■ AUX1 (12V±10% -R3 : 1.0A, -SNF : 0.5A)

- This power supply is equipped with an auxiliary low power 12V output AUX1 which is available from CN501.
- AUX has been isolated from other circuit (input, output, FG, RC, PG).
- Do not exceed the current rating, it may causes malfunction or failure of the internal circuitry.

■ AUX2 (5V1A)

- Output AUX2 will be generated from CN501. AUX2 (5V±5% 1.0A) can be used to power up remote control or other circuits. AUX has been isolated from other circuit (input, output, FG, RC, PG).
- Do not exceed the current rating, it may causes malfunction or failure of the internal circuitry.
- When the load current changes rapidly, for output stability improvement, we recommend that you connect the capacitor to the output terminal.

Table 5.1 External capacitor on the recommended capacity of AUX2

Output Voltage	recommended capacity [μF]
5V (AUX2)	GHA300/500F 330 ~ 560

■ Alarm

- Table 5.2, see Fig 5.1 the internal structure circuit explaining the operation of the PG alarm.

Table 5.2 Description of the alarm

Alarm output condition	Alarm output
PG Or lowering of the rated output voltage, output PG, PGG from terminal when you stop. *Output is unstable state when the overcurrent condition	Open collector method
	Good : Low(0-0.5V 10mA max) Bad : High or Open(40V 0.5mA max)
	Tr : 40V 10mA max

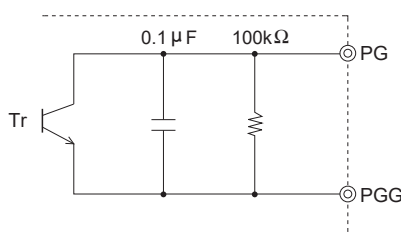

Fig.5.1 Internal circuit of PG

■ Remote ON/OFF

- You can operate the remote ON/OFF function by sending signals to CN501. Please see Table 5.3 for specifications and Fig.5.2 for connecting examples.
- Remote ON/OFF circuits (RC1 and RCG) are isolated from input, output FG, AUX and PG.
- Please note the followings when using the remote ON/OFF function.
 - ① -R3 turns on by drawing current to RC, -SNF turns off by drawing current to RC.
 - ② The current drawn to RC is a 5mA typ (maximum 30mA).
 - ③ If the output voltage is turned off through the remote ON/OFF circuit, 12V AUX stops.
 - ④ If the output voltage is turned off through the remote ON/OFF circuit, PG signals turn to "High".
 - ⑤ If voltage or current of a value not listed in Table 5.3 is applied between RC1 and RCG, the output voltage may not be generated normally.
 - ⑥ Please wire carefully. If you wire wrongly, the internal components of a unit may be damaged.

Table 5.3 Specifications of remote ON/OFF

Fig.5.2 RC circuit example		-R3	-SNF
SW Logic	Output on	SW close (3mA min)	SW open (0.1mA max)
	Output off	SW open (0.1mA max)	SW close (3mA min)
Optional harness		H-SN-34 or H-SN-35	

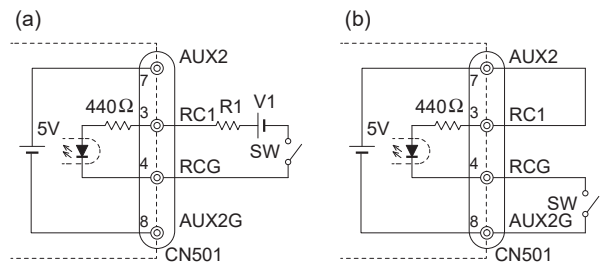

(Example V1 : 5V R1 : 270Ω)

Fig.5.2 RC circuit example

* If the output of an external power supply is within the range of 4.5 - 12.5V, you do not need a current limiting resistor R1. If the output exceeds 12.5V, however, please connect the current limiting resistor R1.

To calculate a current limiting resistance value, please use the following equation.

$$R1[\Omega] = \frac{V1 - (1.1 + Ri \times 0.005)}{0.005} \quad Ri = 440[\Omega]$$

● -SNF

- Chassis and a cooling fan are added.
- Oil and chemical environment may cause of power supply's malfunction or failure. Please avoid operation and storage in such environments.
- Derating
It should be satisfied that derating curve depending on input voltage in Fig.3.10 and derating curve on ambient temperature in Fig.5.4. As the verification method, temperature of measurement point A should be rated temperature or less in Table 5.4.

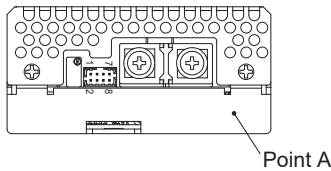

Fig.5.3 Measurement point A

Table 5.4 Rated temperature of measurement point A

Measurement	Ambient temperature	
	50°C	70°C
Point A	65°C or less	78°C or less

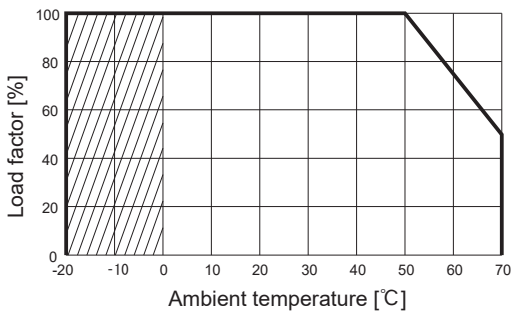

Fig.5.4 Ambient temperature derating curve (Reference)

- When output current more than rated, output may shut down after 5 seconds or more. Recycle the input after 3 minutes to reset the protection.
- Maintenance of FAN
FAN life time expectancy (R(t)=90%) in Fig.5.5 is depended on measurement point temperature in Fig.5.6, which exhaust air temperature from FAN at input terminal side.
If load wires are generating heat, intake air temperature may become high. It may influence to FAN exhaust temperature. It is a notice that optical wires have to be selected for the avoidance.
When FAN stop or air volume decrease happen, power supply's output will be shut down.

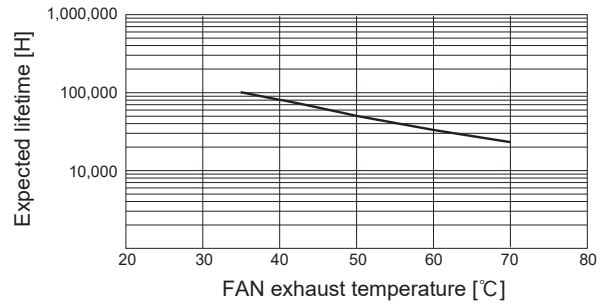

Fig.5.5 Expected life time of FAN

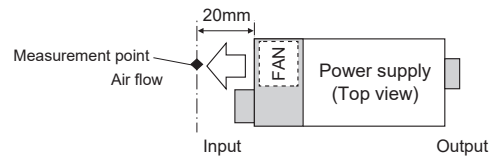

Fig.5.6 Measurement of FAN exhaust temperature

■ Mounting screw

Screw length into power supply should be shorter than 6mm due to keep safety isolation clearance from inside components in Fig.5.7. Please fix power supply surely by screws in consideration of the weight.

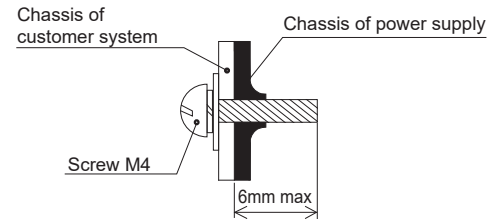
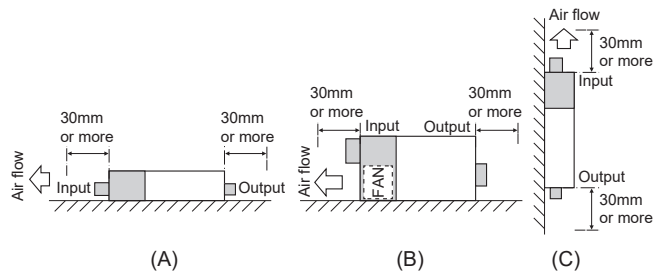

Fig.5.7 Mounting screw

- A cooling FAN is built-in. Please keep 30mm or more clearance both input and output side to make enough air ventilation. Do not block off cooling FAN's air flow for stable operation.



- When power supply is used where dust exist, it may cause of FAN failure. It is recommended to install a air filter to the system air ventilation duct.

● -T3

■ M3 threaded mounting hole is available as an option (-T3).

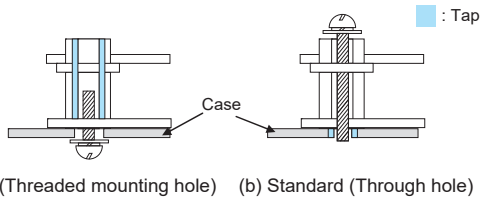

Fig.5.8 Screw mounting image

● -P

■ Parallel operation is available (Recommended two).

■ Output wattage setting is 90% per power supply of MAX OUTPUT WATTAGE.

Remarks:

- The difference of output voltage between power supply for parallel operation should be less 0.1V.
- During parallel operation, higher voltage power supply become the master in system. Depend on voltage difference between master and slave, the master power supply may recover the system's required wattage up to 90% of MAX OUTPUT WATTAGE.
- The master unit should be evaluated for heat dissipation, life expectancy and warranty period according to section 3.1 - 3.4.
- Parallel operation, due to the fluctuation of load, the output voltage may be varied.
- There is a possibility that beat noise occurs due to the difference of the oscillation frequency. Please use after enough evaluation.
- Forced air cooling is required.
- Input voltage ought be AC115V or more.

5.2 Medical Isolation Grade

■ GHA series t 2MOPP

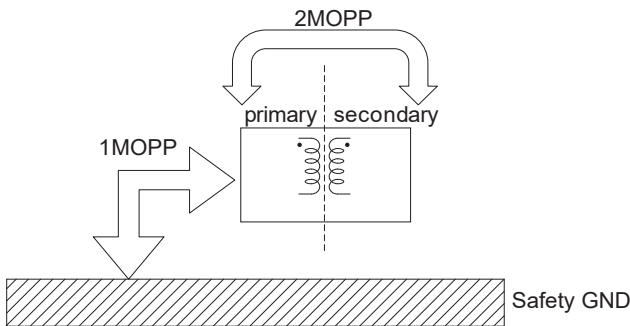

Fig.5.9 Medical Isolation Grade

5.3 Others

■ High voltage exist in the power supply for a few minutes after input voltage is stopped. Please pay attention to this during the maintenance.

■ Notes for mounting

- ① All Mounting holes should be tight and secured.
- ② Power supply should be mounted parallel to the mounting surface.
- ③ Avoid applying mechanical stress or shock to the power supply.

■ When power supply is energized or immediately after power supply stops working, power supply is still very hot, so please handle it with care.