

VS-K20 Compact Camera Controller

User Manual – English

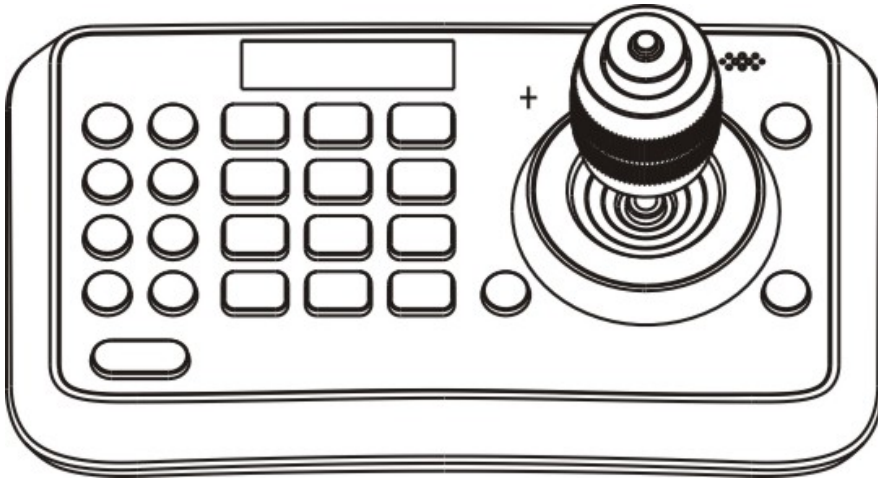

[Important]

To download the latest version of Quick Start Guide, multilingual user manual, software, or driver, etc., please visit Lumens
<http://www.MyLumens.com>

Table of Contents

Copyright Information.....	2
Chapter 1 Safety Instructions.....	3
Precautions	4
FCC Warning	4
EN55022 (CE Radiation) Warning.....	4
Chapter 2 About The Product.....	5
2.1 Introduction.....	5
2.2 Features	5
2.3 Technical Data	5
2.4 Parts and view	6
2.5 Connections.....	8
Chapter 3 Setting Menu	10
Chapter 4 Menu operation	12
4.1 Camera Setting.....	12
4.2 Time Setting.....	13
4.3 Volume Setting	13
4.4 Backlight Setting	13
4.5 Sleep Setting	14
4.6 Pin Setting	14
4.7 Joystick Calib.....	15
4.8 Speed Setting	15
4.9 Default Setting	16

Copyright Information

Copyrights © Lumens Digital Optics Inc. All rights reserved.

Lumens is a trademark that is currently being registered by Lumens Digital Optics Inc.

Copying, reproducing or transmitting this file is not allowed if a license is not provided by Lumens Digital Optics Inc. unless copying this file is for the purpose of backup after purchasing this product.

In order to keep improving the product, Lumens Digital Optics Inc. hereby reserves the right to make changes to product specifications without prior notice. The information in this file is subject to change without prior notice.

To fully explain or describe how this product should be used, this manual may refer to names of other products or companies without any intention of infringement.

Disclaimer of warranties: Lumens Digital Optics Inc. is neither responsible for any possible technological, editorial errors or omissions, nor responsible for any incidental or related damages arising from providing this file, using, or operating this product.

Chapter 1 Safety Instructions

Always follow these safety instructions when setting up and using the Camera Controller:



1. Use attachments only as recommended.
2. Use the type of power source indicated on the Camera Controller. If you are not sure of the type of power available, consult your distributor or local electricity company for advice.
3. Always take the following precautions when handling the plug. Failure to do so may result in sparks or fire.
 - Ensure the plug is free of dust before inserting it into a socket.
 - Ensure that the plug is inserted into the socket securely.
4. Do not overload wall sockets, extensions leads or multi-way plug boards as this may cause fire or electric shock.
5. Do not place the Camera Controller where the cord can be stepped on as this may result in fraying or damage to the lead or the plug.
6. Never allow liquid of any kind to spill into the Camera Controller.
7. Except as specifically instructed in this User Manual, do not attempt to operate this product by yourself. Opening or removing covers may expose you to dangerous voltages and other hazards. Refer all servicing to licensed service personnel.
8. Unplug the Camera Controller during thunderstorms or if it is not going to be used for an extended period. Do not place the Camera Controller or remote control on top of vibrating equipment or heated objects such as a car, etc.
9. Unplug the Camera Controller from the wall outlet and refer servicing to licensed service personnel when the following situations happen:
 - If the power cable or plug becomes damaged or frayed.
 - If the Camera Controller is wet with liquid, rain or water.

<Note> Using an incorrect battery type in the remote control may result in breakdown. Follow local instructions on how to dispose of used batteries.

■ Precautions

Warning: To reduce the risk of fire or electric shock, do not expose this appliance to rain or moisture.

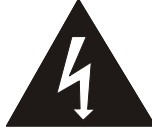
If Camera Controller will not be used for an extended time, unplug it from the power socket.

	<p>Note</p> <p>Risk of Electric Shock</p> <p>DO NOT OPEN</p>	
<p>Caution: To reduce the risk of electric shock, do not remove cover (or back). No user-serviceable parts inside. Refer servicing to licensed service personnel.</p>		
	<p>This symbol indicates that this equipment may contain dangerous voltage which could cause electric shock.</p>	
		<p>This symbol indicates that there are important operating and maintenance instructions in this User Manual with this unit.</p>

■ FCC Warning

This Camera Controller has been tested and found to comply with the limits for a Class A digital device, pursuant to Article 15-J of FCC Rules. These limits are designed to provide reasonable protection against harmful interference in a commercial installation.

This digital apparatus does not exceed the Class A limits for radio noise emissions from digital apparatus as set out in the interference-causing equipment standard entitled "Digital Apparatus," ICES-003 of Industry Canada.

Cet appareil numérique respecte les limites de bruits radioélectriques applicables aux appareils numériques de Classe A prescrites dans la norme sur le matériel brouilleur: "Appareils Numériques," NMB-003 édictée par l'Industrie.

■ EN55022 (CE Radiation) Warning

This product is intended for use in a commercial, industrial, or educational environment. It is not intended for residential use.

This is a Class A product. In a residential environment it may cause radio interference, in which case the user may be required to take adequate measures. The typical use is in a conference room, reception room or hall.

Chapter 2 About The Product

2.1 Introduction

The mini Compact Camera Controller is a full-function system keyboard. With features of ergonomic design, multi-function, high reliability and easy operation, it is a perfect controller for rugged PTZ cameras, video conference cameras, surveillance cameras and so on

2.2 Features

- 4D joystick for pan/tilt/zoom/focus control, ergonomic design and excellent finishing;
- High brightness OLED display;
- Auto backlight keys;
- Multi-level protection from illegal operation or setting;
- Multi-baud rate and protocols;
- 7address;
- Batch program cameras in the systems;
- Compact design with portable features;

2.3 Technical Data

Comm. Interface	RS-232 /RS422
Protocol	VISCA/PELCO-D
Baud Rate	9600bps · 38400bps
Address	1~255
Joystick	4-axis (Left/Right, Up /Down, Zoom In/Zoom Out, Focus Near / Focus Far)
Display	OLED
Power	DC12V
Power Consumption	<2W
Working Temperature	0°C ~+40°C
Storage Temperature	-20°C ~+60°C
Relative Humidity	≤90% (non-condensation)
Dimensions	200mm(L)*120mm(W)*103mm(H)
Net Weight	0.5kg

2.4 Parts and view

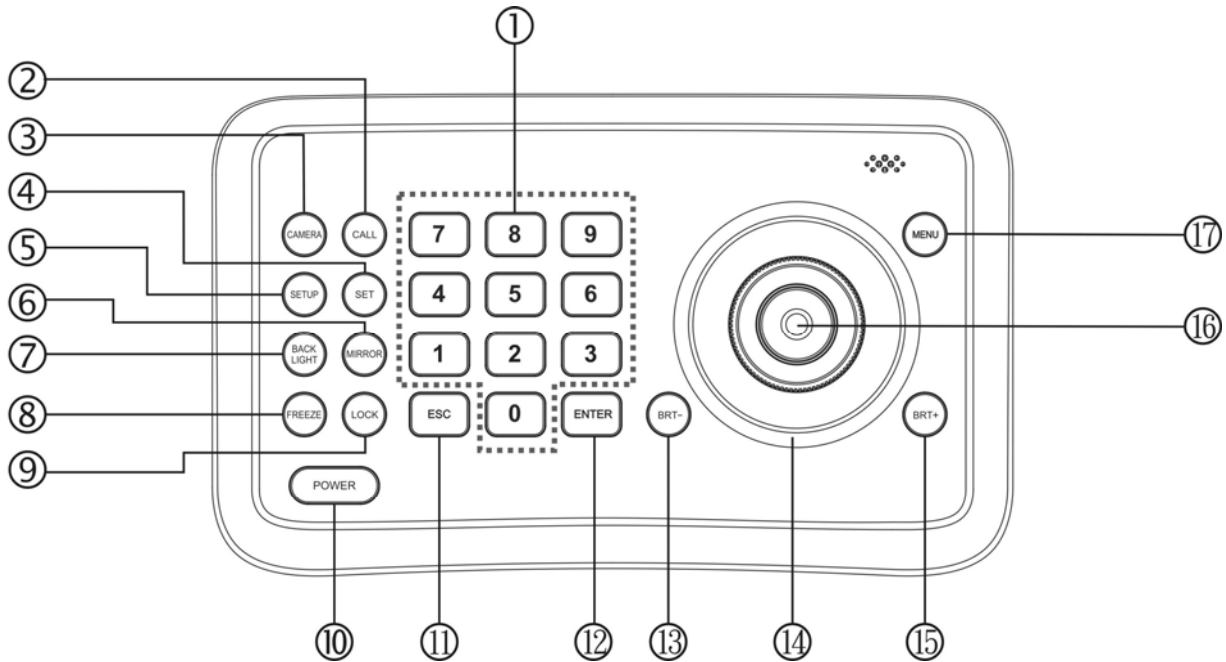

① 0~9 (Numbers)

Those are keys used to input numbers.

② CALL (Call preset)

Input preset number, then press **CALL** key to call a preset

③ CAMERA (Switch cameras)

Input camera number, then press **CAMERA** key to switch to another camera.

④ SET (Set / Clear preset)

Input preset number, then press **SET** key to set or delete a preset (Short press to “set”; long press to “clear”).

⑤ SETUP (Enter setup menu)

Press **SETUP** key to enter menu and program the keyboard

⑥ MIRROR (flip the image)

Press **MIRROR** key to control the image flip of the camera.
(Normal/ Mirror/ Flip/ Mirror+Flip)

⑦ BACK LIGHT (Turn on/off Camera back light compensation)

Press **BACK LIGHT** key to turn on / off the back light compensation.

⑧ FREEZE (Freeze the screen)

Press **FREEZE** key to control the image freeze of the camera.

⑨ LOCK (keyboard lock)

Press **LOCK** key to lock the control keyboard and key in the user password to unlock the keyboard.

⑩ POWER (Power switch)

Press **POWER** key to turn on / off the camera.

⑪ ESC (Exit / Delete)

It is a key to EXIT in a menu or DELETE in other operations.

⑫ ENT (Confirm)

It is used to confirm menu setting.

⑬ BRT-(turn down the brightness)

Press **BRT-** key to turn down the image brightness.

⑭ Joystick

This joystick is used to Pan, Tilt, Zoom and Focus

Non-Menu State:

Left/Right/Up/Down: Pan/Tilt the camera correspondingly

Twist clockwise: Zoom In,

Twist anti-clockwise: Zoom Out;

Press Zoom/ Focus Switch Key and Twist: Focus Near/Far

Menu State:

Right: Enter a submenu or Confirm;

Left: Return to previous menu or exit (expect some not returnable menus);

Up: Move to last option;

Down: Move to next option.

⑮ BRT+ (turn up the brightness)

Press **BRT+** key to turn up the image brightness.

⑯ Zoom / Focus Switch Key

This key is used to switch between zoom and focus function.

Operation: Press this key, the crisscross of indicator lighter near the joystick will go out, twist the joystick to zoom in / out; press this key again, the crisscross of indicator lighter will be lightened, twist the joystick will adjust focus value.

⑰ MENU (Enter Camera Menu)

This key is used to enter camera menu.

2.5 Connections

2.5.1 Connections

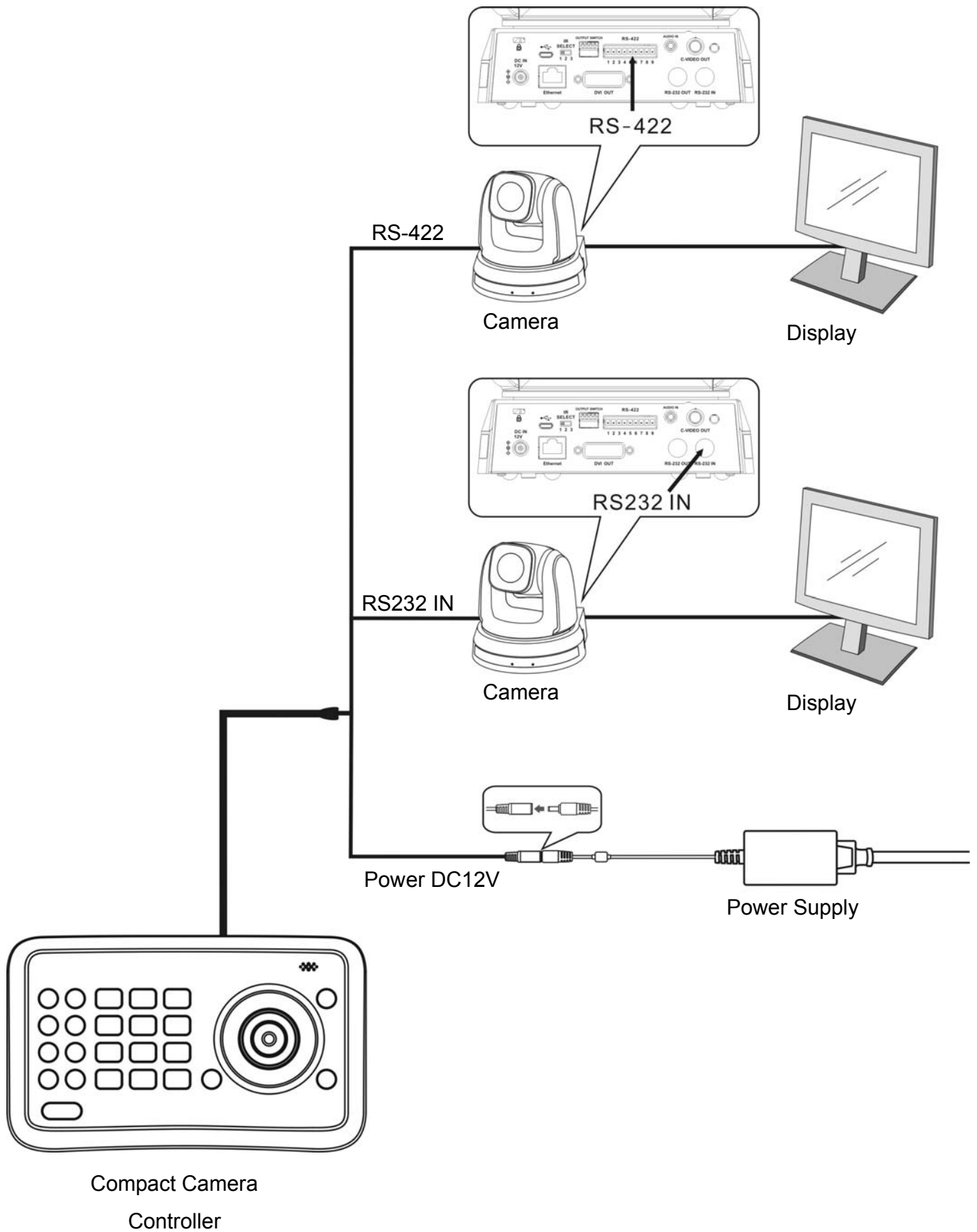

2.5.2 RS-422 Pins instructions

Pin No.	function
1	GND
2	RXD IN-
3	RXD IN+
4	TXD IN-
5	TXD IN+

2.5.3 RS232 Pins instructions

Pin No.	function
1	NA
2	NA
3	TXD
4	GND
5	RXD
6	NA
7	NA
8	NA

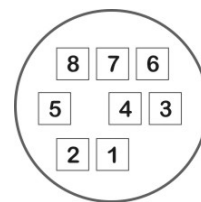

Chapter 3 Setting Menu

<Remark> Press [SETUP] on the **remote control** to enter the setting menu; the **bold underlined** values in the following table are defaults.

1 st Level Major Items	2 nd Level Minor Items	3 rd Level Adjustment Values	Function Descriptions
Camera Setting	Camera ID	1~ <u>C</u> ~255	Set camera ID VISCA only works with ID 1~7
	Protocol	<u>V</u>	V : VISCA , ID 1~7
		PD	PD : PELCO D , ID 8~255
	Baud Rate	1. <u>9600</u> 2. 38400	Set baud rate. This baud rate must be the same as the camera's baud rate.
	Address	1~ <u>C</u> ~7	Camera's address, this address must be the same as the camera's ID.
Time Setting	Set Time	xx:xx:xx	Set time in 24 hour format
Time Display		1. <u>On</u> 2. Off	Set the time display
Volume Setting	-	1. <u>Off</u> 2. 1~6	Adjust the volume of the controller
Keyboard Light	-	3. <u>Auto</u> 4. On 5. Off	Set the backlight of the controller on or off
Sleep Setting	-	1. <u>Off</u> 2. 60m 3. 30m 4. 10m 5. 5m 6. 1m 7. 30s	Set sleep time of the controller.
Pin Setting	-	1. <u>User</u> 2. Admin	Set user and admin pins of the controller

Joystick Calib	Pan Left	-	Calibrate the joystick leftward
	Pan Right	-	Calibrate the joystick rightward
	Tilt Up	-	Calibrate the joystick upward
	Tilt Down	-	Calibrate the joystick downward
	Zoom Tele	-	Calibrate the joystick with Zoom Tele
	Zoom Wide	-	Calibrate the joystick with Zoom Wide
	Free State	-	setting menu, no need any operation.
	-	<u>Save</u>	Save the calibration setting
	-	<u>Cancel</u>	Cancel the calibration setting
Speed Setting	-	1. <u>High</u> 2. Middle 3. Low	Set control speed of the joystick.
Default Setting	-	1. Yes 2. <u>No</u>	Restore the keyboard setting to factory default.
Information	-	-	Related information for the control keyboard

Chapter 4 Menu operation

After powered on, “USER PIN” will show on the controller’s screen. The initial pin is “111111”.

- **Pin Error** : When “USER PIN : ERROR” shows on screen, it indicates wrong pin was input. Enter correct pin to get to next step
- **Pin Correct** : Screen shows “1” camera icon and default camera number. If there is no further operation for long time, screen will display current time automatically. If still no operations, the controller will enter sleeping mode.

Enter OSD menu

Press **SETUP** key.

Screen shows “ADMIN PIN:”. Initial admin pin is “111111”.

4.1 Camera Setting

Set camera ID (Range from 1~255), corresponding protocol, baud rates and camera address of the target cameras. Then every camera can be controlled easily by choosing their relative camera ID.

1. Move up / down the joystick, choose “CAMERA SETTING”.
2. Right move the joystick or press **ENT** key to enter menu “1 : ” .
Press number keys to input camera number (range from 1~255) . If the input number exceeds this range, the system will show “ERROR”. After the setting is finished, press **ENT** key to confirm ◦
3. “Protocol” Setting Menu. Move up/down the joystick, choose Protocol (V / PD) ◦
< Note > VISCA only works with Camera ID 1~7.
4. Baud rate setting. Move up/down the joystick, choose baud rate, and right move the joystick or press **ENT** to confirm.
5. Address Setting. Input number to set camera address (range from

1~7). Press **ENT** to confirm.

6. After the camera setting is finished, the system will automatically return to the main menu.

4.2 Time Setting

Set time in 24 hour format.

1. Move the joystick up/ down, choose "TIME SETTING".
2. Right move the joystick or press **ENT** to get into time setting menu, "H" hour becomes editable, input digits from keypad or move joystick up / down to set the "H" (range: 0~23).

If input digits by keypad, after the hour has been set, it will automatically get into "M" minute setting;

if set by joystick, right move the joystick to get into "M" minute setting. Move right / left the joystick to select from "H", "M" and "S" settings.

3. "M" minute setting menu. Set the "M" minute and "S" second, refer to "H" hour setting.
4. Press **ENT** to save and return to Main Menu.

4.3 Volume Setting

6 levels of volume from low to high are available to choose from.

1. Move the joystick up/down, select " VOLUME SETTING".
2. Right move the joystick or press **ENT** to get into " VOLUME SETTING" ; after setting right move the joystick or press **ENT** to confirm.

4.4 Backlight Setting

Back light mode enables the keys to be clearly presented even at very dark environment.

1. Move the joystick up/ down, select " BACKLIGHT MODE".

2. Right move the joystick or press **ENT** to enter “BACKLIGHT MODE”.
Move the joystick up/ down to select backlight options. Right move the joystick or press **ENT** to confirm.

4.5 Sleep Setting

Set sleep time of the controller. In non-menu status, the screen will enter the sleep mode if no operation is performed for a programmable period.

1. Move the joystick up/ down, select “ SLEEP SETING”.
2. Right move the joystick or press **ENT** to enter “ SLEEP SETTING” .
Move the joystick up/ down to select sleep time. Right move the joystick or press **ENT** to confirm.

4.6 Pin Setting

Set user and admin pins of the controller.

1. Move the joystick up/ down, select “PIN SETTING”.
2. Right move the joystick or press **ENT** to enter “PIN SETTING”.
Move the joystick up/ down to select the PIN digits. Right move the joystick or press **ENT** to confirm.
3. Enter the PIN setting menu. “OLD PIN” requires to be input, press **ESC** to cancel input digit. If correct Pin is input, it will get into “NEW PIN” menu. If wrong pin is input, “ERROR” will be displayed.
4. Input “NEW PIN”
5. “CONFIRM”: after new pin is input, input it again to confirm. If the two pins don't match, it displays “PIN NOT MATCH”, menu goes back to “NEW PIN”.
6. If the two pins match, it displays “OK!” and new pin will be applicable..

To disable “PIN PROTECTION” function, there is no need to input any digit in both “NEW PIN” and “CONFIRM”, press **ENT** directly to confirm.

To enable "PIN PROTECTION" again, simply set new pins with digits
During these operations, press key **ESC** to exit the PIN setting menu.

4.7 Joystick Calib

After long-time use, the joystick may require calibration.

1. Move the joystick up/ down, select "JOYSTICK CALIB".
2. Right move the joystick or press **ENT** to confirm, enter the "JOYSTICK CALIB" menu. "PAN LEFT" will be displayed, move the joystick to the left limit and hold, then press **ENT** to finish "PAN LEFT" calibration. It will enter next menu.
3. Refer to the setting of "PAN LEFT" to calibrate "PAN RIGHT", "TILT UP" and "TILT DOWN".
4. " "ZOOM TELE" calibrating menu, twist the joystick clockwise until limit position, and press **ENT**.
5. "ZOOM WIDE" calibrating menu, twist the joystick anticlockwise until limit position, and press **ENT** .
6. "FREE STATE" setting menu, no need any operation, simply press **ENT** to confirm.
7. Upon completion of the above settings, "<SAVE> CANCEL" will be displayed to save or cancel. Move the joystick left/ right to choose, and press **ENT** to confirm.

4.8 Speed Setting

Set control speed of the joystick.

1. Turn the joystick up/down, choose "SPEED SETTING".
2. Right move the joystick or press **ENT** to enter "SPEED SETTING" menu. Move the joystick up/ down to switch among speed levels, and right move the joystick or press **ENT** to confirm.

4.9 Default Setting

Restore the keyboard setting to factory default.

1. Move the joystick up/ down, choose "DEFAULT SETTING".
2. Right the joystick or press **ENT** key, enter "DEFAULT SETTING" menu, move the joystick left/ right, select options "<YES> NO", press **ENT** to confirm.