

NanoPZ™

Ultra-High Resolution Motion System



USER'S MANUAL

Warranty

Newport Corporation warrants that these products will be free from defects in material and workmanship and will comply with Newport's published specifications at the time of sale for a period of one year from date of shipment.

If found to be defective during the warranty period, products will either be repaired or replaced at Newport's option.

To exercise this warranty, write or call your local Newport office or representative, or contact Newport headquarters in Irvine, California. You will be given prompt assistance and return instructions. Send the products, freight prepaid, to the indicated service facility. Repairs will be made and the products returned freight prepaid. Repaired products are warranted for the remainder of the original warranty period or 90 days, whichever occurs last.

Limitation of Warranty

The above warranties do not apply to products which have been repaired or modified without Newport's written approval, or products subjected to unusual physical, thermal or electrical stress, improper installation, misuse, abuse, accident or negligence in use, storage, transportation or handling. This warranty also does not apply to fuses, batteries, or damage from battery leakage.

THIS WARRANTY IS IN LIEU OF ALL OTHER WARRANTIES, EXPRESSED OR IMPLIED, INCLUDING ANY IMPLIED WARRANTY OF MERCHANTABILITY OR FITNESS FOR A PARTICULAR USE. NEWPORT CORPORATION SHALL NOT BE LIABLE FOR ANY INDIRECT, SPECIAL, OR CONSEQUENTIAL DAMAGES RESULTING FROM THE PURCHASE OR USE OF ITS PRODUCTS.

First printing 2005

© 2006 by Newport Corporation, Irvine, CA. All rights reserved. No part of this manual may be reproduced or copied without prior written approval of Newport Corporation.

This manual is provided for information only, and product specifications are subject to change without notice. Any change will be reflected in future printings.

Newport Corporation
1791 Deere Avenue
Irvine, CA, 92606, USA
Part No. 44019-01, Rev. E

Table of Contents

Warranty	ii
EU Declaration of Conformity	vi
<hr/>	
Preface	vii
Confidentiality & Proprietary Rights	vii
Service Information.....	vii
Sales, Tech Support & Service.....	viii
Newport Corporation USA Calling Procedure	viii
<hr/>	
1.0 — Safety Precautions	1
1.1 Definitions and Symbols	1
European Union CE Mark	1
C-US CSA Mark	1
Direct Current (DC)	1
1.2 Warnings and Cautions	2
General Warnings	2
General Cautions	2
1.3 Manual Conventions	3
<hr/>	
2.0 — Features & Specifications	3
2.1 NanoPZ™ System Overview	3
2.2 PZA12 Actuator	4
General Use	4
Motion Principle	4
Mechanical Compatibility	6
PZA12 Design Details	7
2.3 PZC200 Controller/Driver	7
PZC200 Specifications	9
2.4 PZC-SB Switchbox.....	10
PZC-SB Specifications	11
2.5 NSC-PS25 Power Supply.....	12
NSC-PS25 Specifications	13
2.6 NSC-JB RS-485 Junction Box.....	14
NSC-JB Specifications.....	15
2.7 NSC-485-232-I RS-485 to RS-232 Converter.....	15

	NSC-485-232-I Specifications.....	16
2.8	NanoPZ System Environmental Specifications	16
<hr/>		
3.0	—Getting Started	17
3.1	Unpacking and Handling.....	17
3.2	Inspection for Damage.....	17
3.3	Inventory of Parts.....	17
3.4	Interconnecting Components	18
<hr/>		
4.0	— Local Operation	23
4.1	Operating Modes	23
4.2	Local (Manual) Control.....	23
4.3	Reading the LED Status Lights.....	25
	LED Indicator on PZC200 Controller	25
	LED Indicators on PZC-SB Switchbox	25
<hr/>		
5.0	— Utility Software	26
5.1	Overview.....	26
5.2	RS-232 Communications Setup	26
5.3	Software Installation	27
5.4	Controller Initialization.....	28
5.5	Network Scan	29
5.6	Working with the Main Screen	30
	Move Tab	31
	Setup Tab.....	32
	View all Tab	33
	Status Tab.....	34
	About Tab.....	35
<hr/>		
6.0	— ASCII Command Set	36
6.1	Command Set Introduction	36
	Address Field	36
	Set or Query Commands	36
	Saving Settings to Non-Volatile Memory	37
	Motion Commands	37
6.2	Command Set Summary	38

6.3	Command Set Details	39
	BX Scan switchbox	39
	BZ Restore EEPROM content to default	39
	ID Actuator description	40
	JA Start jog motion	41
	MF Motor OFF	42
	MO Motor ON	42
	MX Select switchbox channel	42
	OR Zero position	43
	PH Get hardware status	44
	PR Position relative	45
	RS Reset controller	46
	SA Set controller address	46
	SL Set negative (left) travel limit.....	46
	SM Save settings to non-volatile memory.....	47
	SR Set positive (right) travel limit.....	48
	ST Stop motion	49
	TE Read error code	49
	TP Read current position	50
	TS Controller status.....	51
	VE Read controller firmware.....	51
<hr/>		
7.0	— Maintenance & Service	52
	7.1 Enclosure Cleaning.....	52
	7.2 Technical Support	52
<hr/>		
	Service Form.....	53

EU Declaration of Conformity

We declare that the accompanying product, identified with the “CE” mark, complies with requirements of the Electromagnetic Compatibility Directive, 89/336/EEC and the Low Voltage Directive 73/23/EEC.

Product Name: NanoPZ™

Model Number: PZA12 NanoPZ actuator, PZC200 NanoPZ controller, PZC-SB switchbox

Year CE mark affixed: 2005

Type of Equipment: Electrical equipment for measurement, control and laboratory use.

Standards Applied:

Compliance was demonstrated to the following standards to the extent applicable:

BS EN61326-1: 1997+A1+A2+A3 “Electrical equipment for measurement, control and laboratory use – EMC requirements”.

This equipment meets the CISPR 11 Class A Group 1 radiated and conducted emission limits:

- BS EN 61000-3-2:2001, Harmonic current emissions, Class A.
- BS EN 61000-3-3:2002, Voltage fluctuations and flicker.
- BS EN 61010-1:2001, 2nd Edition “Safety requirements for electrical equipment for measurement, control and laboratory use”.

Alain Danielo



VP European Operations
Systems
Zone Industrielle
45340 Beaune-la-Rolande, France

Dan Dunahay



Director of Quality
1791 Deere Avenue
Irvine, Ca. USA

Preface

Confidentiality & Proprietary Rights

Reservation of Title

The Newport programs and all materials furnished or produced connected there-with (“Related Materials”) contain trade secrets of Newport and are for use only in the manner expressly permitted. Newport claims and reserves all rights and benefits afforded under law in the Programs provided by Newport Corporation.

Newport shall retain full ownership of Intellectual Property Rights in and to all development, process, align or assembly technologies developed and other derivative work that may be developed by Newport. Customer shall not challenge, or cause any third party to challenge, the rights of Newport.

Preservation of Secrecy and Confidentiality and Restrictions to Access

Customer shall protect the Newport Programs and Related Materials as trade secrets of Newport, and shall devote its best efforts to ensure that all its personnel protect the Newport Programs as trade secrets of Newport Corporation. Customer shall not at any time disclose Newport’s trade secrets to any other person, firm, organization, or employee that does not need (consistent with Customer’s right of use hereunder) to obtain access to the Newport Programs and Related Materials. These restrictions shall not apply to information (1) generally known to the public or obtainable from public sources; (2) readily apparent from the keyboard operations, visual display, or output reports of the Programs; 3) previously in the possession of Customer or subsequently developed or acquired without reliance on the Newport Programs; or (4) approved by Newport for release without restriction.

Service Information

This section contains information regarding factory service for the source. The user should not attempt any maintenance or service of the system or optional equipment beyond the procedures outlined in this manual. Any problem that cannot be resolved should be referred to Newport Corporation.

Sales, Tech Support & Service

North America & Asia

Newport Corporation
1791 Deere Ave.
Irvine, CA 92606, USA

Sales

(949) 253-1461 or (800) 222-6440 x31461
e-mail: sales@newport.com

Technical Support

(949) 253-1406 or (800) 222-6440 x31406
e-mail: tech@newport.com

Service, RMAs & Returns

(949) 253-1694 or (800) 222-6440 x31694
e-mail: istd.service@newport.com

Europe

MICRO-CONTROLE Spectra-Physics S.A
1, rue Jules Guesde – Bât. B
ZI Bois de l'Épine – BP189
91006 Evry Cedex
France

Sales & Technical Support

+33 (0)1.60.91.68.68
e-mail: france@newport-fr.com

Service & Returns

+33 (0)2.38.40.51.55

Newport Corporation USA Calling Procedure

If there are any defects in material or workmanship or a failure to meet specifications, promptly notify Newport's Returns Department by calling **1-800-222-6440** (US customers only) or by visiting our website at www.newport.com/returns within the warranty period to obtain a Return Material Authorization Number (RMA#). Return the product to Newport Corporation, freight prepaid, clearly marked with the RMA#, and we will either repair or replace it at our discretion. Newport is not responsible for damage occurring in transit and is not obligated to accept products returned without an RMA#. Email: rma.service@newport.com

When calling Newport Corporation, please provide the Customer Care Representative with the following information:

- Your Contact Information
- Serial number or original order number
- Description of problem (i.e., hardware or software)

To help our Technical Support Representatives diagnose your problem, please note the following conditions:

- Is the system used for manufacturing or research and development?
- What was the state of the system right before the problem?
- Have you seen this problem before? If so, how often?
- Can the system continue to operate with this problem? Or is the system non-operational?
- Can you identify anything that was different before this problem occurred?

NanoPZ™

Ultra-High Resolution Motion System

1.0 Safety Precautions

1.1 Definitions and Symbols

European Union CE Mark



Figure 1: CE Mark.

The CE mark indicates that the equipment has been designed and tested to comply with all applicable European Union (CE) regulations.

C-US CSA Mark



Figure 2: CSA Mark.

The presence of the C-US CSA mark indicates that the equipment has been designed, tested and certified as complying with all applicable US and Canadian safety standards.

Direct Current (DC)



Figure 3: Direct Current Symbol.

This symbol indicates that the equipment is suitable for DC power only.

1.2 Warnings and Cautions

The following are definitions of Warnings, Cautions and Notes that may be used in this manual to call your attention to important information regarding your safety, to the safety and preservation of your equipment, and to important tips.



WARNING

Situation has potential to cause bodily harm or death.



CAUTION

Situation has potential to cause damage to property or equipment.

NOTE

Additional information the user or operator should consider.

General Warnings

Observe these general warnings when operating or servicing this equipment.

- Read all warnings on the unit and in the operating instructions.
- Do not use this equipment in or near water.
- Only connect the power cord to a grounded power outlet.
- Route power cords and other cables so they are not likely to be damaged.
- Disconnect power before cleaning the equipment. Do not use liquid or aerosol cleaners; use only a damp lint-free cloth.
- To avoid explosion, do not operate this equipment in an explosive atmosphere.

General Cautions

Observe these cautions when operating or servicing this equipment:

- Use only specified replacement parts.
- Follow precautions for static sensitive devices when handling this equipment.
- This product should only be powered as described in this manual.
- There are no user-serviceable parts inside the NanoPZ system components.
- If this equipment is used in a manner not specified within this manual, the protection provided by the equipment may be impaired.
- Do not position this equipment in a location that would make it difficult to disconnect the AC power cord.

1.3 Manual Conventions

The following conventions are used in this manual:

- **Acronyms** appear on the first occurrence enclosed in parentheses following their definition. An acronym is a word formed from the initial letters of a string of words. Example: Read Only Memory (ROM).
- **Italics or boldface text** are used as an alternative to quotation marks to highlight special text, such as keyboard keys, onscreen buttons, or text entries. Examples: Press *Enter*. **AU** command.

2.0 Features & Specifications

2.1 NanoPZ™ System Overview

Newport's NanoPZ family of piezo motor actuators and controllers is designed to provide cost-effective, nanometer-scale remote positioning of manual stages and optical mounts in a wide range of opto-mechanical systems. NanoPZ system components (as of June 2005) may include one or more of the following:

Model	Description
PZA12	NanoPZ actuator, 12.5 mm travel.
PZC200	Hand-held controller for PZA12.
NSC-PS25	AC power supply for PZC200.
NSC-PSC1	1 meter power supply output cable.
NSC-PSC3	3 meters power supply output cable.
NSC-485-232-I	RS-485 to RS-232 converter.
USB-232	RS-232 to USB converter. Requires Windows™ operating system.
NSC-JB	Junction box to split 1 RS-485 channel into to 5 channels.
NSC-CB1	0.3 meter RS-485 cable.
NSC-CB3	2.7 meter RS-485 cable.
PZC200-KT	Kit including 1 x PZA12 actuator, 1 x PZC200 controller, 1 x NSC-PC25 power supply, and 1 x NSC-PSC3 power supply cable.
PZC-SB	Switchbox allowing one PZC200 to drive up to 8 PZA12 actuators. Included cables: 41791-01: 1.8 m (6 ft) power cable to controller.

15769-02: 1.8 m (6 ft) driver cable to controller.

NSC-CB2: 1.8 m (6 ft) RS-485 cable to controller.

2.2 PZA12 Actuator



Figure 4: PZA12 Actuator.



Figure 5: Mounted PZA12.

General Use

The PZA12 is a piezo motor driven actuator allowing nanometer-scale remote adjustment of manual-positioning stages and opto-mechanical components over large distances, in hard to reach spaces and in hazardous hands-off applications.

Typical applications include fiber alignment, micro assembly, cell manipulation, probing, alignments of laser cavities, phase-matching, and laser beam stabilization.

PZA12 actuators incorporate an innovative piezo stepping motor that ensures highly reliable motion with 30 nm sensitivity over 12.5 mm travel and no loss of position when power is removed.

To avoid contact surface wear, PZA12 actuators feature a non-rotating tip. And a cover prevents damage to the drive train and protects from dust, debris and other pollutants.

PZA12 actuators are compatible with an array of Newport products. For details please refer to the latest Newport catalog or the Newport web page (www.newport.com).

The PZA12 actuators get controlled by the PZC200 controller either directly or via one of the eight output ports of a PZC-SB switchbox.

Motion Principle

PZA12 actuators base on a piezo stepping motor. This motor consists of several multi-leg piezo elements. When

supplying these piezo elements with a special voltage pattern, the legs lift up, move forward and come down again similar to human motion.

A number of these piezo elements are arranged in a circle and coupled by friction to a rotating nut. This nut, in turn, is coupled to a screw that is blocked in rotation and that generates the resulting forth and back motion of the actuator tip.

On average, one cycle, or one step of the piezo motor results in a linear motion of the actuator tip of approx. 160 nm. Further electronic break-down of steps into 16 micro-steps results in an average motion of approx. 10 nm per micro-step.

IMPORTANT NOTE

Because of the friction coupling between the piezo legs and the rotating nut, the actual step size is not 100% accurate or repeatable. It can vary from actuator to actuator and depends further on load, speed, direction of motion, and other parameters. For highly repeatable or accurate positioning tasks an additional external feedback should be used.

PZA actuators feature jam-nut proof hard stops that limit the max./min. travel. In addition, software limits can be set to further reduce the travel range and to avoid motor stalling. Anyhow, motor stalling does not damage the actuator.

Mechanical Compatibility

The PZA12 has a 0.375" x 40 pitch threaded shaft that is compatible with many Newport and other manufacturers mounts and manual stages. With this common interface PZA12 actuators can directly replace manual adjustment screws in many existing setups and provide a huge variety of combinations. A mounting nut and wrench is included with each actuator. For a complete list of Newport compatible mechanics, please refer to the latest Newport catalog or the Newport web page (www.newport.com).

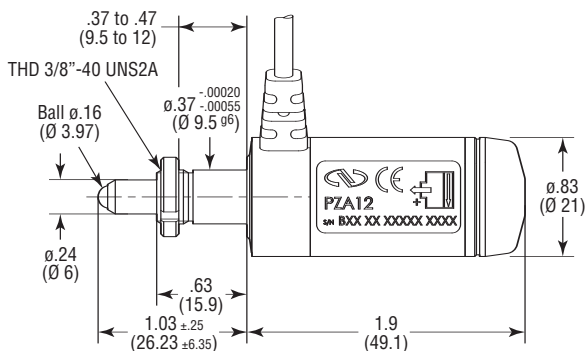

Figure 6: Dimensions, PZA12 Linear Actuator.

PZA12 Design Details

Base material	Aluminum
Drive mechanism	Direct-drive non-rotating lead screw, no gear
Feedback	Open loop, no encoder
Limit switches	Fixed, jam-nut proof hard stops limit max./min. travel
Origin	None
Motor	Non-resonant piezo micro-stepping motor
Average full-step length	Approx. 160 nm depending on load, speed and other parameters, 16 micro-steps per full-step
Cable length	3 m (10 ft)
Weight	0.13 kg (0.29 lb)
Environmental	See NanoPZ system specs, section 2.8
	PZA12 Specifications
Travel	12.5 mm (0.49")
Motion sensitivity	30 nm
Max. speed	0.2 mm/s at full load
Higher speeds possible at lower load	
Axial load capacity	50 N

2.3 PZC200 Controller/Driver

The **PZC200** is an integrated, single-axis, piezo motor controller/driver. It is designed to be hand held but also provides through-holes for bolting to an optical table with a 1" or 25 mm grid of mounting holes.

Used by itself, the PZC200 provides easy and affordable means to control a single PZA12 actuator. Use of an external **PZC-SB switchbox** allows a single PZC200 to control up to eight PZA12 actuators, one channel at time.

Two **primary control modes** are selectable whether or not a switchbox is used: **Local** (manual control) or **Remote** (computer control). Selection of Local or Remote is by pressing the knob of the PCZ200. The control mode is indicated by the color of a tri-color LED. Remote is the default mode at power-up. For details on Local operation, see Section 4 of this manual.

In **Local mode**, the rotary knob at the front of the PZC200 is turned to select one of seven (7) speed settings for each direction plus a rest position. Rotate the knob in one direction, and the actuator moves in that direction. Rotate the knob in the other direction, and the actuator moves in that other direction. The farther the knob is rotated, the faster the actuator moves. The knob is spring-loaded and returns to its zero point when released, thus stopping motion.

Remote (computer) control makes use of the PZC200's digitally addressable RS-485 port, which can be interfaced to a COM port or USB port of a PC. The interface is provided by an RS-485 to RS-232 converter, an optional RS-232 to USB converter, an optional 1x5 RS-485 junction box, plus cables, all available from Newport. In Remote mode, the PZC200 accepts and executes ASCII commands. These can be issued in two primary ways:

NanoPZ-Util software, distributed on CD with each PZC200. For details, see Section 5 of this manual.

Other user-written software that issues and receives ASCII commands, as documented in Section 6 of this manual.

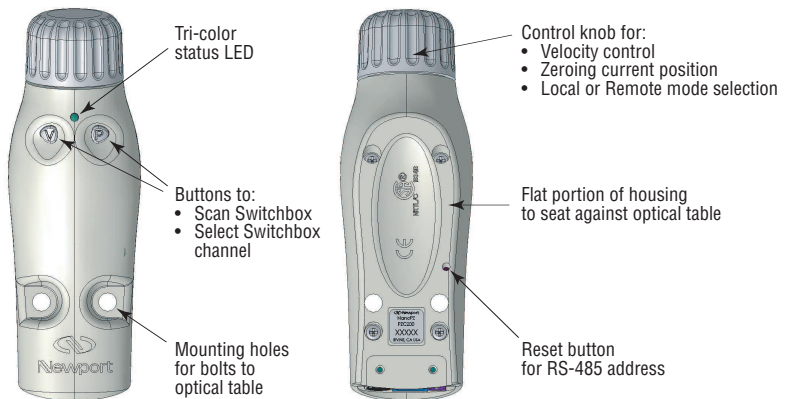
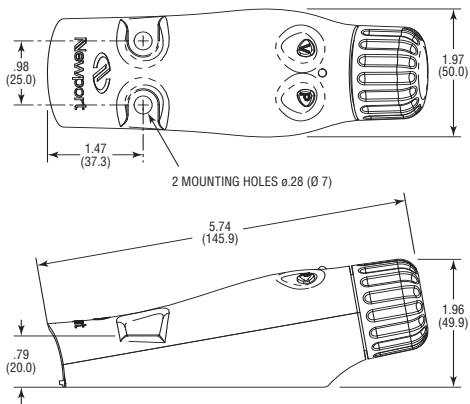

Figure 7: PZC200 top and bottom views.

PZC200 Specifications

Number of controlled axes	1 without PZC-SB switchbox 8 with PZC-SB switchbox
Operating modes	Local (manual) control mode. Remote (computer) control mode.
toggling between local and remote control	Pressing down on control knob.
Controls, Local (manual) mode	Rotate knob to adjust speed. Select active switchbox channel. Toggle between local and remote mode. Set current position to zero
Controls, Remote (computer) mode	ASCII commands I/O via RS-485 port.
Motion commands	Micro-steps, 1 micro-step equals approx. 10 nm of linear motion of a PZA12 depending on load, speed and other parameters. Important: Step size is not 100% accurate or repeatable, see section 2.2.2 for details.
Power requirements	When driving actuator: 0.6 A @ 15 Vdc In standby mode: 0.1 A @ 15 Vdc
Compatible devices	PZA12 piezo motor actuator.
Connectors	Coaxial mini jack for power input 6-position, 4-wire RJ11 jack for RS-485 6-pin mini DIN, female, to actuator
Dimensions (W x D x H)	50 x 150 x 50 mm (2" x 6" x 2")
Weight	0.250 kg (0.55 lb)
Environmental	See NanoPZ system specs, section 2.8



2.4 PZC-SB Switchbox



Figure 8: PZC-SB Switchbox, Front and Side.

The PZC-SB switchbox is an intelligent multiplexer (or switch) which allows one PZC200 controller to drive up to eight PZA12 actuators, one channel at a time. The controller mode can be either Local or Remote mode.

In Local mode, the channel is selected by using the V and P buttons on the PZC200. Pressing the P (right) button increments the selected channel, pressing the V (left) button decrements the selected channel. When pressing the V and P buttons simultaneously for about 2 seconds, the controller scans all eight channel positions of the PZC-SB to learn which channels are connected. Following the scan, the PZC200 will activate only those channels that had an actuator connected during the scan and will skip those channels that had no actuator connected.

In Remote mode, the channel is selected under computer control. In either mode, the status of each channel is indicated by the color of a bank of tri-color LEDs labeled 1-8.

When used, switchbox serves as the connection hub between the power supply, computer (if applicable), and actuators. The controller detects the presence of the switchbox and automatically enables or disables functionalities as required.

Power: The side of the switchbox features two coaxial mini jacks, one labeled with a symbol for power in, one labeled Controller.

RS-485 I/O: In Remote mode, the switchbox communicates with the computer via a first RS-485 cable, and in turn communicates with the controller via a second RS-485 cable. The side of the switchbox features two RJ11 jacks, one labeled PC, one labeled Controller. In Local mode, only the RS-485 cable to the controller is used.

Drive Signals: The switchbox can drive up to eight PZA12 actuators, and in turn is driven by the controller. The back of the switchbox features eight female 6-pin mini-DIN connectors for actuator cables. The side of the switchbox features a single female 6-pin mini-DIN connector for connection to the controller.

PZC-SB Specifications

Controller input channels	1 (multiplexed by switchbox)
Actuator output channels	8 (only channel active at a time)
Power requirements	15 Vdc, 40 mA
Channel status indication	One tri-color LED per channel
Case dimensions (H x W x D)	35 x 182 x 151 mm (1.4" x 7.2" x 5.9")
Case material	Aluminum, painted.
Connector for power input	Coaxial mini jack, positive center.
Connector to computer (if used)	6-position, 4-wire RJ11 for RS-485 I/O.
Connectors to actuators	8 connectors, 6-pin mini-DIN, female.
Connectors to controller	6-position, 4-wire RJ11 for RS-485 I/O. Coaxial mini jack, positive center, for power. 6-pin mini-DIN, female, for drive signal.
Cables to controller	NSC-PSC3: 3 m (10 ft) power cable. 15769-02: 1.8 m (6 ft) driver cable. NSC-CB2: 1.8 m (6 ft) RS-485 cable.
Environmental	See NanoPZ system specs, section 2.8

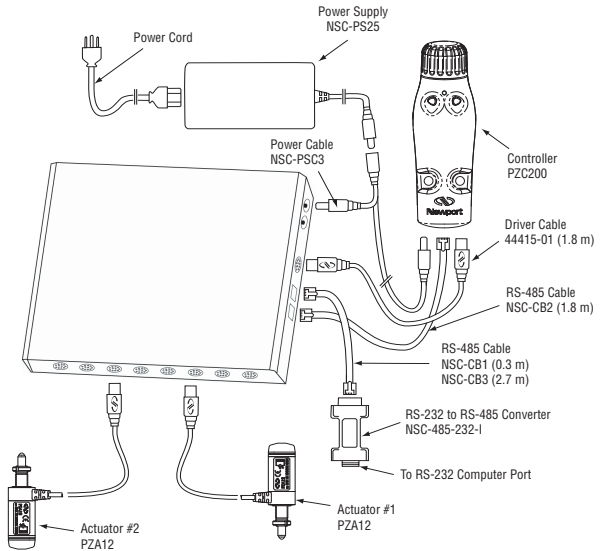

Figure 9: Switchbox Connections.

2.5 NSC-PS25 Power Supply

The NSC-PS25 is a switching power supply designed to drive up to 7 PZC200 controllers, either directly or through a PZC-SB switchbox. Input power can be 90-246 Vac, 47-63 Hz. Output power is 15 Vdc, 4.6 A max.

The NSC-PS25 comes with a 3 m (10 ft) DC power output cable, which is terminated by a coaxial DC power output connector with a 5.5 mm outer ground and a 2.5 mm positive center. This connector can be plugged directly into the power jack of a PZC200 controller or split cable NSC-PSC3, which will then in turn power the controller. The connector can also be plugged into a power cable which branches power to two (2) DC power output connectors. By daisy chaining branching power cables, it is possible to power multiple controllers or switchboxes from the same supply.

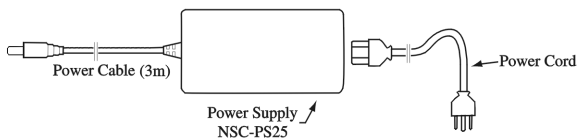

Figure 10: NSC-PS25 Power Supply to One load.

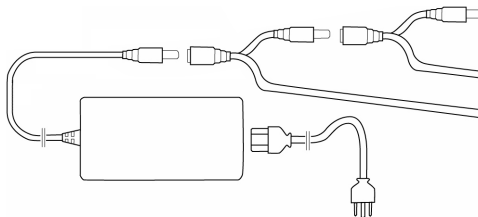

Figure 11: NSC-PS25 Power Supply to Multiple Loads.

NSC-PS25 Specifications

Input voltage	90-246 Vac
Input current, max	1.5 A
Output voltage, nominal	15 Vdc
Output current, max	4.6 A
Supply efficiency	85% (switching type)
Case size (H x W x L)	30 x 58 x 132 mm (1.2" x 2.3" x 5.2")
Length of DC power output cord	3 m (10 ft)
DC power output connector	Coaxial, 5.5 mm outer ground, 2.5 mm positive center.
DC power output branching cables (optional) NSC-PSC1	1 m (3.3 ft), two DC power output connectors
(optional) NSC-PSC3	3 m (10 ft), two DC power output connectors
Environmental	See NanoPZ system specs, section 2.8

2.6 NSC-JB RS-485 Junction Box

The NSC-JB is a passive junction box which allows a single 6-position, 4-wire RJ11 jack to be branched into up to five jacks. By using a single NSC-JB, a single NSC-485-232-I converter connected to a computer COM port can command up to five digitally addressable PZC200 controllers. NSC-JB junction boxes can also be daisy chained to increase the number of controllers. The theoretical maximum number of controllers connected to a single RS-485 line is 32.

Physically, the NSC-JB consists of a white plastic case with five RJ11 jacks, plus a 3.6 m (12-foot) cable terminated by an RJ11 plug. Two mounting ears are provided. All like pins are wired in parallel, with no active components.



Figure 12: NSC-JB RS-485 Junction Box.

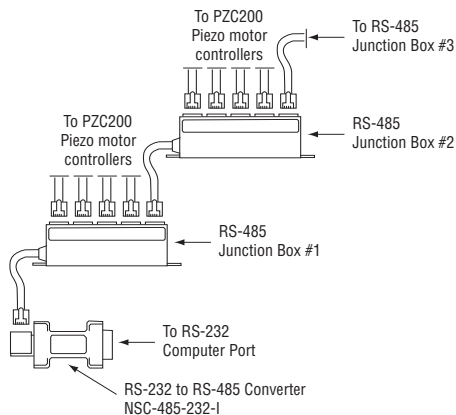

Figure 13: Branching with Multiple RS-485 Junction Boxes.

NSC-JB Specifications

Input connector (computer side) 6-position, 4-wire RJ11 plug

Output connectors (controller side)

Five 6-position, 4-wire RJ11 jacks

Signal processing

None. Device is passive.

Environmental

See NanoPZ system specs, section 2.8

2.7 NSC-485-232-I RS-485 to RS-232 Converter

The NSC-485-232-I is a line-powered, half-duplex, RS-485 to RS-232 converter, which allows the RS-232 COM port of a computer to command one or multiple PZC200 controllers via a single RS-485 line. A 6-position, 4-wire RJ11 jack is on the controller side. A female DB9 connector is on the computer side.

Normally the converter is plugged directly into the computer and is secured to the computer with two connector screws. As an alternative, the converter can be attached to the computer by means of a straight-through serial data cable (readily available in computer stores) with a male DB9 connector on one end and a female DB9 connector on the other end.



Figure 14: NSC-485-232-I Converter.

NSC-485-232-I Specifications

Input connector (RS-232 side)	DB9 connector, female
Output connector (RS-485 side)	6-position, 4-wire RJ11 jack
Power source	RS-232 handshake lines
Dimensions (H x W x L)	23 x 33 x 76 mm (0.9" x 1.3" x 3.0")
Environmental	See NanoPZ system specs, section 2.8

2.8 NanoPZ System Environmental Specifications

CAUTION



The PZA12 actuator and PZC200 piezo motor controller are high-precision laboratory instruments. Only use and store in a clean laboratory environment. Avoid mechanical shock.

Max. operating temperature	5 °C to 40 °C
Recommended operating temperature	20 °C to 25 °C
Operating relative humidity	< 85%, non-condensing
Storage temperature	0–60 °C
Storage relative humidity	< 85%, non-condensing
Altitude	< 2,000 m (6,562 feet)
Installation category	II
Pollution degree	2
Use location	Indoor use only

3.0 Getting Started

3.1 Unpacking and Handling

It is recommended that the NanoPZ system components be unpacked in your lab or worksite, rather than at the receiving dock. Unpack the system carefully, as small parts and cables are included. Inspect the box carefully for loose parts before disposing of the packaging.

Save the packaging material in case you ever need to ship your equipment.

3.2 Inspection for Damage

The NanoPZ system components have been carefully packaged at the factory to minimize the possibility of damage during shipping. Inspect the box for external signs of damage or mishandling, and inspect the contents for damage. If there is visible damage to the equipment upon receipt, inform the shipping company and Newport Corporation immediately.

WARNING



Do not attempt to operate this equipment if there is evidence of shipping damage or if you suspect shipping damage. Damaged equipment may present additional hazards to you. Contact Newport technical support for advice before attempting to plug in and operate damaged equipment.

3.3 Inventory of Parts

Verify that you have received all of the system components that you have ordered. Refer to the connection diagrams in this manual to verify that you have ordered and received all of the components that you will need.

The following is a list of parts included with the PZC200-KT Piezo motor actuator and controller kit:

- 1 x PZC200 controller.
- 1 x PZA12 actuator.
- 1 x NSC-PS25 power supply with AC power cord.
- 1 x NSC-PSC3 DC power cable, 3-meter.
- 1 x User's manual.
- 1 x CD-Rom with utility software.

If you are missing any hardware, have questions about the hardware that you have received, or need to order additional hardware, please contact Newport.

3.4 Interconnecting Components

A NanoPZ system can range from simple to complex. A simple system may consist of one PZA12 actuator, one PZC200 controller, and one NSC-PS25 power supply. Complex systems may include multiple PZC-SB switchboxes and multiple PZC200 controllers powered by the same or several power supplies, commanded by the same computer via RS-485.

The following are some key points of understanding for the more complex systems:

Power Branching

The NSC-PS25 power supply comes with a DC power output cord, which can be plugged into a PZC200 controller or split cable NSC-PSC3. Multiple controllers or switchboxes can be powered by the same supply by daisy-chaining branching power cords. A single supply can power up to 7 controllers that are simultaneously driving actuators.

RS-485 Branching

When an NSC-JB RS-485 junction box is used, up to five PZC200 controllers or PZC-SB switchboxes can be connected to the same RS-485 line and be addressed digitally from the same computer COM port. Junction boxes can be daisy chained. For computer control, an NSC-485-232-I converter is always required to convert the RS-232 signal of the computer to the RS-485 signal. This converter is normally attached to the computer COM port. When a switchbox is used with computer

control, the switchbox is connected via a first RS-485 cable to the converter and via a second RS-485 cable to the associated controller. When a switchbox is used without a computer, there still has to be an RS-485 cable between the switchbox and controller so that these can exchange data.

A PZC-SB switchbox always acts as a connection hub between the associated controller, actuators, and computer (if any). The switchbox can only drive one actuator at a time under control of a single controller, and it does not materially add to power consumption. There always has to be a set of three cables between the switchbox and its associated controller:

- a) **Controller/Switchbox cable:** 1.8 meter (6 ft) cable with two male 6-pin mini-DIN connectors, P/N 15769-02.
- b) **RS-485 data cable:** 1.8 m (6 ft) cable with two 6-position, 4-wire RJ11 connectors, P/N 15769-02.
- c) **DC power supply cable:** 3 m (10 ft) extension cable with a male coax power connector on one end and a female coax connector on the other end, P/N NSC-PSC3.

Please refer to the illustrations below for examples of connected systems. Only apply power after you have interconnected all system components and have studied the chapter 4 of this manual entitled “Local Operation”.

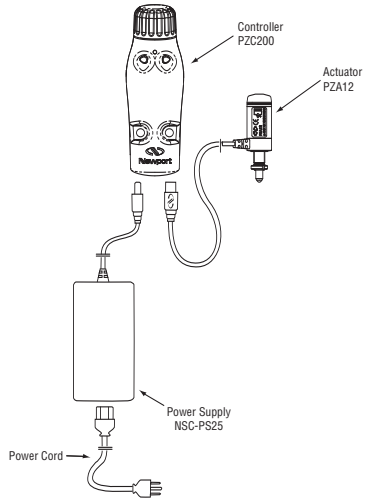

Figure 15: Connections 1 Controller and 1 Supply.

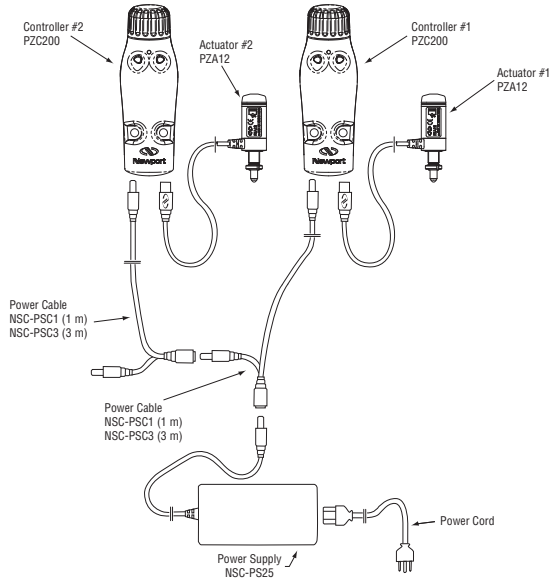

Figure 16: Connections 2 Controllers and 1 Supply.

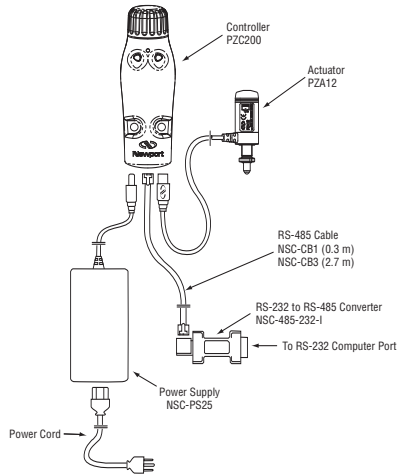

Figure 17: Connections 1 Controller, 1 Supply and Computer Control.

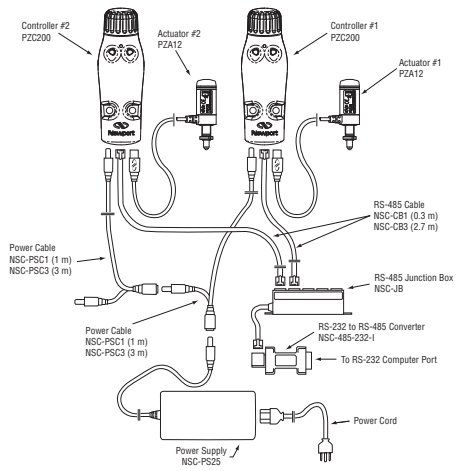

Figure 18: Connections 2 Controllers, 1 Supply and Computer Control.

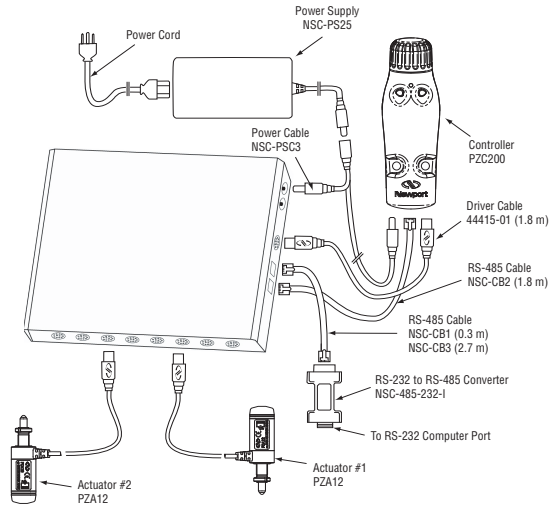

Figure 19: Connections 1 Controller, 1 Switchbox and 2 Positioners.

4.0 Local Operation

4.1 Operating Modes

The PZC200 controller has two operating modes: Local (manual) mode and Remote (computer) mode.

At power up, the Controller will default into remote mode. In remote mode the controller will respond to computer communication only and the speed adjustment knob is disabled. In local mode, the speed adjustment knob is enabled and the computer communication is disabled.

Toggleing between local and remote mode is done by pressing the control knob of the PZC200. The control mode is indicated by the color of a tri-color LED, see section 4.3.1 for details.

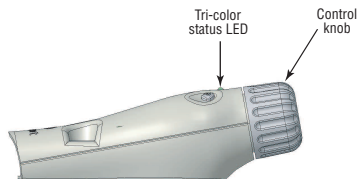

Figure 20: PZC200 side view.

4.2 Local (Manual) Control

Selection of Remote or Local mode

Press the control knob to toggle between Local and Remote. The new selection will only become effective after any ongoing motion has stopped. In Remote mode (yellow LED), the controller responds to computer commands only, and the control knob is disabled. In Local mode (green LED), the control knob is enabled, and computer commands are disabled.

Zeroing the actuator position

Pressing the control knob for longer than 2 sec will set

the current actuator position to 0 and will clear the error of the controller, if allowed by hardware. This function is of main use in combination with remote mode. It also resets the current positions with respect to the software limits.

Scanning of switchbox channels

When a PZC200 is connected to a switchbox, it must first learn which switchbox channels are connected and store this information in non-volatile EEPROM. Simultaneously press down the V and P buttons for 2 seconds, and the controller will scan all eight channel positions. The 8 LEDs of the switchbox will light up in sequence. Following the scan, the LED for each connected channel except one will be yellow. The LED for the one selected channel will be green if there is no problem or red if there is an error or problem, such as the actuator is at its limit of travel.

Selection of switchbox channel

Press the V (left button) to decrement and P (right button) to increment the active switchbox channel. The LED associated with the active switchbox channel will turn green (no problem) or red (error or problem encountered). When toggling the switchbox channels, the PZC200 will skip those channels that had no PZA12 connected during the last scan.

Moving the actuator

Simply turn the control knob in the forward or reverse direction, and let go to stop motion. There are seven speed settings for each direction. As the knob is turned farther in either direction, the velocity will increase for that direction. The knob is spring loaded, and the resting position corresponds to zero speed. The speed settings are part of the default setting and can not be modified.

Resetting RS-485 bus address

Use a small diameter rod to press the reset button on the back of the controller. This will reset the RS-485 bus

address of the controller to its factory default setting of zero (0) so that the controller can be recognized as not initialized by the NanoPZ-Util utility software. Once a desired RS-485 bus address has been entered, the controller can then be digitally addressed in Remote mode using either the NanoPZ-Util utility software or ASCII commands.

NOTE

The reset button must be pressed during a 3-second period to restore the RS-485 address.

4.3 Reading the LED Status Lights

LED Indicator on PZC200 Controller

A tri-color LED adjacent to the control knob indicates the controller operating mode and operating conditions:

LED	YELLOW	GREEN	RED
Solid	REMOTE mode, not in motion	LOCAL mode, not in motion	Error Condition
Blinking	REMOTE mode, in motion	LOCAL mode, in motion	

LED Indicators on PZC-SB Switchbox

A bank of eight tri-color LEDs on the front panel of the switchbox indicates the status of each channel:

LED Status	GREEN	RED	YELLOW	OFF
Connected and selected	Solid			
Disconnected and selected		Solid		
Connected and unselected			Solid	
Disconnected and unselected				Off

5.0 Utility Software

5.1 Overview

The NanoPZ-Util utility software provides computer access to the most commonly used PZC200 controller functions, including changing controller configuration, monitoring status, and issuing move or jog commands. This program is distributed on CD ROM with the PZC200 controller.

5.2 RS-232 Communications Setup

Cabling: For computer control, a PZC200 controller or a PZC-SB switchbox has to be connected to the RS-232 COM Port of the PC via an RS-485 to RS-232 converter, Model NSC-485-232-I. Please refer to section 3 for hookup diagrams. The converter is normally secured directly to the computer, but a straight-through serial data cable with a male DB9 connector on one end and a female DB9 connector on the other end can also be used to connect the converter and PC.

COM Port Setup

19200 bps, 8 data bits, no parity, 1 stop bit, xON / xOFF flow control.

Handshake Protocol

Handshaking between the host computer and controller is automatically provided by the utility software. The paragraph below is for background purposes only.

To prevent buffer overflow when data is transferred to the PZC200 input buffer, a CTS/RTS hardware handshake protocol is implemented. The host computer controls transmission of characters from the controller by enabling a Request To Send (RTS) signal once the controller's Clear To Send (CTS) signal is ready. Before sending any further characters, the controller waits for a CTS from the host computer. As soon as its command buffer is full, the controller de-asserts CTS. Then, as memory becomes available because the controller has read and executed commands in its buffer, it reasserts the CTS signal to the host computer.

5.3 Software Installation

The utility program allows computer control of most features available in the PZC200 controller. It is designed to run on a Pentium-class PC with a minimum of 64 MB of RAM and Windows 98, 2000, NT or XP.

To install the utility program, load the distribution CD and double-click on *NanoPZutilsetup.exe*. The program will give you the option of where to load the files, or you can use the default directory:

C:\Program Files\Newport\NanoPZ-Util.



After installation is complete, open the NanoPZ Utility by double-clicking on the newly created icon (shown to the left) on your desktop. The Set Communication Port window will open. Enter the Port # to which the controller is connected, such as Com4, press Open (a message Communication “COM4 is opened” appears), and then press the OK button.



Figure 21: Set Communication Port Screen.

5.4 Controller Initialization

Connect a controller to the specified port. If the program finds that the controller is not initialized (controller address equal to zero as shipped from the factory), the *Initialize Controller* window (shown below) will open. Type the desired unique address (1–255) into the *Controller Address field*, then press OK.

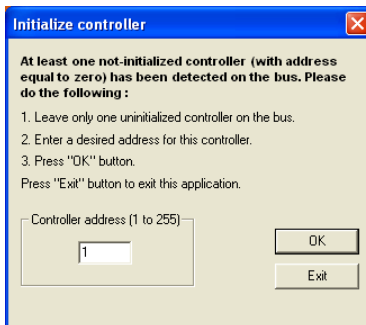

Figure 22: Initialize Controller Screen.

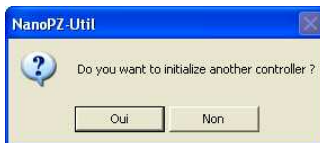

Figure 23: Initializing Another Controller Screen.

After initializing each controller, the *Initialize Controller?* screen opens, asking if you want to initialize another controller. If you do, plug in the next not-initialized controller and press the YES button. The *Initialize Controller* window will open again, allowing you to enter an address for that controller. Note that only one not-initialized controller may be connected to the network at a time for initializing.

5.5 Network Scan

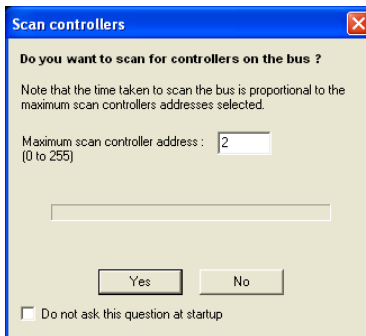

Figure 24: Scan Controllers Screen.

After all controllers have been initialized, the Scan Controller window (shown above) will open. Enter the maximum address to scan for, then press the Yes button. The software will then scan the bus, find any controllers, and find any switchboxes connected to them. It will also discover and identify any PZA actuators.

Note that while the highest possible address is 255, the time to scan the bus is proportional to the actual number of addresses to be scanned. If the check box at the bottom left of the screen is checked, the program will not scan the bus the next time the program is started.

Following the scan, the main screen will open.

5.6 Working with the Main Screen

After the bus scan, the Main Screen of the *NanoPZ-Util* software appears:

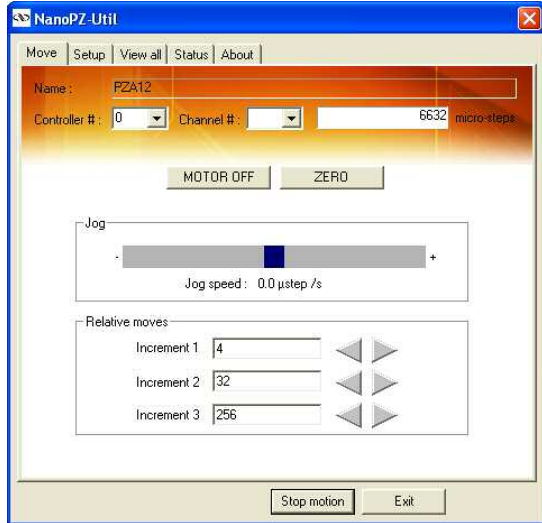

Figure 25: Move Screen.

Navigation through the screen is by means of five tabs (*Move, Setup, View all, Status, About*). With all five tabs, the top 25% of the screen remains the same, as follows:

The headline at the top shows the name of the channel as assigned by the user under the *Setup* tab (PZA12 in this example).

The *Controller #* field shows the bus address of the controller. You can select a different controller by typing in a different number or by selecting from the list.

The *Channel #* field shows the active channel number of the switchbox associated with the controller to the left. When no switchbox is used, this field is always blank. A different switchbox channel can be selected by typing in a different number or by selecting from the list of

available channels.

The *micro-steps* field shows the current position in micro-steps. For further information about the step size, please refer to section 2.2.2.

The five tabs (*Move, Setup, View all, Status, About*) bring up five sub-screens, which are explained in the next chapters.

The *Stop Motion* button at the bottom of the screen stops motion for that channel.

The Exit button exits *NanoPZ-Util*.

NOTE

Only one PZC200 controller can be communicated with at any given time by *NanoPZ-Util* software. Control as well as the Stop Motion button apply only to the selected controller and controller channel.

Move Tab

From the move screen (see Figure 25) you can access to the following functions:

Motor ON/Motor OFF: To enable any motion, you must turn the Motor ON. When you don't want to do any further motion on that actuator, you might want to turn the motor OFF.

ZERO: Sets the current position to zero. This function is useful for instance for referencing the actuator with respect to its software limits.

JOG: Grab the blue bar with your mouse and move it right or left to start a jog motion in positive (right) or negative (left) direction. The farther you move the bar, the faster the actuator moves. There are 7 predefined jogging speeds in each direction. The current jog speed gets displayed under the speed bar. When you release the blue bar, the actuator stops motion.

RELATIVE MOVES: Provides three fields with relative

positions in micro-steps. Press on the corresponding “<” or “>” button, and the actuator will make that relative move in the positive (“>”) or negative (“<”) direction from its current position.

Setup Tab

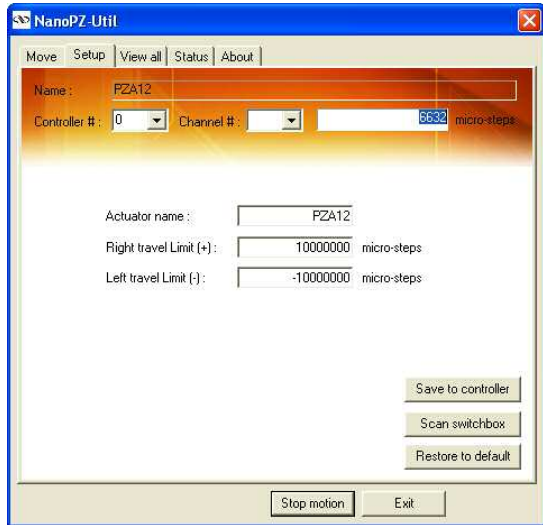

Figure 26: Setup Screen.

The Setup tab brings up three data fields, which apply to the selected controller # and channel #:

Actuator name: Sets the name for the current select controller # and channel #: Up to 10 characters are allowed, but no space, tab or “;”

Right travel limit (+): Sets the value of the positive software limit, or right allowed range of travel. This value must be greater than 0.

Negative travel limit (-): Sets the value of the negative software limit, or left allowed range of travel. This value must be less than 0.

The function of the other 3 buttons are as follow:

- Save to Controller* Press to save any setup changes into the controllers non-volatile EEPROM.
- Scan Switchbox* Press if you have added or disconnected an actuator to the selected switchbox. This will initiate a new bus scan, followed by an updated View all tab screen.
- Restore to default* Press to load default values into non-volatile EEPROM of the controller.

View all Tab

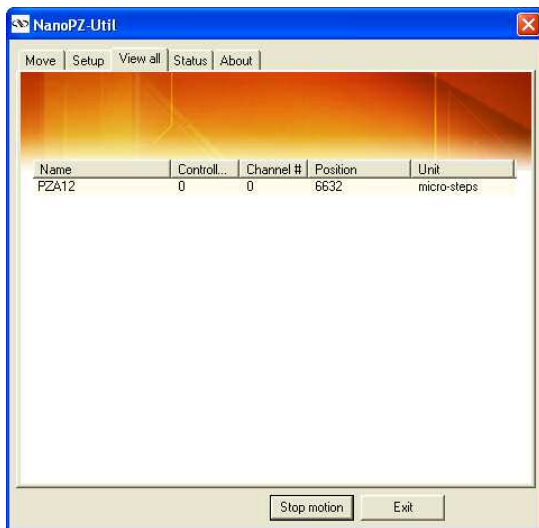

Figure 27: View all Screen.

The View all screen shows at a glance which controller #'s are on the bus and which have an associated switchbox with channel #'s. In case of a controller with no switchbox, the channel # is always 0. In case of a controller with a switchbox, there may be 1 to 8 lines for that controller # with channel # running from 1 to 8. Also shown is the name of actuator associated with each controller # and channel # as assigned by the user in the *Setup* screen.

Status Tab

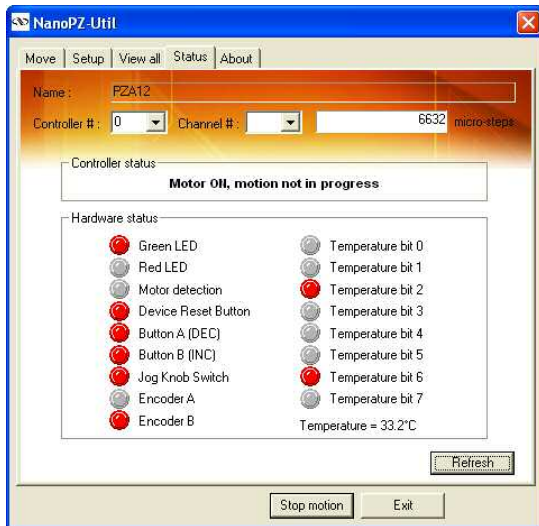

Figure 28: Status Screen.

The Status tab shows the controller and hardware status. The controller status gets displayed by a short text message. The hardware status gets displayed by 17 light buttons for the status of the actual LEDs, limit switches, buttons, encoders, and controller temperature. A red button indicates High, a gray button indicates Low. These buttons refer to some of the information that gets also returned by the PH *Get Hardware Status* command. For further details, please refer to the PH command in section 6.1.4

About Tab

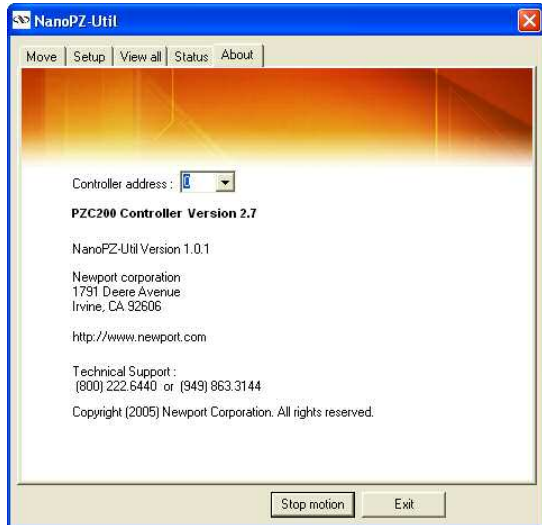

Figure 29: About Screen.

Pressing the *About tab* brings up a screen which shows the current versions of the software and controller firmware as well as Newport contact information for technical support.

6.0 ASCII Command Set

6.1 Command Set Introduction

This section describes the supported two-letter ASCII commands that may be used to configure and operate the PZC200 controller in Remote mode (Yellow LED), when the controller is connected to a computer either directly or via a PZC-SB switchbox. These commands work with LabView, Visual Basic, C++, or any other computer application that can issue ASCII commands via a computer COM port. For instance Newport's NanoPZ-Util utility program, described in the previous section of this manual, utilizes these commands.

Address Field

Since multiple PZC200 controllers may be placed on the RS-485 Bus or be connected to a PZC-SB Switchbox, each controller has an assigned address *xx* (or controller number) from 0 to 255. By decoding the address field of the incoming message, the controller can determine if the message is intended for it. This address *xx* needs to be prefix to each command. If the address does not match a specific controller, that controller ignores the message. If the address is missing, there is no error message, but the address is implied to be 0. If the address is out of range, i.e., larger than 255, there is no error message, and no controller will respond.

Set or Query Commands

Commands are either Set or Query commands. A Set command changes a setup parameter or initiates an action. A Query command, which is always terminated by a question mark, reads back setup or status information. When the controller responds to a query, it first sends out the received command and then follows with the requested information. For example, if *234VE?* is sent to controller 234, it may respond with *234VE? 1.0* depending on installed firmware version.

Saving Settings to Non-Volatile Memory

When a setting is changed using a Set command, the new setting is written to RAM and is implemented immediately. When power is removed and re-applied, the change is lost unless the setting has been saved to non-volatile memory using the **SM** command. Always execute an **SM** command if you want changed parameters to be saved.

Motion cCommands

All motion related commands are referenced in units of micro-step. One micro-step equals a linear displacement of the PZA12 actuator tip of approx. 10 nm.

However, because of the special nature of the piezo motor used in the PZA12, the actual step length can vary from actuator to actuator and depends further on load, speed, direction of motion, and other parameters. For highly repeatable or accurate positioning tasks an additional external feedback should be used.

For further details on the motion principle and step length, please see also section 2.2.2.

6.2 Command Set Summary

Command Name	Short Description	Command	Query “?”
BX	Scan switchbox	Yes	Yes
BZ	Restore EEPROM content to default	Yes	No
ID	Actuator description	Yes	Yes
JA	Start jog motion	Yes	Yes
MF	Motor OFF	Yes	No
MO	Motor ON	Yes	No
MX	Select switchbox channel	Yes	Yes
OR	Zero position	Yes	Yes
PH	Get hardware status	No	Yes
PR	Position relative	Yes	No
RS	Reset controller	Yes	No
SA	Set controller address	Yes	No
SL	Set negative (left) travel limit	Yes	Yes
SM	Save settings to non-volatile memory	Yes	No
SR	Set positive (right) travel limit	Yes	Yes
ST	Stop motion	Yes	No
TE	Read error code	No	Yes
TP	Read current position	No	Yes
TS	Controller status	No	Yes
VE	Read controller firmware	No	Yes

6.3 Command Set Details

BX Scan switchbox

Syntax **xxBX** Causes controller **xx** connected to a PZC-SB switchbox to scan channels 1-8 and load a table which indicates which channels are connected to an actuator. After the scan process, if the last selected actuator is not found, the first detected actuator is selected.

If no actuator is found, the selected actuator is set to 0.

xxBX? Reports which switchbox channels from 1-8 are connected to an actuator for controller **xx**. Response is a decimal representation of binary{[actuator8][actuator7]... [actuator1]} where actuator x = 1 if it was connected and 0 if not.

Parameters **xx** Controller number (integer) from 0 to 255.

Example **2BX** Causes controller **2** connected to a PZC-SB switchbox to scan channels.

2BX? Reports which switchbox channels of controller 2 were connected to an actuator during last scan.

For example, the response 2BX 38 would indicate that channels 1,2 and 5 were connected to an actuator ($38 = 2^1 + 2^2 + 2^5$). Bit0 corresponds to channel 1 and bit7 to channel 8.

Errors **No switch box connected:**

Err. 227: Command not allowed.

Rel. Commands **MX** — Select switchbox channel.

ID — Actuator description.

BZ Restore EEPROM content to default

Syntax **xxBZ** Restores all non-volatile EEPROM factory default values for controller **xx**.

Parameters	xx	Controller number (integer) from 0 to 255.
Example	5BZ	Restores factory default settings for controller 5.
Rel. Commands	RS —	Reset controller. The following default parameters are set by the BZ command: <ul style="list-style-type: none"> • Current position: 0 (OR) • Actuator description PZA12 (ID) • Positive software limit: 10000000 (SR) • Negative software limit: -10000000 (SL) • Controller address: 0 (SA) • Switchbox channel. 0 (no switchbox) (MX)

ID Actuator description

Syntax	xxIDnn	Assigns a user-defined name to an active actuator connected to controller xx (directly or via a switchbox).
	xxID?	Reads back user-defined name of active actuator of controller xx .
Parameters	xx	Controller number (integer) from 0 to 255.
	nn	User-defined actuator name up to 10 ASCII characters long, such as <i>PZA12-I</i> . Tab, and space are automatically removed; “;” is not allowed.
Example	3IDaxisY	Set description for active actuator on controller 3 to <i>axisY</i> .
	3ID?	Returns description of active actuator of controller 3.
Errors	nn with more than 10 characters:	Err. 7: Parameter out of range.
	nn missing:	Err. 38: Command parameter missing.
Rel. Commands	MX —	Select switchbox channel.
	BX —	Scan switchbox.

JA Start jog motion

Syntax **xxJAnn** Starts a jog motion with speed setting **nn** for controller **xx**. If motion is in progress, command is ignored and an error message is generated. For details about step length, please refer to sections 2.2.2 and 6.1.4

xxJA? Reads back current jog speed setting from controller **xx**.

Parameters **xx** Controller number (integer) from 0 to 255.

nn Jog setting (integer) from 0 to ± 7 .

nn value	Jog Speed
0	0 μ step/s
± 1	± 3.2 μ step/s
± 2	± 16 μ step/s
± 3	± 80 μ step/s
± 4	± 400 μ step/s
± 5	$\pm 2,000$ μ step/s
± 6	$\pm 10,000$ μ step/s
± 7	$\pm 48,000$ μ step/s

Example **5JA-5** Starts jog motion at $-2,000$ μ step/s for controller 5.

5JA? Returns last set jog speed of controller 5.

Errors Driver fault:

Err. 2: Driver fault (thermal shut down).

nn out of range:

Err. 7: Parameter out of range.

No motor:

Err. 8: No motor connected.

nn missing:

Err. 38: Command parameter missing.

Motor off:

Err. 213: Motor not enabled.

No actuator connected to nn channel at last scan:

Err. 214: Invalid axis.

Command during motion:

Err. 226: Command not allowed during motion.

Rel. Commands	MO — Motor ON.
	ST — Stop motion.
	MF Motor OFF
Syntax	xxMF Turns motor off for controller xx .
Parameters	xx Controller number (integer) from 0 to 255.
Example	4MF Turns motor off for controller 4.
Rel. Commands	MO — Motor ON.

	MO Motor ON
Syntax	xxMO Turns motor on for controller xx .
Parameters	xx Controller number (integer) from 0 to 255.
Example	3MO Turns motor on for controller 3.
Errors	Driver fault:
	Err. 2: Driver fault (thermal shut down).
	No motor connected:
	Err. 8: No motor connected.
Rel. Commands	MF — Motor OFF.
	ST — Stop motion.

	MX Select switchbox channel
Syntax	xxMXy Causes controller xx to select switchbox channel y . Upon execution, the controller loads settings from its non-volatile memory for channel y . If there is no switchbox or a motion is in progress, the command is ignored and an error message is generated. NOTE: It is recommended to set motor off (MF) before switching to a new channel to avoid actuator drift.
	xxMX? Returns active channel number for controller xx . Returns 0 when no channel is active.
Parameters	xx Controller number (integer) from 0 to 255.
	y Switchbox channel (integer) from 1 to 8.

Example	4MX8	Selects switchbox channel 8 connected to controller 4, and loads appropriate settings from its non-volatile memory.
	4MX?	Returns 4MX 8 for the above example, where 4 is the controller number and 8 is the current selected switchbox channel.
	Errors	y other than 1-8: Err. 7: Parameter out of range. Y missing: Err. 38: Command parameter missing. Actuator y not in the table: Err. 214: Invalid axis. Command during motion: Err. 226: Command not allowed during motion. No switch box: Err. 227: Command not allowed.
Rel. Commands	BX	— Scan switchbox.
	SA	— Set controller address.
	OR	Zero position
Syntax	xxOR	Set position of active actuator of controller xx to 0. When a motion is in progress, the command is ignored and an error message is generated.
Parameters	xx	Controller number (integer) from 0 to 255.
Example	5OR	Set position of the actuator connected to controller 5 to 0.
	Errors	Motion in progress: Err. 226: Command not allowed during motion.
Rel. Commands	SL	— Set negative (left) travel limit.
	SR	— Set positive (right) travel limit.
	ST	— Stop motion.

PH Get hardware status**Syntax**

xxPH? Returns 32 status bits from controller. These are reported as a decimal number, which needs to be converted to binary.

Bit#	Description
0	LED red
1	LED green
2	EPROM, WP
3	DRS, switch to default address
4	Error motor detection, disconnected
5	-
6	SCL, I2C, Serial clock
7	SDA, I2C, Serial data
8	Ch4b, Curve generation
9	Ch4a, Curve generation
10	Ch3b, Curve generation
11	Ch3a, Curve generation
12	Ch2b, Curve generation
13	Ch2a, Curve generation
14	Ch1b, Curve generation
15	Ch1a, Curve generation
16	OA, jog wheel position
17	OB, jog wheel position
18	ENC, push button on jog wheel
19	INC, increase button
20	DEC, decrease button
21	PGM, Programming mode
22	PGC, In-Circuit Debugger and ICSP programming clock pin
23	PGD, In-Circuit Debugger and ICSP programming data pin
24	Temperature bit 0
25	Temperature bit 1
26	Temperature bit 2
27	Temperature bit 3
28	Temperature bit 4
29	Temperature bit 5
30	Temperature bit 6
31	Temperature bit 7

		Temperature (Celsius) = BYTE / 1024 * 500.
Parameters	xx	Controller number (integer) from 0 to 255.
Example	14PH?	Returns 32 status bits from controller 14 as a decimal number, such as 147843. One way to convert this to binary is to use the Windows scientific calculator. Click on <i>Start > Programs > Accessories > Calculator > View > Scientific > Dec</i> (decimal). Copy and paste in the decimal number, then click on Bin (binary) to display the binary equivalent. The binary bits 0-32 are read from right to left
Rel. Commands	TS —	Controller status.
	TE —	Read error code.
	PR	Position relative
Syntax	xxPRnn	Initiates a move of nn μ steps for controller xx . The speed of the motion depends on the motion length given by nn. For displacements bigger than 192 μ steps, the final position will be rounded to the closest full-step. The command gets not accepted while a motion is in progress. For details about step length, please refer to sections 2.2.2 and 6.1.4
Parameters	xx	Controller number (integer) from 0 to 255.
	nn	Relative position (integer) from -10,000,000 to 10,000,000 μ steps. There are 16 μ steps per full-step.
Example	25PR1000	Initiates relative move of 1000 μ steps for actuator connected to controller 25.
Errors	Driver fault:	
	Err. 2:	Driver fault (thermal shut down).
	nn out of range:	
	Err. 7:	Parameter out of range.
	No motor:	
	Err. 8:	No motor connected.

	nn missing:	
		Err. 38: Command parameter missing.
	Motor off:	
		Err. 213: Motor not enabled.
	Command during motion:	
		Err. 226: Command not allowed during motion.
Rel. Commands	ST	— Stop motion.
	JA	— Start jog motion.
	RS	Reset controller
Syntax	xxRS	Resets processor in controller xx .
<hr/>		
NOTE		
The RS command also resets the controller address to 0.		
<hr/>		
Parameters	xx	Controller number (integer) from 0 to 255.
Example	31RS	Soft-resets controller 31.
	SA	Set controller address
Syntax	xxSAnn	Changes current controller address xx to new address nn .
Parameters	xx	Controller number (integer) from 0 to 255.
	nn	New controller address (integer) from 0 to 255.
Example	0SA14	Changes controller address from 0 to 14.
Errors	nn out of range:	
		Err. 7: Parameter out of range.
	nn missing:	
		Err. 38: Command parameter missing.
	SL	Set negative (left) travel limit
Syntax	xxSLnn	Sets value of negative software limit, or extreme left allowed range of travel. This value must be less than 0. If motion is in progress, command is not accepted and an error message is generated.

Because of the non-repeatable special nature of the PZA12, the software limits can only act as approx. limits. For further details, please refer to sections 2.2.2 and 6.1.4.

	xxSL?	Reports value of negative (left) software limit.
Parameters	xx	Controller number (integer) from 0 to 255.
	nn	Negative software limit (integer) from -10,000,000 to 0 μ steps.
Example	7SL-100	Sets negative software limit to -100 for controller 7.
	7SL?	Reads back negative software limit from controller 7.
Errors	nn out of range:	
	Err. 7:	Parameter out of range.
	nn missing:	
	Err. 38:	Command parameter missing.
	No actuator connected to nn channel at last scan:	
	Err. 214:	Invalid axis error.
Rel. Commands	Command during motion:	
	Err. 226:	Command not allowed during motion.
	JA	— Start jog motion.
	PR	— Position relative.
	OR	— Zero position.
	SR	— Set positive (right) travel limit.
SM	Save settings to non-volatile memory	
Syntax	xxSM	Saves controller configuration settings from RAM to non-volatile EEPROM memory. This command should be issued after modifying settings so that these are not lost when controller is powered off.
Parameters	xx	Controller number (integer) from 0 to 255.
Example	6SM	Saves changes for controller 6 to non-volatile memory.

- Rel. Commands**
- ID** — Actuator description.
 - SA** — Set controller address.
 - SL** — Set negative (left) travel limit.
 - SR** — Set positive (right) travel limit.

SR Set positive (right) travel limit

Syntax **xxSRnn** Sets value of right software limit, or extreme right range of travel. This value must be larger than 0. If motion is in progress, command is not accepted and an error message is generated.

Because of the non-repeatable special nature of the PZA12, the software limits can only act as approx. limits. For further details, please refer to sections 2.2.2 and 6.1.4.

xxSR? Reports value of positive (right) software limit.

Parameters

- xx** Controller number (integer) from 0 to 255.
- nn** Positive software limit (integer) from 0 to 10,000,000 μ steps.

Example **7SR3000** Sets positive software limit to 3000 for controller 7.

7SR? Read back positive software limit from controller 7.

Errors **nn out of range:**

Err. 7: Parameter out of range.

nn missing:

Err. 38: Command parameter missing.

No actuator connected to nn channel at last scan:

Err. 214: Invalid axis error.

Command during motion:

Err. 226: Command not allowed during motion.

- Rel. Commands**
- JA** — Start jog motion.
 - PR** — Position relative.
 - OR** — Zero position.

SL — Set negative (left) travel limit.

ST Stop motion

Syntax **xxST** Stops motion in progress on controller **xx**.

Parameters **xx** Controller number (integer) from 0 to 255.

Example **1ST** Stops motion on controller 1.

Rel. Commands **JA** — Start jog motion.

MO — Motor ON.

PR — Position relative.

TE Read error code

Syntax **xxTEnn?** Returns last memorized error code on controller **xx**, and clears error if it is no more present.

Error Code	Description
0	No error
2	Driver fault (thermal shut down)
6	Unknown command
7	Parameter out of range
8	No motor connected
26	Positive software limit detected
27	Negative software limit detected
38	Command parameter missing
50	Communication Overflow
213	Motor not enabled
214	Invalid axis
226	Command not allowed during motion
227	Command not allowed
240	Jog wheel over speed

Parameters **xx** Controller number (integer) from 0 to 255.

Example **23TE?** Returns code of latest memorized error on controller 23.

NOTE: When it is possible, the error is cleared by this command.

	TP	Read current position
	Syntax	<p>xxTP? Returns the position in micro-steps of the active actuator of controller xx. For details about step length, please refer to sections 2.2.2 and 6.1.4.</p> <p>xxTPnn? When a switchbox is connected, and a switch is done from actuator n1 to actuator n2, the position of n1 is stored.</p> <p>This command returns the latest stored position of the actuator connected to controller xx and switchbox channel nn.</p>
	Parameters	<p>xx Controller number (integer) from 0 to 255.</p> <p>nn Channel 1-8 of a switchbox connected to controller xx, if applicable. This term is only used when there is a switchbox. If nn is omitted, the position is returned for the active actuator associated with controller xx.</p>
	Example	<p>25TP3? Returns position value, in μsteps, of actuator connected to switchbox channel 3 of controller 25.</p> <p>25TP? Returns position value, in μsteps, of active actuator associated with controller 25.</p> <p>NOTE: The controller operates in an “open loop” fashion and it returns the “theoretical” value of the position. Because of the possible sliding of the piezoelectric motor, the actual actuator position may be different from the read-back value.</p>
	Errors	<p>No actuator was connected on nn channel during latest scan:</p> <p>Response xxTPnn?! and Err. 214: Invalid axis.</p> <p>No Switchbox:</p> <p>xxTPnn? will generate Error 227. Invalid command.</p>
	Rel. Commands	<p>JA — Start jog motion.</p> <p>PR — Position relative.</p>

TS controller status

Syntax **xxTS?** Returns a status number for controller **xx**:

Motor ON, motion not in progress	81	Q
Motor ON, motion in progress	80	P
Motor OFF, motion not in progress	64	@

Parameters **xx** Controller number (integer) from 0 to 255.

Example **25TS?** Returns status number for controller 25.

Rel. Commands **MF** — Motor OFF.

MO — Motor ON.

TE — Read error code.

TP — Read current position.

VE Read controller firmware

Syntax **xxVE?** Returns firmware version in *Major.Minor* format.

Parameters **xx** Controller number (integer) from 0 to 255.

Example **3VE?** Returns firmware version of controller 3, such as *1.2*, where *1* is the major and *2* is the minor firmware revision.

7.0 Maintenance & Service



CAUTION

There are no user serviceable parts inside the PZA12, PZC200, and PZC-SB. Work performed by persons not authorized by Newport Corporation will void the warranty.

7.1 Enclosure Cleaning

The NanoPZ system components should only be cleaned with a soapy water solution. Do not use an acetone or alcohol solution, as this will damage the finish of the enclosure.

7.2 Technical Support

This section contains information regarding factory service for NanoPZ system components. The user should not attempt any maintenance or service of the equipment. Any problem that cannot be resolved should be referred to Newport Corporation.

Telephone	1-800-222-6440
Fax	1-949-253-1479
Address	Newport Corporation Service Department 1791 Deere Ave., Irvine, CA 92606
Email	tech@newport.com or istd.service@newport.com
Web Page URL	http://www.newport.com/Support/Technical_Help/ Returns/">http://www.newport.com/Support/Service_and>Returns/

Contact Newport to obtain information about factory service. Telephone contacts number(s) are provided on a Service Form. Please have the following information available:

- Equipment model number (PZA12, PZC200, PZC-SB).
- Equipment Serial Number
- Problem Description (document this by using the Service Form)

If the instrument is to be returned for repair, the user will be given a Return Authorization Number that needs to be referenced in their shipping documentation. Complete a copy of the Service Form shown below and fax it to Newport at the number indicated.



Newport®

Experience | Solutions

**Visit Newport Online at:
www.newport.com**

North America & Asia

Newport Corporation
1791 Deere Ave.
Irvine, CA 92606, USA

Sales

(949) 253-1461 or (800) 222-6440 x31461
e-mail: sales@newport.com

Technical Support

(949) 253-1406 or (800) 222-6440 x31406
e-mail: tech@newport.com

Service, RMAs & Returns

(949) 253-1694 or (800) 222-6440 x31694
e-mail: istd.service@newport.com

Europe

MICRO-CONTROLE Spectra-Physics S.A
1, rue Jules Guesde – Bât. B
ZI Bois de l'Épine – BP189
91006 Evry Cedex
France

Sales & Technical Support

+33 (0)1.60.91.68.68
e-mail: france@newport-fr.com

Service & Returns

+33 (0)2.38.40.51.55