



Operating Manual





Funkwerk Dabendorf reserves the right to modifications in the course of technological progress and deviations from the delivery scope! All rights reserved! Reproduction, in whole or in part, is only permitted with the prior written consent of Funkwerk Dabendorf GmbH!

1 List of contents

1	LIST OF CONTENTS	3
2	LIST OF ILLUSTRATIONS	5
3	INTRODUCTION / FOREWORD	6
4	SAFETY NOTES	7
5	SCOPE OF DELIVERY / PACKAGE CONTENT	8
6	INSTALLATION GUIDE	9
6.1	Determination of required configuration	9
6.1.1	Vehicle	9
6.1.2	Telephone	9
6.1.3	Muting (Radio Muting)	9
6.1.4	Upgrading existing Funkwerk hands-free installations to EGO TALK	9
6.1.5	Add-on speakers / car audio telephone connection	10
6.1.6	Car audio line-in	10
6.2	Installation locations	10
6.2.1	Checking cable lengths	10
6.2.2	Selection of the point of installation for the electronics box	10
6.2.3	Selection of the point of installation for the microphone	11
6.2.4	Selection of the point of installation for the control console	12
6.3	Installation	12
6.3.1	Mounting the electronics box	12
6.3.2	Mounting the microphone	13
6.3.3	Mounting the control console	13
6.4	Connection scheme	14
6.5	Installation of the ISO connecting cable	16
6.5.1	Checking the mute inputs	16
6.5.2	Checking the installation	18

6.5.3	Additional external speakers	18
6.6	Connecting the components to the electronics box	19
6.7	Operational test	21
7	OPERATING MANUAL	22
7.1	Features	22
7.1.1	Overview of features	22
7.2	Symbols	22
7.3	Getting started	24
7.3.1	About Bluetooth® technology	24
7.3.2	On / Off function	25
7.3.3	Coupling	25
7.3.4	Automatic connection	25
7.4	Calling	26
7.4.1	Incoming call	26
7.4.2	Outgoing call	26
7.5	Audio Player	26
7.5.1	Coupling	26
7.5.2	Play / Pause	27
7.5.3	Stop	27
7.5.4	Skip features	27
7.6	Volume	27
8	SERVICE	28
9	SPARE PARTS AND ACCESSORIES	30
10	TECHNICAL SPECIFICATIONS	32
11	CERTIFICATION	32
12	CONFORMITY STATEMENT	33
13	HOTLINE	35

2 List of illustrations

Fig. 01	Scope of delivery	8
Fig. 02	Signal orientation of Bluetooth® antenna	10
Fig. 03	Installation location for electronics box	11
Fig. 04	Installation location for microphone	11
Fig. 05	Installation dimensions of electronics box	12
Fig. 06	Connecting the Mini-ISO-connector	15
Fig. 07	Installation procedure	16
Fig. 08	Type-dependent pin allocation	17
Fig. 09	Plug wiring scheme	17
Fig. 10	Connection system	17
Fig. 11 a/b	Changing power supply wiring	18
Fig. 12	Connecting external loudspeakers	19
Fig. 13	Connecting the electronics box	20

3 Introduction/Foreword

Congratulations on your new EGO!

EGO TALK is the intelligent entry-level solution for telephone use in your car: simple to operate, elegant and compact – with Bluetooth and audio enjoyment, too. EGO TALK has an integrated MP3 playback function for your mobile phone, your iPod™ or any other MP3 Player. Enjoy your favourite tracks on your car's audio speakers, in superb stereo sound.

The installation of your EGO TALK in your car requires specialized knowledge and skills. We therefore recommend that the installation be performed by a qualified professional.

Before installation in your car, please make sure that your mobile phone is fully compatible with EGO TALK. If you are uncertain, please consult your dealer or a qualified workshop. Our service team will also be happy to help you with any information you may require. Further information on compatibility between EGO TALK and various mobile phones can be found on our website.

4 Safety notes

1. **Incorrect installation** – Incorrect installation may lead to damage to the units and/or your car! Specialized knowledge and skills are required for installing the system. We strongly recommend that the system be installed by a qualified professional.
2. **Risk of injury** – Unsuitable installation locations may become a source of injury in an accident situation, or may inhibit the correct functioning of essential safety equipment. Please carefully read the notes in the „Installation“ chapter carefully!
3. **Risk of injury/material damage** – the removal of vehicle lining with sharp or pointed objects may lead to injuries or material damage.
4. **Road safety risk** – Diverted attention can lead to dangerous situations in traffic. Even when using hands-free phone systems, your complete attention must be paid to the current traffic conditions. It is always advisable to avoid phone calls while driving in difficult traffic situations!
5. **Damage to airbags** – An incorrect installation location may cause damage to, or inhibit the correct function of, your airbags. Do not install the components within the deployment area of the airbags!
6. **Insulation damage** – Damaged insulation can lead to equipment and wiring damage. The cables and leads may not be under tension when installed. Install the cables and leads in such a way as to avoid pinching or abrasion.
7. **Polarity and shorting damage** – Cables connected with reversed polarity, or in such a way as to produce a short circuit, can lead to serious damage to your equipment. Before commencing installation, make sure that the car battery is disconnected.
8. **Damage to essential vehicle components** – Essential vehicle components or wiring can be damaged when drilling mounting holes or screwing in self-threading screws. Please make sure there is always sufficient space behind the screw holes and drilled holes!
9. **Interference with on-board electronics** – Despite the extreme protection against interference, incorrect installation can lead to interference with the vehicle electronic systems. Please read the vehicle manufacturer's notes to this effect!
10. **Appropriate use** – This equipment is intended solely for use with mobile telephones in motor vehicles.
11. **Damage caused by inappropriate replacement parts** – Inappropriate spare or replacement parts may lead to malfunctions. Please use only the approved parts listed in the section „Spares parts and accessories“!
12. **Road safety risk** – For your own safety, never initiate the coupling procedure while your vehicle is in motion!

5 Scope of delivery / package content

- [1] Electronics box
- [2] Control console
- [3] Microphone
- [4] ISO-cable for connection to the car electrical system
- [5] Adapter cable
- [6] Self-adhesive pad
- [7] Quick guide
- [8] Safety manual



[1]

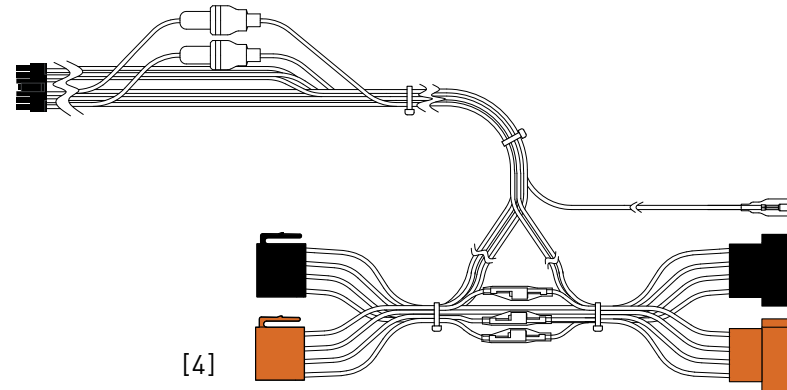

[4]

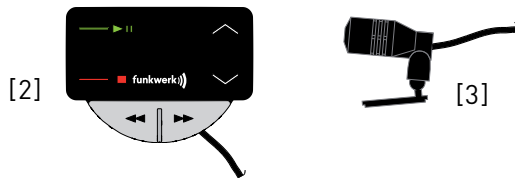

[2]

[3]



[6]

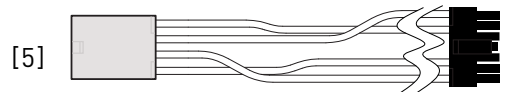

[5]



[7]

[8]

Fig. 01:
Scope of Delivery



PLEASE MAKE SURE THE CONTENT OF THE PACKAGE is complete. If any parts are missing, please don't hesitate to contact our service hotline team: (+1) 858.566.2170, Mon – Fri, 8 AM to 5 PM (PST)

6 Installation guide

6.1 Determination of required configuration

Before installation of your EGO TALK, please note which features and connection options are provided by your car audio system. It is advantageous when your audio has the following: a muting function, phone input and line-in. You can find out which of these input options your audio system has in the documentation provided.

6.1.1 Vehicle

The hands-free system may only be installed in vehicles with a negative grounded, 12 V electrical system. If no car audio is installed, an add-on speaker will be required. For the installation of the optional charging cradle, you will require a model-specific mounting that may be purchased from a specialist dealer

6.1.2 Telephone

A Bluetooth®-compatible telephone must be available for use with this system. You can find a list of supported Bluetooth® telephones online at www.fwd-online.de.

6.1.3 Muting (radio muting)

The muting function (Radio Muting) ensures that the audio sound is turned off during telephone calls. The system supports the muting function. Your car`s audio documentation will show whether your car audio has a mute option. If your car audio is not equipped with a muting option, you can install the optionally available Stereo Mute Box to facilitate speaker muting.

6.1.4 Upgrading existing Funkwerk hands-free installations to EGO TALK

The adapter cable is the ideal and simple solution for customers who already own a Funkwerk hands-free system (e.g. Audio 2000, 3000, Audio blue, Audio com, Audio compact) and would like to upgrade to EGO TALK. The adapter cable connects the ISO cable of your existing Funkwerk hands-free system to the EGO TALK.



NOTE! This simple upgrade is only possible for installations without a Stereo Mute Box. When installing your EGO TALK with a Stereo Mute Box, the ISO cable from the Stereo Mute Box is to be used for the connection to the car`s electrical system.

6.1.5 Add-on speakers / Car audio telephone connection

The car's loudspeakers are transferred to the system by means of switch contacts. These are designed for a peak power handling of 35 W (Sinus). Loudspeaker power handling exceeding 35 W leads to premature wear on the switching contacts. For higher outputs, use the telephone connection of the car audio or a 5 W / 4-Ohm satellite speaker. This port is only designed for voice reproduction.

6.1.6 Car audio line-in input

A car audio with a line-in input option is required for music reproduction in stereo. As an alternative to line-in, the car audio may have a mini-ISO port (block connector C), a 0.14 in jack socket or a RCA input socket. An appropriate adapter lead is required for the connection between the EGO TALK line-out and the line-in version of your audio system. If your car audio system has no line-in option, you can employ the optionally available Stereo Mute Box for stereo reproduction in combination with your car's front speakers.

6.2 Installation locations



RISK OF INJURY! Unsuitable installation locations may become a source of injury in an accident (or emergency braking) situation, or may inhibit the correct functioning of essential safety equipment.

6.2.1 Checking cable lengths

Before you've securely installed the components, check that the installation locations have been selected in such a way that the cable length is sufficient to connect the individual components.

6.2.2 Selection of the installation location for the electronics box

The Bluetooth® antenna for the connection to the mobile phone is installed in the electronics box. The antenna transmits directionally towards the front. For this reason,

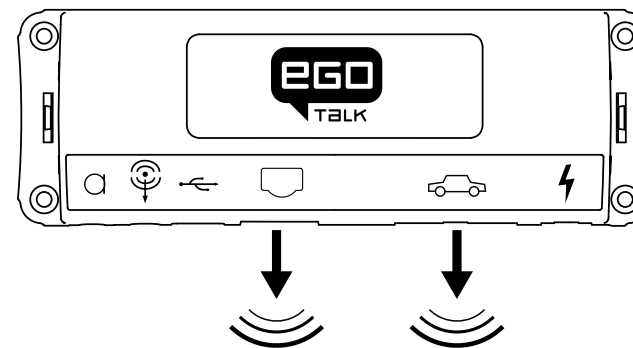

Fig. 02:
Signal transmission of
the Bluetooth® antenna

during installation, ensure that the antenna faces into the passenger cell (see Fig. 02). Vertical mounting is ideal. Metallic screening between the front panel and the passenger cell, such as metal or metallised plastic panels, are unsuitable and may interfere with the Bluetooth® connection. Locations behind the dashboard or in a metal-lined glove compartment are also unsuitable.

A covering in plastic, fabric or wood presents no problems whatsoever.

Suitable locations for the electronics box:

Passenger side, next to the middle console under the paneling, model-specific installation console (dealer).

Our suggested installation locations are shown in the illustration on the right.

Further unsuitable locations are:

Leg and knee height, potential head impact zone, airbag inflation space, engine compartment

6.2.3 Selection of the point of installation for the microphone

Suitable for the microphone:

Where voice can reach the microphone unhindered (distance between the speaker and the microphone should be approx. 13.78 in), on the A-column (between windshield and driver's side window), next to the driver's sun visor, on the dashboard

Unsuitable for the microphone:

Close to the speakers (less than 31 in), under the dashboard, in the air stream from open windows or air vents.

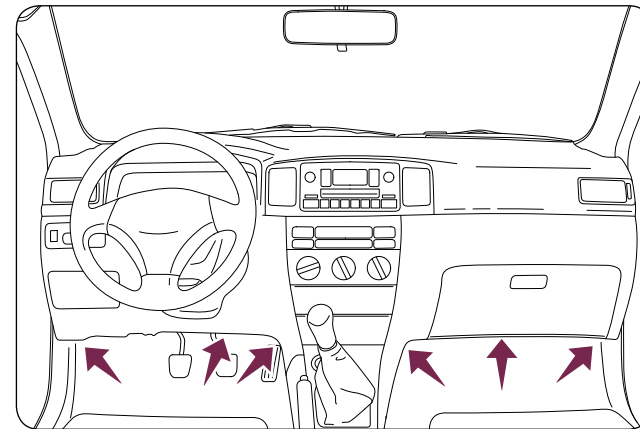

Fig. 03:
Installation locations
for the electronics box

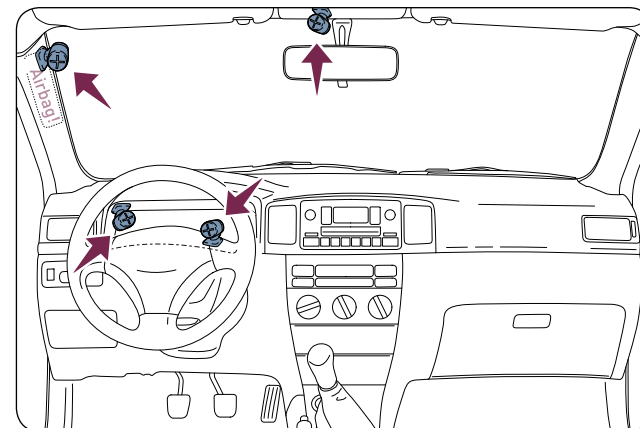

Fig. 04:
Installation location
for microphone

The illustration shows one of the potential microphone mounting locations. Alternatively, the microphone may be attached to the sun visor with the clip provided.

6.2.4 Selection of the installation location for the control console

Suitable for the control console:

In the space above the DIN installation shaft, close to the steering wheel (in an easily accessible and visible position)

Unsuitable for the control console:

Airbag inflation space, potential head impact zones, out of reach of driver's reach

6.3 Installation



DAMAGE TO ESSENTIAL VEHICLE COMPONENTS! – Essential vehicle components or wiring can be damaged when drilling mounting holes or screwing in self-threading screws. Please make sure there is always sufficient space behind the screw holes and drilled holes!

6.3.1 Mounting the electronics box

Installation consoles for a number of car models are available from your dealer. These are designed to contain all the system components, including the electronics box. When it is not possible to use an installation console, please proceed as follows:

Define the mounting points

Making sure that there is at least 2.8 in space for the plug and socket connectors.

Mark the positions for the fixing screws.

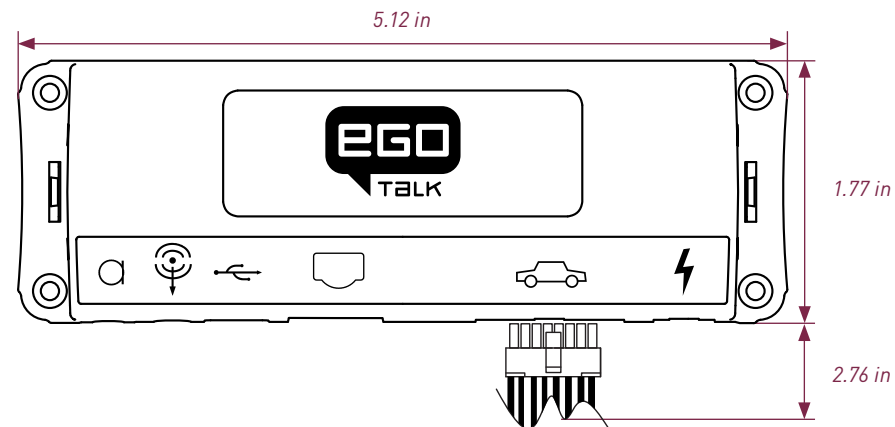

Fig. 05:
Electronics box
dimensions

Mounting the electronics box

For mounting the electronics box, use four self-threading screws and appropriate washers. We recommend size "ST 2,9x25 DIN 7981" self-threading screws. These are ideal for the fixing of the electronics box. Pre-drill the holes with a 0.08 in drill.

6.3.2 Mounting the microphone

Define the mounting location

The microphone holder has a self-adhesive strip on the back. The mounting location should have the same form and area as the self-adhesive strip on the microphone holder. The location selected must allow the microphone cable to reach the electronics box! Position the microphone with the head facing towards the direction of speech.

Cleaning and degreasing the mounting location

The mounting location must be clean and free from grease and dirt/dust. Prior to installation, clean the area with a cleansing product containing ethyl alcohol. Only use products that do not damage plastics or varnished wood finishes and are themselves free of oils or grease. Unsuitable cleansers are, for example, lighter fluid, acetone, turpentine, trichloroethylene and similar products.

Attaching the microphone holder

Peel off the protective backing from the self-adhesive strip. Hold the microphone holder at a distance of several millimetres (about a quarter of an inch) above the desired mounting location. Re-check the positioning. Re-positioning after mounting is no longer possible. Place the microphone holder on the mounting location and fix by applying short and light pressure.

Attaching the microphone

Attach the microphone by sliding it into the holder and position the microphone head towards the direction of speech.

6.3.3 Mounting the control console

Define the mounting location

The control console is mounted on a smooth surface by means of the self-adhesive pad provided. Make sure that the location is within easy reach of the intended user.

Cleaning and degreasing the mounting location

The mounting location must be clean and free from grease and dirt/dust. Prior to installation, clean the area with a cleansing product containing ethyl alcohol. Only use cleansing products that do not damage plastics or varnished wood finishes and are themselves free of oils or grease. Unsuitable cleansers are, for example, lighter fluid, acetone, turpentine, trichloroethylene and similar products.

Attaching the control console

After defining the appropriate cable direction on the back of the console, fix it by covering it with the self-adhesive pad. Hold the control console at a distance of several millimetres (about a quarter of an inch) above the desired mounting location. Re-check the positioning. Re-positioning the console after mounting is no longer possible. Apply the control console to the proposed mounting location and fix by applying short and light pressure.

6.4 Connection scheme

Installation for call reception for a car audio system with a mute input but without a phone input

With this connection option, voice playback is emitted from the front right car speaker. During calls, the mute input blocks the car audio signal.



NOTE: Please observe the information in section “6.5.1 Checking the mute inputs” on connecting the mute lead of the ISO connecting cable.

Installation for voice playback with a car audio system with phone and mute input options

With this connection option, voice playback comes through the car audio system speakers. During calls, the car radio output is switched to the phone input by the mute input. In order to access the phone input of your car audio system, the speaker output of your EGO TALK must be connected to the phone input of your car audio system. The purple and green leads of the ISO cable must be connected to the car audio phone input for this option. The purple and green leads must be disconnected from the ISO connector. The green lead (pin 14 of the 14-pin plug) should be connected to „Phone Out“, and the purple lead (pin 7 of the 14-pin plug) to „Phone In +“ of the Mini-ISO socket.

For information on the phone connection options of your car audio system, please consult the manufacturer’s user manual.



NOTE: If your car audio system has different phone connection options from those mentioned here, please consult a qualified professional for installation of the system. Furthermore, please read the section with information on connecting the mute lead of the ISO connection cable, "6.5.1 Checking the mute input".

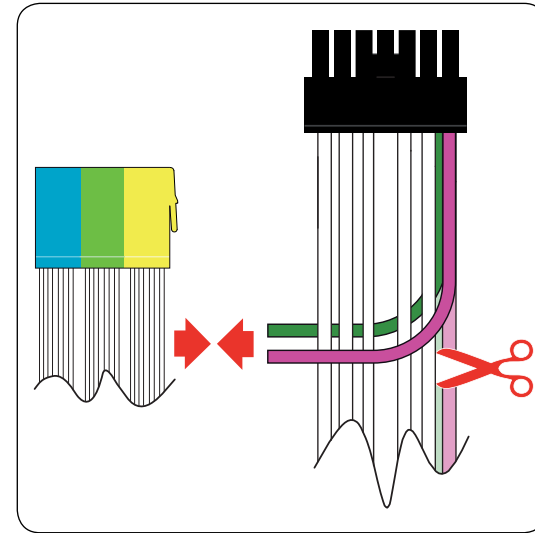
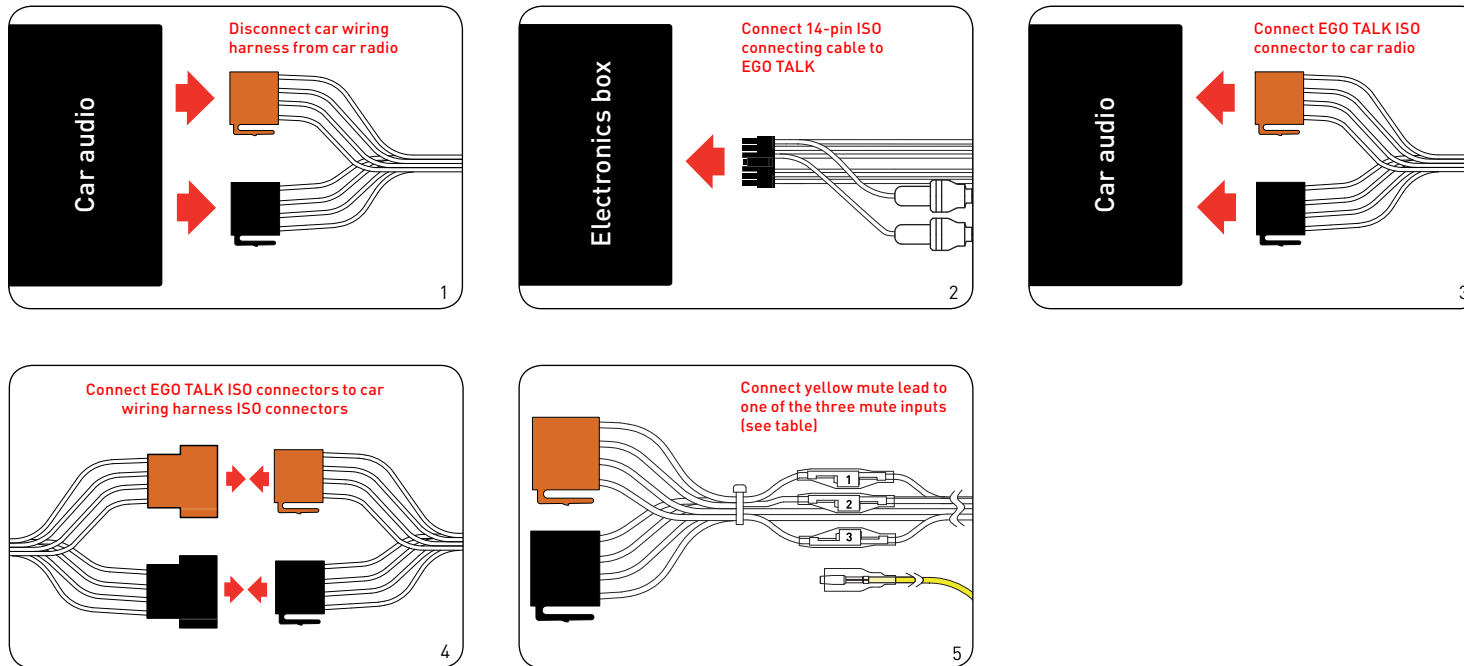

Fig. 06:
Mini-ISO
connection

6.5 Installation of the ISO connecting cable

The battery must be disconnected before starting cable installation. Disconnect the grounding cable from the negative pole of the battery. The cable installation procedure is shown in the illustrations.

Fig. 07:
Installation
procedure



When the installation is completed, reconnect the grounding cable to the negative pole of the battery.

6.5.1 Checking the mute inputs

Picture 5 of Fig. 07 shows mute inputs 1–3. The yellow mute lead of the hands-free system should be connected to one of these inputs. Which mute input should be selected is shown in the tables:

Fig. 08:
Type-
dependent
pin allocation

Socket contact housing			
Radio model	Pin	Wire colour	Function
Audi, Volkswagen, Grundig	1		
	2		Mute
	3		
	4	blue	Ignition (15)
	7	red	Permanent positive (30)
	8	brown	Ground (31)

Socket contact housing			
Radio model	Pin	Wire colour	Function
Ford, Mercedes, Porsche, Becker	1		
	2		
	3		Mute
	4	red	Permanent positive (30)
	7	blue	Ignition (15)
	8	brown	Ground (31)

Socket contact housing			
Radio model	Pin	Wire colour	Function
Blaupunkt	1		
	2		Mute
	3		
	4	red	Permanent positive (30)
	7	blue	Ignition (15)
	8	brown	Ground (31)

Socket contact housing			
Radio model	Pin	Wire colour	Function
Philips	1		Mute
	2		
	3		
	4	red	Permanent positive (30)
	7	blue	Ignition (15)
	8	brown	Ground (31)

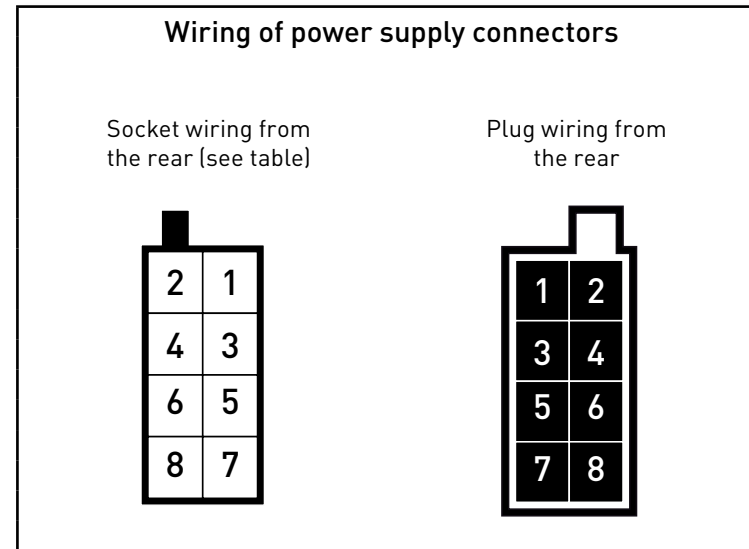

Fig. 09:
Plug wiring scheme

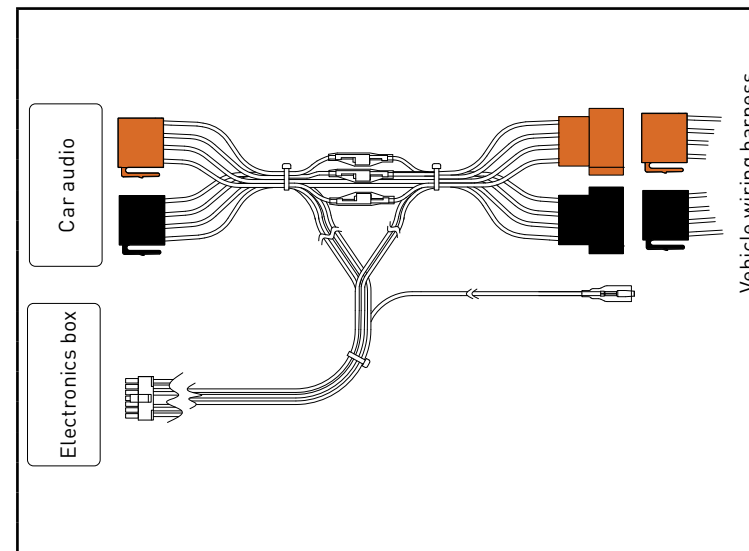

Fig. 10:
Connection system

6.5.2 Checking the installation

When the ISO connection cable is correctly installed, a call remains active until the call is ended, even if the ignition has already been turned off beforehand. The system switches off automatically when the call has been ended. If the system switches to off immediately switches off, then exchange the ignition lead (blue) with the power supply lead (red) as shown in Fig. 11b

Abb. 11a:
View of original
connection



Abb. 11b:
View after
changing cables



PLEASE NOTE: the fuses should remain in place when opening the fuse compartment, make sure that they are not inadvertently exchanged!

6.5.3 Additional external speakers

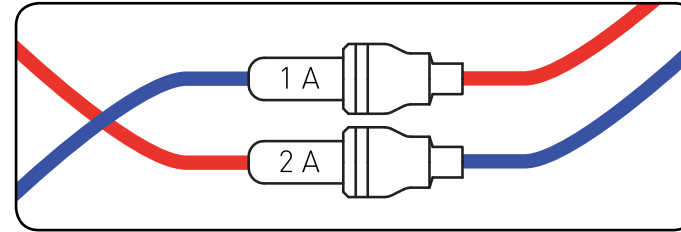
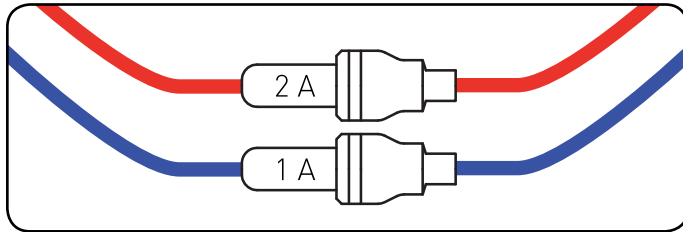
In the following cases, additional speakers (4 Ω , min. 5 W) must be used:

- when the car audio system speakers should not be used
- when the output rating of the speaker channel is greater than 35 W (Sinus) and the car audio system has no phone connection option
- when the car audio system is used with active speakers and has no phone connection option

Feedback interferes with the clarity of calls. Mount additional speakers at a distance of at least 31 in from the microphone. When mounting additional speakers, please observe the manufacturer's installation instructions. Speakers can be connected to the green (pin 14) and the purple (pin 7) leads of the connection cable. First of all, the purple and green leads must be disconnected from the ISO connector (see Fig. 12).

Pin	Colour	Function
1	Brown	Ground (31)
2	Yellow	Radio mute
3		
4		
5		
6	White	Car audio speaker output + (front right)
7	Purple	Speaker lead + (front right)
8	Red	Permanent positive (30)
9	Blue	Ignition (15)
10		
11		
12		
13	Black	Car audio speaker output - (front right)
14	Green	Speaker lead - (front right)

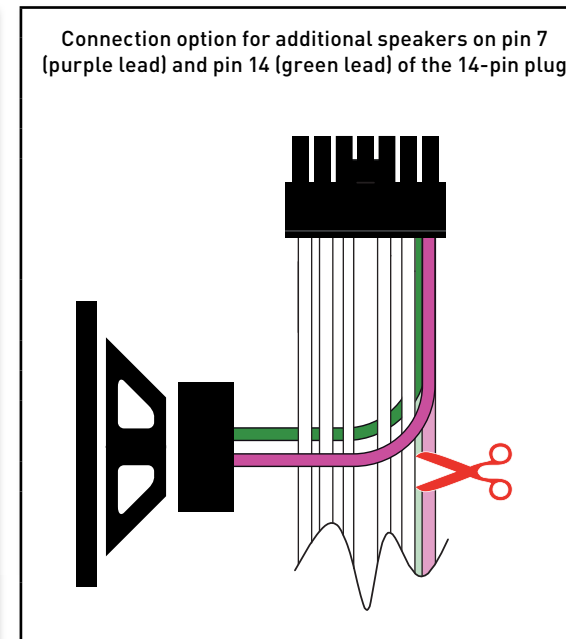
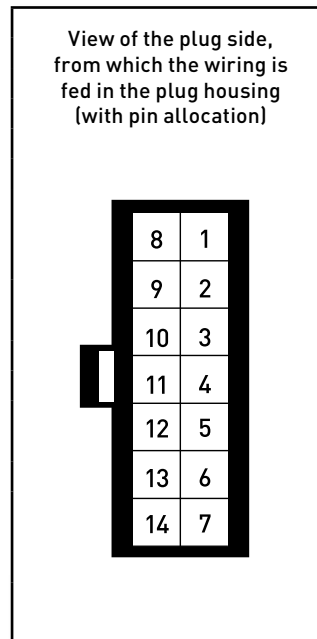

Fig. 12:
Additional external
loudspeakers

6.6 Connecting the components to the electronics box

The individual components are connected to the electronics box as follows:

- [1] Plug the microphone jack into the jack socket with the microphone symbol
- [2] The electronics box line-out must be connected to the car audio line-in. Depending on the car audio line-in configuration, one of the following cables is required:
 - Connection cable 0.14 in stereo jack to 0.14 in stereo jack (l = 4.92 ft)
 - Connection cable 0.14 in stereo jack to RCA plug (l = 4.92 ft)
 - Connection cable 0.14 in stereo jack to Mini-ISO (l = 4.92 ft)
- [3] The control console must be connected to the control console input.

- [4] The 14-pin plug of the ISO connecting cable must be connected with the electronics box.
- [5] The base plate for the charging cradle may also be connected to the “charger” output socket.
- [6] The USB port is exclusively reserved for servicing purposes.

Fig. 13:
Electronics box
connection

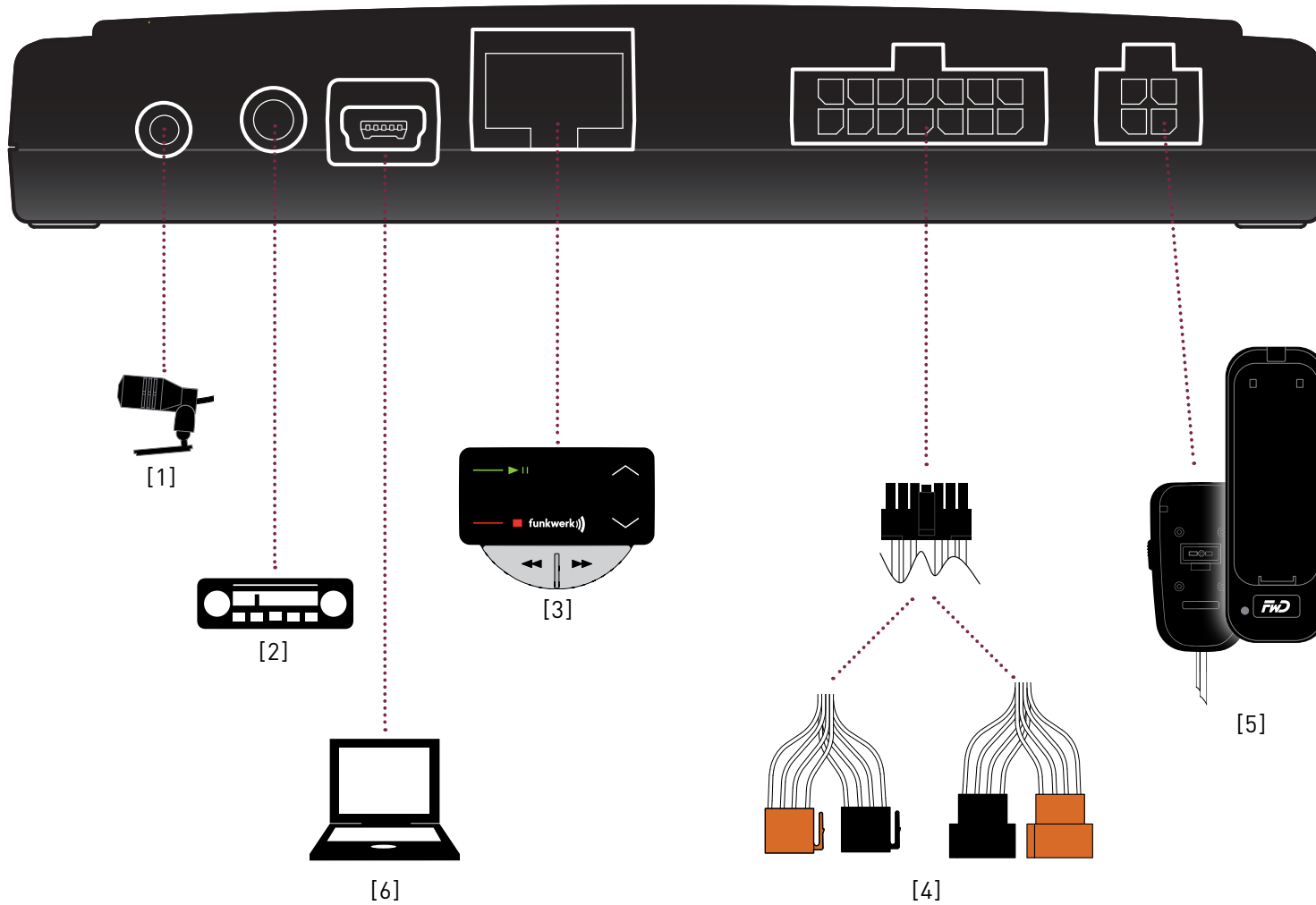

6.7 Operational test

An operational test is only possible after coupling the system with a Bluetooth®- compatible device. The procedure is explained in the sections “7.3 Getting started” and “7.5 Audio Player” shown in the following pages.

7 User Guide

-  **ROAD SAFETY RISK!** Distracted attention can lead to dangerous situations in traffic. Even when using hands-free phone systems, your complete attention must be paid to the current traffic conditions. It is always advisable to avoid phone calls while driving in difficult traffic situations!

7.1 Features

7.1.1 Overview of features

The hands-free EGO TALK system supports the Bluetooth® Hands-free Profile. This means that you can operate phones that support this profile with our system. EGO TALK is the intelligent entry-level solution for in-car telephony and offers the following range of features:

- Call functions, such as incoming/outgoing calls and redial
- Supports mobile voice dialing
- Music playback – playback of music files from mobile phones, iPods™ or MP3 Players via Bluetooth® Audio-Streaming (A2DP)
- Automatic radio muting
- Registration of up to 8 mobile phones

7.2 Symbols

The control console of the EGO TALK has a total of six keys. The illustration on the right shows an overview of the key locations. The functions of the existing keys are explained in the following section.

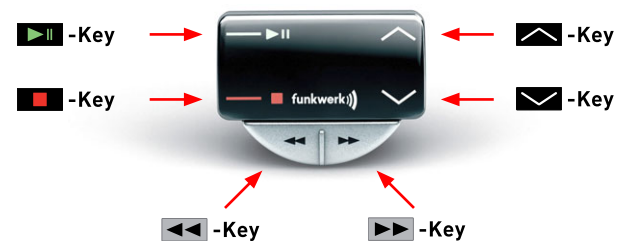

Key functions



→ The  key (green) is for accepting calls. It also controls the redial function; if you have already dialed a number from your phone, press this key to redial. When listening to music, this key controls both the play and pause functions.

Functions: accept, redial, play, pause



→ The  key (red) is used for rejecting incoming calls and ending completed calls (hang-up). During music playback, this key controls the track stop function. This key is also the switching control between hands-free mode and music control mode.

Functions: hang-up, reject, stop, switch between hands-free and music control



→ The  key starts the phone's voice dialing function. It supports the features shown in the user's manual of your mobile phone model. During music playback, the key performs the forward-skip function. Only complete titles can be skipped.

Functions: start phone voice dialing function, forward skip



→ The  key controls the reverse-skip function.

Functions: reverse skip



→ The  key increases the volume in phone and music playback modes.

Functions: raise volume



→ The  key decreases the volume in phone and music playback modes.

Functions: lower volume

LED indicators

Two different coloured LEDs (red and green) are integrated in the EGO TALK. The LEDs indicate the current status of the system. The following combinations are possible.

LED Status

- Green blinks at intervals → no device coupled
- Both red and green steadily on → Hands-free connection enabled (hands-free mode)
- Green only on → A2DP active (music mode)
- Green steadily on and red momentarily off → Music playback stopped (Both profiles enabled, hands-free mode)
- Red steadily on and green blinks periodically → active call

7.3 Getting started

Take enough time to familiarize yourself with the use of the system in combination with your phone. First of all, make a few calls to determine the ideal volume and the best voice pick-up direction before using the system in traffic. The best way of optimizing conditions of use is to park your car in a quiet place especially for this purpose. It is also helpful if another phone user can take some time to assist you when making test calls.

7.3.1 About Bluetooth® technology

Bluetooth® technology is a wireless technology and allows, as such, communication between individual devices without the need for cables. Data and voice information can be transmitted simultaneously. It is not unnecessary to have line-of-sight routing between the devices. The transmission/reception range in the open is typically 32.8 feet. Interference from other electrical or electronic equipment or obstacles may, however, reduce this range. The frequency band in which Bluetooth® operates, is reserved virtually worldwide. This coupled with the fact that each Bluetooth® product is tested and approved for compatibility with other Bluetooth devices, ensures the highest possible levels of compatibility with devices from a wide range of manufacturers. The EGO TALK supports the Bluetooth® Hands-free Profile. This means that it is fully compatible with all phones supporting the Bluetooth® Hands-free Profile. If uncertain, read the User Guide of your mobile phone to see which profiles are supported.

A2DP (Advanced Audio Distribution Profile) is a technology that enables the wireless transmission of stereo audio signals via Bluetooth® to a compatible receiving device. Please take a look at our homepage for information about compatible mobile phones.

7.3.2 On / Off function

Turning the ignition key simultaneously activates the hands-free system. Immediately after the system is activated, the two LEDs blink four times. This indicates that the system is in standby mode and ready to make a connection. In order to use the system for phone calls, a Bluetooth® compatible phone must be coupled to the EGO TALK system. How this is done is explained in detail in the following sections. When the ignition is turned off, the hands-free system also shuts down. If the ignition is turned off during a call, the phone's capabilities are maintained and the system only shuts down when the call has been completed.

7.3.3 Coupling



A mobile phone intended for use with the hands-free system must be coupled to the EGO TALK. As long as no devices are connected, the system is visible for all Bluetooth® devices. In this state, the green LED blinks every 7.5 seconds to indicate that no devices are connected. The telephone to be used must be registered with the EGO TALK. The Bluetooth® search and coupling procedure is initiated from the telephone. The Bluetooth® code is "EGO TALK". The default input PIN is "0000". When the connection/coupling procedure is successfully completed, both diodes are steadily on. One phone per user may be coupled. If you wish to couple an additional phone, use your initial phone to decouple the current connection. Should you encounter problems while coupling, please read the section "Solving Problems", and take a look in your phone manual at the section about Bluetooth® operations.

7.3.4 Automatic coupling



If a phone is already connected with the system, the EGO TALK tries to couple to this phone. When a connection has been successfully made, the two LEDs are steadily on. The connection is always made to the most recently coupled phone. If this phone is out of range, the system will search for other phones registered in the system. When the search is successful, the connection to this phone is completed automatically. If the search process was unsuccessful, the system reverts to the coupling mode. This enables manual connection from the phone.

7.4 Calling

7.4.1 Incoming call

When an incoming call is received, the ring tone is audible over the EGO TALK. At the same time, the green LED blinks periodically. Pressing key  accepts the incoming call. If the call is to be rejected, press the  key. When the system registers an incoming call during audio playback, the system automatically switches to hands-free mode. After completion of the call, you can revert to audio playback mode by pressing key  to restart the player.

7.4.2 Outgoing call

There are various options for initiating a call. Pressing the key  starts the phone's redial function and dials the last number called. When the connection has been made, the green LED blinks periodically. Pressing the  key initiates the phone's voice dialing mode. You can now verbally give the number, name or commands supported by your phone. The green LED also blinks periodically in this mode when the call has successfully been placed. The third option is direct dialling from the mobile handset.



IMPORTANT NOTE: Please observe your country's regulations on in-car telephone use!



7.5 Audio Player

7.5.1 Coupling



Coupling with music players varies from model to model. If you are using a phone that supports both hands-free and A2DP, there is no need to repeat the coupling procedure, because the phone is already coupled to the system. However, when using a player that does not support A2DP (MP3 Player), this must be equipped with a separate A2DP adapter. In the case of such players, there may be no connection between the EGO TALK and your phone when coupling for the first time, otherwise the stand-alone device will be unable to find the EGO TALK unit. In this case, the connection to the phone must be disabled. Once the device has been recognised, a direct connection will be made to your EGO TALK, even when

a phone connection already exists. A2DP compatible phone models differ in the method of starting music players. You can find more information on this subject on our homepage.

7.5.2 Play / Pause

When an A2DP player is connected and the player has been started, the  key starts music playback. Playback can be temporarily stopped by the  key (pause function) and resumed by repressing the same key (resume function).

7.5.3 Stop

Playback can be stopped when listening to music by pressing the  key. The  key can also be used to stop music playback and switch to hands-free mode.

7.5.4 Skip function

If you wish to skip forward one track, press the  key. To skip back one track press the  key.

7.6 Volume

The volume of audio playback can be controlled by the  and  keys. Pressing the  key raises the volume, pressing the  key lowers the volume.

8 Service

FAQ – List of frequently asked questions:

- 1. How big are the displays and/or control consoles?**
You can find the dimensions in the “Technical specifications”.
- 2. Are EGO systems suitable for all car models?**
Yes, EGO systems are suitable for all cars. See the installation guide!
- 3. Is there a list of optional charger cradles?**
Yes. You can find a list of the available holders on our homepage.
- 4. Where can I buy EGO systems?**
Through an authorized dealers. You can locate the nearest authorized dealer online, just click on Dealer → Dealer Search.
- 5. How are files exported for music playback?**
EGO TALK can play music files over A2DP. But if your MP3 player doesn't have A2DP, you will need an A2DP adapter. You can make your MP3 player or iPod™ Bluetooth® compatible with a dongle/adapter.
- 6. Do EGO systems have an external antenna option?**
Your mobile phone can be connected to an external antenna in conjunction with our charging cradle, available as an optional accessory.

Troubleshooting:

Problem	Ursache	Abhilfe
EGO TALK doesn't turn on	Power supply disabled	If necessary, replace fuse and check all leads and connections
	Ignition not on	Turn ignition on
	Ignitions circuit disabled	Check cable and 1 A fuse
The party you are calling cannot hear you	Microphone not plugged in	Connect microphone to electronics box, defective cables require replacement
The party you are calling complains about interference	Microphone in air stream	Mount microphone elsewhere or reduce ventilation
	Phone too close to EGO TALK components or car radio	Increase the distance between your phone and the EGO Talk or radio
The party you are calling hears an echo	Distance between microphone and speakers too small	Increase distance or lower volume
	Volume too high	Lower volume
Your phone cannot find EGO TALK during coupling	EGO TALK already connected to another device	Disconnect existing connection
Sound is unclear, distorted	Poor Bluetooth® connection	Reduce the distance between your phone and the EGO TALK or remove any (metallic) obstructions
No connection to coupled phone when ignition turned on	Phone is out of range.	Make sure your phone is within the range of the EGO TALK.
	Phone Bluetooth® interface is deactivated.	Switch phone Bluetooth® function to "ON" (Option "Automatic" is not sufficient)
	Phone requires confirmation of connection set-up.	Confirm connection on your phone. Deactivate security function (see your phone manual)
	One of the two devices no longer has a valid connection code.	Repeat the coupling procedure.

9 Spares parts and accessories

You can find out more about supported mobile phones on our website at www.fwd-online.de. Your dealer will also be happy to advise you if you have any questions.

Accessories:

Stereo Mute Box

Relax and listen to music or phone from your car. The Stereo Mute Box provides smart sound management. This compact box plays your calls or music over the car's speakers – of course in superb stereo sound. The car radio is muted during calls or when listening to music.

Features:

- Radio muting during calls or music playback (Audio Streaming)
- Stereo music reproduction in combination with the car's front speakers
- Phone audio over the front speakers



Base plate with charging cradle

The charging cradle is a practical accessory for Bluetooth® hands-free systems by Funkwerk Dabendorf. The charging cradle holds your mobile phone firmly and allows you to recharge its batteries in your car and is an ideal accessory for drivers who are constantly on the road and often need their phones. In addition, the external antenna connection ensures outstanding reception and transmission.

Features:

- Intelligent charging circuit for mobile phones
- Mobile phone safely and securely held in the charging cradle
- External antenna connection for excellent call quality



Replacement parts:

- [1] Electronics box
- [2] Control console
- [3] Microphone
- [4] Cable connection set
- [5] Adapter cable

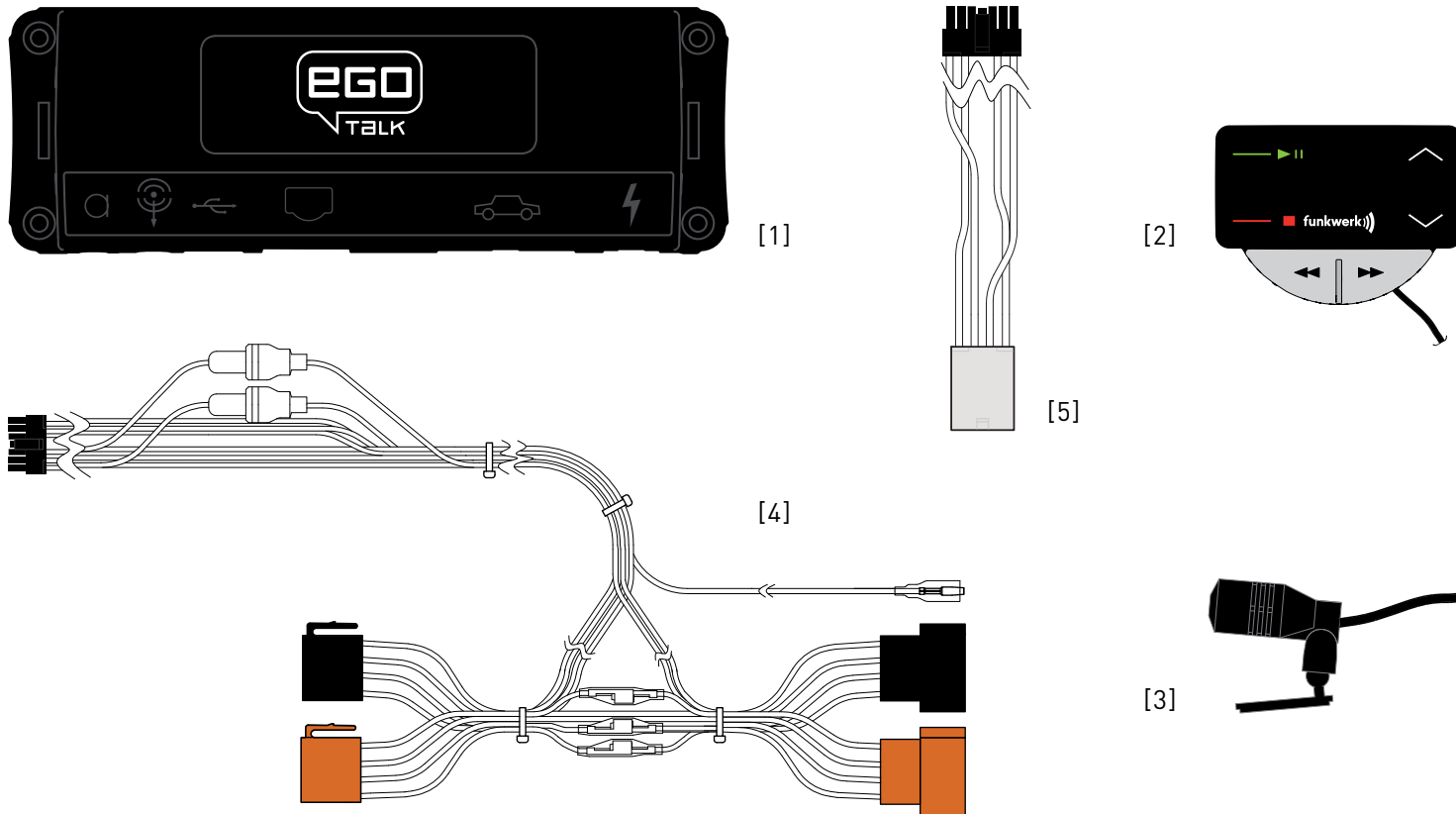

10 Technical specifications

External dimensions: Electronics box	5.1 in x 1.8 in x 0.9 in
External dimensions: Control console	1.8 in x 1.3 in x 0.7 in
Cable length: Control console	6.6 ft
Operating voltage	11 V to 15 V
Quiescent current (ignition off)	max. 0,1 mA
Fuse: Permanent positive	2 A
Fuse: Ignition	1 A
Temperature range	14 °F to 131°F
Supported Bluetooth® Profiles	Handsfree, A2DP, AVRCP

11 Certification

CE 0681

Fully compliant with the EU R&TTE Directive 1999/5/EC



03 5010

Model certification according to EU Directive 72/245/EWG (2006/28/EC) "Electromagnetic compatibility in motor vehicles"



Bluetooth® is a registered brand name of Bluetooth SIG, Inc.

12 Conformity statement

This equipment employs Bluetooth® wireless technology. In some countries, the use of this equipment may be restricted or forbidden. Please make sure you are familiar with such restrictions and do not use your equipment if you are unsure whether its use is permitted in particular countries you may be visiting.

Bluetooth® is a registered brand name of Bluetooth SIG, Inc.

Funkwerk Dabendorf GmbH
Märkische Straße
D-15806 Dabendorf

Confirms that the **hands-free system “EGO TALK”** complies with the fundamental requirements and other relevant regulations of the EU Directive 1999/5/EC.

CE 0681

FCC statements

This device complies with part 15 of the FCC Rules. Operation is subject to the following two conditions: (1) This device may not cause harmful interference, and (2) this device must accept any interference received, including interference that may cause undesired operation.



NOTE: This equipment has been tested and found to comply with the limits for a Class B digital device, pursuant to Part 15 of the FCC Rules. These limits are designed to provide reasonable protection against harmful interference in a residential installation. This equipment generates, uses and can radiate radio frequency energy and, if not installed and used in accordance with the instructions, may cause harmful interference to radio communications. However, there is no guarantee that interference will not occur in a particular installation. If this equipment does cause harmful interference to radio or television reception, which can be determined by turning the equipment off and on, the user is encouraged to try to correct the interference by one or more of the following measures:

- Reorient or relocate the receiving antenna.
- Increase the separation between the equipment and receiver.
- Connect the equipment into an outlet on a circuit different from that to which the receiver is connected.
- Consult the dealer or an experienced radio/TV technician for help.



WARNING: Changes or modifications made to this equipment not expressly approved by FWD may void the FCC authorization to operate this equipment.

FCC Radiation Exposure statement:

This equipment complies with FCC radiation exposure limits set forth for an uncontrolled environment. End users must follow the specific operating instructions for satisfying RF exposure compliance.

This transmitter must not be co-located or operating in conjunction with any other antenna or transmitter.

13 Hotline

Any questions, comments, or suggestions? Would you like some more detailed information? Do you need an adviser or service in your area? Just give us a call!

Our service hotline is there to help you during the following times:

Monday–Friday from 8.00 a.m. to 5.00 p.m. (PST)

Before you call us with your problem, please check first with the following steps:

- Check whether you can solve your problem with the „Troubleshooting“ checklist in Chapter 8.
- Make sure you have your hands-free system and holder set type available.
- Try to explain your problem as precisely as possible.

You can contact our service hotline by dialing:

Phone: (+1) 858.566.2170

Fax: (+1) 858.566.2179

eMail support@egohandsfree.com

RAYTEL Corporation

A partner of Funkwerk Dabendorf GmbH

8820 Kenamar Drive, Ste 506

San Diego, CA 92121

Telephone (+1) 858.566.2159

Fax (+1) 858.566.2179

eMail support@egohandsfree.com

Internet www.egohandsfree.com



A Funkwerk AG company.

Funkwerk Dabendorf reserves the right to modifications in the course of technological progress and deviations from the delivery scope! All rights reserved! Reproduction, in whole or in part, is only permitted with the prior written consent of Funkwerk Dabendorf GmbH!