



The A4-M1AM-E8C kit has an aluminium die-cast vandal resistant panel with colour CCD Camera, wall mountable with hood. The Slim Indoor Phone is 29.4mm in depth with a 7" colour Touch Screen display.

The kit is designed for fast installation: plug and play

Key Features: 7" colour Touch Screen display, 4-wire connection, hands free talking, door releasing and video monitoring, multiple configurations (1-1/2-5), wall mounting installation, Built in LED for light compensation at night, waterproof and dustproof design, plug pack included, dry contact for lock output

Specifications:

Monitor

Model	A4-E8C
Power Supply	DC 13.5V/1A
Wiring	4-wire, polarity connection
Display	7" colour Touch Screen
Ring Tone	9 Ring Tones choices
Talk	Hands free
Cable Length	≤50m-AWG20;≤100m—AWG18
Ambient Temp.	-10°C ~ 40°C
Installation	Surface Mount
Dimensions	223 x 138 x 29.4mm

Door station

Model	A4-M1AM
Camera	1/3" Colour CCD
Minimum Illumination	1.0 Lux
Visual Angle	90° Wide Angle
Wiring	4-wire, polarity connected
Cable Condition	50m/165ftRVV22#4x0.65mm
Ambient Temp.	-10°C ~ 40°C
Weight	0.5kg
Dimensions	112.3 x 171.8 x 36.6mm

■ OVERVIEW

Front



1. Screen

2. Speaker

3. Monitor Key 1

4. Monitor Key 2

5. Open Key

6. Talk Key

7. Ring tone Key

8. Microphone

Back

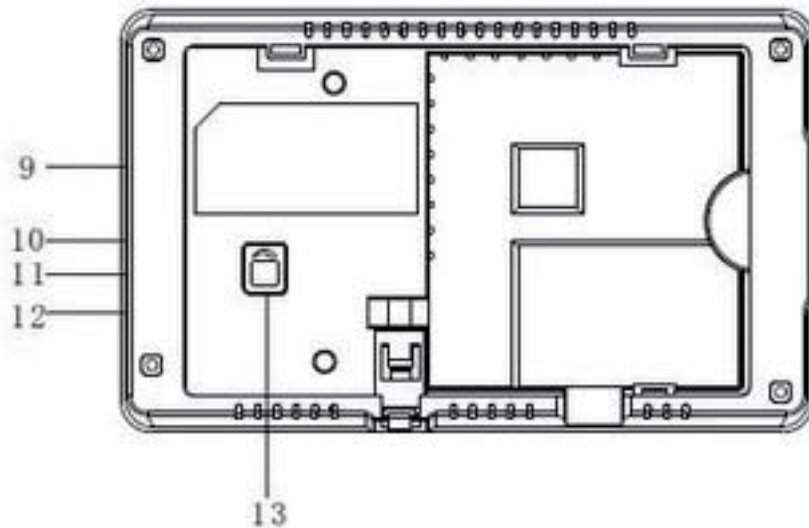

9. Talk Volume Control Knob

10. MENU Key

11. ▲ UP Key

12. ▼ DOWN Key

13. Ringing Volume Control Potentiometer

■ APPEARANCE

FRONT VIEW

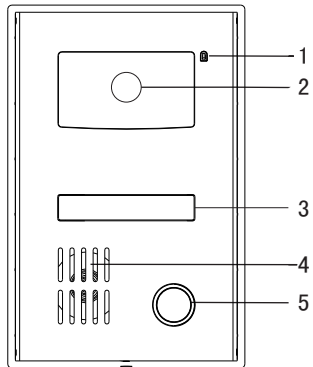

BACK VIEW

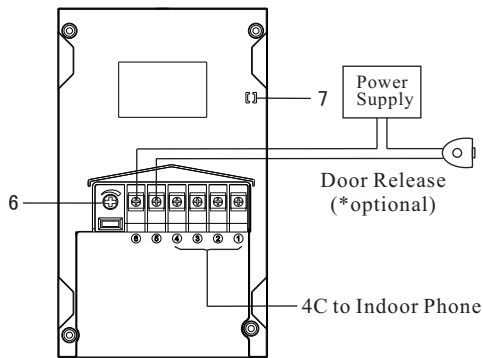

1. Mic

Highly sensitive condensed microphone.

2. Camera

3. Doorplate

4. Speaker

Provides a high quality audio for the visitor.

5. Call Button

Call the resident/tenant

6. Volume Control

When squeak occurs, you may turn “VOL” to adjust the volume to solve the problem.

7. Anti-tamper Switch

In case the device is tampered, the Outdoor Camera will call the Indoor Phone automatically to alert the resident.

■ INSTALLATION

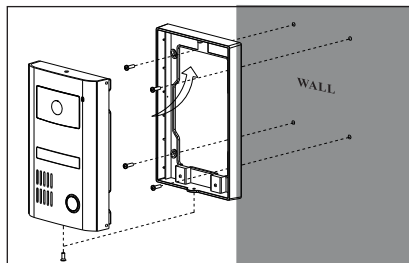
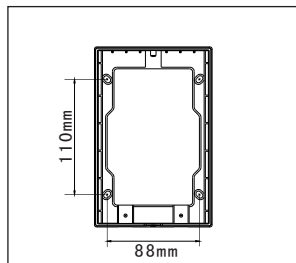

I. VIEW RANGE

Side View

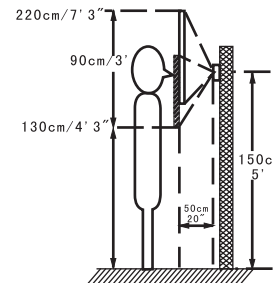

Front View

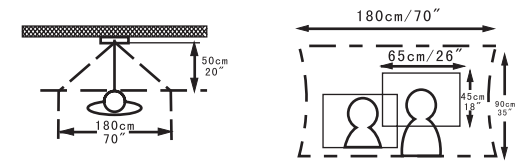

Notes: a. All the figures above are just for reference, which may vary according to the surroundings.

b. Please adopt the cable recommended by the supplier. Do not use UTP cable.

II. INSTALLATION CONDITIONS

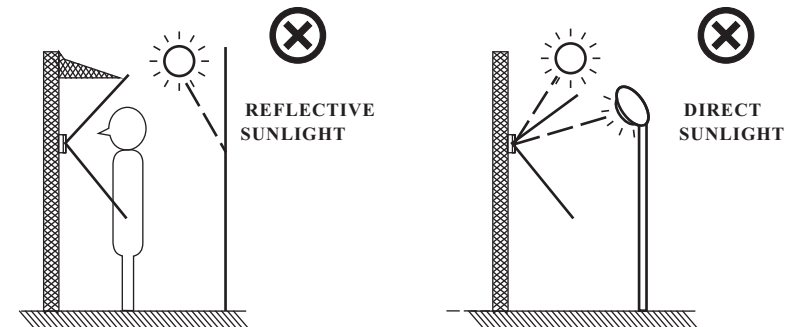

1. Avoid installing the device in the following conditions: freezing, high temperatures (>70°C), chemical corrosion, etc.

2. Do not install it in the place where it may be exposed to direct or reflective sunlight.

3. Do not install it in the location easily subject to rain or moisture.



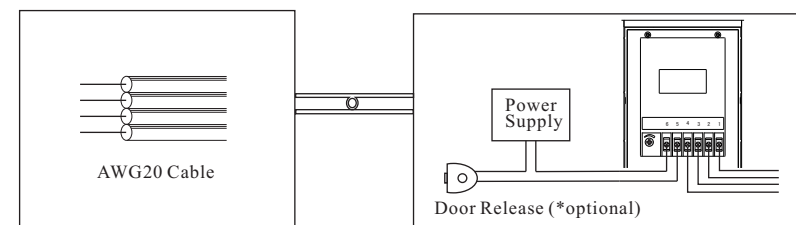

■ WIRING

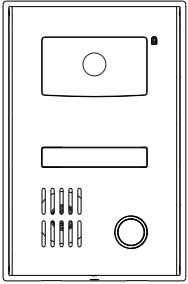

■ TECHNICAL SPECIFICATIONS

Model	A4-M1AM
Camera	1/3" Colour CCD
Minimum Illumination	1.0 Lux
Visual Angle	90°Wide Angle
Wiring	4-wire, polarity connected
Cable Condition	50m/165ftRVV22#4x0.65mm
Ambient Temp.	-10°C ~ 40°C
Weight	0.5kg
Dimensions	112.3 x 171.8 x 36.6mm

■ PARTS CHECKLIST

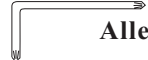
 <p>OUTDOOR CAMERA 1</p>		User Manual	1
		Mounting Bracket	1
		Screw (M4×30mm)	4
		Plastic Wall Plug	4
		Allen Key	1



