

## Technical Specifications

Power	AC 120V~60Hz	AC 230/240/250V~50/60Hz
Fuse	20mm Glass T6.3A Fast Blow	20mm Glass T5A Fast Blow
Lamp	HID 150W	
Dimension	695 x 340 x 250 mm (IR-5S/5B-HID) 360 x 340 x 250 mm (IR-4C-HID) 685 x 380 x 200 mm (IS-6S/6B-HID) 375 x 380 x 200 mm (IS-4-HID)	
Weight	10.6 kg (IR-5S/5B-HID) 8 kg (IR-4C-HID) 9.4 kg (IS-6S/6B-HID) 7.5 kg (IS-4-HID)	

**Innovation, Quality, Performance**

# iSolution

Your integrated Solution

**DMX512**

**LINKABLE**  
  
**STAND ALONE**



Marvelous  
Sound  
Activation



*Shaking*



iRock-5S-HID



iRock-5B-HID



iRock-4C-HID



iShow-6S-HID



iShow-6B-HID



iShow-4-HID

# User Guide

---

Professional Entertainment Technology

## 7. Fixture Cleaning

The cleaning of internal and external optical lenses and/or mirrors must be carried out periodically to optimize light output. Cleaning frequency depends on the environment in which the fixture operates: damp, smoky or particularly dirty surrounding can cause greater accumulation of dirt on the unit's optics.

- Clean with soft cloth using normal glass cleaning fluid.
- Always dry the parts carefully.
- Clean the external optics at least every 20 days. Clean the internal optics at least every 30/60 days.

### **EC Declaration of Conformity**

We declare that our products (lighting equipments) comply with the following specification and bears CE mark in accordance with the provision of the Electromagnetic Compatibility (EMC) Directive 89/336/EEC.

EN55014-2: 1997 A1:2001, EN61000-4-2: 1995; EN61000-4-3:2002;  
EN61000-4-4: 1995; EN61000-4-5: 1995, EN61000-4-6:1996,  
EN61000-4-11: 1994.

&

### **Harmonized Standard**

EN60598-1: 2000+ALL:2000+A12:2002  
Safety of household and similar electrical appliances  
Part 1 : General requirements

2B

## TABLE OF CONTENTS

1. Safety Instruction
2. Technical Specification
  - 2.1 Inserting/Exchanging rotating gobos
  - 2.2 Beam Angle
3. Lamp
4. How To Set The Unit
  - 4.1 Control Panel
  - 4.2 Main Function
5. How To Control The Unit
  - 5.1 Master/Slave Built-In Preprogrammed Function
  - 5.2 Easy Controller
  - 5.3 ISolution Operation / Universal DMX Controller
  - 5.4 Universal DMX Controller
  - 5.5 DMX512 Configuration
  - 5.6 DMX512 Connection
6. Troubleshooting
7. Fixture Cleaning

## 1. Safety Instruction



### WARNING

Please read carefully the instruction, which includes important information about installation, operation and maintenance.

- ◆ Please keep this User Guide for future consultation. If you sell the unit to another user, be sure that they also receive this user guide.
- ◆ Unpack and check carefully there is no transportation damage before using the unit.
- ◆ Before operating, ensure that the voltage and frequency of power supply match the power requirements of the unit.
- ◆ It's important to ground the yellow/green conductor to earth in order to avoid electric shock.
- ◆ The unit is for indoor use only. Use only in a dry location.
- ◆ The unit must be installed in a location with adequate ventilation, at least 50cm from adjacent surfaces. Be sure that no ventilation slots are blocked.
- ◆ Disconnect main power before fuse/lamp replacement or servicing.
- ◆ Replace fuse/lamp only with the same type. Do not use any other type of lamp.
- ◆ Make sure there is no flammable materials close to the unit while operating as it is fire hazard.
- ◆ Use safety cable when fixes this unit. Don't handle the unit by taking its head only, but always by taking its base.
- ◆ Maximum ambient temperature is TA: 40°C. Don't operate it where the temperature is higher than this.
- ◆ Unit surface temperature may reach up to 85C. Don't touch the housing bare-hand during its operation. Turn off the power and allow about 15 minutes for the unit to cool down before replacing bulb or serving as the unit could be very hot.
- ◆ In the event of serious operating problem, stop using the unit immediately. Never try to repair the unit by yourself. Repairs carried out by unskilled people can lead to damage or malfunction. Please contact the nearest authorized technical assistance center. Always use the same type spare parts.
- ◆ Don't connect the device to any dimmer pack or power pack.
- ◆ Do not touch any wire during operation as high voltage might be causing electric shock.

## 6. Troubleshooting

Following are a few common problems that may occur during operation. Here are some suggestions for easy troubleshooting:

### A. The unit does not work, no light and the fan does not work

1. Check the connect power and main fuse.
2. Measure the mains voltage on the main connector.
3. Check the power on LED.

### B. Not responding to DMX controller

1. DMX LED should be on. If not, check DMX connectors, cables to see if link properly.
2. If the DMX LED is on and no response to the channel, check the address settings and DMX polarity.
3. If you have intermittent DMX signal problems, check the pins on connectors or on PCB of the unit or the previous one.
4. Try to use another DMX controller.
5. Check in the DMX cables run near or run alongside to high voltage cables that may cause damage or interference to DMX interface circuit.

3B

### C. Some units don't respond to the easy controller

1. You may have a break in the DMX cabling. Check the LED for the response of the master/ slave mode signal.
2. Wrong DMX address in the unit. Set the proper address.

### D. No response to the sound

1. Make sure the unit that does not receive DMX signal.
2. Check microphone to see if it is good by tapping the microphone

### E. One of the channels is not working well

1. The stepper motor might be damaged or the cable connected to the PCB is broken.
2. The motor's drive IC on the PCB might be out of condition.

### F. The lamp is cutting out intermittently

1. The lamp is not working well. Check the main voltage either too high or too low.
2. Internal temperature may be too high. Check and if necessary replace the fan on the head.

## 5.6 DMX512 Connection

The DMX512 is widely used in intelligent lighting control, with a maximum of 512 channels.

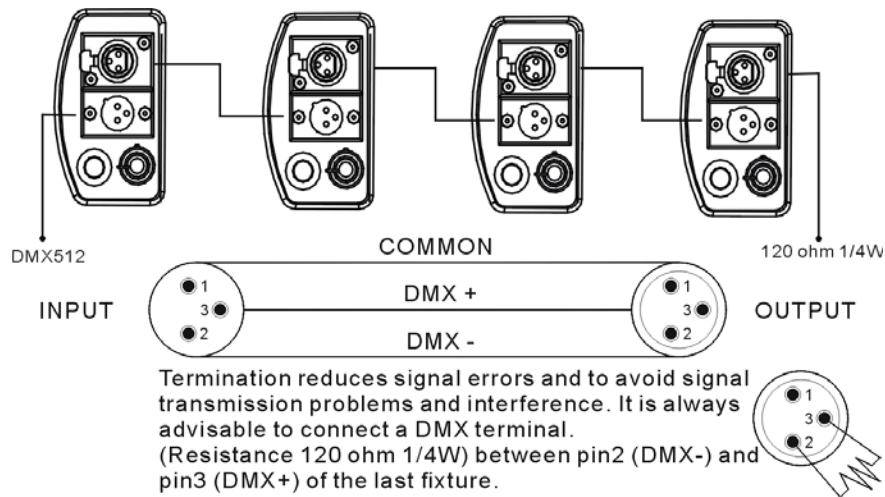

- 1.If you using a controller with 5 pins DMX output, you need to use a 5 to 3 pin adapter-cable.
- 2.At last unit, the DMX cable has to be terminated with a terminator. Solder a 120 ohm 1/4W resistor between pin 2(DMX-) and pin 3(DMX+) into a 3-pin XLR-plug and plug it in the DMX-output of the last unit.
- 3.Connect the unit together in a `daisy chain` by XLR plug from the output of the unit to the input of the next unit. The cable can not branched or split to a `Y` cable. DMX512 is a very high-speed signal. Inadequate or damaged cables, soldered joints or corroded connectors can easily distort the signal and shut down the system.
- 4.The DMX output and input connectors are pass-through to maintain the DMX circuit, when power is disconnected to the unit.
- 5.Each lighting unit needs to have an address set to receive the data sent by the controller. The address number is between 0-511 (usually 0 & 1 are equal to 1).
- 6.The end of the DMX512 system should be terminated to reduce signal errors.
- 7.3 pin XLR connectors are more popular than 5 pin XLR.
  - 3 pin XLR: Pin 1: GND, Pin 2: Negative signal (-), Pin 3: Positive signal (+)
  - 5 pin XLR: Pin 1: GND, Pin 2: Negative signal (-), Pin 3: Positive signal (+)

## Warning

- ◆ To prevent or reduce the risk of electrical shock or fire, do not expose the unit to rain or moisture.
- ◆ Never touch bulb with bare fingers as it is very hot after using.
- ◆ Hot lamp explosion hazard. Do not open the unit within five minutes after switching off.
- ◆ Do not start on the unit without bulb enclosure or housing are damaged.
- ◆ The housing, the lenses, or the ultraviolet filter must be replaced if they are visibly damaged.
- ◆ Do not look directly at the light while the bulb is on.

## Caution

There are no user serviceable parts inside the unit. Do not open the housing or attempt any repairs yourself. In the unlikely event your unit may require service, please contact your nearest dealer.



































## Installation

The unit should be mounted via its screw holes on the bracket. Always ensure that the unit is firmly fixed to avoid vibration and slipping while operating. Always ensure that the structure to which you are attaching the unit is secure and is able to support a weight of 20 kgs for each unit.

## 2. Technical Specification

- Voltage: AC 120V~60Hz or 230V/240V/250V~50/60Hz
- Bulb: HID 150W
- The unit is DMX512 fixture. It features full DMX512 control. It can also be linked together in master/slave connection, as many as required in and run by built-in program chase sequences automatically or by sound activation through an internal microphone to create an intelligent effect.
- It can be operated by DMX512 control or can be used as an individual unit without a controller.
- Consistent DMX channel enable iRock, iShow and iMove to be link together.
- Features different preprogrammed chase patterns.
- Please use a 3 pin XLR cable/plug when connecting units together.
- Accurate focusable optics system and ultra smooth stepping motors. Fan cooling.
- Pan : 180 deg. Tilt : 70 deg. **(IR-5S-HID/IR-5B-HID/ IS-6S-HID/IS-6B-HID)**
- **IR-5S-HID/IR-5B-HID** Independent gobo wheel with 14 gobos plus open and blackout, including 11 metal, 2 glass and 1 effect gobos with shaking effect, Independent color wheel with 11 dichroic colors with rainbow effect, and independent shutter
- **IR-4C-HID** Independent gobo wheel with 14 gobos plus open and blackout, including 8 metal, 1 effect, 1 frost, 2 glass, gobos, and 2 color temperature filters (5600k & 3200k), with shaking effect, Independent color wheel with 11 dichroic colors with rainbow effect, and independent shutter & dimmer.
- **IS-6S/6B/4-HID** Professional multi-gobo rotator 14 gobos plus open and blackout, including 11 metal, 2 glass and 1 effect gobos, with shaking and shutter effect, Independent color wheel with 11 dichroic colors with rainbow effect.

## 5.5IS-6S/6B/4-HID ( IS-4-HID is a 4 channel gobo rotator )

DMX512 Configuration					
Ch1	Ch2	Ch3	Ch4		
Pan	Tilt	Barrel	Shutter/Shaking	Gobo	
		246-255 Stopped	248-255 Open	255 Fastest speed Gobo change	
		245 Fastest speed clockwise	247 Fastest speed Shaking	128 Slowest speed Gobo change	
				120-127	
				111-119	
		135 Slowest speed clockwise	132 Slowest speed shaking	103-110	
			131 Fastest speed shutter	094-102	
		121-134 Stopped		086-093	
		120 Slowest speed counterclockwise		077-085	
			16 Slowest speed shutter	069-076	
			008-015 Open	060-068	
		010 Fastest speed counterclockwise	000-007 Blackout	052-059	
		000-009 Stopped		043-051	
				035-042	
				026-034	
				018-025	
				009-017	
				000-008	
Ch5			Ch6		
Color			Reflector		
Normal	Split				
255 Fastest speed Rainbow effect	255 Fastest speed Rainbow effect	246-255 Stopped			
		245 Fastest speed clockwise			
128 Slowest speed Rainbow effect	128 Slowest speed Rainbow effect				
118-127 Pink	121-127 Pink				
107-117 Yellow	113-120 Yellow+Pink	135 Slowest speed clockwise			
096-106 Orange	106-112 Yellow	121-134 Stopped			
086-095 Light Green	098-105 Orange+Yellow	120 Slowest speed counterclockwise			
075-085 UV Purple	091-097 Orange				
064-074 Blue	083-090 Light Green+Orange				
054-063 Red	076-082 Light Green	010 Fastest speed counterclockwise			
043-053 Amber	068-075 UV Purple	000-009 Stopped			
032-042 Light Blue	061-067 Blue				
022-031 Magenta	053-060 Red+Blue				
011-021 Green	046-052 Red				
000-010 White	038-045 Amber				
	031-037 Light Blue				
	023-030 Magenta				
	016-022 Green+Magenta				
	008-015 Green				
	000-007 White				

5B

## 5.5IR-5S/ 5B/4C-HID ( IR-4C-HID is a 4 channel color changer)

DMX512 Configuration							
Ch1		Ch2		Ch3		Ch4	
Pan	Tilt	Barrel		Shutter/Shaking		Gobo	
		246-255 Stopped		248-255 Open		IR-5S/5B-HID	IR-4C-HID
		245 Fastest speed clockwise		247 Fastest speed Shaking		255 Fastest speed Gobo change	
						128 Slowest speed Gobo change	
		135 Slowest speed clockwise		132 Slowest speed shaking		120-127	
		121-134 Stopped		131 Fastest speed shutter		111-119	
		120 Slowest speed counter clockwise		16 Slowest speed shutter		103-110	
				008-015 Open		094-102	
		010 Fastest speed counterclockwise		000-007 Blackout		086-093	
		000-009 Stopped				077-085	
						069-076	
						060-068	
						052-059	
						043-051	
						035-042	
						026-034	
						018-025	
						009-017	
						000-008	
Ch5				Ch6		Ch7	
Normal		Split		No function		Dimmer	
255 Fastest speed Rainbow effect		255 Fastest speed Rainbow effect				255 0%	
128 Slowest speed Rainbow effect		128 Slowest speed Rainbow effect					
118-127 Pink		121-127 Pink					
107-117 Yellow		113-120 Yellow+Pink					
096-106 Orange		106-112 Yellow					
086-095 Light Green		098-105 Orange+Yellow					
075-085 UV Purple		091-097 Orange					
064-074 Blue		083-090 Light Green+Orange					
054-063 Red		076-082 Light Green					
043-053 Amber		068-075 UV Purple					
032-042 Light Blue		061-067 Blue					
022-031 Magenta		053-060 Red+Blue					
011-021 Green		046-052 Red					
000-010 White		038-045 Amber					
		031-037 Light Blue					
		023-030 Magenta					
		016-022 Green+Magenta					
		008-015 Green					
		000-007 White					

## 2.2 Beam Angel

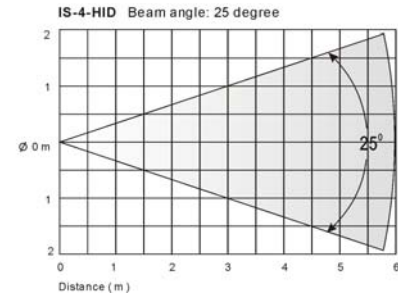
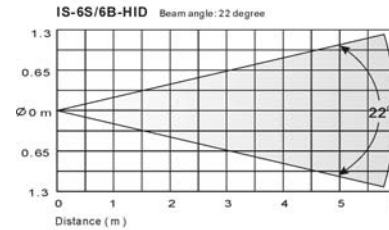
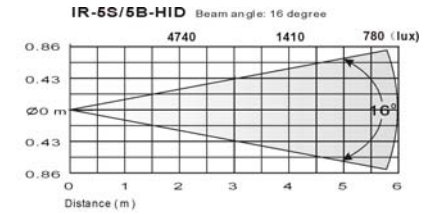
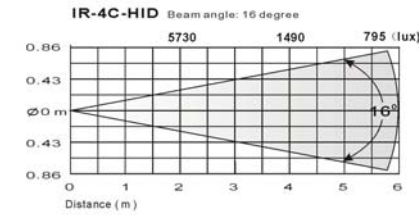

## 3. Lamp

6B



In case of replacement of the lamp or maintenance, do not open the fixture within 15 minutes until the unit cools down after switching

### HID 150W

1. Always switch off the main supply and never handle the lamp or luminaries when is hot.
2. Do not touch the bulb with bare hands. If this happens, clean the lamp with denatured alcohol and wipe it with a lint free cloth before installation.
3. The lamp generates UV radiation. Never operate the lamp without appropriate shielding.
4. When burning, the lamp operates at high pressure and there is a slight risk of arc tube rupture. The risk increases with age, temperature and improper handling of the lamp. Do not use the lamp any longer than its specified life.

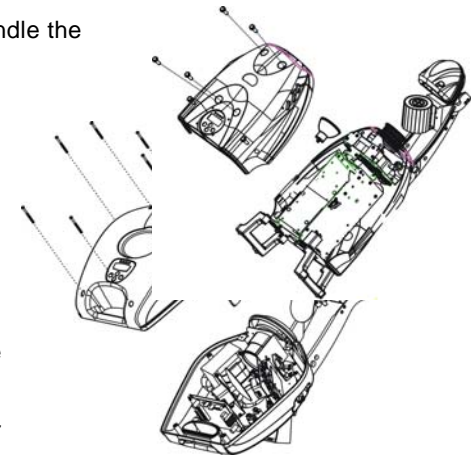

## HID 150 Lamp installation or replacement

- Always switch power off before installing or replacing the lamp. Never try to replace the lamp when it is hot.
- Do not touch the bulb with bare hands. Cleaning the lamp with denatured alcohol and wipe with a lint free cloth when lamp is dirty.

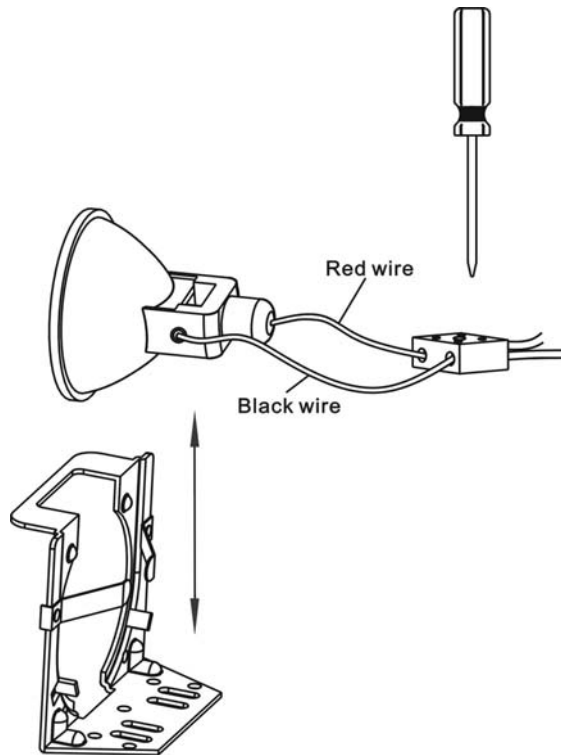

1. Loosen the screw on the housing cover.
2. Loosen the screws of the lamp wire from the terminator.
3. Remove the old lamp from the fixture.
4. Please be careful to install the lamp into the case, make sure it wedges tightly so that it cannot move easily. **WARNING:** Improper installation will cause the lamp's lifespan to shorten and may cause an explosion during operation.
5. Connect the lamp wire to the terminator as before.
6. Please reinstall step 2 and step 1.

## 5.4 DMX512 Configuration

Model	CH1	CH2	CH3	CH4	CH5	CH6
IR-5S-HID	Pan	Tilt	Shutter /Shaking	Gobo	Color	
IR-5B-HID	Pan	Barrel Rotation	Shutter /Shaking	Gobo	Color	
IR-4C-HID	Shutter /Shaking	Gobo	Color	No Function	Dimmer	
IS-6S-HID	Pan	Tilt	Shutter /Shaking	Gobo	Color	Reflector
IS-6B-HID	Pan	Barrel Rotation	Shutter /Shaking	Gobo	Color	Reflector
IS-4-HID	Shutter /Shaking	Gobo	Color	Reflector		

### 5.3.1 iSolution Operation

- ◆ Consistent DMX configuration enable iRock and iShow to be linked together and controlled at the same time.
- ◆ DMX address can be set remotely by iLead controller ( please refer to the user manual of iLead controller ). No need to calculate the DMX channels of each fixture in the chain.
- ◆ Automatic switching between DMX function and built-in stand alone programs.

### 5.3.2 DMX Controller

An universal DMX controller to control the units, you have to set DMX address from 1 to 512 channel so that the units can receive DMX signal.

Press the **MENU** button up to when the **Addr** is showing on the display. Pressing **ENTER** button and the display will blink. Use **DOWN** and **UP** button to change the DMX512 address. Once the address has been selected, press and keep **ENTER** button pressed up to when the display stops blinking or storing automatically 8 seconds later. To go back to the functions without any change press the **MENU** button again.

Please refer to the following diagram to address your DMX512 channel for the first 4 units. DMX address can be set remotely by IL-0824 controller. No need to calculate the DMX channels of each fixture in the chain.

( Following DMX address setting is based on that all the lighting fixtures are linked together controlled by the 8-channel iLead IL-0824 controller. )

#### IR-5S-HID/IR- 5B-HID/IS-6S-HID/IS-6B-HID:



#### IR-4C-HID/IS-4-HID :



## 4. How To Set The Unit

### 4.1 Control Panel

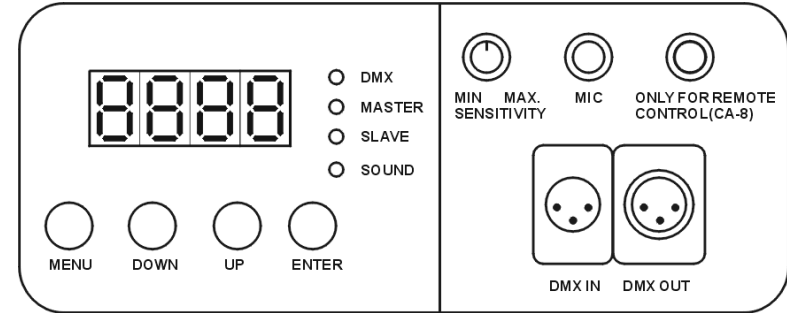

#### Display

To show the various menu and the selected functions.

#### LED

DMX	On	DMX input present
MASTER	On	Master Mode
SLAVE	On	Slave Mode
SOUND	Flashing	Sound activation

8B

#### Button

MENU	to select the programming functions
DOWN	to go backward in the selected functions
UP	to go forward in the selected functions
ENTER	to confirm the selected functions

#### Remote controller input

By connect to the 1/4" microphone jack to control the unit for Stand by, Function and Mode.

#### Sensitivity

To adjust the sound sensitivity.

#### Microphone

To receives audio signal for sound activation.

#### DMX input/output

For DMX512 link, use 3-pin XLR plug cable to link the unit together.



## 4.2 Main Function

To select any of the given functions, press the **MENU** button up to when the required one is showing on the display. Select the function by **ENTER** button and the display will blink. Use **DOWN** and **UP** button to change the mode. Once the required mode has been selected, press the **ENTER** button to setup or it will automatically return to the main functions without any change after idling 8 seconds. To go back to the functions without any change press the **MENU** button. The main functions are showing below:

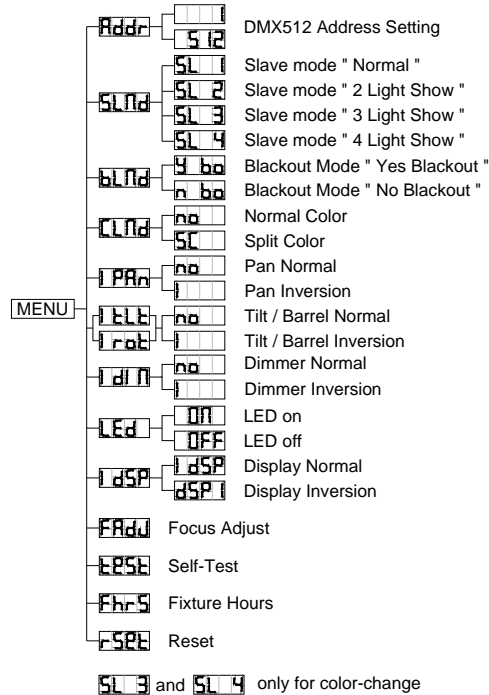

### Addr DMX512 Address Setting

Press the **MENU** button up to when the **Addr** is showing on the display. Pressing **ENTER** button and the display will blink. Use **DOWN** and **UP** button to change the DMX512 address. Once the address has been selected, press the **ENTER** button to setup or automatically return to the main functions without any change after 8 seconds. To go back to the functions without any change press the **MENU** button again.

### SLnd Slave Mode

## 5.2 Easy Controller

The easy remote control is used only in master/slave mode. By connecting to the 1/4" microphone jack of the first unit, you will find that the remote control on the first unit will control all the other units as below.

Built-in lighting shows triggered by Easy Controller:

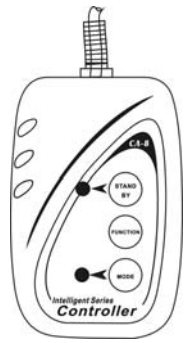

9B

IR-5S-HID IR-5B-HID	Stand by	Blackout the unit			
	Function	Strobe 1.Gobo/Color sync. strobe 2.Sync. strobe 3.Two-light strobe	X/Y moving pattern selection ( 12 patterns )	Color/Gobo selection 1. Hold on for gobo change. 2. Press shortly for color change.	X/Y moving setting 1.Pan position 2.Tilt position 3.Dimmer
	Mode	Sound 1 (LED off )	Sound 2 (LED normal blinking)	Slow/Sound 3 (LED on)	Position/ Latch (LED fast blinking )
IR-4C-HID	Stand by	Blackout the unit			
	Function	Strobe 1.Gobo/Color sync. strobe 2.Sync. strobe 3.Two-light strobe	Chase pattern selection ( 6 patterns )	Color/Gobo selection 1. Hold on for gobo change. 2. Press shortly for color change.	Dimmer setting
	Mode	Sound 1 (LED off )	Sound 2 (LED normal blinking)	Slow (LED on)	Latch (LED fast blinking )
IS-6S-HID IS-6B-HID	Stand by	Blackout the unit			
	Function	Strobe 1.Gobo/Color sync. strobe 2.Sync. strobe 3.Two-light strobe	X/Y moving pattern selection ( 12 patterns )	Color/Gobo selection 1. Hold on for gobo change. 2. Press shortly for color change.	X/Y moving setting 1.Pan position 2.Tilt position
	Mode	Sound 1 (LED off )	Sound 2 (LED normal blinking)	Slow/Sound 3 (LED on)	Position/ Latch (LED fast blinking )
IS-4-HID	Stand by	Blackout the unit			
	Function	Strobe 1.Gobo/Color sync. strobe 2.Sync. strobe 3.Two-light strobe	Gobo/Color selection 1.Hold on for gobo change. 2.Press shortly for color change.		
	Mode	Sound (LED off )	Slow (LED on)		

X/Y moving pattern



## 5. How To Control The Unit

You can operate the unit in three ways:

1. By master/slave built-in preprogram function
2. By easy controller
3. By IL-0824 ( please refer to the user guide of iLead controller ) or universal DMX controller

No need to turn the unit off when you change the DMX address, as new DMX address setting will be effected at once. Every time you turn the unit on, it will show its item number on the display and move all the motors to their 'home' position and you may hear some noises for about 20 seconds. After that the unit will be ready to receive DMX signal or run the built in programs.

### 5.1 Master/Slave Built In Preprogrammed Function

By linking the units in master/slave connection, the first unit will control the other units to give an automatic, sound activated, synchronized light show. This function is good when you want an instant show. Its DMX input jack will have nothing plugged into it, and its master LED will be constantly on and sound LED will flash to the music. The other units will have to set in slave mode **SLNd** and select **SL01** (normal) or **SL02** (2 light show) mode **SL03** (3 light show) mode or **SL04** (4 light show), Their DMX cables plugged into the DMX input jacks (daisy chain) and the slave led lights will constantly on.

**SL03** and **SL04** only for color-change.

#### 2-light show

In **SLNd** (slave mode), **SL01** means the unit works normally and **SL02** means 2-light show. In order to create a great light show, you can set **SL02** on the second unit to get contrast movement to each other, even if you have two units only.

Press the **MENU** button up to when the **SLNd** is showing on the display. Pressing **ENTER** button and the display will blink. Use **DOWN** and **UP** button to select the **SL01** (normal) or **SL02** (2 light show) mode or **SL03** (3 light show) mode or **SL04** (4 light show). Once the mode has been selected, press the **ENTER** button to setup or automatically return to the main functions without any change after 8 seconds. To go back to the functions without any change press the **MENU** button again.

#### **bLNd** Blackout Mode

Press the **MENU** button up to when the **bLNd** is showing on the display. Pressing **ENTER** button and the display will blink. Use **DOWN** and **UP** button to select the **y bo** (yes blackout) or **n bo** (no blackout) mode. Once the mode has been selected, press the **ENTER** button to setup or automatically return to the main functions without any change after 8 seconds. To go back to the functions without any change press the **MENU** button again.

#### **CLNd** Color Mode

Press the **MENU** button up to when the **CLNd** is showing on the display. Pressing **ENTER** button and the display will blink. Use **DOWN** and **UP** button to select the **no** (normal) or **SC** (split color) mode. Once the mode has been selected, press the **ENTER** button to setup or automatically return to the main functions without any change after 8 seconds. To go back to the functions without any change press the **MENU** button again.

#### **iPANn** Pan Inversion

Press the **MENU** button up to when the **iPANn** is showing on the display. Pressing **ENTER** button and the display will blink. Use **DOWN** and **UP** button to select the **no** (normal) or **i** (pan inversion) mode. Once the mode has been selected, press the **ENTER** button to setup or automatically return to the main functions without any change after 8 seconds. To go back to the functions without any change press the **MENU** button again.

#### **iTLTt** Tilt Inversion      **irot** Barrel Rotation Inversion

Press the **MENU** button up to when the **iTLTt** ( **irot** ) is showing on the display. Pressing **ENTER** button and the display will blink. Use **DOWN** and **UP** button to select the **no** (normal) or **i** (tilt/barrel rotation inversion) mode. Once the mode has been selected, press the **ENTER** button to setup or automatically return to the main functions without any change after 8 seconds. To go back to the functions without any change press the **MENU** button again.

### Dimmer Inversion

Press the **MENU** button up to when the is shown on the display. Pressing **ENTER** button and the display will blink. Use **DOWN** and **UP** button to select the (normal) or (dimmer inversion) mode. Once the mode has been selected, press the **ENTER** button to setup or automatically return to the main functions without any change after 8 seconds. To go back to the functions without any change press the **MENU** button again.

### Led Display

Press the **MENU** button up to when the is showing on the display. Pressing **ENTER** button and the display will blink. Use **DOWN** and **UP** button to select the (Led on) or (Led off) mode. Once the mode has been selected, press the **ENTER** button to setup or automatically return to the main functions without any change after 8 seconds. To go back to the functions without any change press the **MENU** button again.

### Display Inversion

It is good for you to install the unit on the floor or under ceiling. Press the **MENU** button up to when the is blinking on the display. Use the **ENTER** button to change to the mode (display inversion), It will automatically store after 8 seconds. Or press the **ENTER** button again return to the mode (display normal). To go back to the functions press the **MENU** button again.

Display normal mode for the fixture putting on the floor.

Display inversion mode for the fixture fixing under ceiling.

### Focus Adjust

Press the **MENU** button up to when the is blinking on the display. Pressing **ENTER** button, the unit will focus on center position. To go back to the functions press the **MENU** button again.

### Self-Test

Press the **MENU** button up to when the is blinking on the display. Pressing **ENTER** button and the unit will run self-test by built in program. To go back to the functions press the **MENU** button again.

### Fixture Hours

Press the **MENU** button up to when the is blinking on the display. Pressing **ENTER** button and the display will show the number of working hours of the unit. To go back to the functions press the **MENU** button again.

### Reset

Press the **MENU** button up to when the is blinking on the display. Pressing **ENTER** button and all channels of the unit will return to their standard position. To go back to the functions press the **MENU** button again.